

GROUP 2 TRANSMISSION

1. TECHNICAL DATA

Rated input power	154 kW
Rated input speed	2200 rpm
Torque converter mode	Single-stage, two-phase, four-element
Torque ratio when zero speed	4 ± 0.20
Transmission Type	Two forward and one reverse gears, power shift, planetary structure
Mechanical Gear Ratio; Gear I	2.155
Gear II	0.578
Reverse	1.577
I/O gear ratio of P.T.O	P.T.O. 1 1.0
	P.T.O. 2 1.167
Hydraulic oil pressure	1.10 ~ 1.40 MPa
Inlet oil pressure, torque converter	0.30 ~ 0.45 MPa
Outlet oil pressure, torque converter	0.20 ~ 0.30 MPa
Lubricating oil pressure	0.10 ~ 0.20 MPa
Max. permissible tempeture at outlet of torque converter	120°C

2. STRUCTURAL PRINCIPLE

Hydraulic transmission consists of hydraulic torque converter and power-shifting mechanical transmission. The transmission diagram is as shown as figure 3.

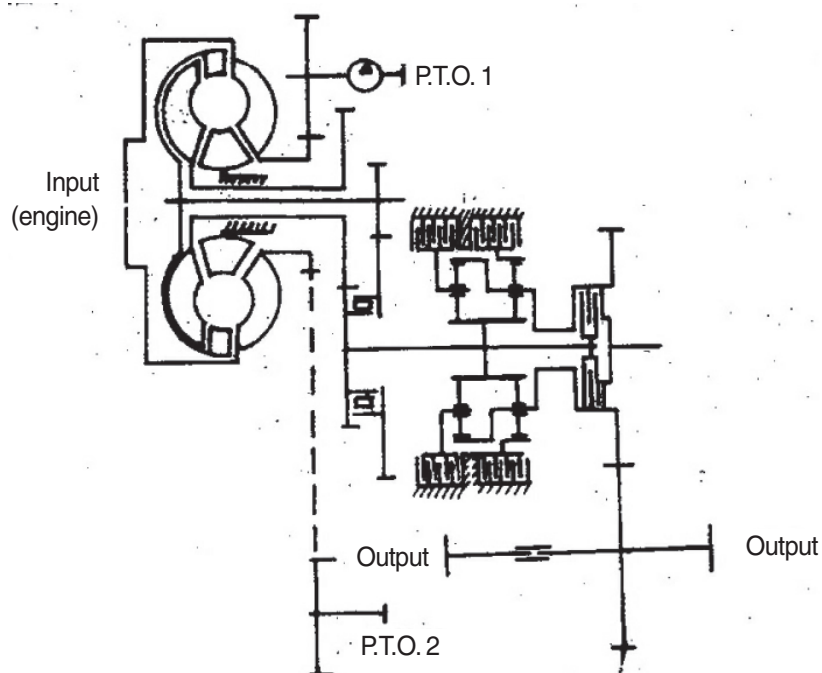
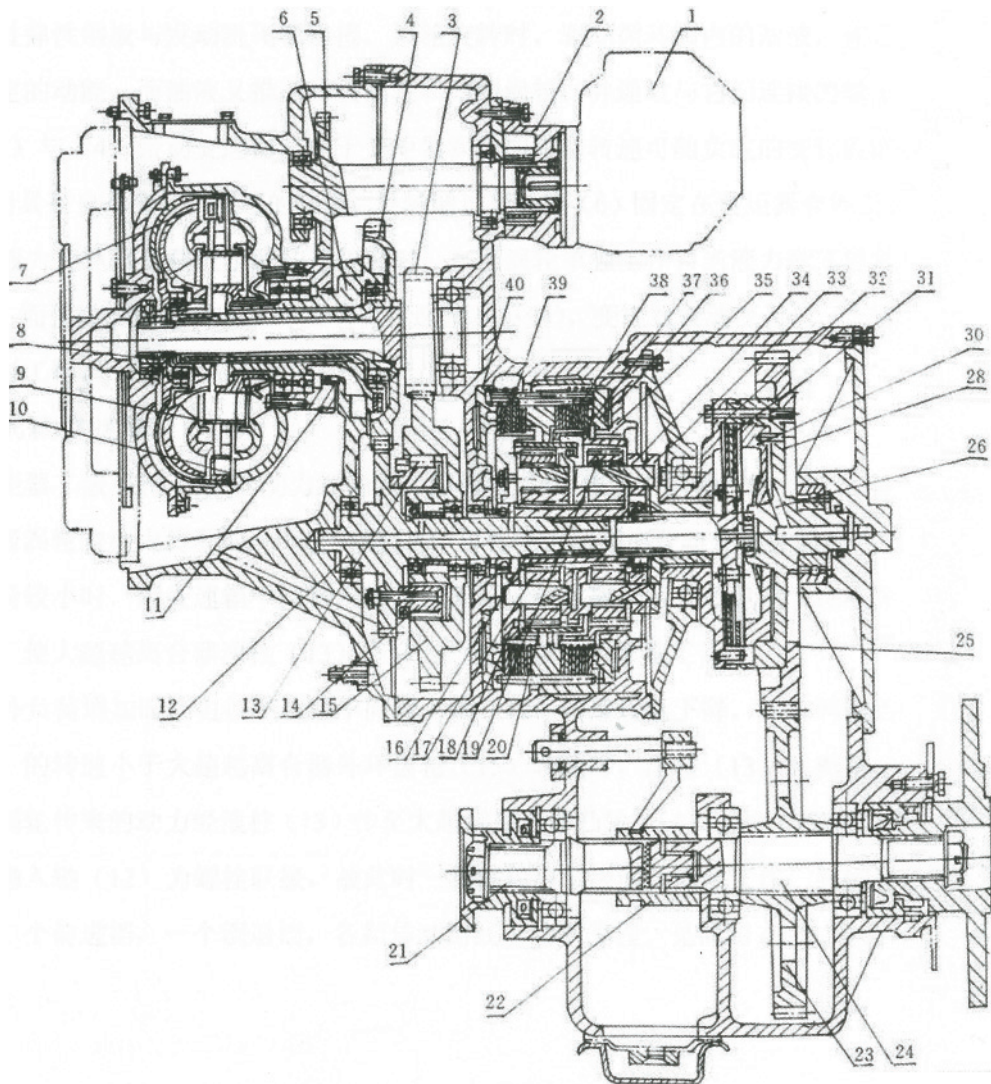

Figure 3 Structural diagram of hydraulic transmission.

3. STRUCTURE



850KTM100

- | | | |
|-----------------------------|----------------------------------|-----------------------------------|
| 1 Working pump | 14 Large overrunning clutch cam | 26 Direct gear input shaft |
| 2 Variable speed pump | 15 Outer-ring gear, large over- | 28 Direct gear cylinder |
| 3 First-stage input gear | running clutch | 30 Direct gear piston |
| 4 Input second-stage gear | 16 Sun gear | 31 Direct gear frictional plate |
| 5 Shaft gear | 17 Reverse planet wheel | 32 Direct gear thrust plate |
| 6 Guide pulley seat | 18 Reverse pinion carrier | 33 Reverse-gear I connection disc |
| 7 Second-stage turbine | 19 Gear I planet gear | 34 Gear I pinion carrier |
| 8 First-stage turbine | 20 Reverse inner toothed annulus | 35 Gear I cylinder |
| 9 Guide pulley | 21 Rear axle output shaft | 36 Gear I piston |
| 10 Pump pulley | 22 Front back release sliding | 37 Gear I inner toothed annulus |
| 11 Transfer gear | sleeve | 38 Gear I frictional plate |
| 12 Intermediate input shaft | 23 Output gear, transmission | 39 Reverse frictional plate |
| 13 Large overrunning clutch | 24 Front axle output shaft | 40 Reverse piston |
| roller | 25 Output gear | |

4. OUTSIDE VIEW

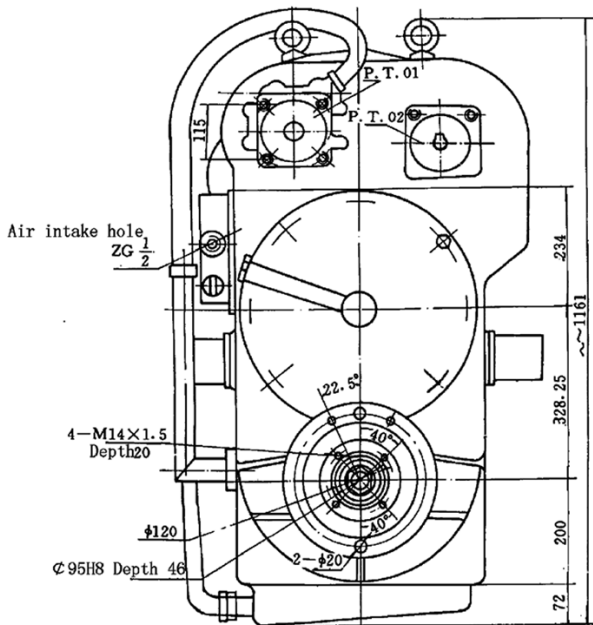
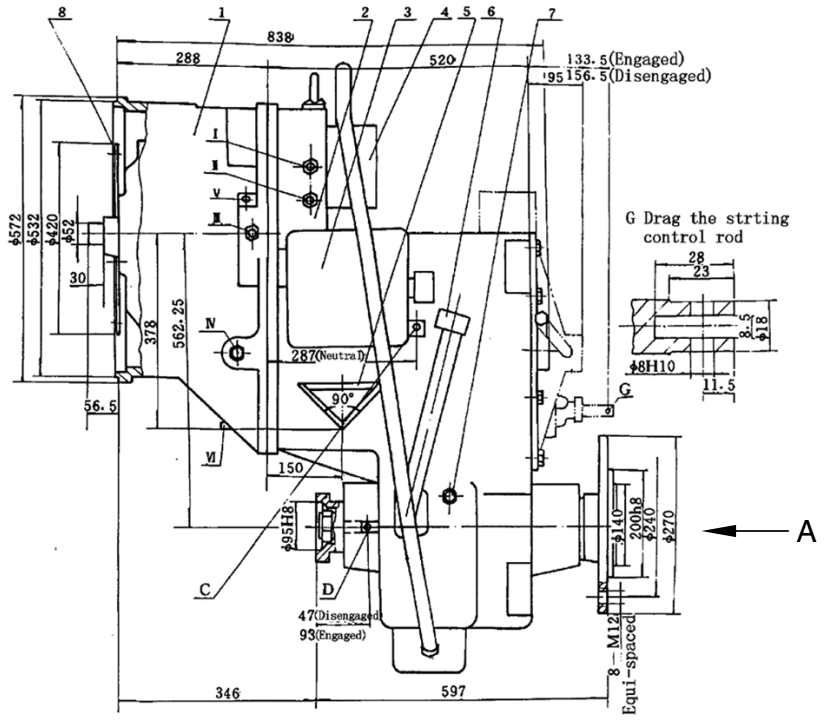
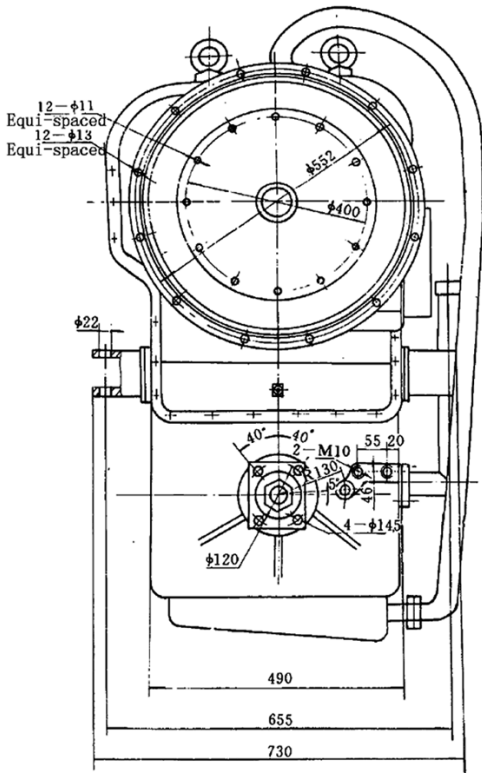

VIEW A

P.T.O.1 Connection seat for Working pump

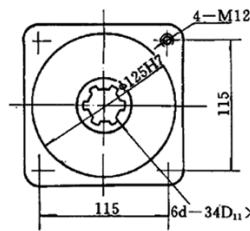

P.T.O.2 Connection seat for steering pump

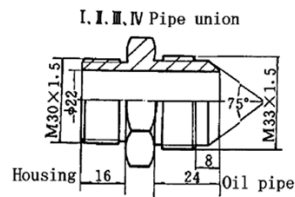
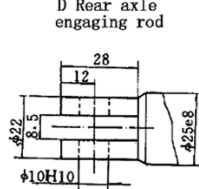
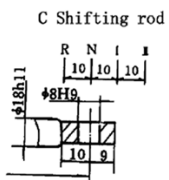
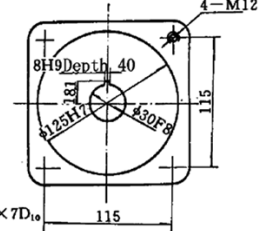

V. Interface for oil thermometer M14×1.5 Depth 20

5. OPERATION

1) HYDRAULIC TORQUE CONVERTER

Torque converter is designed as single-stage, two-phase and four elements. Its construction is as shown in figure 2 (page 2-3).

Torque converter consists mainly of pump pulley (10), first-stage turbine (8), second-stage turbine (7) and guide pulley (9). The pump pulley connects to engine flywheel by a flexible steel board. When the pump pulley turns, oil in torus is driven and has certain kinetic energy. Then the oil drives the first- and second-stage turbines, and drives the transmission running. Since turbines' torque and speed would change by variation of load, the torque converter possesses the functions of automatic torque- and speed-changing. The guide pulley is fixed on housing of torque converter by a guide pulley seat (6).

When hydraulic transmission has a small load or high speed, the second-stage turbine works individually; however, when the load increases and the speed decreases (at the moment the speed of motor is basically unchanged), two turbines automatically work together.

2) MECHANICAL TRANSMISSION

Power of the second-stage turbine (7) is transferred to intermediate input shaft (12) via input second-stage gear (4), and that of the first-stage turbine to input first-stage gear (3), then to outer-ring gear of large overrunning clutch (15). When external load is comparatively small, speed of intermediate input shaft (12) is higher than that of outer-ring gear of large overrunning clutch (15), thus making large overrunning clutch roller (13) racing. At this time the second-stage turbine works individually.

When external load is increasing, speed of intermediate input shaft (12) is caused to descend gradually. If speed of the intermediate input shaft (12) is lower than that of outer-ring gear of large overrunning clutch (15), the roller (13) is to be wedged. Power from the first-stage turbine is transferred to large overrunning clutch cam (14) via the roller (13). Since the cam (14) and the intermediate input shaft (12) are connected with bolts, the first- and the second-stage turbines work together at the time. Mechanical transmission has two forward gears and one reverse gear. Transmission route and power flow chart of each gear are as shown in figure 4, 5 and 6.

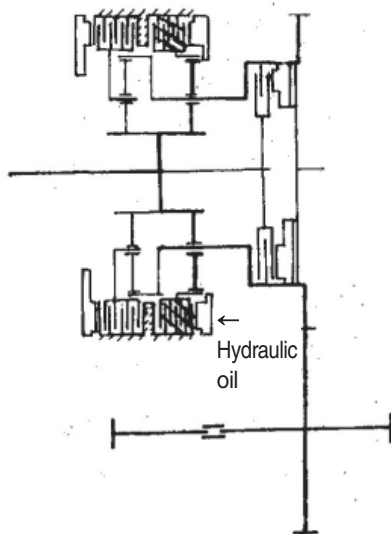

Figure 4 Power flow chart of forward gear I

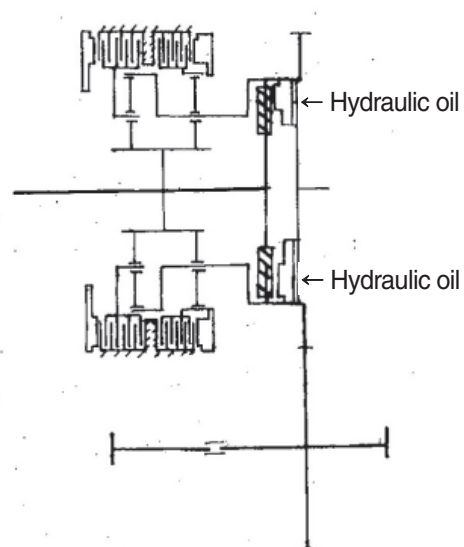

Figure 5 Power flow chart of forward gear II

At the bottom of the transmission, there is a front and rear axle release device (see to figure 2), which can control single- or dual-axle drive. Pull the control rod outward for single-axle drive and push inside for dual-axle drive. Generally, use single-axle drive in long-distance transport with light load to reduce loss from power recycling; and use dual-axle drive when operating under heavy load on slushy roads or crossing bridges.

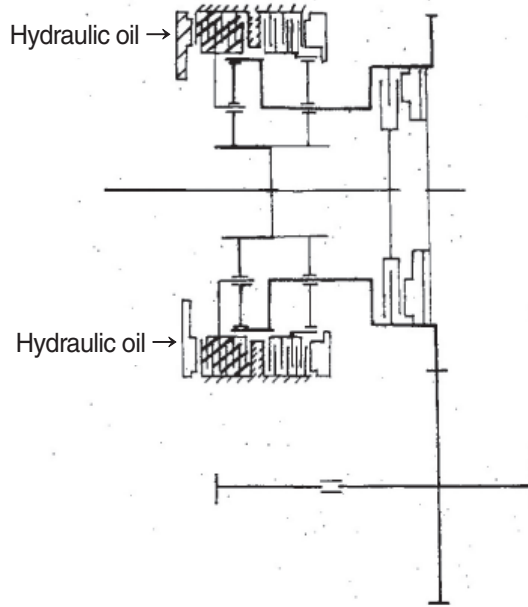

Figure 6 Diagram of reverse gear power flow chart

3) HYDRAULIC SYSTEM

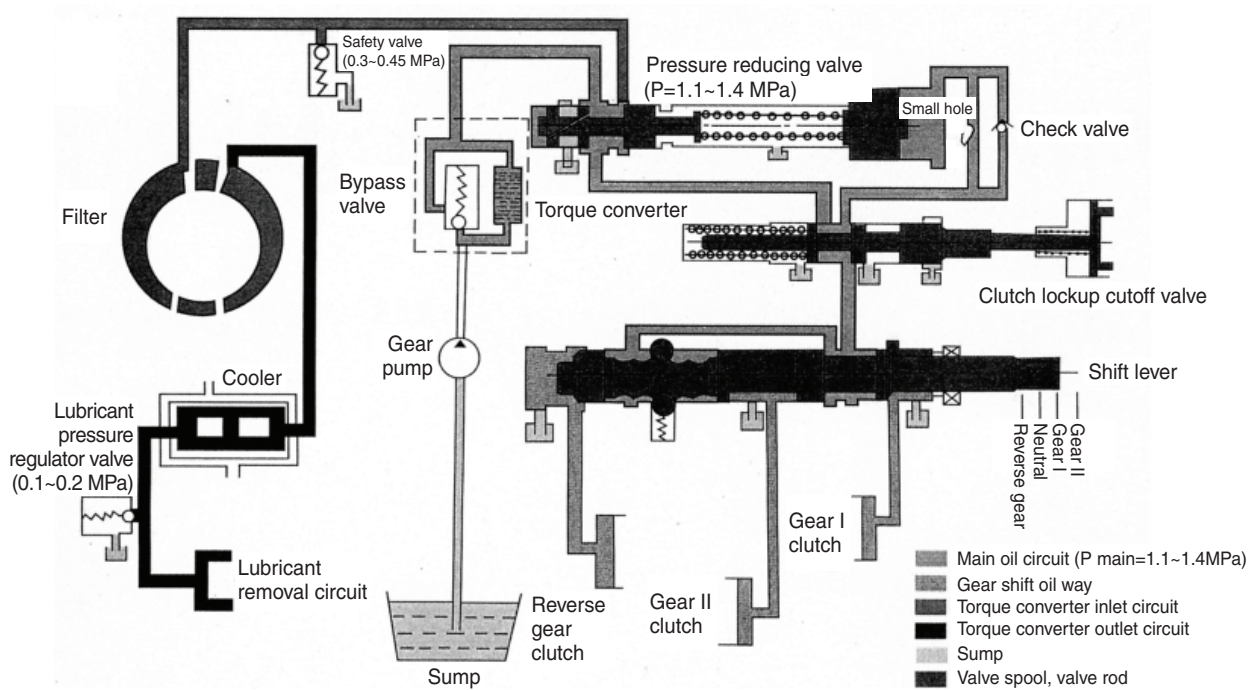

Diagram of hydraulic system of hydraulic transmission

850KPT51

6. APPLICATION AND INSTALLATION

1) INSTALLATION AND CONNECTION

(1) Connection to engine

Surface of torque converter casing is directly connected to that of engine flywheel casing by bolts. Through the connection between flexible steel board of converter and engine flywheel by stud bolts and nuts, power is transferred. Head of centering shaft at front end of pump pulley cover inserts flywheel centering hole as centering.

When installing, screw stud bolts into flywheel, open a chock on torque converter, lift the transmission and make hole on flexible steel board and centering hole lining up, screw end-face bolts and tighten the nuts through square holes at lower side of the chock, at last, cover the chock.

※ Difference between the plane of flywheel casing and that of flywheel ≤ 0.50 mm.

(2) Connection to oil pump

Working oil pump and steering oil pump are directly mounted onto PTO1 and PTO2 of transmission. (Shaft head length 60~65 mm, key connection useful length ≥ 40 mm).

※ Connection parameter must be correct.

(3) Installation on vehicle

Had better apply three- or four-point flexible supporting installation. There is each one V-block at both sides of transmission for installation and it's required to weld corresponding V-blocks on the vehicle body, too. Between two V-blocks insert a rubber plate of 10~12 mm as elastic layer, avoiding stress from vehicle chassis being transmitted to transmission housing directly.

(4) Selection and assembly of filter

Select filter meeting parameter as follows : Min. filter flow: 120 ℓ/min

Filter accuracy not less than 150 mesh/inch. Use sintered filter as far as possible.

The installation height of filter and oil pipes must not be higher than that of the oil pipe connector of housing.

(5) Selection and assembly of cooler

Calculate cooling capacity required on the basis of an ambient temperature 30, which should be 35~40% of the rated power of engine. Normal flow must be assured.

Cooler for transmission should be located at cool water end of the cooling system.

Diameter of oil pipe and thread connector for cooler and filter should be more than 20, and when oil pipe exceeds 1m in length, the value increases by 20%.

※ The system maker is liable for correct installation.

2) APPLICATION REQUIREMENTS

(1) After installation of hydraulic transmission, fill in about AFT (DEXRON III) from the oil hole. Check the oil level again after 5min running from starting engine, which should reach the height of oil-level plug. During checking, be sure to take safety measures to avoid vehicle moving or rolling.

(2) Oil level should be checked before each shift operating.

(3) When the transmission works, the hydraulic oil pressure should be kept within 1.1~1.4 MPa. In case of the value is lower than 1 MPa or higher than 1.6 MPa, stop and check to avoid damaging the parts inside.

- (4) The oil temperature should be lower than 120°C. When it exceeds, keep the engine speed within 1200~1500 rpm and make the transmission at neutral, then the oil temperature should decrease to a normal value in 2~3 min. If not, it shows there are problems in the system, which must be resolved before operation.
- (5) Reduce machine speed before transmission changing down. And stop before reversing.
- (6) The shifting lever should be at neutral position when starting the engine.
- (7) Stop when control by using the axle releasing device.
After installation of a new T/M, keep running in for twelve hours under a load less than 70%, four hours for each of three gears. Check the oil temperature, oil pressure and the tightness of bolts. After running in, clean the sump strainer of transmission and then renew oil.

3) MAINTENANCE

Maintenance is carried out after running for 50, 250, 1000 and 2000 hours.

- (1) 50 hours maintenance : ① check oil level ② Inspect the control system.
- (2) 250 hours maintenance : Clean filter and clean sump.
- (3) 500 hours maintenance : Change oil.
- (4) 1000 hours maintenance : Replace filter.
- (5) 2000 hours maintenance : Dismantle and inspect the transmission and the torque converter, replace easily-worn parts, regulate or replace parts when necessary.

7. MAIN FAILURES AND REMEDIES

Main Failures	Remedies
The engine rotating, but machine can not run	
<ol style="list-style-type: none"> 1. Did not in any gears 2. Hydraulic oil level too low 3. Brake rod of shift valve can not return 4. Insufficient oil supply due to shifting oil pump damaged or oil seals broken 	<ol style="list-style-type: none"> 1. Put into gear or check if it correct 2. Add oil 3. Dismantle and check the brake rod 4. Replace oil pump or oil seals
Insufficient driving force	
<ol style="list-style-type: none"> 1. Low oil pressure at inlet of torque converter 2. Clutch sliding 3. Insufficient engine speed 	<ol style="list-style-type: none"> 1. Check oil level; clean sump strainer and filter; check the pressure regulating valve of torque converter 2. Inspect clutch oil pressure and piston oil seal 3. Inspect the engine
Variable speed oil pressure too low	
<ol style="list-style-type: none"> 1. Misalignment of reducing valve 2. Obstructed oil filter 3. Damaged oil pump 4. Serious oil leakage in clutch oil seal 	<ol style="list-style-type: none"> 1. Realignment 2. Clean oil filter 3. Replace oil pump 4. Replace oil seals
Oil temperature in torque converter too high	
<ol style="list-style-type: none"> 1. Oil level in transmission too low or too high 2. Clutch sliding 3. Long-time, heavy load operation 	<ol style="list-style-type: none"> 1. Fill oil acc. to specified 2. Check oil pressure of clutch 3. Stop to cool
Can not put into gear after emergent braking	
<ol style="list-style-type: none"> 1. Misalignment limit screws of air brake valve pedal 2. Choked piston of air brake valve. Return is unavailable after release of brake. 3. Choked brake valve rod 	<ol style="list-style-type: none"> 1. Realign the limit screws of pedal so that air brake valve can return completely. 2. Clean and repair the piston 3. Dismantle and check brake valve rod

8. DISASSEMBLY AND ASSEMBLY

1) DISASSEMBLY

- (1) Use a M16 socket wrench to unscrew 6-M10×60 bolts on the interface between oil pump and casing. Use a copper bar to lightly knock on the outside of oil pump and remove the oil pump.

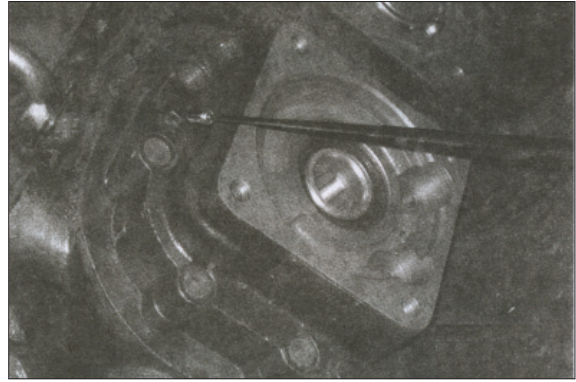

850KTM01

- (2) When assembling, set a paper washer on the surface of oil pump with grease, set 6-M10×60 bolts and fasten up one by one.

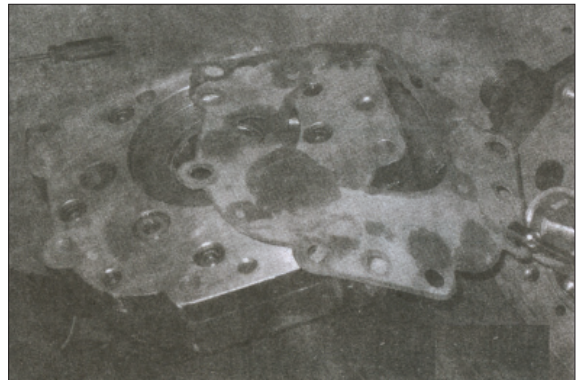

850KTM02

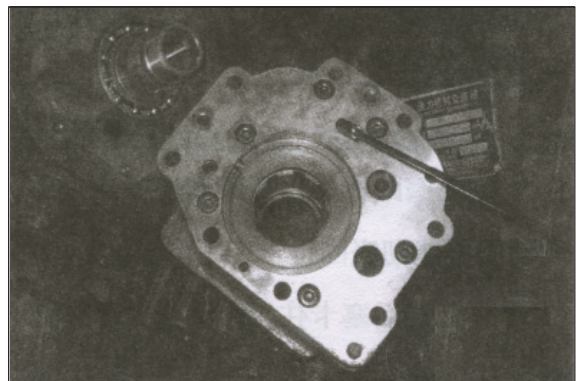

850KTM03

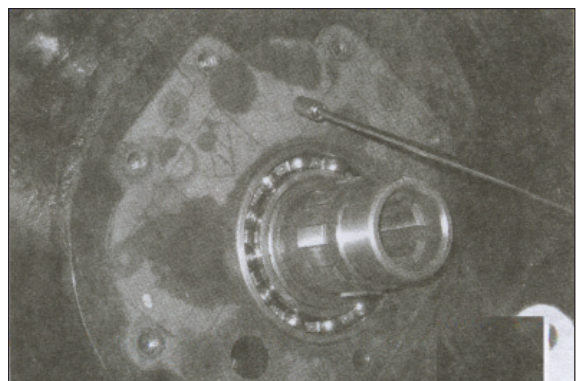

850KTM04

- (3) Use a M16 socket wrench to fasten up 10-M10×70 and 1-M10×65 bolts on the control valve.

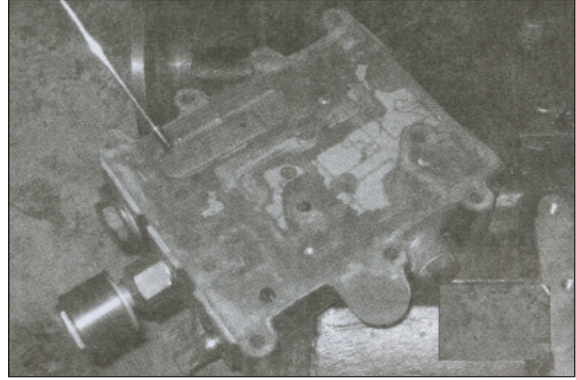

850KTM05

- (4) When assembling, set a paper washer on the surface of casing with grease and mount the control valve. First set a bolt, then insert 10-M10×70 and 1-M10×65 bolts in sequence and fasten up. Be sure that the bolts are fastened from inside to outside not to have the water paper broken.



850KTM06

- (5) Use a M16 socket wrench to unscrew 26-M10×30 and 5-M10×70 jointing the torque converter and transmission. Use 3-M10×70 art bolts to disassemble the torque from the casing.



850KTM07

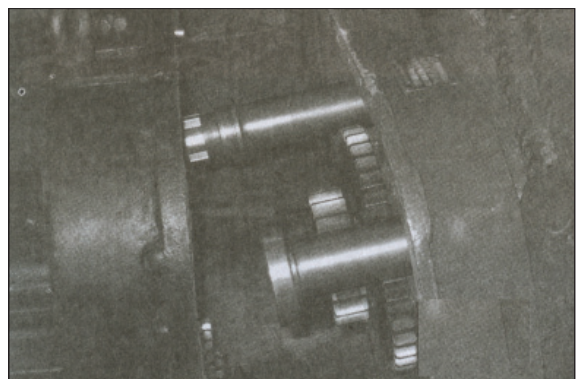

850KTM08

(6) Dismount the bearing seat and torque converter respectively.

1 Bearing seat

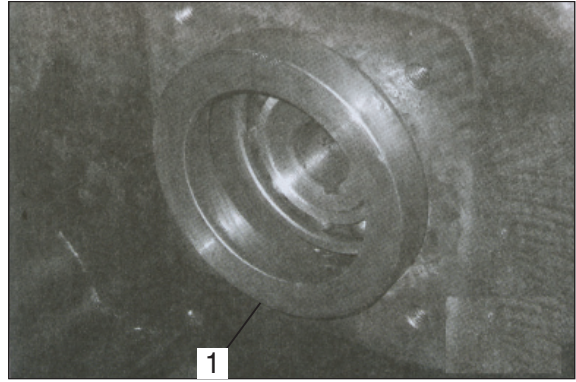

850KTM09

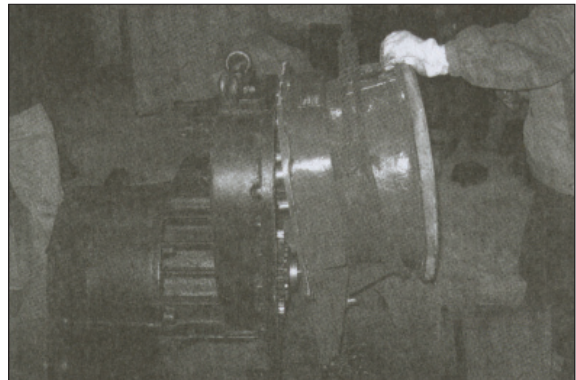

850KTM10

(7) Disassemble the input first and second gears from the torque converter respectively.

1 Input first gear

2 Ball thrust bearing

3 Ball bearing (55×120×29)

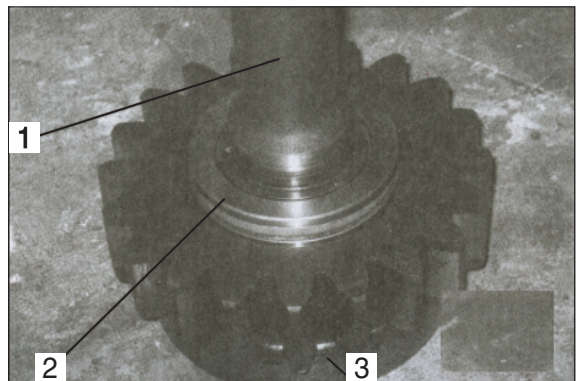

850KTM11

4 Input second gear

5 Oil seal (45×53×5)

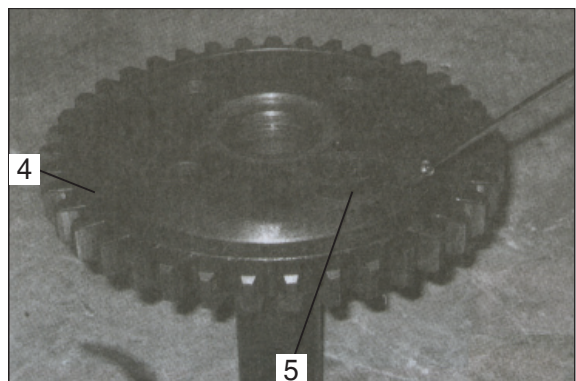

850KTM12

(8) Use a M16 socket wrench to unscrew 26-M10×30 and 5-M10×70 jointing the torque converter and transmission. Use 3-M10×70 art bolts to disassemble the torque from the casing.

- 1 Ball bearing (55×100×21)
- 2 Steering oil pump driving shaft
- 3 Steering oil pump drive gear
- Flat key (14×35)
- Ball bearing (50×90×20)

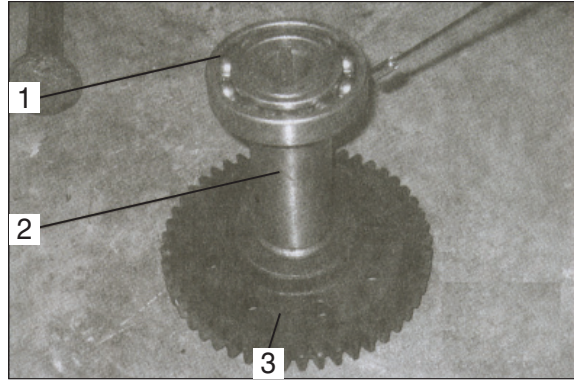

850KTM13

- 4 Ball bearing (60×95×18)
- 5 Gear shaft
- 6 Ball bearing (50×90×20)

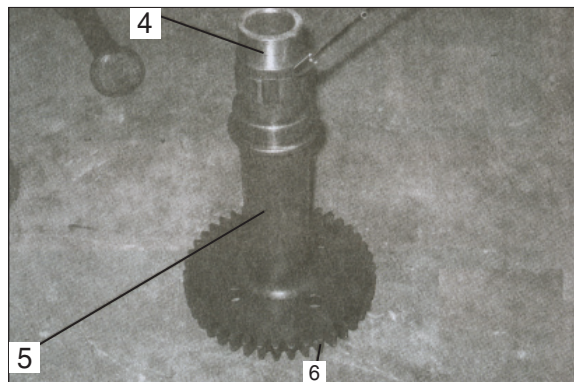

850KTM14

(9) Disassemble biaxial assy.

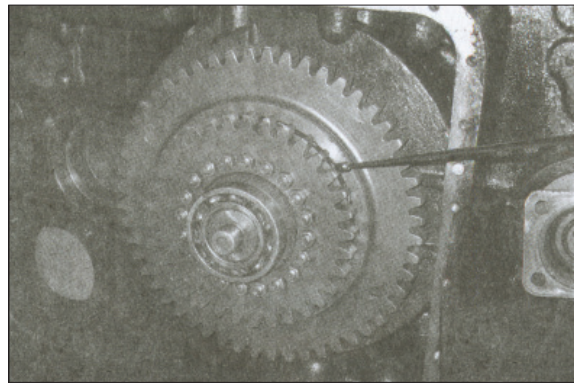

850KTM15

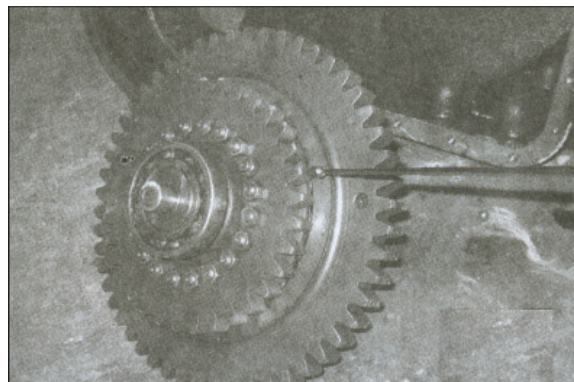

850KTM16

(10) Put the transmission in level position and use a M16 wrench to unscrew 8-M10×30 bolts of end cover. Set two eye bolts into screw hole and remove the end cover.

1 End cover

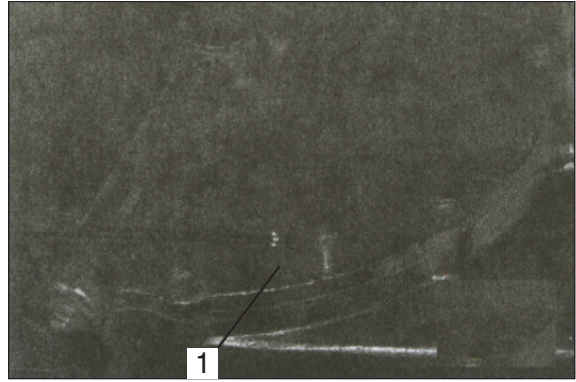

850KTM17

2 Casing

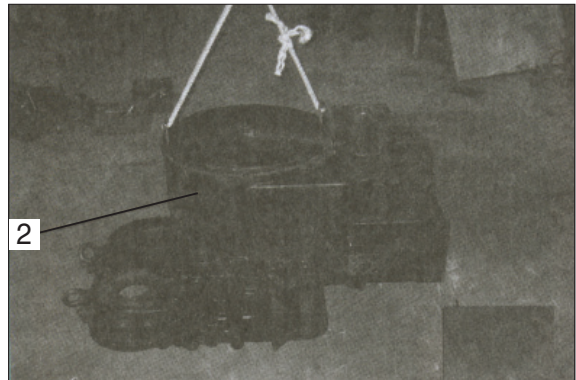

850KTM18

(11) Use two M12 eye bolts to sling the direct gear assy out.

1 Direct gear assy

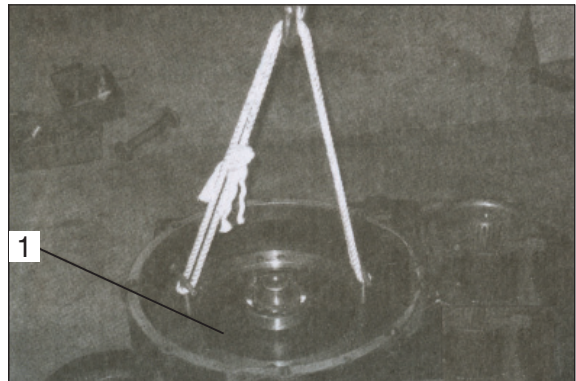

850KTM19

(12) Use a M22 socket wrench to unscrew 8-M14×40 bolts on the mid-cover to remove it.

1 Mid-cover

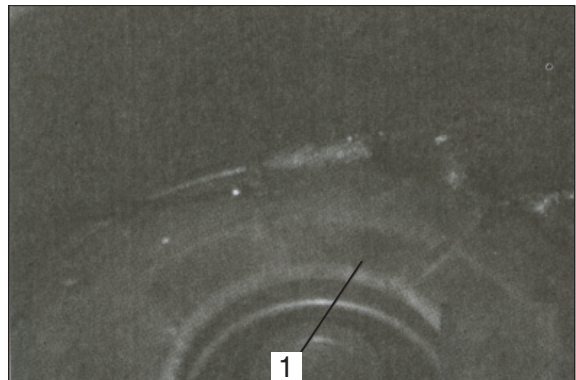

850KTM20

(13) Remove the parts of the planetary gear sets inside transmission, gear I cylinder assy, 15 spring pins, springs, friction discs (4 sets), gear I planet carrier, isolator assy, friction discs (4 sets), reverse gear planet carrier assy and reverse gear piston in sequence.

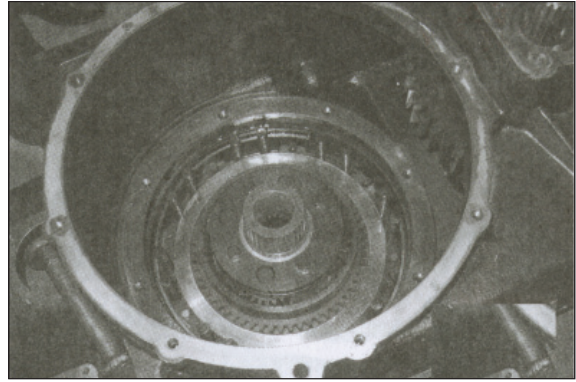

850KTM21

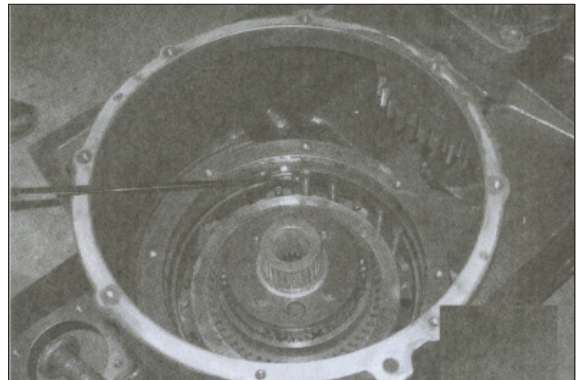

850KTM22

(14) Remove 2 rings 130 at two sides of the casing and knock out the output shaft forward from the rear side.

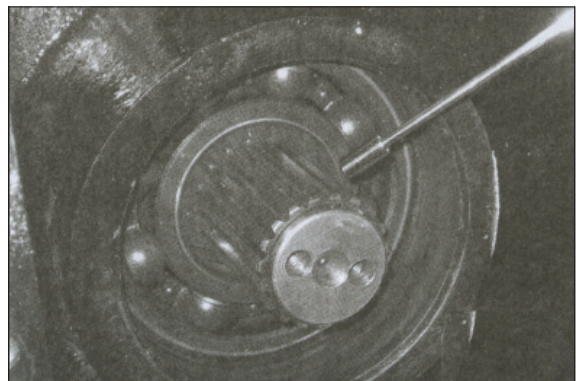

850KTM23

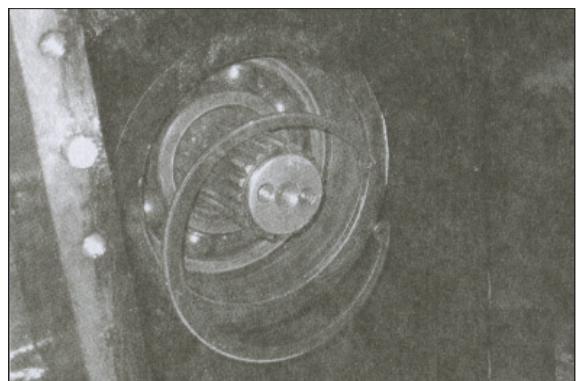

850KTM24

2) ASSEMBLY

- (1) Clean the transmission case, put it in level position, and assemble the reverse gear piston.

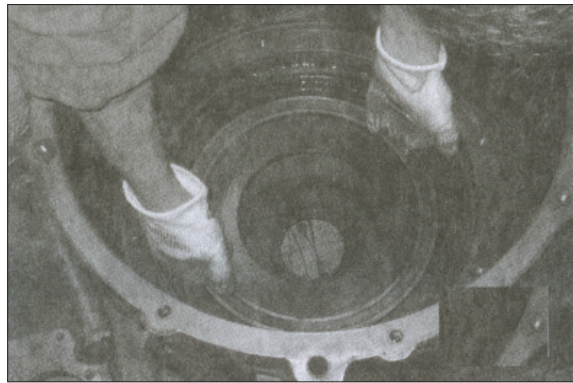

850KTM25

- 1 Reverse gear piston

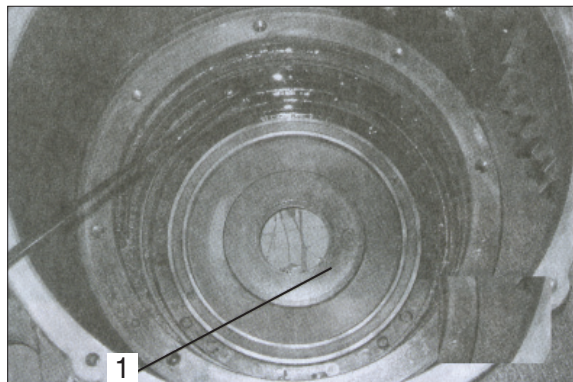

850KTM26

- (2) Assemble reverse planetary gear.

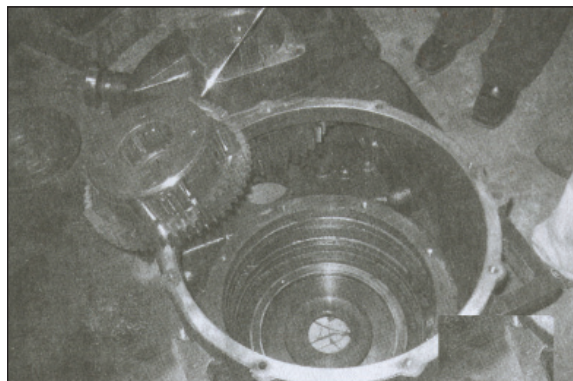

850KTM27



850KTM28

(3) Assemble 4 sets of reverse driven disc and driving disc in sequence.

- 1 Reverse driving disc
- 2 Reverse driven disc

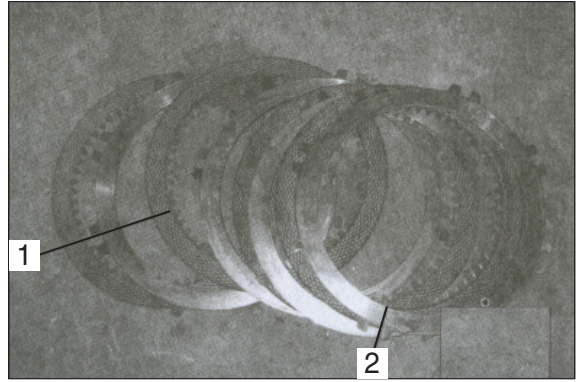

850KTM29

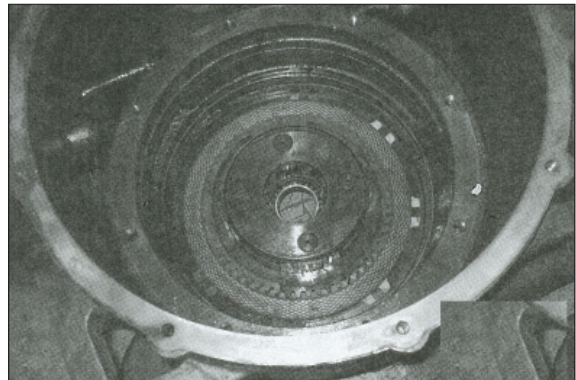

850KTM30

(4) Assemble friction disc isolator assy.

- 1 Friction disc isolator assy

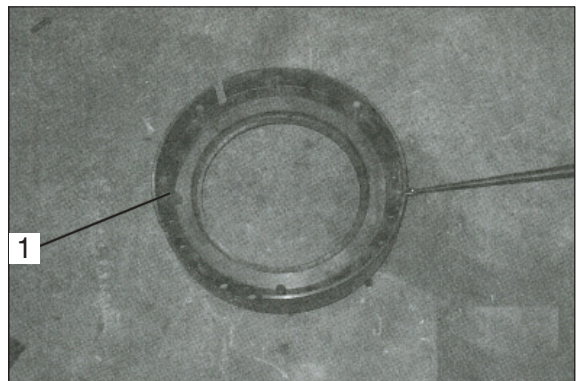

850KTM31



850KTM32

(5) Assemble gear I planet gear carrier assy.

- 1 Pinion carrier
- 2 Reverse ring gear

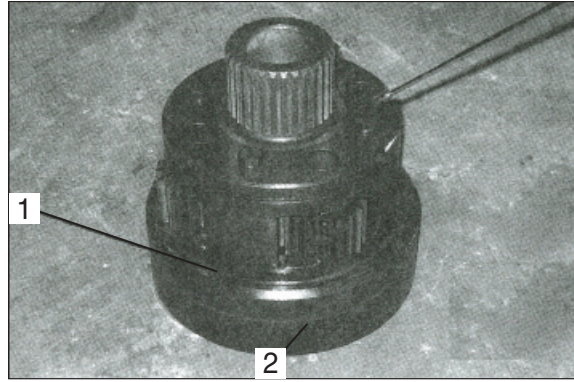

850KTM33

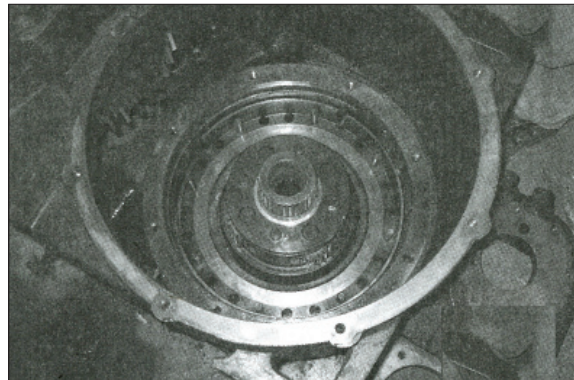

850KTM34

(6) Assemble gear I ring gear and 4 sets of driving disc and driven disc.

- 1 Gear I ring gear

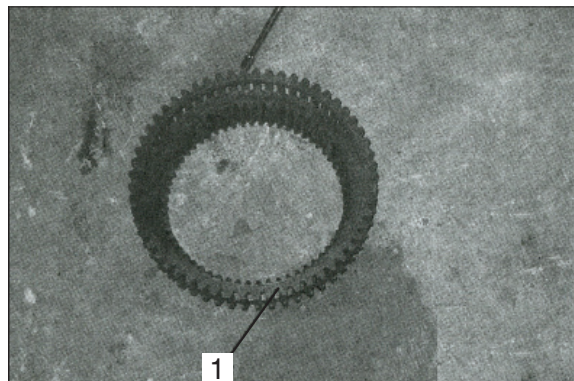

850KTM35

- 2 Driven disc
- 3 Driving disc

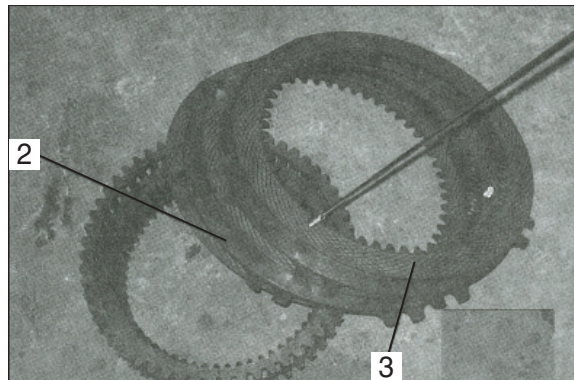

850KTM36

(7) Insert 15 springs and spring pins, and put the gear I cylinder body assy.

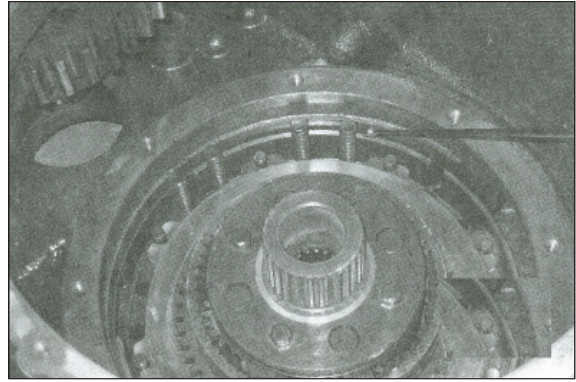

850KTM37

1 Gear I cylinder body

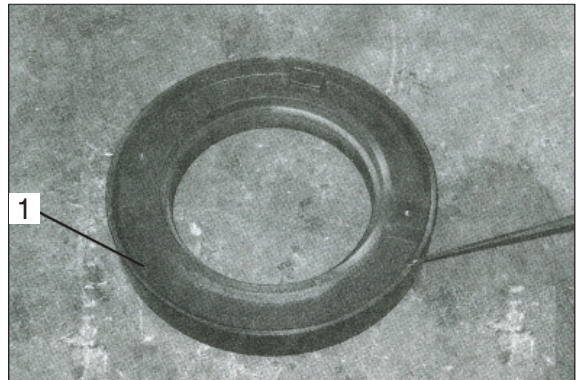

850KTM38

(8) Put the mid-cover and use a M22 socket wrench to fasten up 8-M14M0 bolts on the mid-cover.

1 Mid-cover

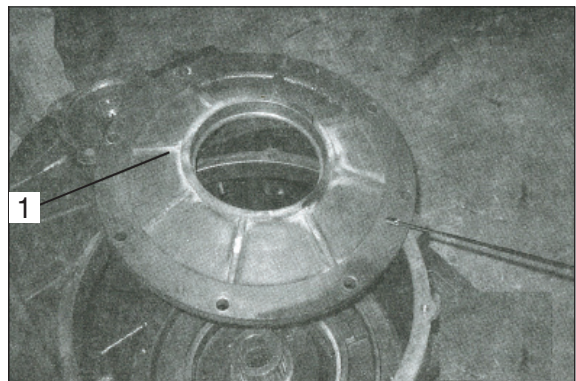

850KTM39



850KTM40

(9) Assemble direct gear assy, end cover, and use a M16 wrench to fasten up 8-M 10×30 bolts.

1 Direct gear assy

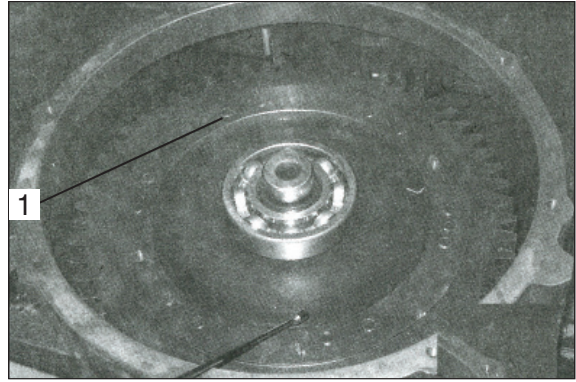

850KTM41

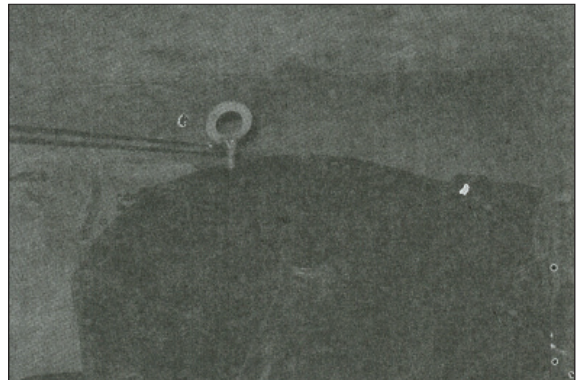

850KTM42

(10) Assemble steering oil pump driving shaft and gear shaft assy into the torque converter.

1 Gear shaft

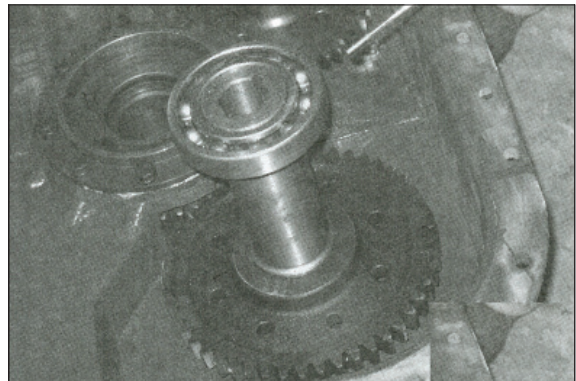

850KTM43

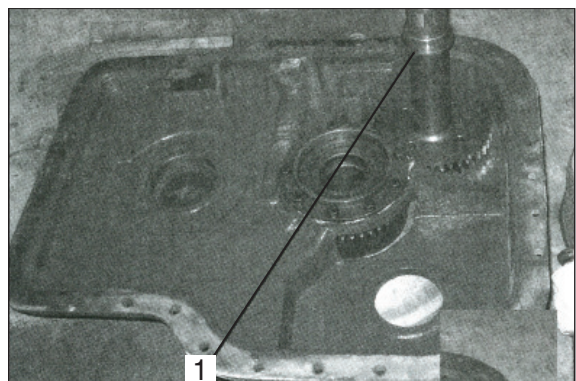

850KTM44

(11) Assemble the 1st/2nd stage gear input and bearings into torque converter.

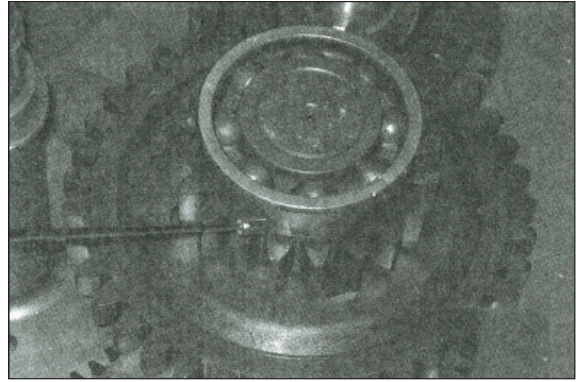

850KTM45



850KTM46

(12) Assemble the biaxial assy into the transmission box.

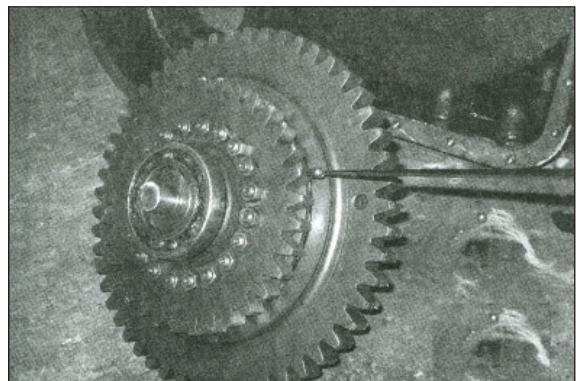

850KTM47

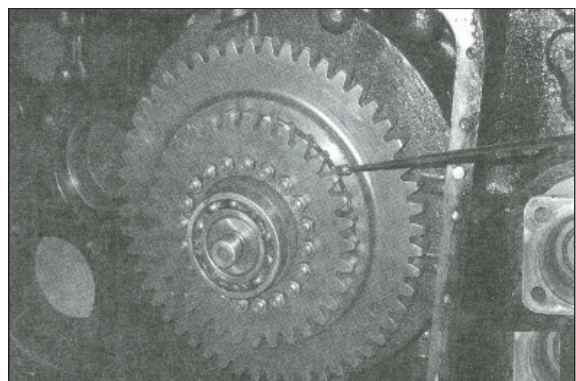

850KTM48

(13) Joint the torque converter to the transmission and set 2-A10×30 pin and then use a M16 socket wrench to fasten 26-M10×30 and 5-M10×70 to combine the torque converter with transmission box.

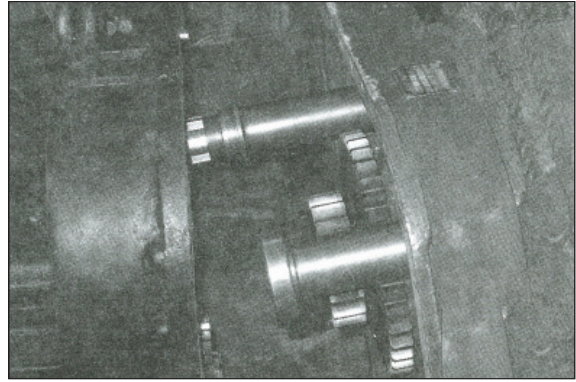

850KTM49

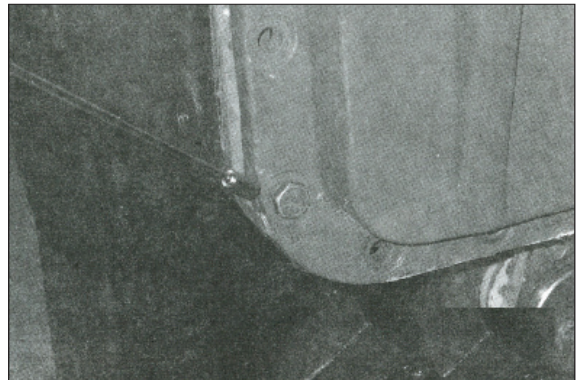

850KTM50

(14) Assemble the control valve and oil pump.

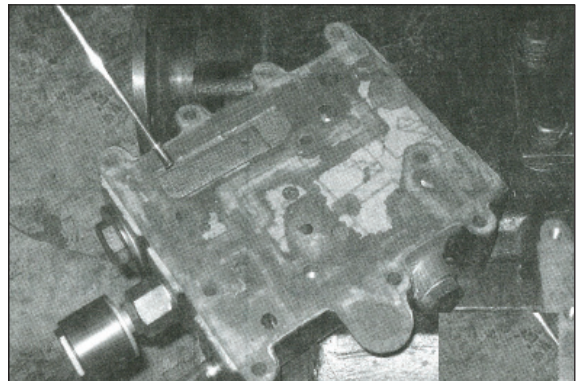

850KTM51

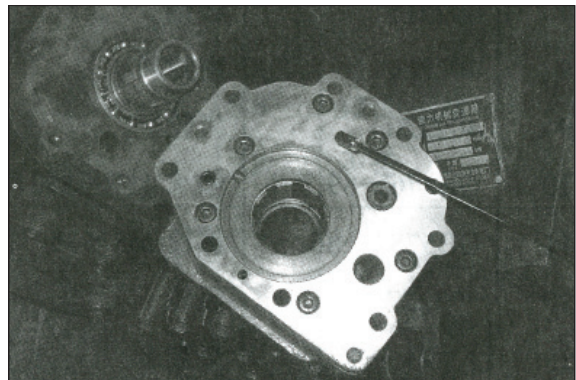

850KTM52