

GROUP 3 AXLE

1. OVERVIEW

1) FEATURES IN STRUCTURE

As the main part of chassis transmission system, driving axle has the functions of increasing the torque from engine, distributing it to the left and right side driving wheels, and allowing the wheels to have differential feature. In addition, driving axle also receives various forces from road and chassis.

The axle is a two stage transmission device and consists mainly of driving axle housing assembly, main reductor assembly, planetary reductor assembly and brake assembly. The first stage device is main reductor assembly driven by gleason bevel gear, which is large in input torque, high in efficiency, and stable in work.

The second stage device is planetary reductor assembly with planetary reduction driving structure with four planetary wheels (NGW type) which is high in overall running rigidity and stable in output speed.

2) PRINCIPLE

The inputting flange inputs the torque from engine, through the main reductor, the power will reach planetary reductor system via differential axle. Then the power is driven to planetary carrier, it makes the tire to move.

The work line is: engine torque→input flange→the main reductor→differential axle→planetary reductor system→Tire. (figure 1, 2)

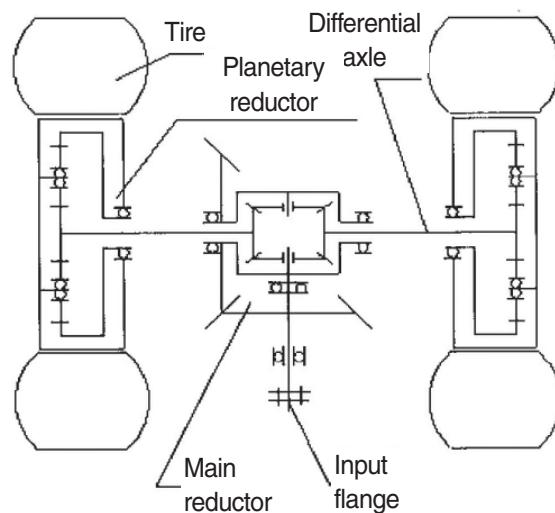

Figure 1

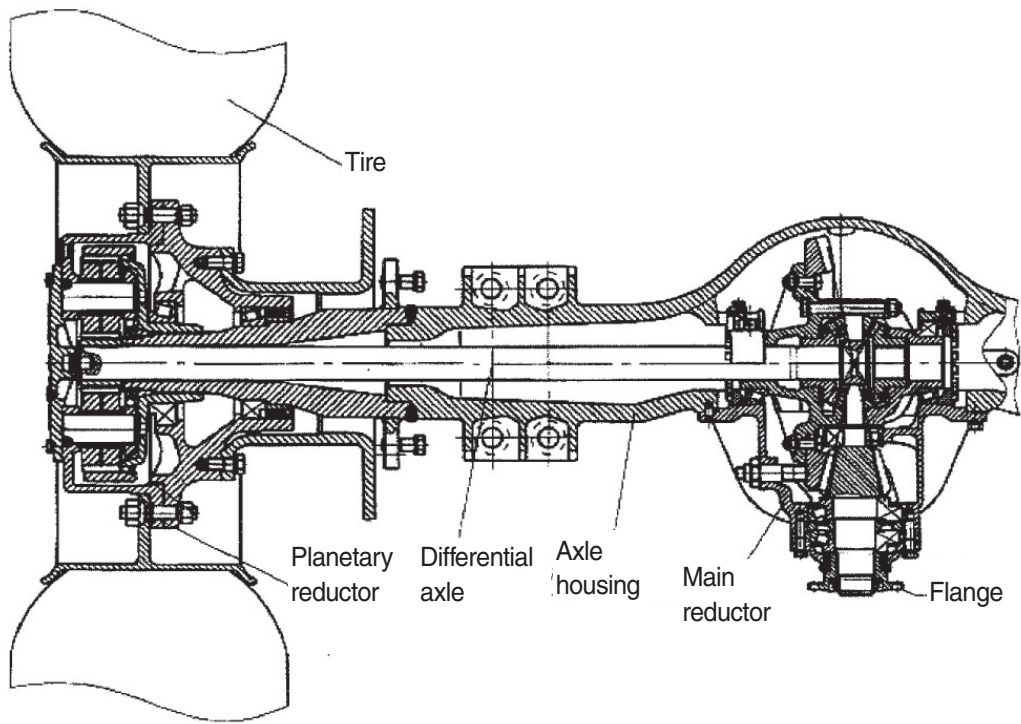

Figure 2

3) MAIN PERFORMANCE PARAMETERS

Model		ZL50K (front and rear axle)
Max. Load		27000 kg
Assembling dimensions		2248 mm
Fixing dimensions with chassis (mm)		890 × 260 × 400
Speed Ratio	Resultant gear ratio	26.11
	Main speed ratio	5.286
	Speed ratio of planetary reductor	4.9
Max. torque		520 kgf · m (3760 lbf · ft)
Brake torque		1330 kgf · m (9625 lbf · ft)
Oil pressure of braking		11 MPa

4) TROUBLESHOOTING

Names of the parts	Problem	Cause	Remedy
The main reductor and the differential gear	Large noise	The gaps of the gears are oversized. The rolling bearing is abraded.	Adjust the gaps of the gears. Exchange the bearing.
	Early-stage heat of the housing	The lubrication is bad, no lubrication oil or excessive lubricating oil.	Refuel to the normal oil level.
	Periodical abnormal noise	The gears are cut. There are foreign bodies inside. The stening piece becomes loose.	Exchange the gears. Drain the oil to inspect. Fasten the fastening piece.
	Malfunction of the differential gear	The cross axle is broken.	Exchange the cross axle.
	Oil leakage	The oil seal is aged and abraded. The sealing glue becomes ineffective. The fastening piece becomes loose.	Exchange the oil seal. Scrap the used glue, and smear afresh. Fasten the fastening piece.
The wheel reductor	Non-rotation of the wheel	The semi-axle is twisted off. The differenrial system doesn't work.	Exchange the semi-axel. Adjust and exchange the differential system.
	Abnormal noises	The gears are cut. There are foreign bodies.	Exchange the gears. Drain the oil to inspect.
	Early-stage heat of the housing	The lubrication is bad, i.e, no lubricating oil or excessive lubricating oil.	Refuel the lubricating oil to the oil level.
	Non-returning of the friction plate	The sealing ring of the piston is aged and abraded. The oil inlet nozzle beomes loose. The casting of the grip is defective.	Exchange the sealing ring. Screw the oil inlet nozzle. Exchange or repair the breaking grip.

5) STRUCTURE

(1) Front and rear axle

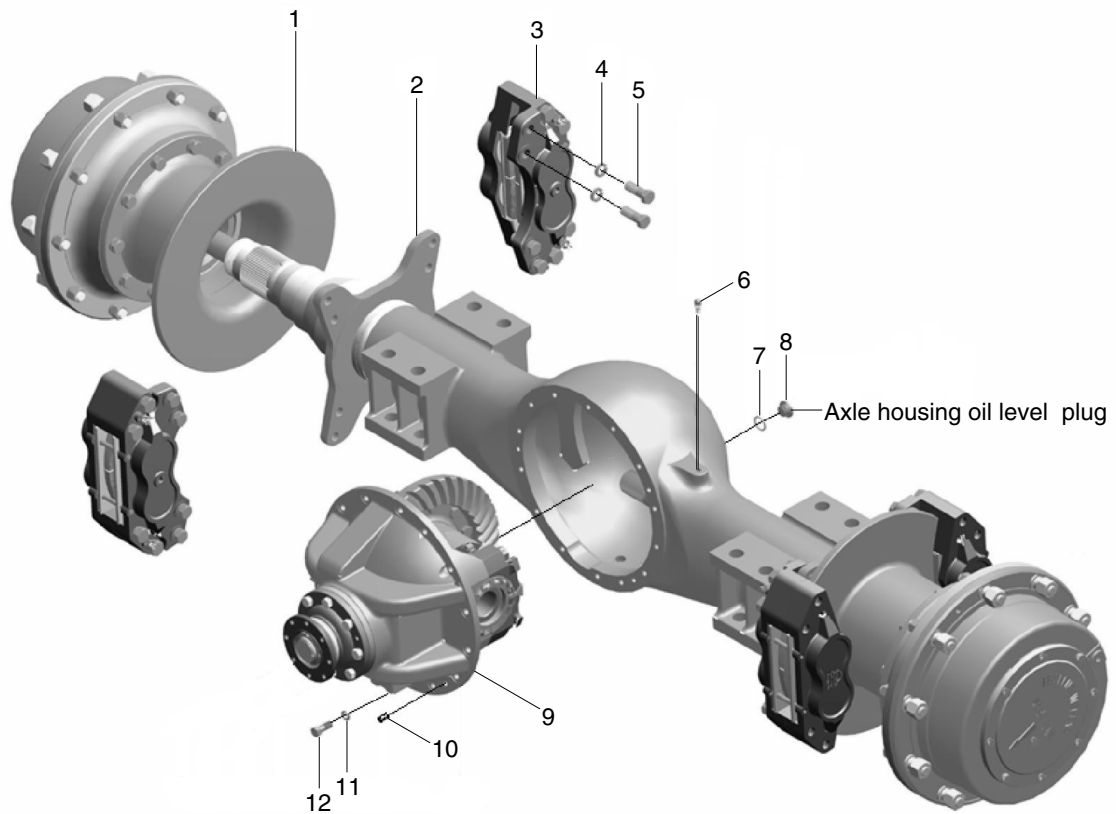

850KAX110

- 1 Planetary reduction assy
- 2 Driving axle shell
- 3 Brake assy
- 4 Washer
- 5 Bolt
- 6 Deflation valve

- 7 Seal
- 8 Plug
- 9 Main reductor
- 10 Pin
- 11 Washer
- 12 Bolt

(2) Planetary reductor

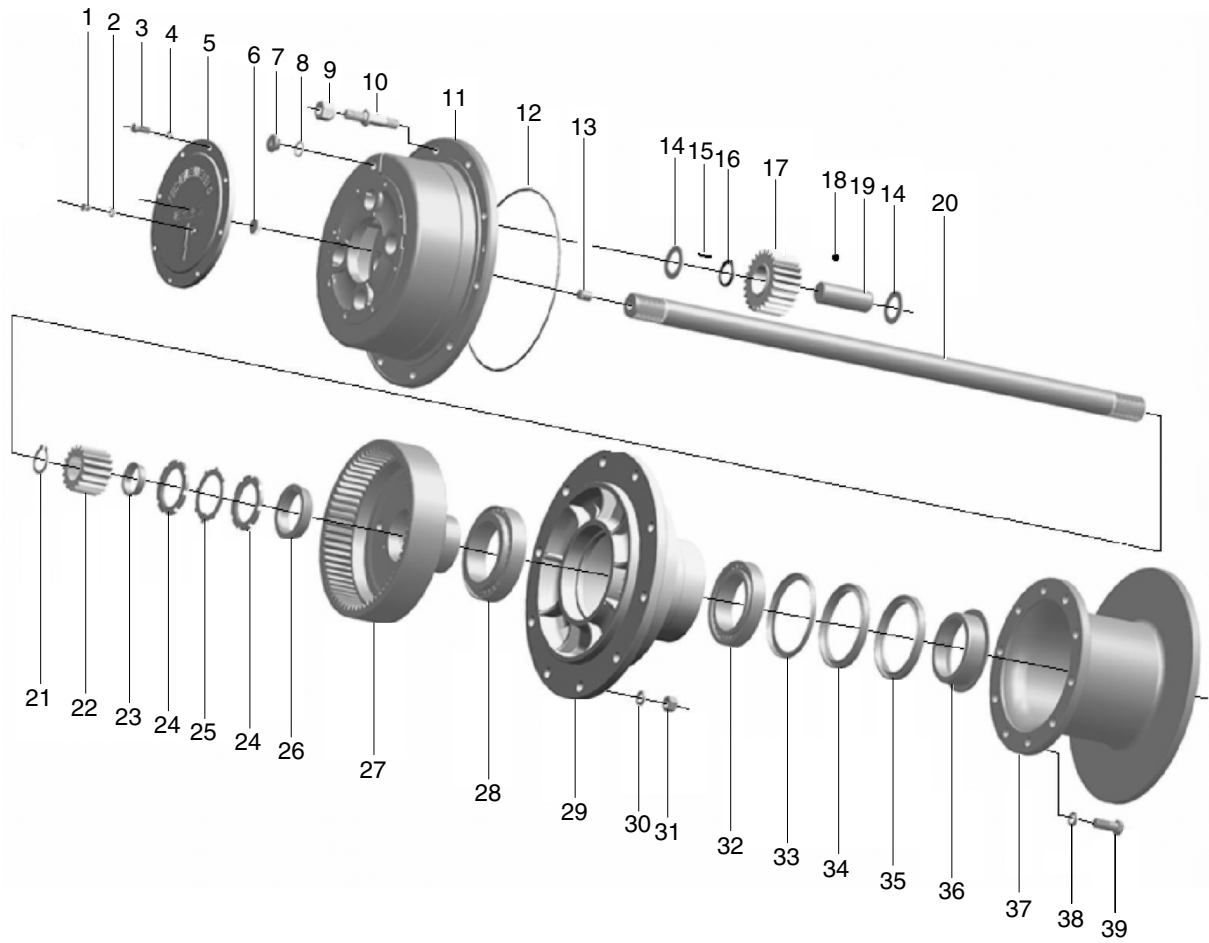

850KAX111

- | | | | | | |
|----|------------------------|----|----------------------|----|--------------------|
| 1 | Plug | 14 | Washer | 27 | Internal gear assy |
| 2 | Washer | 15 | Roller needle | 28 | Bearing |
| 3 | Bolt | 16 | Space bushing | 29 | Rim |
| 4 | Washer | 17 | Planetary gear | 30 | Washer |
| 5 | Cover | 18 | Steel ball | 31 | Nut |
| 6 | Snap ring | 19 | Planetary gear shaft | 32 | Bearing |
| 7 | Plug | 20 | Shaft | 33 | Seal spacer |
| 8 | Seal | 21 | Snap ring | 34 | Oil seal |
| 9 | Bolt | 22 | Sun gear | 35 | Oil seal |
| 10 | Bolt | 23 | Spacer | 36 | Gasket |
| 11 | Planetary gear carrier | 24 | Nut | 37 | Brake disk |
| 12 | Seal ring | 25 | Washer | 38 | Washer |
| 13 | Adjusting pin | 26 | Taper bushing | 39 | Bolt |

(3) Main reductor

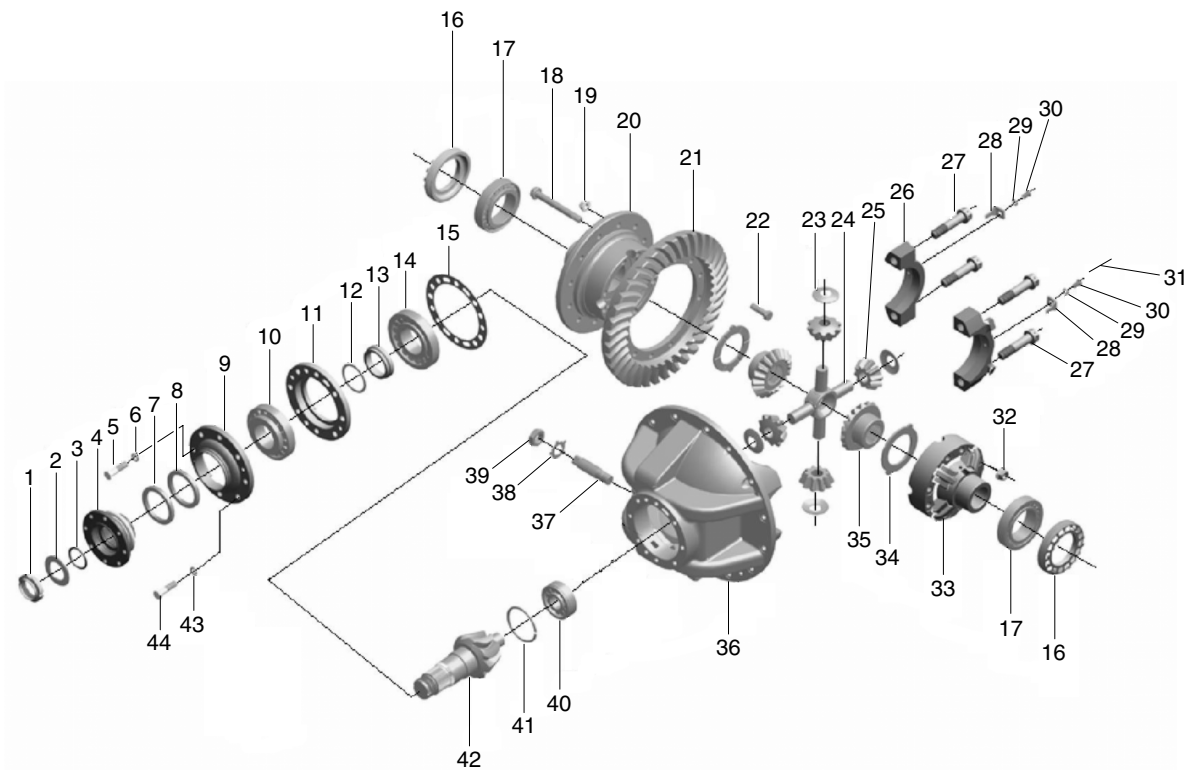

850KAX112

- | | | | | | |
|----|------------------|----|-------------------|----|-----------------|
| 1 | Lock nut | 16 | Adjusting nut | 31 | Iron wire |
| 2 | Washer | 17 | Bearing | 32 | Nut |
| 3 | O-ring | 18 | Differential bolt | 33 | Cage |
| 4 | Flange | 19 | Nut | 34 | Thrust washer |
| 5 | Bolt | 20 | Cage | 35 | Axle shaft gear |
| 6 | Washer | 21 | Driven bevel gear | 36 | Cage |
| 7 | Oil seal | 22 | Bolt | 37 | Bolt |
| 8 | Oil seal | 23 | Washer | 38 | Lock plate |
| 9 | Sealing gland | 24 | Crossing | 39 | Nut |
| 10 | Bearing | 25 | Bevel gear | 40 | Bearing |
| 11 | Bearing bushing | 26 | Bearing seat | 41 | Stop ring |
| 12 | Adjusting washer | 27 | Bolt | 42 | Bevel gear |
| 13 | Shaft bushing | 28 | Lock plate | 43 | Washer |
| 14 | Bearing | 29 | Washer | 44 | Bolt |
| 15 | Adjusting washer | 30 | Bolt | | |

(4) Brake assembly

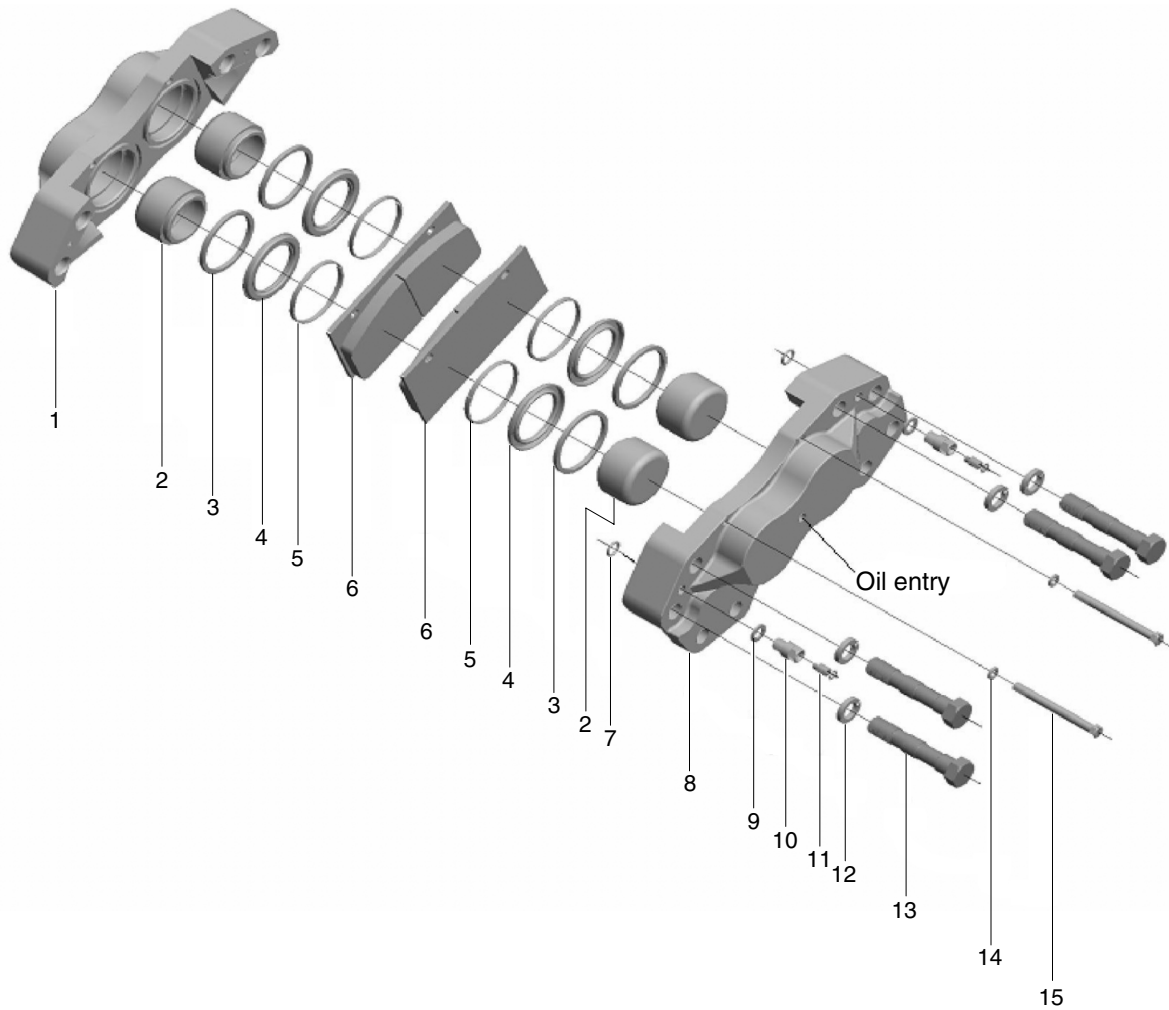

850KAX113

- | | | | | | |
|---|------------------|----|-------------|----|-----------------|
| 1 | Exterior brake | 6 | Brake disk | 11 | Deflating valve |
| 2 | Piston | 7 | O-ring | 12 | Washer |
| 3 | Rectangular seal | 8 | Inner brake | 13 | Bolt |
| 4 | Dust case | 9 | Washer | 14 | Washer |
| 5 | Block ring | 10 | Connecting | 15 | Bolt pin |

2. SPECIAL TOOL

The special tool is used to unfasten the main reductor lock nut.

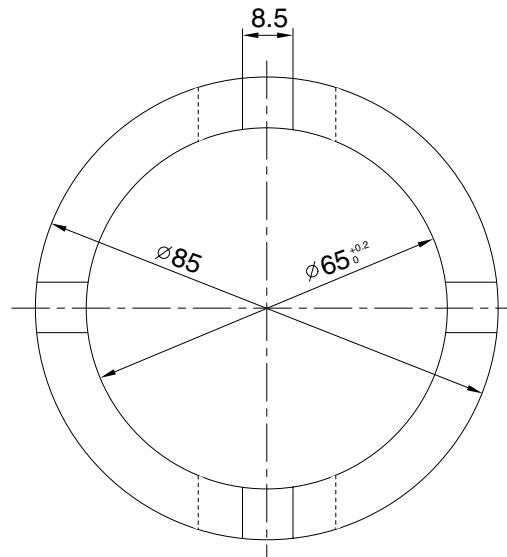
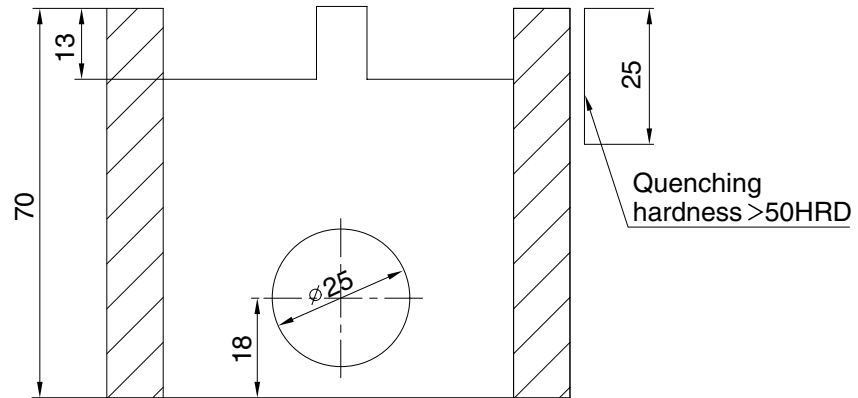

Unit : mm

850KAX104

3. DISASSEMBLY

1) Put the driving axle to disassemble on a secure support. Have a wide working area with good light, the ground being clean and free from dust, and preventing from wind that may carry dust.

※ Clean all surfaces of driving axle before disassembly.

2) Remove the oil plugs at axle bottom and two wheel sides to drain gear oil from axle housing.

※ Use a clean container for containing gear oil. Clean container allows easy estimation of used oil. Worn off metal, distinct deterioration or pollution of oil in the used oil shows the condition of axle.



850KAX08

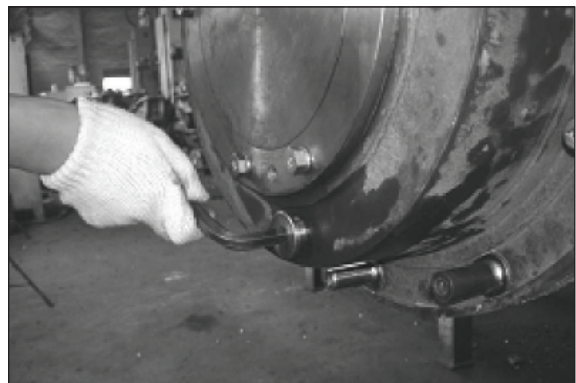

850KAX09

3) Removing brake caliper assembly. Use a torque spanner to unscrew M20 bolts (4 bolts for each brake caliper) and remove the brake caliper.

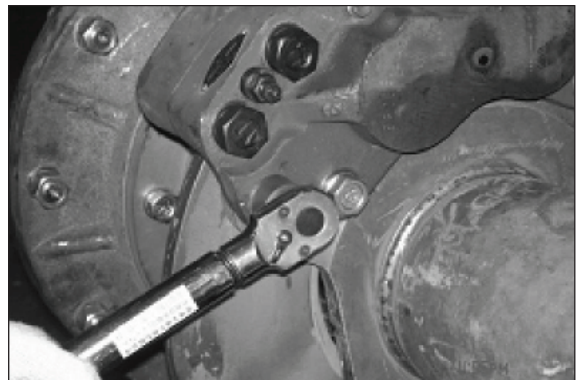

850KAX10

- 4) Removing each end cover at both sides of axle. Use a torque spanner to unscrew M12×1.25 bolt (8 bolts each side) and then push off the end cover with bolt through screw hole and remove it.

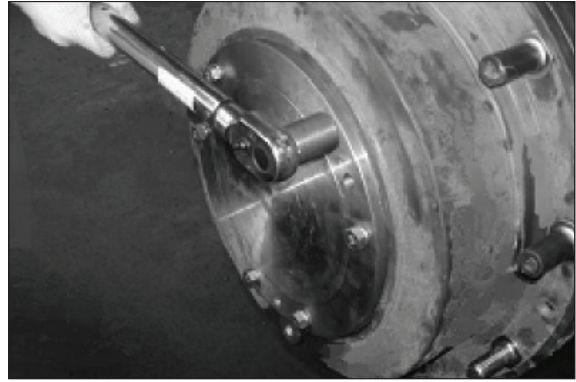

850KAX11

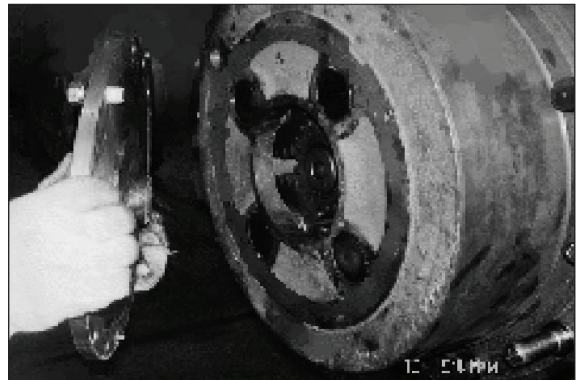

850KAX12

- 5) Pulling out the sun gear and differential axle. Remove the adjusting pin from the exterior end of differential axis and use a spring outside caliper to remove retainer ring at the same time and then remove the sun gear.



850KAX13

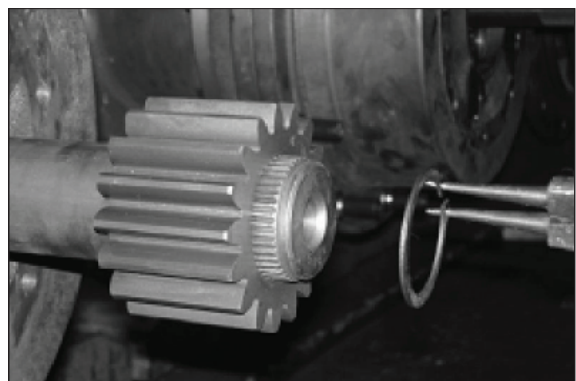

850KAX14

- 6) Removing main reductor assembly. Use a spanner to unscrew M16 bolts (total 14 pcs) and push the assembly off the axle housing with the bolt through screw hole, then move out with a hoisting equipment or manpower.
- ※ Step 5) must be performed before removing main reductor assembly. I.e, the differential axle must be pulled out in advance, otherwise it will catch axle shaft gear to cause removal of main reductor unavailable.

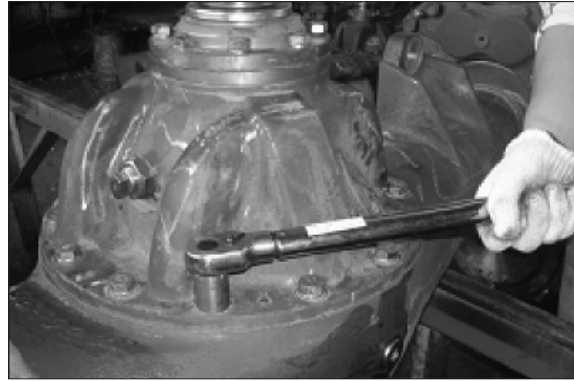

850KAX15



850KAX16

7) DISASSEMBLY AND INSPECTION OF MAIN REDUCTOR

- (1) Fix the assembly on a rotary table.
- (2) First remove the thrust bolt.

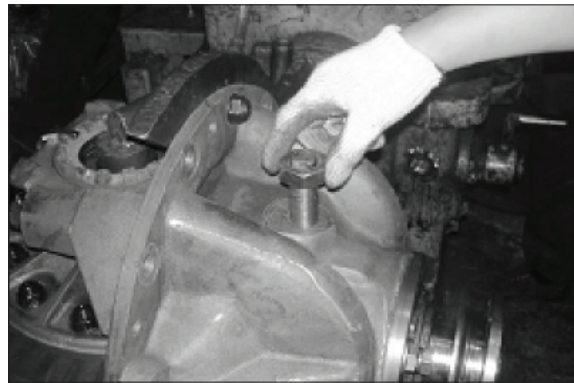

850KAX17

- (3) Make the assembly's larger side upward, and remove wire, M12 bolts and lock washers on the block.

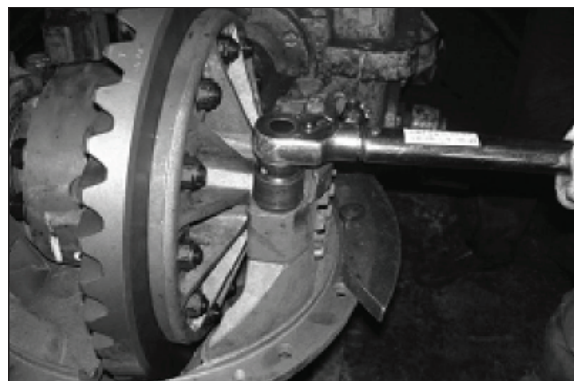

850KAX18

(4) Remove bearing block and adjustment nut.

※ Be mindful to make marking for the bearing block, adjustment nut and case for each side not to be confused when reassembling.

(5) Remove the differential assembly.

※ Be careful not to be confused with bearing outer race of two sides.

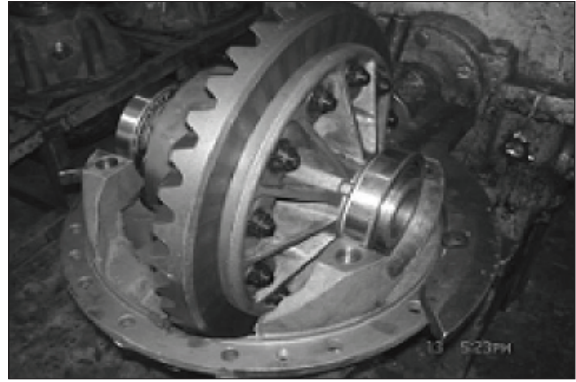

850KAX19

(6) Removing conical bearing. Unscrew driven crown gear bolts and nuts, total 12 sets, then remove the crown gear (driven) off the differential case.

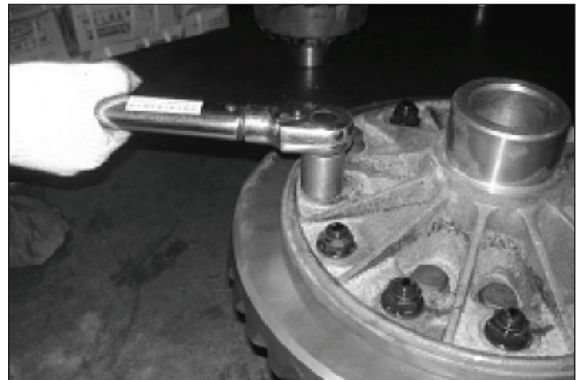

850KAX20

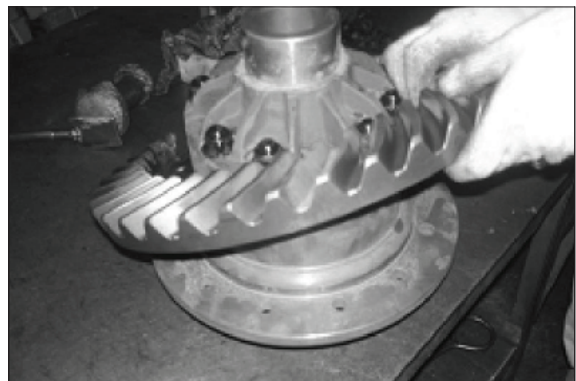

850KAX21

- (7) Turn the assembly over. First use a chisel or a sharp object to strip the locking portion of lock nut and then use a specialized tool to remove the lock nut. For specialized tool, refer to page 2-18.

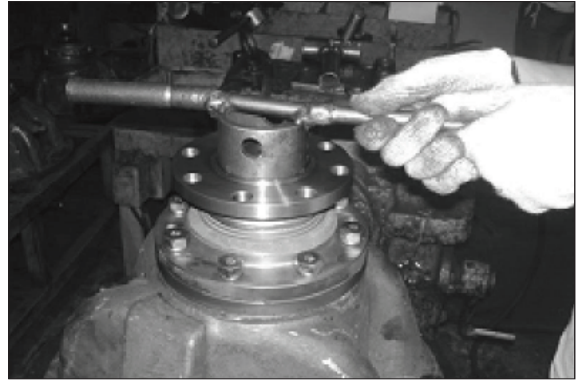

850KAX22

- (8) Remove the washer and O-ring and remove the flange.

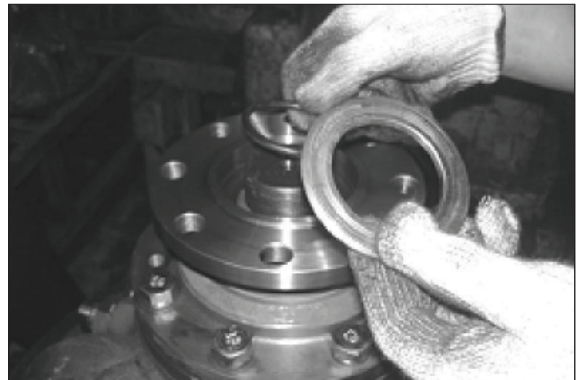

850KAX23

- (9) Remove the bolt on sealing gland and then remove the sealing gland.
※ When removing sealing gland, be careful not to scratch oil seal.

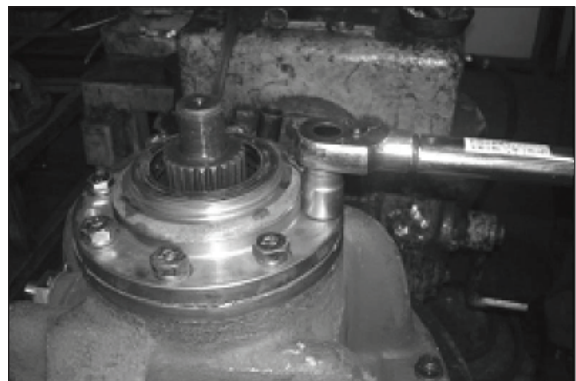

850KAX24



850KAX25

(10) Reassemble the flange and lock nut and use a bolt to push whole the driving gear off through the thread hole.

※ When removing a bearing block, be careful not to make the adjusting washer damaged or missing.

(11) Unfasten the lock nut and remove the flange, bearing bushing, shaft bushing and washer and so on in order.

※ When removing a bearing bushing, be careful to keep the shaft bushing and adjusting washer well.

※ Drive and driven gear form a pair and, when anyone is damaged, whole the pair should be replaced.

※ If three bearing inner rings to the drive gear are damaged or worn, a pulling tool can be used to pull out. Take care not to make bearing installing surface on the drive gear damaged.

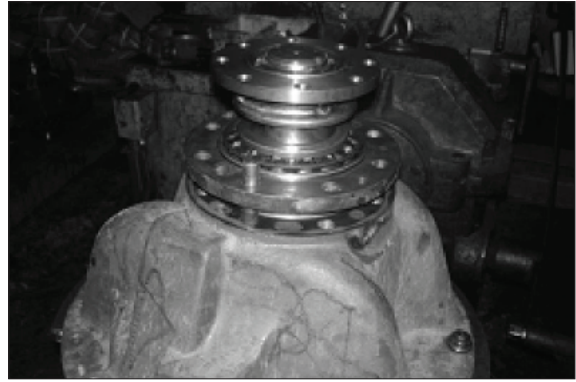

850KAX26

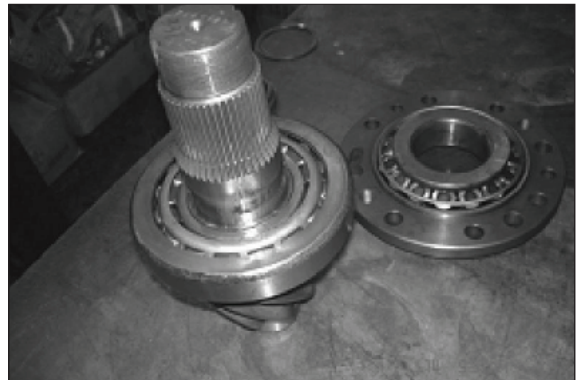

850KAX27

8) DISASSEMBLY AND INSPECTION OF DIFFERENTIAL DEVICE

(1) Remove the bolts, nuts (8 sets) of differential device and small differential cage.

※ When removing small cage of differential device, check if there is matching marks on the holes of differential crossing of large and small cage. If no, make marks.

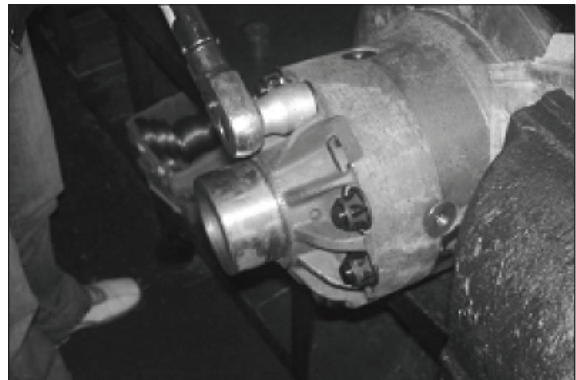

850KAX28

(2) Remove differential crossing, bevel gear and its washer, axle shaft gear and its washer.

※ If a bearing at two sides of differential device is damaged or worn severely, forcible removal is available (use a chisel to knock out).

Be careful not to have the bearing fitting surface on the differential cage damaged.

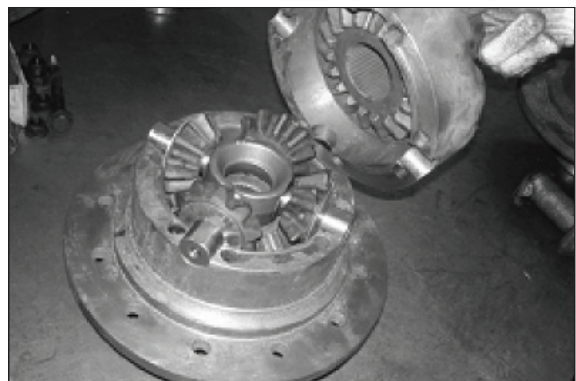

850KAX29

9) DISASSEMBLY AND INSPECTION OF PLANETARY REDUCTOR

- (1) Remove the bolts for rim.



850KAX30

- (2) Push the planetary carrier off with bolt through the thread hole (There are two thread holes on a planetary carrier) and O-ring on the hub.



850KAX31

- (3) Remove the inner hexagon nut and lock washer on final drive axle.



850KAX32

- (4) Remove the taper bushing (Use a copper bar to shock out).

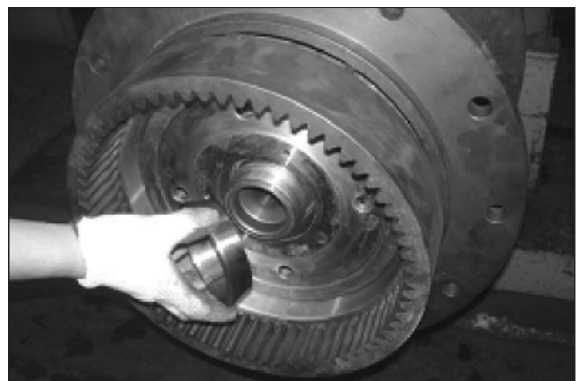

850KAX33

(5) Pull the ring gear carrier out.

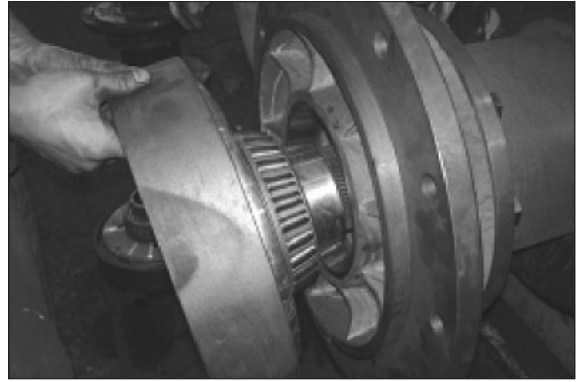

850KAX34

(6) Pull the hub and brake disc out (can be removed as one body).

※ When pulling the hub and brake disc out, be careful to keep balance as being hung in the air not to make the spline on the shaft to scratch oil seal.

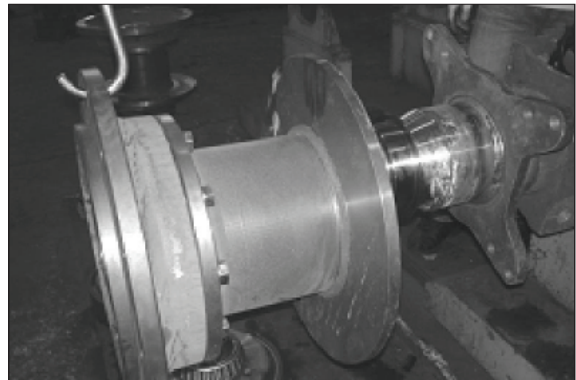

850KAX35

(7) Remove the bolts from brake disc to separate the brake disc from hub.

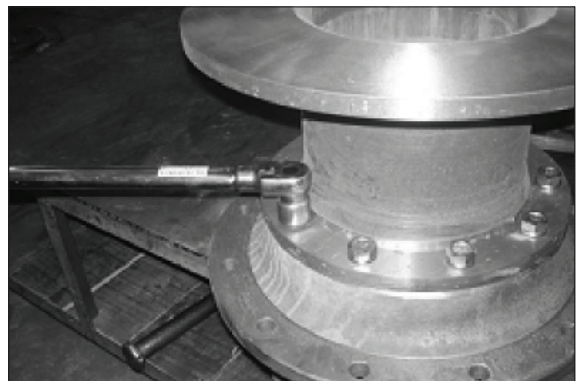

850KAX36



850KAX37

10) DISASSEMBLY AND INSPECTION OF PLANETARY CARRIER

- (1) Place the planetary carrier on a platform, with its large side upward. Use a pressing machine or manpower to press the planetary carrier out.
 - ※ Take out the locking ball at the other side as the planetary shaft is pushed out for about 15mm or it might be lost.



850KAX38

- (2) After removing four shafts, remove the planetary gear and washer.
 - ※ Be careful not make the needle, ring or washer of planetary gear to fall down or be lost.

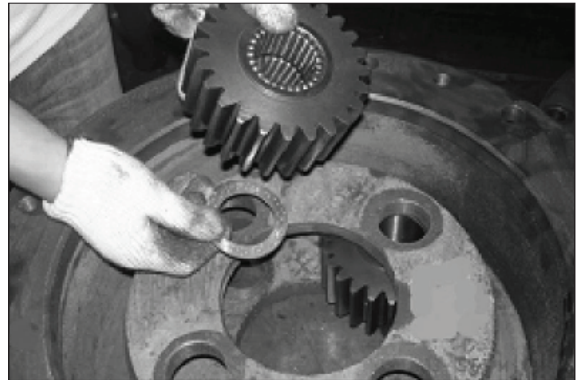

850KAX39

4. CLEANING AND INSPECTION

- 1) Examine each element and fine surface and determine if there is over wear.
- 2) Before reassembly, each part should be cleaned with kerosene and blown dry.
- 3) Specially for the positions where there was a damaged part, such as the inside of axle housing, main reductor or planetary carrier housing, the residue (iron and copper chippings) must be removed.
- 4) All the oil sealing elements should be replaced and reuse is not permitted once removed.

5. REASSEMBLY

1) Reassembly of the driving axle should be made in the reverse procedure of above disassembly.

(1) Place the cleaned large and small differential cages on a platform, set the axle shaft gear washer in the large differential cage, then fit the axle shaft gear. Set the planetary bevel gear and washer with ball face on to the four journals of differential crossing, which is then inserted into four corresponding holes in the large differential cage. Assemble another axle shaft gear, washer and small differential cage.

※ When assembling small differential cage, be careful to align the holes of differential crossing of large and small differential cage with the markings.

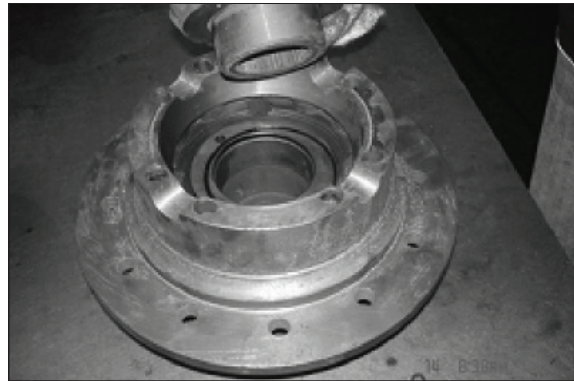

850KAX40

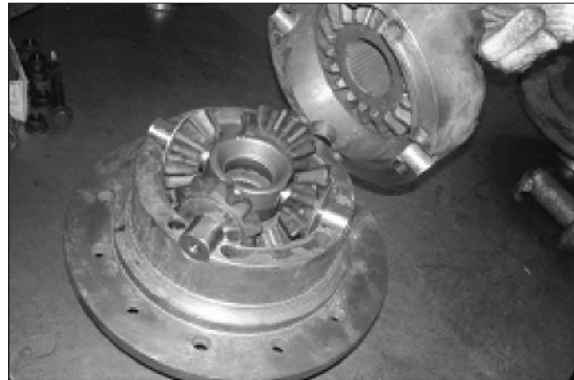

850KAX41

(2) After assembly of differential device, use the bolts applied thread locking glue to joint, and fasten up with M16×1.5 nuts. Tightening torque should be 19.7~26.2 kgf · m (142~190 lbf · ft).

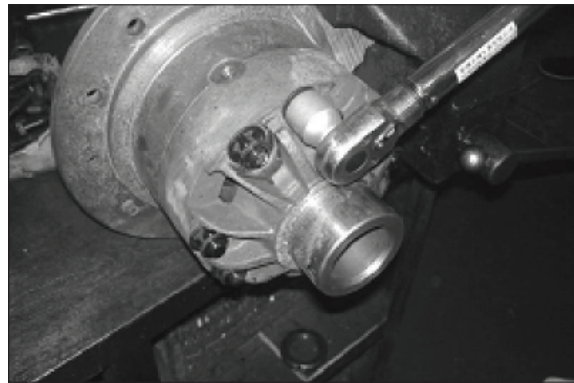

850KAX42

(3) Assemble the driven spiral bevel gear onto the flange of large differential cage, use the bolts applied thread locking glue to joint, and fasten up with M16×1.5 nuts. Tightening torque should be 19.7~26.2 kgf · m (142~190 lbf · ft).

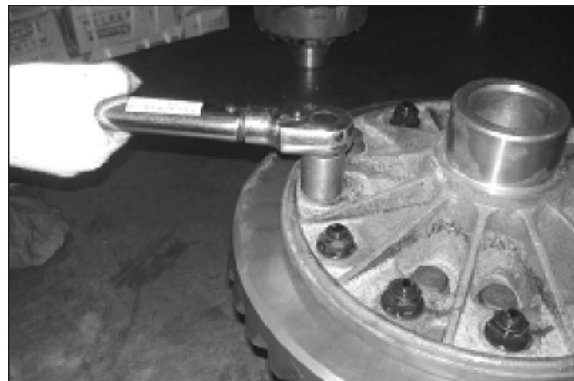

850KAX43

- (4) Use a specialized tool to push the preheated bearing inner race into two sides of differential device.

The gear backlash of axle shaft gear and bevel gear is 0.18-0.23 mm and, after assembly, the gears should facily rotate and has no deactivation.

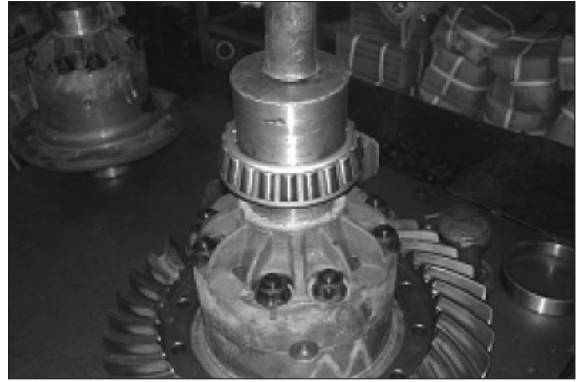

850KAX44

2) REASSEMBLY OF DRIVE GEAR ASSEMBLY

- (1) Push the bearing inner race onto the journal of drive spiral bevel gear and then fit the outer race. Then, fit the shaft bushing and adjusting washer, assemble the bearing bushing fitted with bearing, bearing inner race, flange and main reductor lock nut.

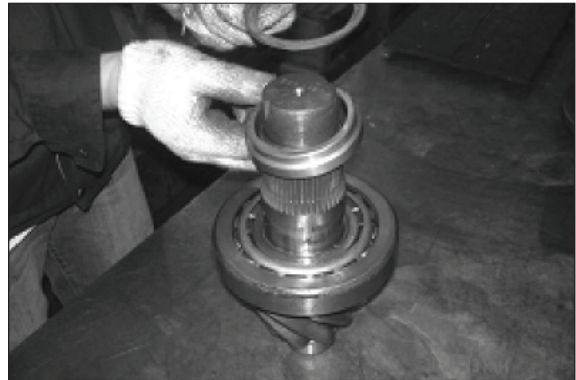

850KAX45

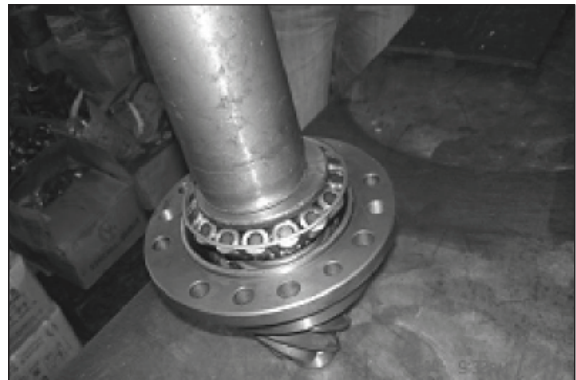

850KAX46

- ※ The lock nut should be only fastened up, not locked with thread locking glue. Apply a force of 35~40 kgf · m (253~289 lbf · ft) to the lock nut for main reductor and then use a tension gauge to hook in the fitting hole of bearing bushing and pull the gauge in tangential direction. The torque should be OK if the readings of the gauge is within 1.32~1.97 kgf · m (2.91~4.34 lbf · ft) as the bearing bushing starts to turn.

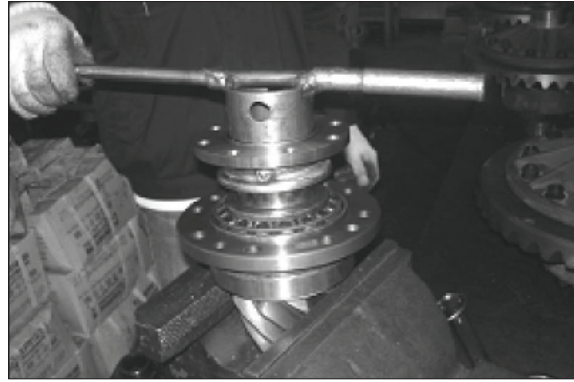

850KAX47

- (3) Take a bearing and push its inner race into drive spiral bevel gear journal and assemble a snap ring onto the outer ring.

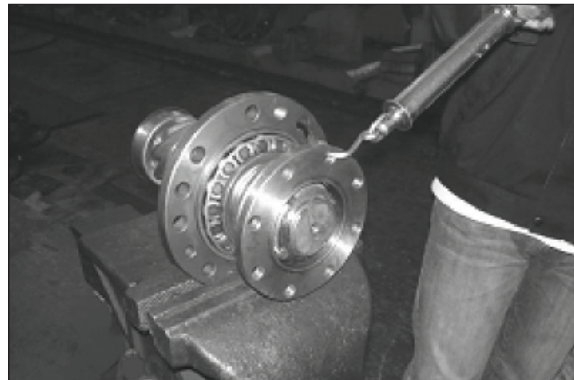

850KAX48

3) REASSEMBLY OF MAIN REDUCTOR

- (1) Fix the case of main reductor on a rotary table with its small side upward, apply sealant onto the adjusting washer and fit it onto the small side, then assemble drive gear assembly, and fasten up with two M14×1.5×55 bolts with a torque of 12.6~16.8 kgf · m (91.1~122 lbf · ft).

- ※ When assembling drive gear assembly, be careful to make the oil passage hole on bearing bushing aligning with that of casing.

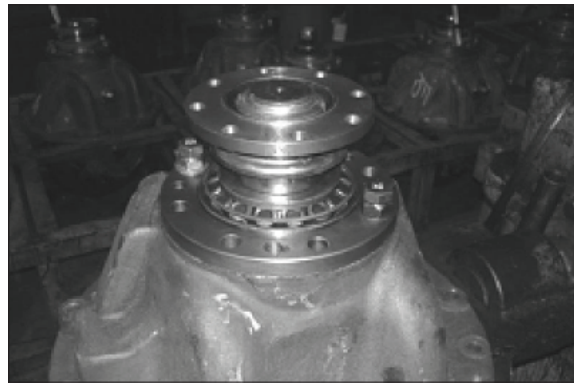

850KAX49

- (2) Turn the case for 180° to make large side upward and fit the differential assembly in.

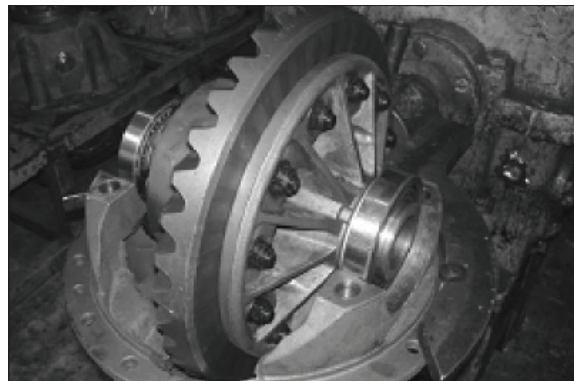

850KAX50

- (3) Fit the bearing block and adjustment nut. Assuring a certain backlash between drive and driven gears (apprx. 0.25-0.40), fasten the adjustment nut at a side to the extent that the driven gear can be turned with difficulty and then turn the nut back 1/5~1/10 turn to keep the axial clearance of bearing within 0.1~0.18, to secure a certain pre-tight strength between two tapered bearings.

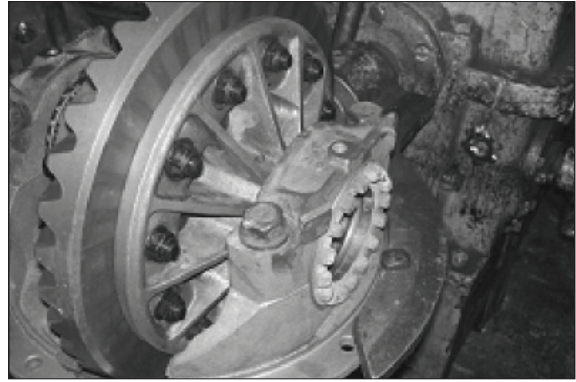

850KAX51

- (4) Precisely adjust the back lash between drive and driven spiral bevel gears to be within 0.25~0.40, its variable less than 0.1. Be sure that, when the nut at one side is turned back, the other side nut is fastened for the same extent, to secure the pre-tight strength as adjusted under above item (figure 850KAX52).



850KAX52

- (5) By marking test, the contact face should be near to the small side along tooth length, mesh mark $\geq 1/2$ of tooth length, and the contact face at the middle of gear surface. Mesh mark should meet the requirements of figure 850KAX55. Otherwise, the number of adjusting washer (shim) can be added or subtracted, or loosen the nut at one side and fasten that at other side for the equal amount to make adjustment (figure 850KAX55).

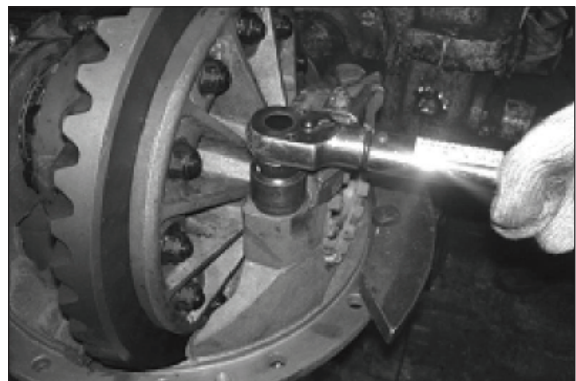

850KAX53

After completing this step of adjustment, be sure to inspect the back lash again as described in above step. If the requirements as correct mesh mark and back lash can not be met simultaneously, the pair of drive & driven spiral bevel gear or main reductor case must be replaced.

- (6) Fasten up the bolts for main reductor with torque of 75.5~89.7 kgf · m (546~649 lbf · ft), lock the locking washer with M10×20 bolts with torque of 4.6~6.0 kgf · m (33.3~43.4 lbf · ft) (figure 850KAX53).
- (7) Fasten up the bolts for main reducers, locking washer and bolt M10×20-8.8 and bind with wire (figure 850KAX54).

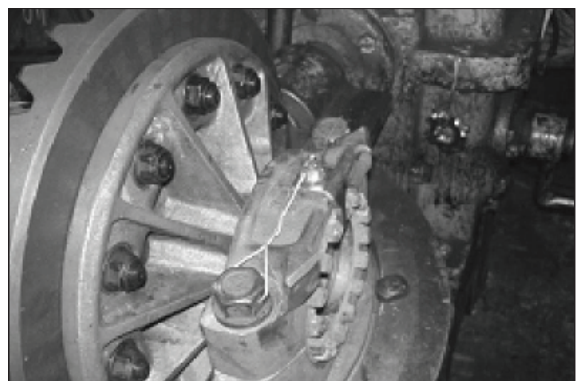

850KAX54

※ **BACKLASH CHECK AND ADJUSTMENT**















	Contact position on driven gear face		Method of adjustment	Gear moving direction
	Forward	Backward		
Driven spiral bevel gear  Drive face				
Driven face 				
Drive spiral bevel gear  Drive face			Move the driven gear away from drive gear. Move the drive gear inward if the back lash is too large.	
Driven face 				
Driven face 			Move the drive gear away from driven gear. Move the driven gear inward if the back lash is too large.	

Figure 850KAX55

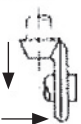
(8) Clean the bore of seal gland, and apply a certain amount of grease and push the oil seal B80×100×10, FB80×100×10 into seal gland in order. Then apply lithium bisulfide grease into the gaps of two oil seals.

※ For the order of two oil seals, FB type oil seal should be at outside and the seals be pressed level.

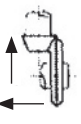

850KAX56

- (9) Place case with its small side upward, remove the flange and two M14 bolts, apply sealant on the end surface of bearing bushing, and fit up the seal gland with oil seal, apply thread lock glue to M12×1.5×55-10.9 and M14×1.5×55-10.9, then assemble along with grower washer, fasten diagonally.



850KAX57

Fastening torque for M12×1.5×55-10.9 should be 8.2~10.2 kgf · m (59.3~73.8 lbf · ft), that for M14×1.5×55-10.9 be 12.6~16.8 kgf · m (91.1~122 lbf · ft).

- ※ When fitting sealing gland, be careful not to make the spline to scratch oil seal.

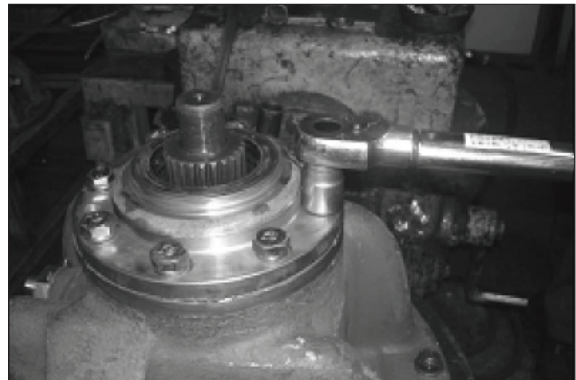

850KAX58

- (10) Install the flange on to the spline of drive spiral bevel gear, then fit the O-ring, washer and lock nut, with fastening torque to the lock nut at 76.5~81.6 kgf · m (553~590 lbf · ft) (lock up the lock nut after checking there is no error in assembly).

- ※ Check if the surface of flange to contact with oil seal is smooth and without cracks.

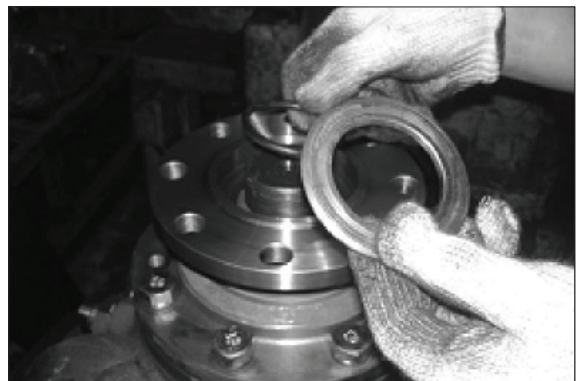

850KAX59

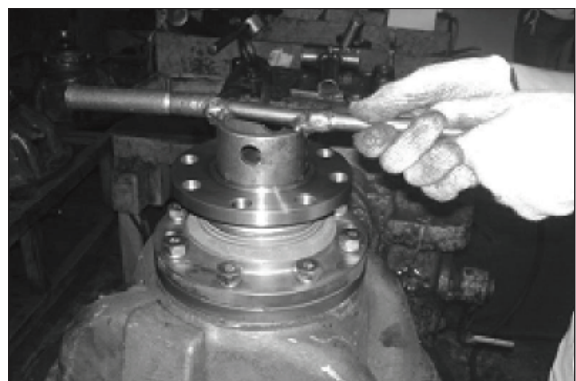

850KAX60

- (11) Turn the bracket for 90°, insert the thrust bolt applied sealant, turn it into position, and then turn back for 1/4 turn, and fit lock washer and M27×22 nut, turn with fastening torque at 45.9~54 kgf·m (332~391 lbf·ft) to lock up the lock washer.

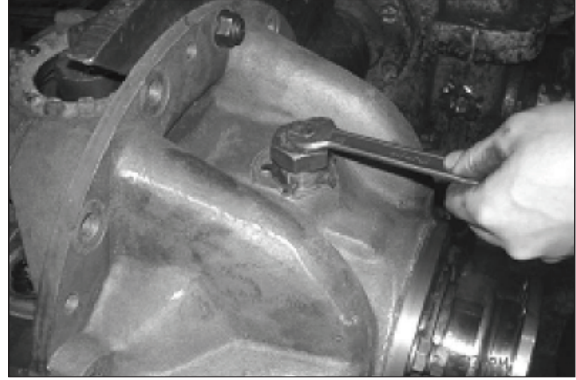

850KAX61

4) REASSEMBLY OF PLANETARY CARRIER ASSEMBLY

- (1) After cleaning the bore of planetary gear, apply a right amount of lithium grease, and insert the selected needles and space bushing of planetary gear into the bore. Be careful that needles selection should be matching, with the difference between max. and min. diameter less than 0.003 mm.



850KAX62

- (2) Fix planetary gear and washer.

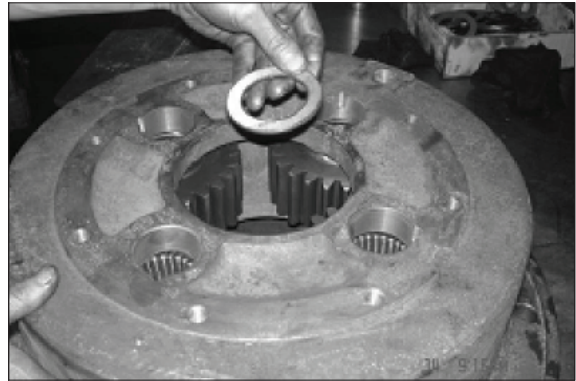

850KAX63

- (3) Push the planetary gear shaft into the planetary carrier, put a $\phi 3/8$ steel ball in the hemispherical hole to prevent the planetary gear shaft to turn.



850KAX64

5) REASSEMBLY OF HUB ASSEMBLY

- (1) Place the hub on a table with its small side upward, apply a right amount of grease on the inner surface of the bore of hub and then push a bearing outer ring into small side, put up the inner race, and push the oil seal spacing bush into the bore. Use a specialized tool to push oil seal B 150 × 180 × 15 and FB150 × 180 × 15 into the bore of hub in order.

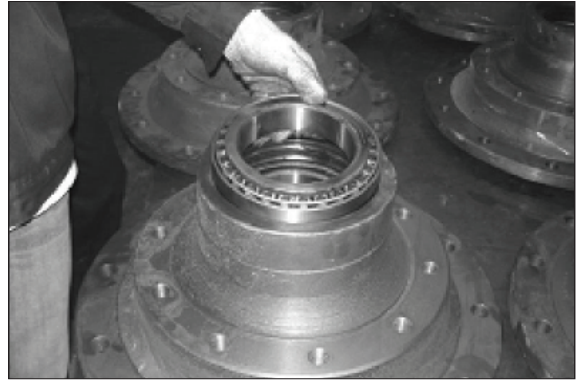

850KAX65

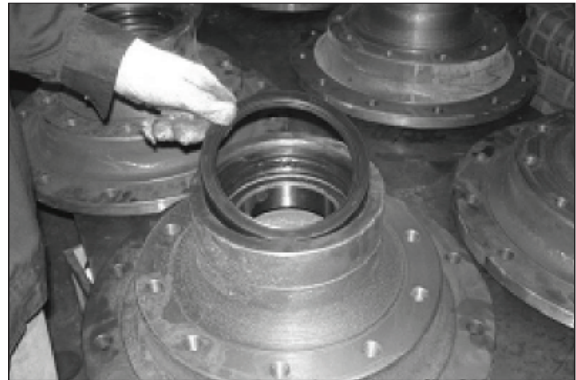

850KAX66

- (2) Assemble the brake disc and fasten with brake disc bolts M20 × 1.5 and grower washer with a torque at 51~60 kgf · m (369~434 lbf · ft).
- (3) Turn over the hub with brake disc assembled with its large side upward, apply a right amount of grease on the inner surface of the bore on the large side of hub, and push the outer ring of bearing 32026 in.
- (4) Fit the O-ring onto the rabbet of $\phi 384$ hub.

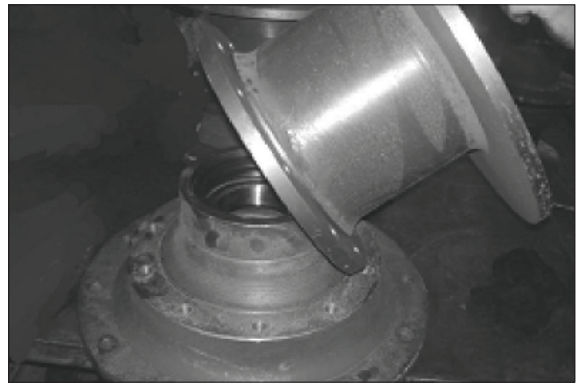

850KAX67



850KAX68

6) REASSEMBLY OF AXLE

- (1) Clean the axle housing assembly and put it on a support, insert the preheated gasket to wheel side supporting axle thermally securing the end surface of gasket to be perpendicular with axle center and the parallelism with support is controlled within 0.1 mm.
- (2) Mount the hub assembly at the both sides of axle.
 - ※ When assembling hub and brake disc, keep them in good balance and suspending to prevent the oil seal from being scratched by spline.
- (3) Preheat the inner race of bearing and fit it into the small side of ring carrier assembly welded and align the female spline of ring carrier with the spline of wheel side supporting axle to assemble.

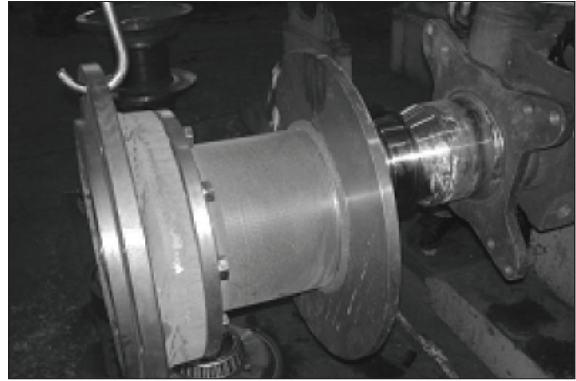

850KAX69

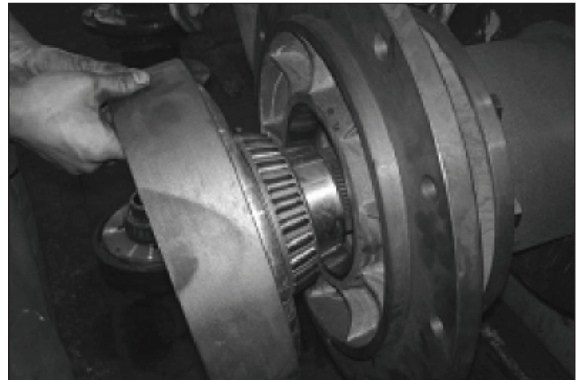

850KAX70

- (4) Fit taper bushing.

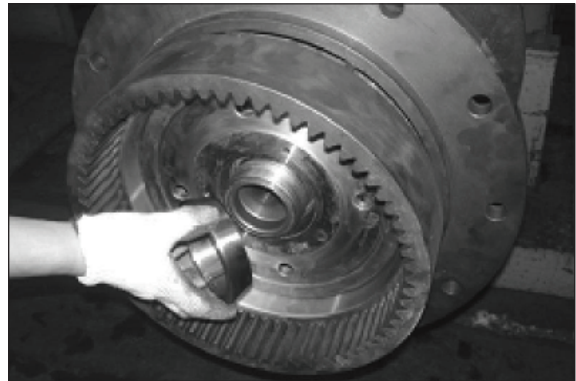

850KAX71

- (5) Turn the inner hexagon nut to the thread onto the wheel side supporting axle (apply thread lock glue on the thread of nut) and fasten to give a certain pre-tight strength to the bearing and turn the hub at the same time to make two bearings into correct positions. Apply a twisting force of $11.9\sim 16.1 \text{ kgf} \cdot \text{m}$ ($86.0\sim 116 \text{ lbf} \cdot \text{ft}$) to the rim bolts and at the time, just moving of hub means the pre-tight strength of taper bearing is OK. Put up a locked spacer and make its claw to get in the locking groove of nut and then fasten up the lock nut (inner hexagon nut, locking glue applied on the thread) at outside with a torque of $35.7\sim 40.8 \text{ kgf} \cdot \text{m}$ ($258\sim 295 \text{ lbf} \cdot \text{ft}$) making its locking claw to get in the locking groove of outside nut.

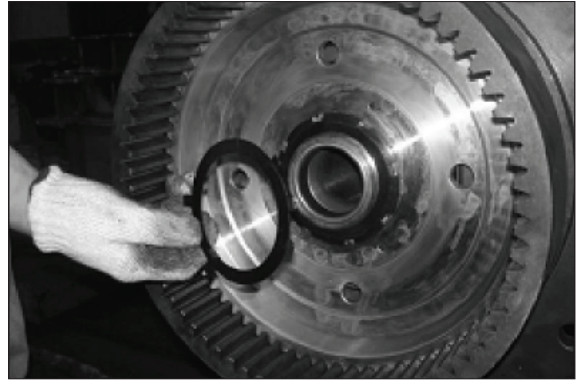

850KAX72

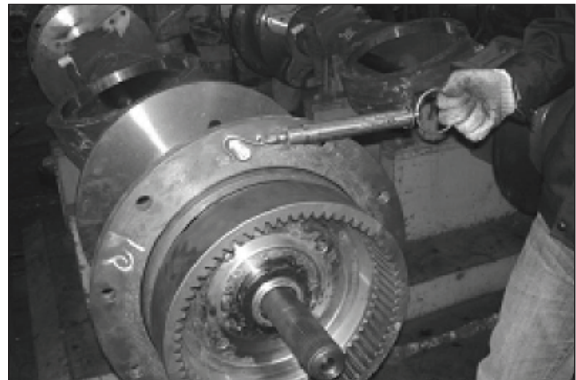

850KAX73

- (6) Assemble planetary carrier.



850KAX74

- (7) Assemble rim bolts and nuts, and fasten up with a torque spanner with a torque of $43.8\sim 47.9 \text{ kgf} \cdot \text{m}$ ($317\sim 346 \text{ lbf} \cdot \text{ft}$).
- ※ Take care to check if the O-ring is fit up for rim when fixing planetary carrier.



850KAX75

- 7) When mounting main reductor, first locate three stop dowels on the mounting surface of axle housing and apply a coat of silicone adhesive uniformly between the main reductor and axle housing and align the main reductor to its mounting position to assemble and fasten up with main reductor bolts M14×1.5×35 with a torque of 12.6~16.8 kgf·m (91.1~122 lbf·ft) (M16×1.5×35 and 19.7~26.2kgf·m (142~190 lbf·ft)).

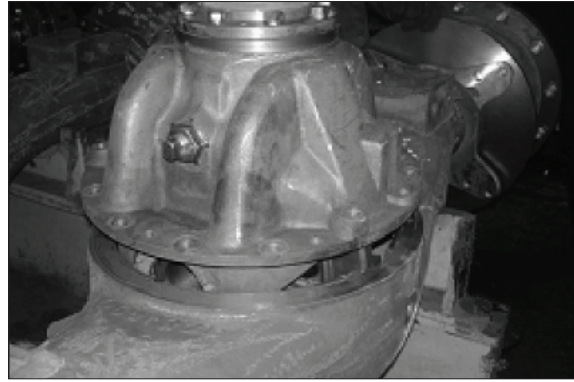

850KAX76

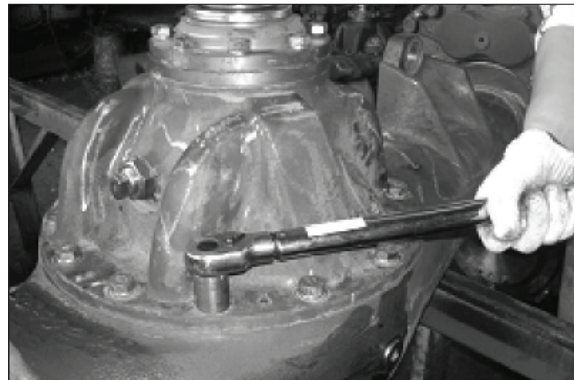

850KAX77

- 8) Set the sun gear at the side of differential axle with locating groove and set the snap ring and push into axle housing securing correct mesh between sun gear and the planetary gear inside the planetary carrier. After that two people can turn the wheel side at two different sides in reverse direction and smooth rotation should be secured.



850KAX78

- 9) Select suitable adjusting pin and end cover for the two sides of axle and secure a 1-2 mm clearing between the adjusting pin and stop block after assembly. Apply some silicone adhesive on the end cover and fix it on the planetary carrier with M12×1.25 bolts wrapped with tape and fasten up with a torque of 7.1~9.2 kgf·m (51.4~66.5 lbf·ft).

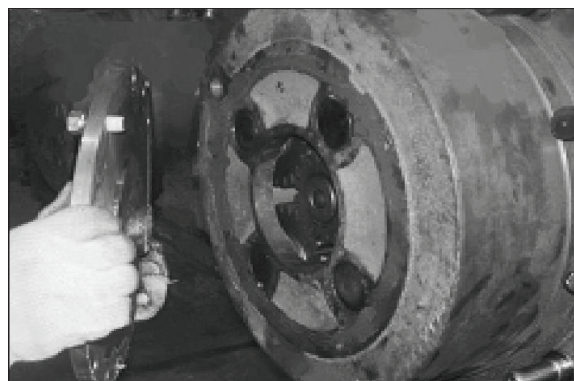

850KAX79

10) Mount the brake caliper and fasten up with brake caliper bolts with a torque of 51~59.1 kgf · m (369~427 lbf · ft).

11) Insert the plug at the axle bottom and fix. Supply oil into the axle housing (differential gear) and wheel side (planetary gear).

· Oil amount

Front axle : 24 l (6.3 U.S. gal)

Rear axle : 24 l (6.3 U.S. gal)

Supply oil unit is it overflows from the oil filler, then install the plug.

Recommended oil is SAE 85W-90.

6. GENERAL TROUBLES AND TROUBLESHOOTING

Since the loader features great torque and complex structure, failure to observe repair and working standards may cause troubles. Followings are description of troubles, causes, symptoms and measures.

1) ABNORMAL NOISE FROM DRIVING AXLE

Complex noise is produced from driving axle and defective parts, incorrect assembly and adjustment of main transmission system and excessive wear during using cause noise in travelling and operation. Generally, noise increases by increase of vehicle speed.

(1) Noise due to inappropriate backlash between drive and driven gears.

① Symptoms and causes.

- Too much backlash between two gears causes arrhythmic gear knocking sound, clunking.
- Too little backlash causes gears to jam and overheat.
- Uneven backlash causes rhythmic rattle noise and further causes the driving axle to sway.

② Measures.

- Remove the main reductor and adjust the back lash between drive and driven gears.

(2) Noise due to improper fit of incorrect bearing clearance

① Symptom and cause.

- Too little clearance causes noise sounds like continued "M---!" and excessive clearance like "Hara---Hara!"

② Measures.

- Remove main reductor and add or subtract washer/shim to readjust bearing clearance.
- Replace with new bearing, if damaged, and readjust the clearance.

(3) Periodic abnormal noise

① Symptom and cause.

- Gears are cut, or there are foreign objects inside sounding like clatter.

② Measures.

- Replace the damaged gear or clear the foreign objects.

(4) Abnormal noise in differential device

① Symptom and cause.

- When planetary gear and differential crossing are jammed, cracking sound is made, specially as cornering.
- Poor mesh gears make complex noise such as sounding "M---" as machine travel in straight line and plus clicking as cornering.

② Measures.

- Remove main reductor to replace differential crossing, or planetary gear and differential gear.

2) DRIVING AXLE HOUSING OVERHEAT

(1) Symptom and cause.

After a period of time of travelling or operation, touch the axle housing with hand and, when you feel hot and can not sustain, the axle housing is determined overheat. Overheat of axle housing is mainly due to too little bearing clearance, too little back lash of drive and driven gears, choked deflection valve on the axle, or insufficient lubricant.

(2) Measures.

First check the deflection valve for being choked, and insufficient lubricant and, if no problem with these factors, remove main reductor, and check and adjust bearing clearance or back lash between drive and driven gears.

3) OIL LEAKS

(1) Symptom and cause.

Gear oil leaks at junction between main reductor and axle housing, junction between main reductor flange and sealing gland, and inside planetary reductor. Oil leaks at junction between main reductor and axle housing is mainly due to loose bolt or deteriorated sealant and that at junction between main reductor flange and sealing gland and inside planetary reductor is mainly due to aged and worn oil seal or O-ring.

(2) Measures.

Reapply sealant and fasten up bolts, replace sealing gland or O-ring.

4) WEAK DRIVING FORCE

(1) Symptom and cause.

Weak scraping and shearing force of loader under normal oil temperature of transmission. One cause may be broken differential axis.

(2) Measures.

First determine which of the differential axle of front axle or rear axle is broken. Turn down the bucket to make the front wheels to rise away from the ground and then change to reverse gear and step on it gradually to observe whether the loader can travel or not. If the loader can not travel and rear driving axle turns, the rear differential axle may be broken.