

## GROUP 3 MONITORING SYSTEM

### 1. CLUSTER

The gauges panel consists of gauges and monitors as shown below, to warn the operator in case of abnormal machine operation or conditions for the appropriate operation and inspection.

- Gauges : Indicate operating status of the machine.
- Warning lamp : Indicate abnormality of the machine.
- Pilot lamp : Indicate operating status of the machine.

※ **The monitor installed on this machine does not entirely guarantee the condition of the machine. Daily inspection should be performed according to chapter 6, Maintenance.**

※ **When the monitor provides a warning immediately check the problem, and perform the required action.**

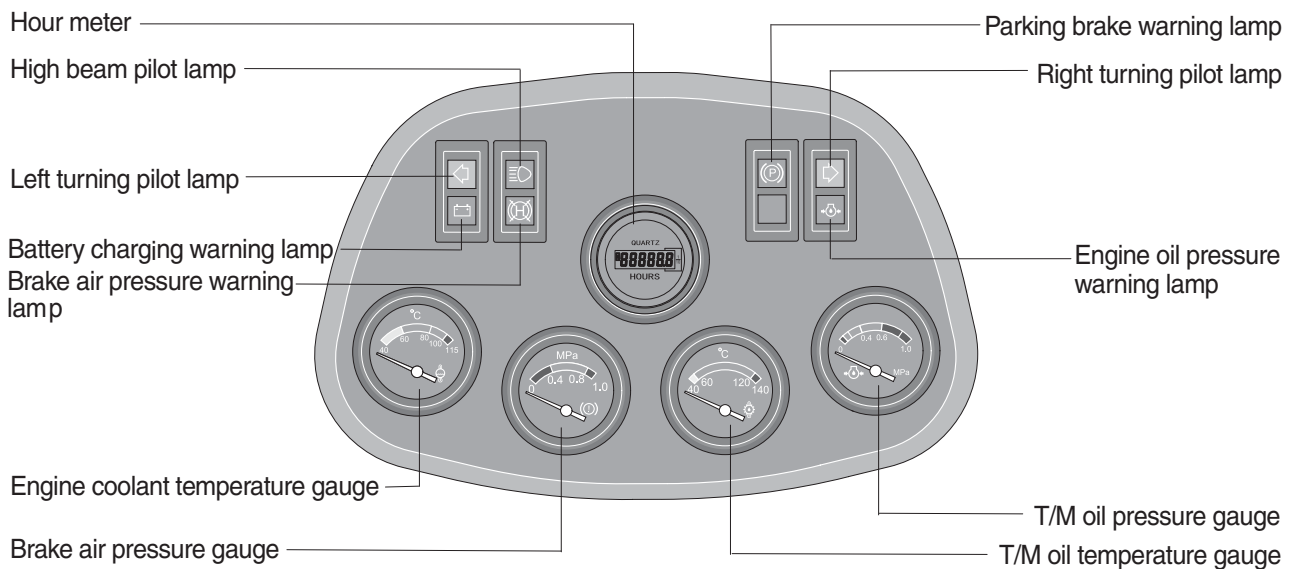

850S3CD02

### 1) HOUR METER

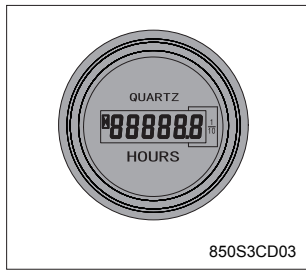

- (1) This gauge indicates the working time of engine. Its reading can be used as repair and maintenance basis.

### 2) ENGINE COOLANT TEMPERATURE GAUGE

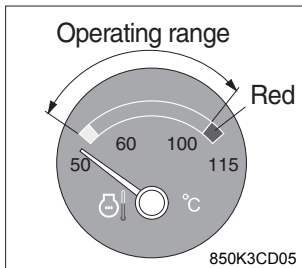

- (1) This gauge indicates the temperature of coolant.  
Red range : Above 100°C
- (2) If the indicator is in operating range, it is normal.
- (3) Keep idling engine at low speed until the indicator is in the operating range.
- (4) If the indicator is in the red range, keep idling engine at low speed for 5 minutes, turn off the engine and check the radiator and engine.

### 3) TRANSMISSION OIL TEMPERATURE GAUGE

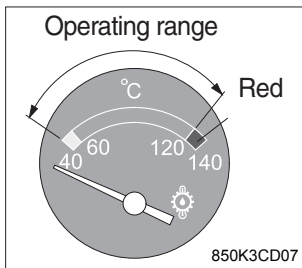

- (1) This gauge indicates the temperature of transmission oil.  
Red range : Above 120°C
- (2) If the indicator is in operating range, it is normal.
- (3) Keep idling engine at low speed until the indicator is in the operating range.
- (4) If the indicator is in the red range, it means the transmission is overheated. Be careful that the indicator does not move into the red range.

### 4) TRANSMISSION OIL PRESSURE GAUGE

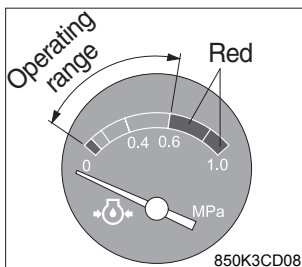

- (1) This gauge indicates the pressure of transmission oil.
- (2) If the indicator is in operating range, it is normal.
- (3) If the indicator is in the red range, stop the engine and check the transmission system.

## 5) BRAKE AIR PRESSURE GAUGE

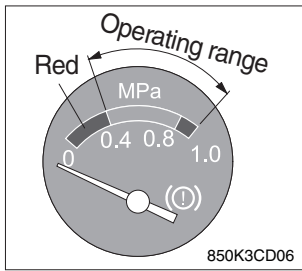

- (1) This gauge indicates the air pressure of service brake.
  - Red range : Below 0.4 MPa
- (2) If the indicator is in operating range, it is normal.
- (3) If the indicator is in the red range, keep idling engine at low speed until the operating range indicates.

## 6) DIRECTION PILOT LAMP

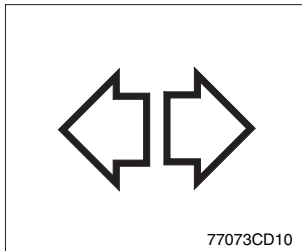

- (1) This lamp flashes when the signal indicator lever is moved.
- (2) When the lamp lights up, the alarm (50 dB) sounds.

## 7) HIGH BEAM PILOT LAMP

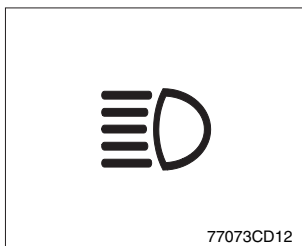

- (1) This lamp works when the illuminating direction is upward.
- (2) This lamp comes ON when the dimmer switch is operated, e.g., when passing another vehicle.

## 8) PARKING BRAKE WARNING LAMP

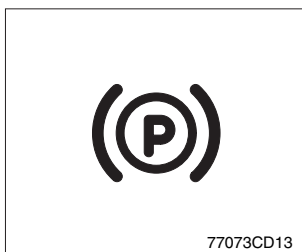

- (1) When the parking brake is actuated, the lamp lights ON.
  - ※ Check the lamp is OFF before driving.

## 9) BRAKE AIR PRESSURE WARNING LAMP

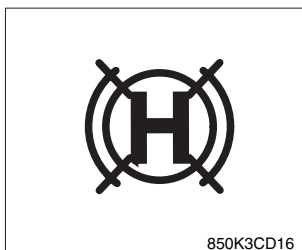

- (1) The lamp lights ON when the air pressure of service brake drops below the normal range.
- (2) When the lamp is ON, stop the engine and check for its cause.
  - ※ Do not operate until any problems are corrected.

## 10) ENGINE OIL PRESSURE WARNING LAMP

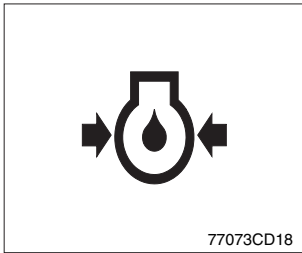

- (1) In the oil pump pressure supply every part will be lubrication at the same time. This lamp is comes ON after starting the engine because of the low oil pressure. When the engine starts normally will automatically turn off the lamp.
- (2) If the lamp comes ON during engine operation, shut OFF engine immediately. Check oil level.

## 11) BATTERY CHARGING WARNING LAMP

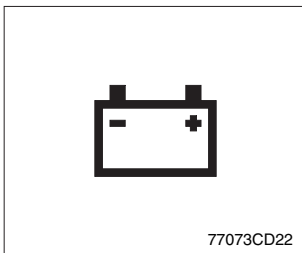

- (1) This lamp is ON when key ON, it is turned OFF after starting the engine.
- (2) Check the battery charging circuit when this lamp comes ON during engine operation.

## 2. SWITCHES

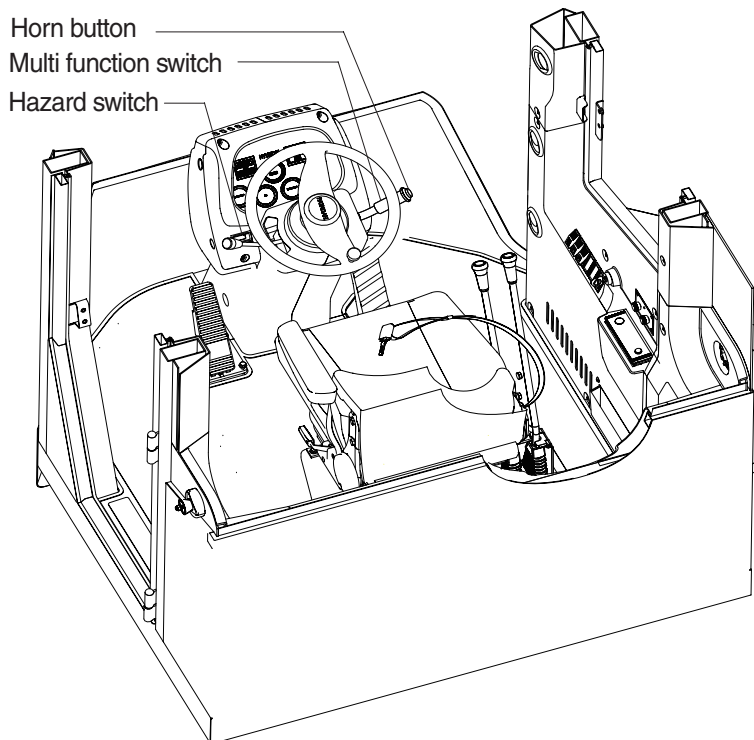
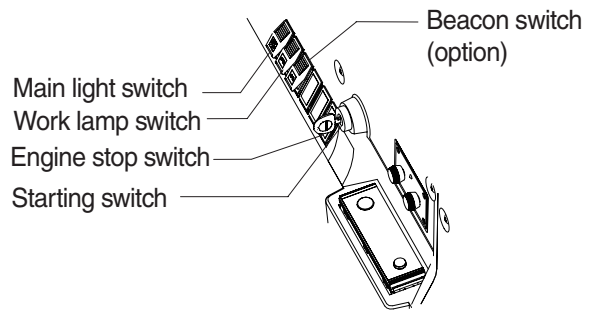

733S3CD04

### 1) STARTING SWITCH



- (1) There are three positions, OFF, ON and START.
- ○ (OFF) : None of electrical circuits activate.
  - | (ON) : All the systems of machine operate.
  - Ⓚ (START) : Use when starting the engine. Release key immediately after starting.

## 2) HAZARD SWITCH

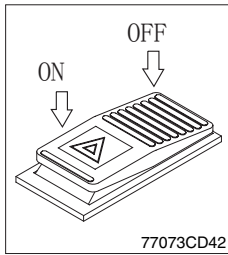

- (1) Use for parking, or roading machine.
- (2) Both turn signal lights will flash simultaneously.

※ If the switch is left ON for a long time, the battery may be discharged.

## 3) WORK LAMP SWITCH

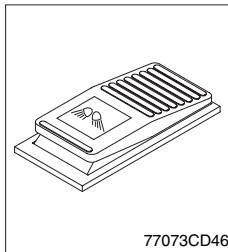

- (1) This switch use to operate the front and rear work lamps by two step.
  - **First step** : Front work lamp located on the cab comes ON.
  - **Second step** : Rear work lamp located on the cowl comes ON.

## 4) MAIN LIGHT SWITCH

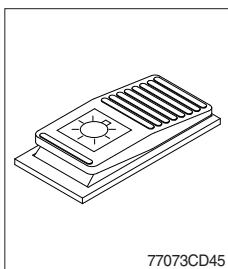

- (1) The switch use to operates the clearance lamp and head light by two step.
  - **First step** : Clearance lamp and cluster illumination lamp comes ON. Also, all indicator lamp of switches come ON.
  - **Second step** : Head light comes ON.

## 5) BEACON SWITCH (option)

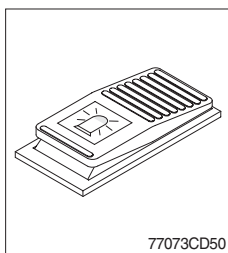

- (1) This switch turns ON the rotary light on the cab.

## 6) HORN BUTTON

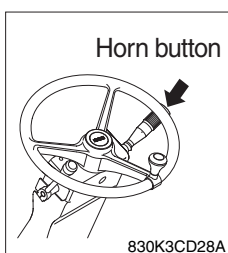

- (1) If you press the button on the top of the multifunction switch, the horn will sound.

## 7) CAB LAMP SWITCH

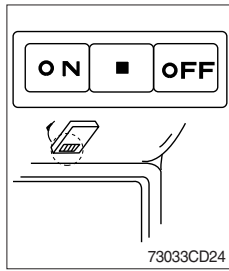

- (1) This switch turns ON the cab room lamp.
- (2) Press ON or OFF can control the lamp.

## 8) MULTI FUNCTION SWITCH

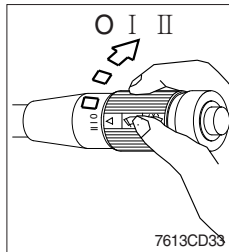

### (1) Front wiper and washer switch

- ① When placed in I or II position, the wiper moves continuously.
- ② If you press a button at the end of the lever, washer liquid will be sprayed and the wiper will be activated 2-3 times.

※ Check the quantity of washer liquid in the tank. If the level of the washer liquid is LOW, add the washer liquid (In cold, winter days) or water. The capacity of the tank is 2.5 liter.

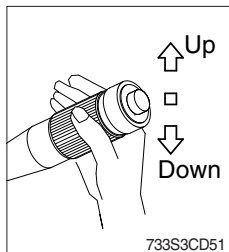

### (2) Dimmer switch

- ① This switch is used to turn the head lights direction.
- ② Switch positions
  - Up : Head lights low beam ON
  - Down : Head lights high beam ON
- ③ If you release the switch when it's in up position, the switch will return to middle.

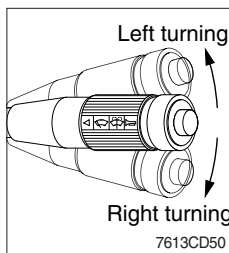

### (3) Turning switch

- ① This switch is used to warn or signal the turning direction of the machine to other vehicles or equipment.
- ② Push the lever up for turning left, pull the lever down for turning right.

## 9) ENGINE STOP SWITCH

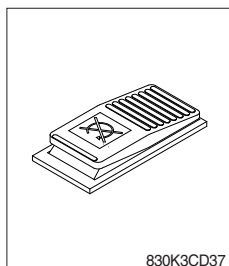

- (1) If the switch is pressed, the engine stops immediately.