

GROUP 4 TESTS AND ADJUSTMENTS

1. HYDRAULIC OIL CLEAN UP PROCEDURE USING PORTABLE FILTER CADDY

- ※ Service equipment and tool
 - Portable filter caddy
 - Two 4000 mm × 1in 100R1 Hoses
 - Quick disconnect fittings.
 - Discharge wand
 - Various size fittings.
 - ※ Flush all lines in the steering system and cut off system. Disassemble and clean major components for steering system.
Steering components may fail if steering system is not cleaned after hydraulic oil tank contamination.
- 1) If hydraulic system is contaminated due to a major component failure, remove and disassemble steering cylinders to clean debris from cylinders.
 - 2) Install a new return filter element. Inspect filter housing before installing new element.
 - ※ For a failure that creates a lot of debris, remove access cover from hydraulic oil tank. Drain and clean hydraulic oil tank of fill the specified oil to hydraulic oil tank through upper cover.
 - 3) To minimize oil loss, pull a vacuum in hydraulic oil tank using a vacuum pump. Connect filter caddy suction line to drain port at bottom of hydraulic oil tank using connector. Check to be sure debris has not closed drain port.
 - 4) Put filter caddy discharge line into hydraulic oil tank filler hole so end is as far away from drain port as possible to obtain a thorough cleaning of oil.

5) Start the filter caddy. Check to be sure oil is flowing through the filters.

Operate filter caddy approximately 10 minutes so oil in hydraulic oil tank is circulated through filter a minimum of four times.

※ Hydraulic oil tank capacity : 95 l (25.0 U.S. gal)

Leave filter caddy operation for the next steps.

6) Start the engine and run it at high idle.

※ For the most effective results, cleaning procedure must start with the smallest capacity circuit then proceed to the next largest capacity circuit.

7) Operate all functions, one at a time, through a complete cycle in the following order : Steering, bucket, and boom. Also include all auxiliary hydraulic functions.

Repeat procedure until the total system capacity has circulated through filter caddy seven times, approximately 30 minutes.

Each function must go through a minimum of three complete cycles for a through cleaning for oil.

※ Filtering time for machines with auxiliary hydraulic functions must be increased because system capacity is larger.

8) Stop the engine. Remove the filter caddy.

9) Install a new return filter element.

10) Check oil level in reservoir; Add oil if necessary.

2. TEST TOOLS

1) CLAMP-ON ELECTRONIC TACHOMETER INSTALLATION

- Service equipment and tools
- Tachometer

A : Clamp on tachometer.

Remove paint using emery cloth and connect to a straight section of injection line within 100 mm (4 in) of pump. Finger Tighten only-do not over tighten.

B : Black clip (-). Connect to main frame.

C : Red clip (+). Connect to transducer.

D : Tachometer readout. Install cable.

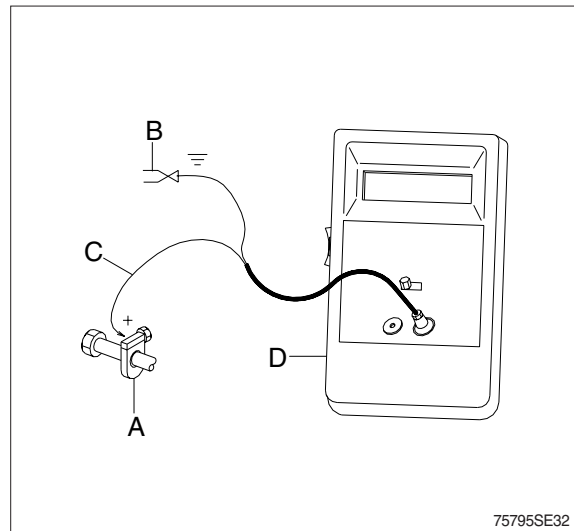

2) DIGITAL THERMOMETER INSTALLATION

- Service equipment and tools
- Digital thermometer

A : Temperature probe.

Fasten to a bare metal line using a tie band. Wrap with shop towel.

B : Cable.

C : Digital thermometer.

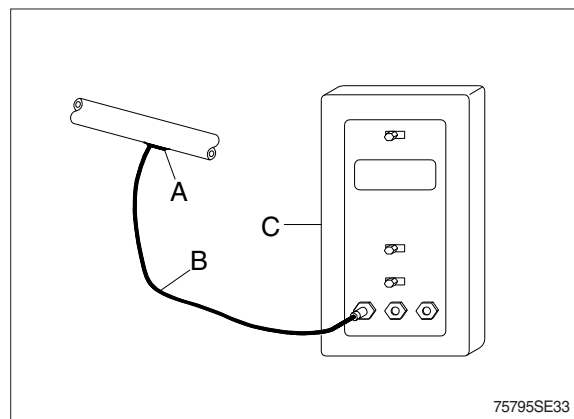

3. HYDRAULIC OIL WARM UP PROCEDURE

- 1) Install temperature reader (see temperature reader installation procedure in this group).
- 2) Run engine at high idle.
- 3) Hold a hydraulic function over relief to heat the oil.
- 4) Periodically cycle all hydraulic functions to distribute warm oil.
- 5) Heat oil to test specification (approx. 45°C).

4. MAIN HYDRAULIC PUMP FLOW TEST

· SPECIFICATION

Oil temperature	$45 \pm 5^{\circ}\text{C}$ ($113 \pm 9^{\circ}\text{F}$)
Engine speed	2200 ± 25 rpm
Test pressure	160 ± 5 bar (2280 psi)
Maximum pump flow	169 l /min (44.6 gpm)

· FLOW METER AND TOOL

Flow meter	300 l /min (79.3 gpm)
Temperature reader	

- 1) Make test connections.
- 2) Install temperature reader.
(see temperature reader installation procedure in this group)
- 3) Heat hydraulic oil to specifications.
(see hydraulic oil warm up procedure in this group)
- 4) Run engine at test specifications.
- 5) Close flow meter loading valve to increase pressure to test specifications.
- 6) Read flow meter.
- 7) If flow is below specifications, check suction line and suction pressure for abnormality before removing pump.

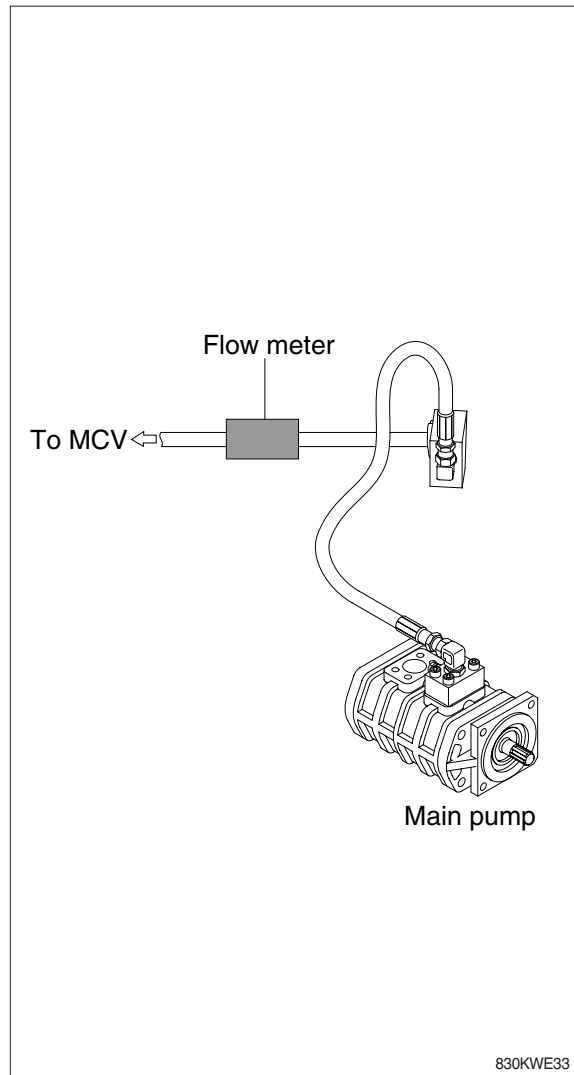

5. LOADER SYSTEM AND PORT RELIEF VALVE PRESSURE TEST

· SPECIFICATION

Oil temperature (40~50°C)

Relief valve	Engine speed	Relief pressure
System (M)	Low	160 ± 5 kg/cm ² (2280 ± 70 psi)
Bucket rollback (R)	Low	180 ± 5 kg/cm ² (2560 ± 70 psi)
Bucket dump (D)	Low	120 ± 5 kg/cm ² (1710 ± 70 psi)

· Gauge and tool

Gauge 0~35 MPa (0~350 bar, 0~5000 psi)

M : System (main) relief valve

R : Bucket rollback relief

D : Bucket dump relief

- 1) Install fitting and pressure gauge to test port in pump delivery line.
 - 2) Install temperature reader.
(see temperature reader installation procedure in this group)
 - 3) Heat hydraulic oil to specifications.
(see hydraulic oil warm up procedure in this group)
 - 4) To check the system relief (M), run engine at low idle. Lower boom to bottomed position.
Slowly activate boom down function while watching pressure gauge. If pressure is not to specification, loosen lock nut on system relief valve (M) and adjust to specification.
- ※ Do not adjust the system relief valve above 160 kg/cm² (2280 psi). Damage to the pump will result from excessive pressure settings.

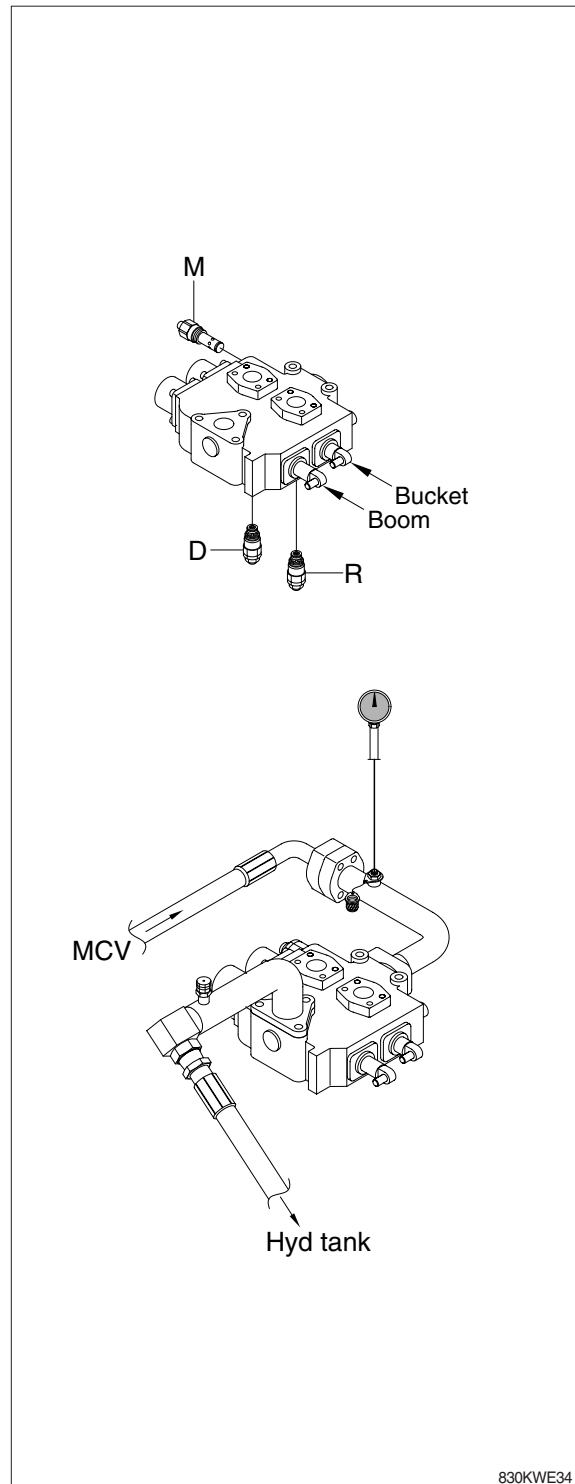

830KWE34

6. HYDRAULIC SYSTEM RESTRICTION TEST

· SPECIFICATION

Oil temperature $45 \pm 5^\circ\text{C}$ ($113 \pm 9^\circ\text{F}$)

Engine speed High idle

Maximum pressure

3 MPa (30 bar, 43 psi) at steering unit

Maximum pressure at main control valve

1 MPa (10 bar, 145 psi)

· GAUGE AND TOOL

Gauge 0~7 MPa (0~70 bar, 0~1000 psi) 2EA

This test will check for restrictions in the hydraulic system which can cause overheating of hydraulic oil.

- 1) Install temperature reader.
(see temperature reader installation procedure in this group)
- 2) Heat hydraulic oil to specifications.
(see hydraulic oil warm up procedure in this group)
- 3) Connect fitting and gauge to steering valve.
- 4) Connect fitting and gauge to main control valve.

▲ Do not operate steering or loader functions or test gauge may be damaged.

- 5) Run engine at specification and read pressure gauges.

If pressure is more than specification at the loader control valve, check for a kinked, dented or obstructed hydraulic line. Check loader control valve for a binding spool.

If pressure is more than specification at the steering unit, inspect neutral condition of the steering unit and priority valve for a stuck spool. Make sure orifice plugs are installed in ends of priority valve spool.

Check for plugged orifice in priority valve LS port and dynamic signal orifice on the spool of priority valve.

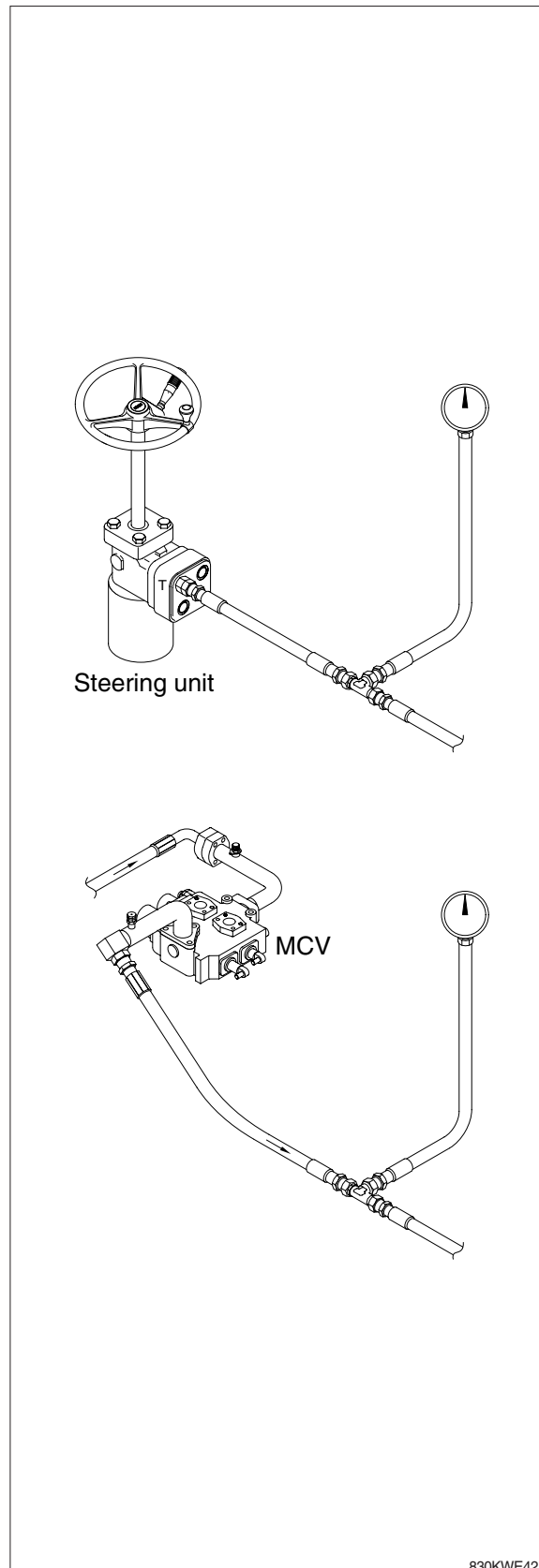

830KWE42

7. LOADER CYLINDER DRIFT TEST

· SPECIFICATION

Oil temperature $45 \pm 5^{\circ}\text{C}$ ($113 \pm 9^{\circ}\text{F}$)

Boom horizontal

Bucket horizontal

Bucket unloaded

Item	Standard value
Retraction of boom cylinder rod	36 mm
Retraction of bucket cylinder rod	33 mm

· GAUGE AND TOOL

Stop watch

Temperature reader

▲ Put the safety lock lever in the lock position.

▲ Do not go under the work equipment.

- 1) Set the boom and bucket horizontal, then stop the engine.
- 2) Stop the engine, wait for 5 minutes, then start measuring.
- 3) Measure the amount the boom and bucket cylinder rods retract during 5 minutes.

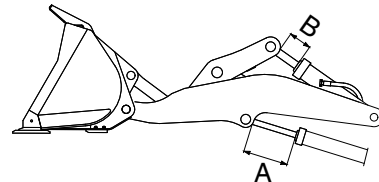

A : Retraction of boom cylinder rod

B : Retraction of bucket cylinder rod

7577AWE31

8. BOOM AND BUCKET CYLINDER LEAKAGE TEST

· SPECIFICATION

Oil temperature $45 \pm 5^{\circ}\text{C}$ ($113 \pm 9^{\circ}\text{F}$)
Engine speed Low idle
Maximum leakage 15 ml/min (1/2 oz/min)

· GAUGE AND TOOL

Temperature reader
Stop watch
Measuring container

1) Fasten temperature sensor to head end port of cylinder to be tested. Cover sensor with a shop towel.

2) Heat hydraulic oil to specifications (see hydraulic oil warm up procedure in this group).

⚠ Never work under raised equipment unless it is supported with a hoist or support stands.

3) Full extend the cylinder to be tested. If testing the boom cylinders, restrain boom in the fully raised position using a hoist or a stand.

※ Check cylinders for leakage in the fully extended position only. In the retracted position contacts the end of the cylinder and seals off piston seal leakage.

4) Remove and plug cylinder rod end hose or line.

5) Run engine at slow idle. Activate control lever to extend cylinder for 1 minute over relief while measuring leakage for open port.

If leakage is within specification, excessive cylinder drift is caused by leakage in the loader control valve or circuit relief valve.

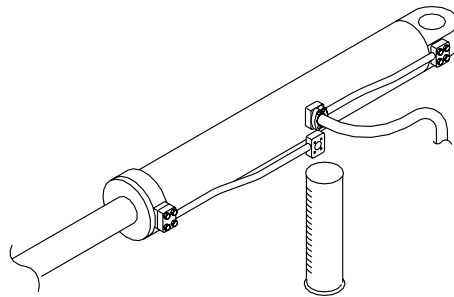

(770-3ATM) 6-56

9. CYCLE TIME TEST

· SPECIFICATION

Oil temperature — $45 \pm 5^{\circ}\text{C}$ ($113 \pm 9^{\circ}\text{F}$)

Engine speed — High idle

Function	Operating conditions	Maximum cycle time (seconds)
Boom raise	Bucket flat on ground to full height	5.1
Boom lower (float)	Full height to ground level	3.0
Bucket dump	Boom at full height	1.1
Bucket rollback	Boom at full height	1.5
Steering (number of turns)	Frame stop to stop	6.1 turns

10. HYDRAULIC OIL FILTER INSPECTION PROCEDURE

- 1) Lower the bucket to the ground, stop the engine, move the control lever back and forth several times, and clean all over the upper surface of the hydraulic oil tank.
- 2) Remove the bolts and take out the filter case cover and O-ring.
- 3) Remove the spring and bypass valve.
- 4) Remove the filter element from the tank.
- 5) Check the element and the filter case bottom for debris. Excessive amounts of brass and steel particles can indicate a failed hydraulic pump or a pump failure in process. A rubber type of material can indicate cylinder packing or other packing failure.

※ The hydraulic oil filter in the filter case of the hydraulic oil tank should be replaced every 1000 operating hours or more often. When the filter element is replaced, please keep as follows.

- (1) Clean the inside of the filter case.
- (2) Place new element in the proper positions inside the filter case.
- (3) Install the bypass valve and spring. Make sure the element stand upright, and check for complete contact of the element bottom with the filter case bottom.
- (4) Install the O-ring and filter case covers. Tighten them with bolt. Replace the O-ring with new one if damaged.

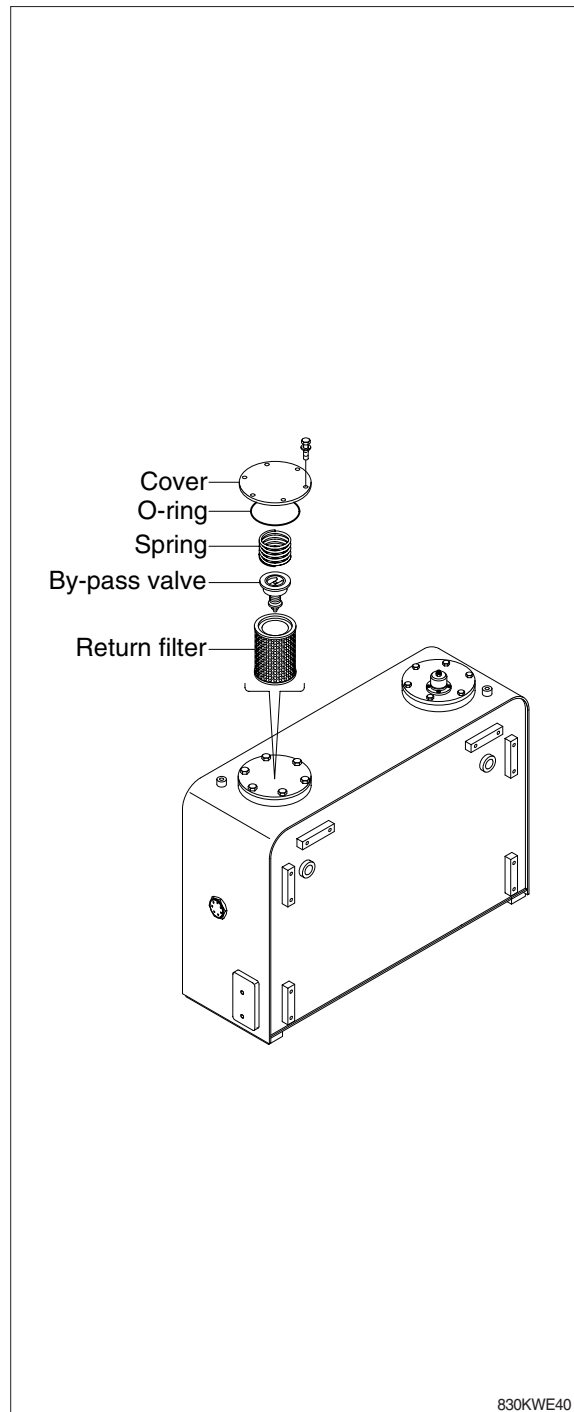

830KWE40