

GROUP 5 COMBINED OPERATION

1. OUTLINE

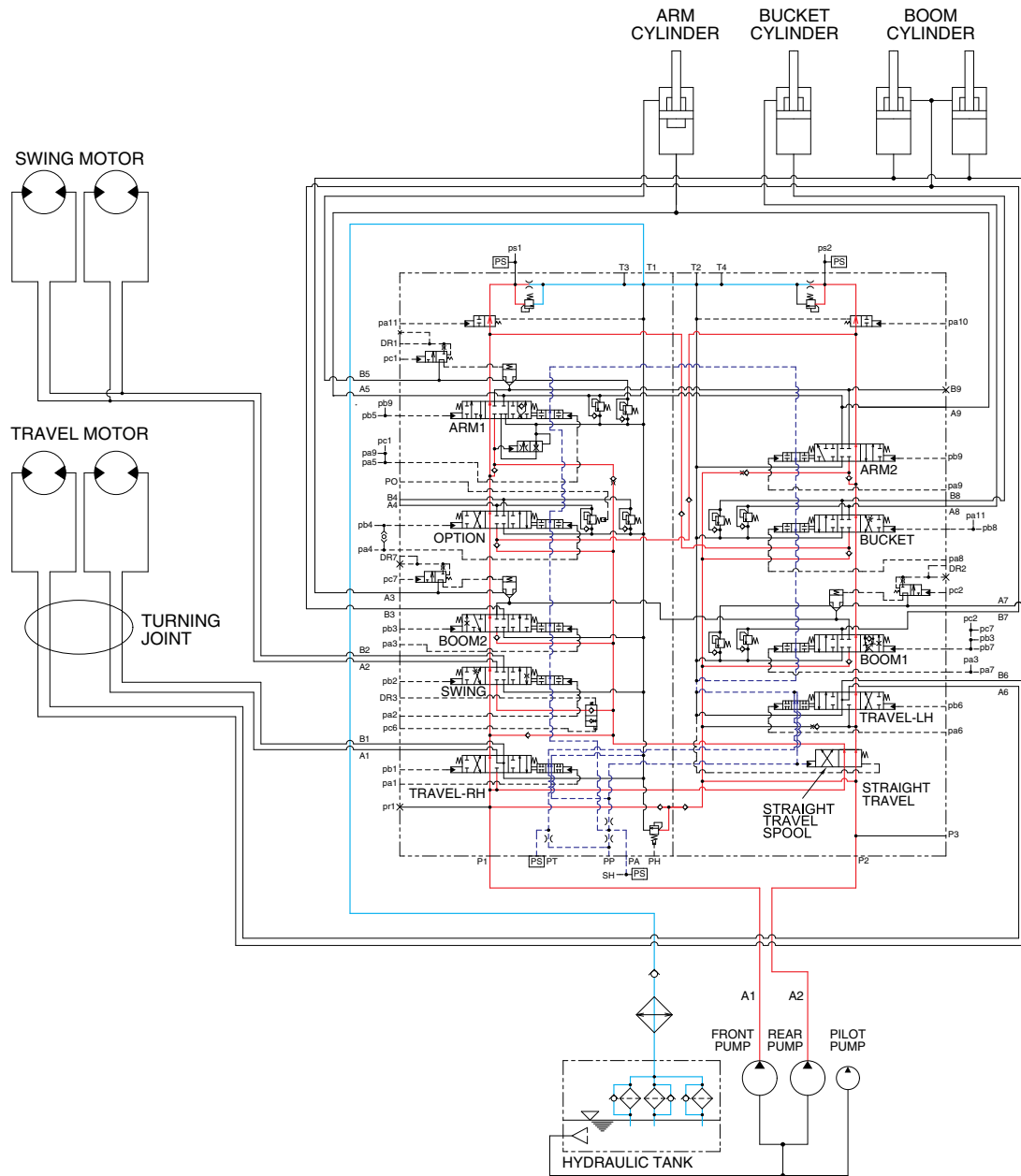

80093HC20

The oil from the A1 and A2 pump flows through the neutral oil passage, bypass oil passage and confluence oil passage in the main control valve. Then the oil goes to each actuator and operates them. Check valves and orifices are located on these oil passage in the main control valve. These control the oil from the main pumps so as to correspond to the operation of each actuator and smooth the combined operation.

STRAIGHT TRAVEL SPOOL

This straight travel spool is provided in the main control valve.

If any actuator is operated when traveling, the straight travel spool is pushed to the right by the pilot oil pressure from the pilot pump.

Consequently, the left and right travel oil supply passage are connected, and equivalent amount of oil flows into the left and right travel motors. This keeps the straight travel.

2. COMBINED SWING AND BOOM UP OPERATION

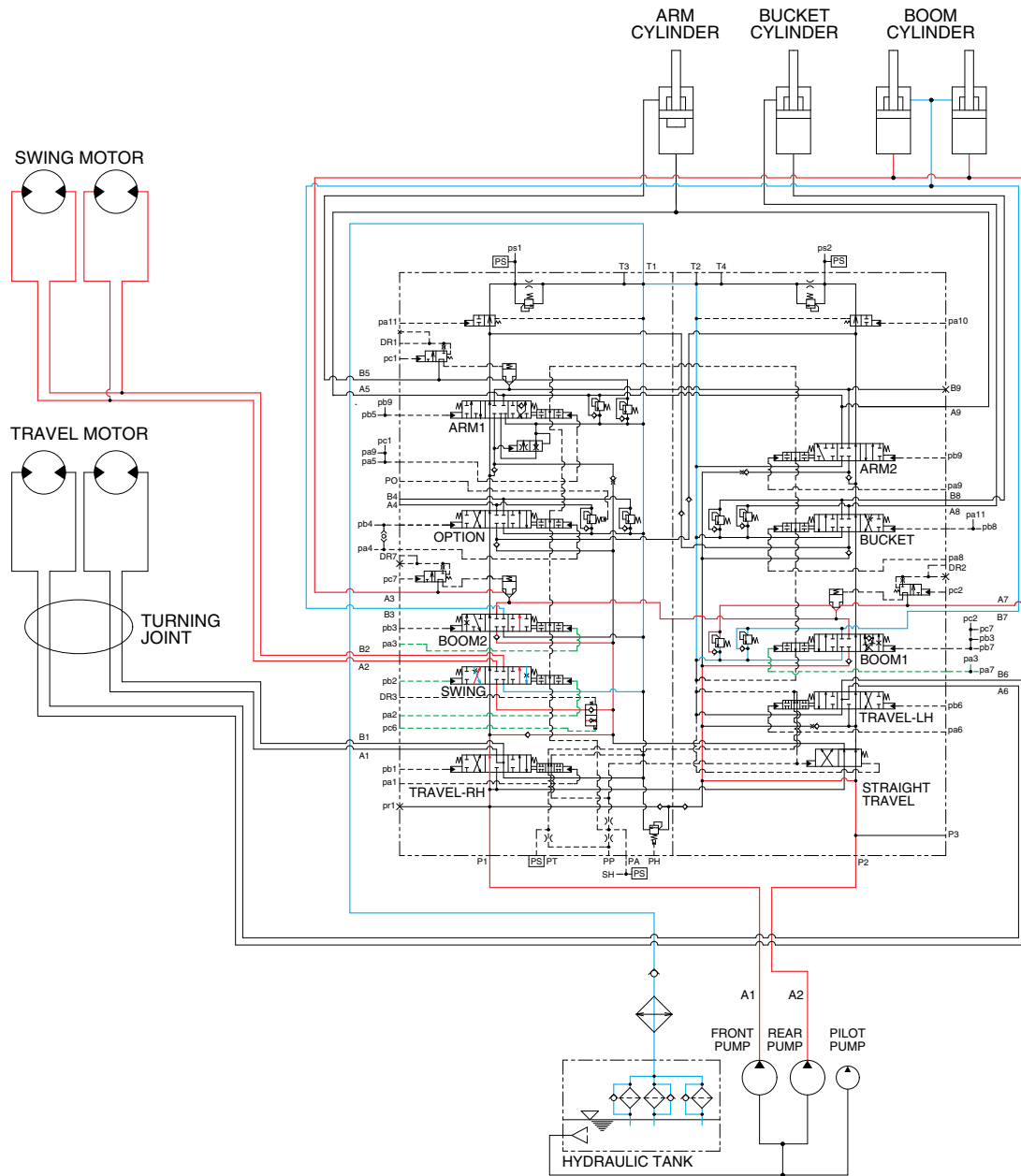

80093HC21

When the swing and boom up functions are operated, simultaneously the swing spool and boom spools in the main control valve are moved to the functional position by the pilot oil pressure from the remote control valve.

The oil from the A1 pump flows into the swing motor through swing spool and the boom cylinder through boom 2 spool.

The oil from the A2 pump flows into the boom cylinders through the boom 1 spool in the right control valve. The upper structure swings and the boom is operated.

Refer to page 3-8 for the boom priority system.

3. COMBINED SWING AND ARM OPERATION

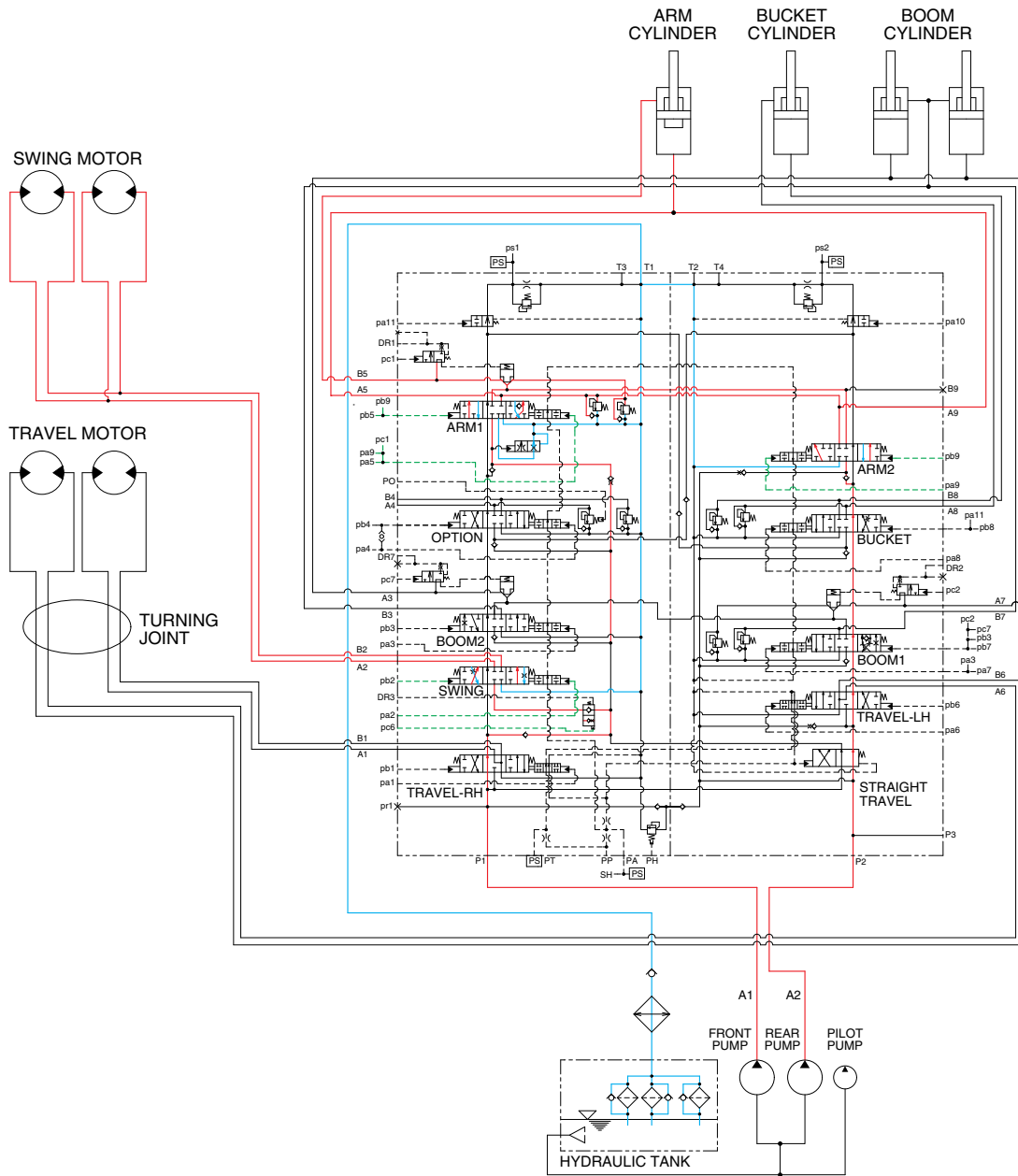

80093HC22

When the swing and arm functions are operated, simultaneously the swing spool and arm spools in the main control valve are moved to the functional position by the pilot oil pressure from the remote control valve.

The oil from the A1 pump flows into the swing motor through swing spool and the arm cylinder through arm 1 spool.

The oil from the A2 pump flows into the arm cylinder through the arm 2 spool of the right control valve. The upper structure swings and the arm is operated.

Refer to page 2-35 for the swing operation preference function.

4. COMBINED SWING AND BUCKET OPERATION

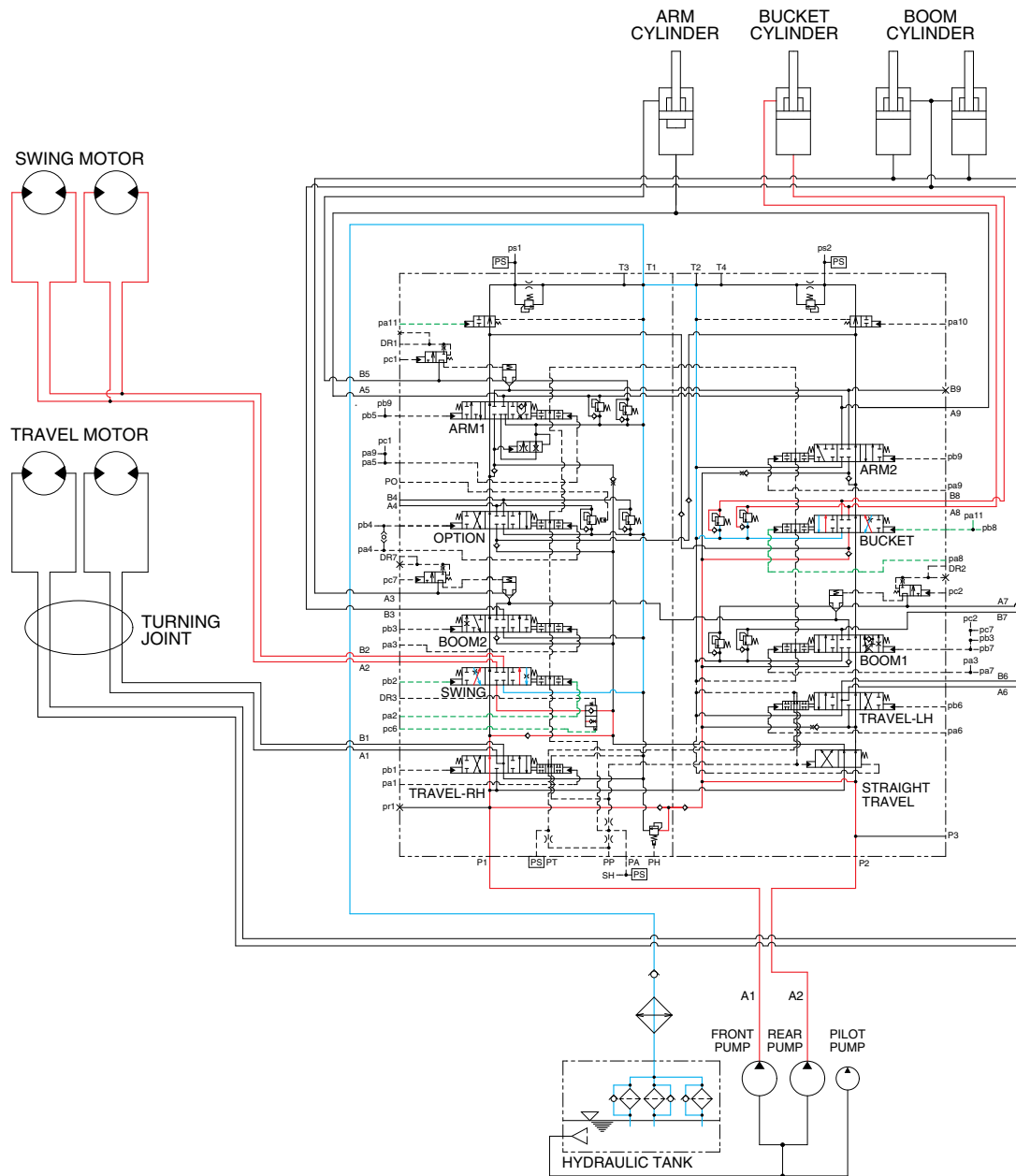

80093HC23

When the swing and bucket functions are operated, simultaneously the swing spool and bucket spool in the main control valve are moved to the functional position by the pilot oil pressure from the remote control valve.

The oil from the A1 pump flows into the swing motor through the swing spool in the left control valve. The oil from the A2 pump flows into the bucket cylinder through the bucket spool in the right control valve.

The upper structure swings and the bucket is operated.

5. COMBINED SWING AND TRAVEL OPERATION

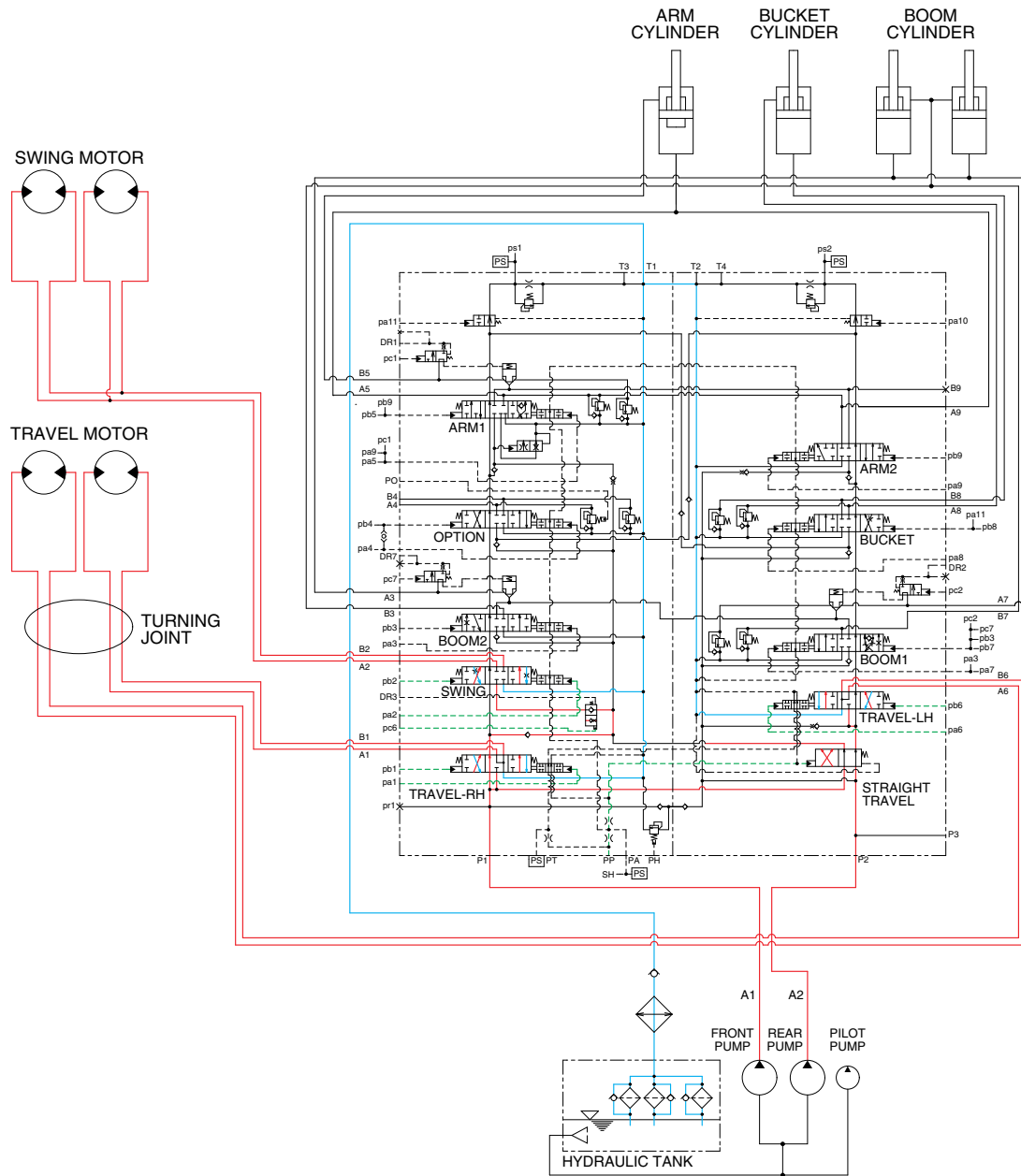

80093HC24

When the swing and travel functions are operated, simultaneously the swing spool and travel spools in the main control valve are moved to the functional position by the pilot oil pressure from the remote control valve and straight travel spool is pushed to the right by the pilot oil pressure from the pilot pump.

The oil from the A1 pump flows into the travel motors through the RH travel spool of the left control valve and the LH travel spool of the right control valve via the straight travel spool.

The oil from the A2 pump flows into the swing motor through the swing spool.

The upper structure swings and the machine travels straight.

6. COMBINED BOOM AND TRAVEL OPERATION

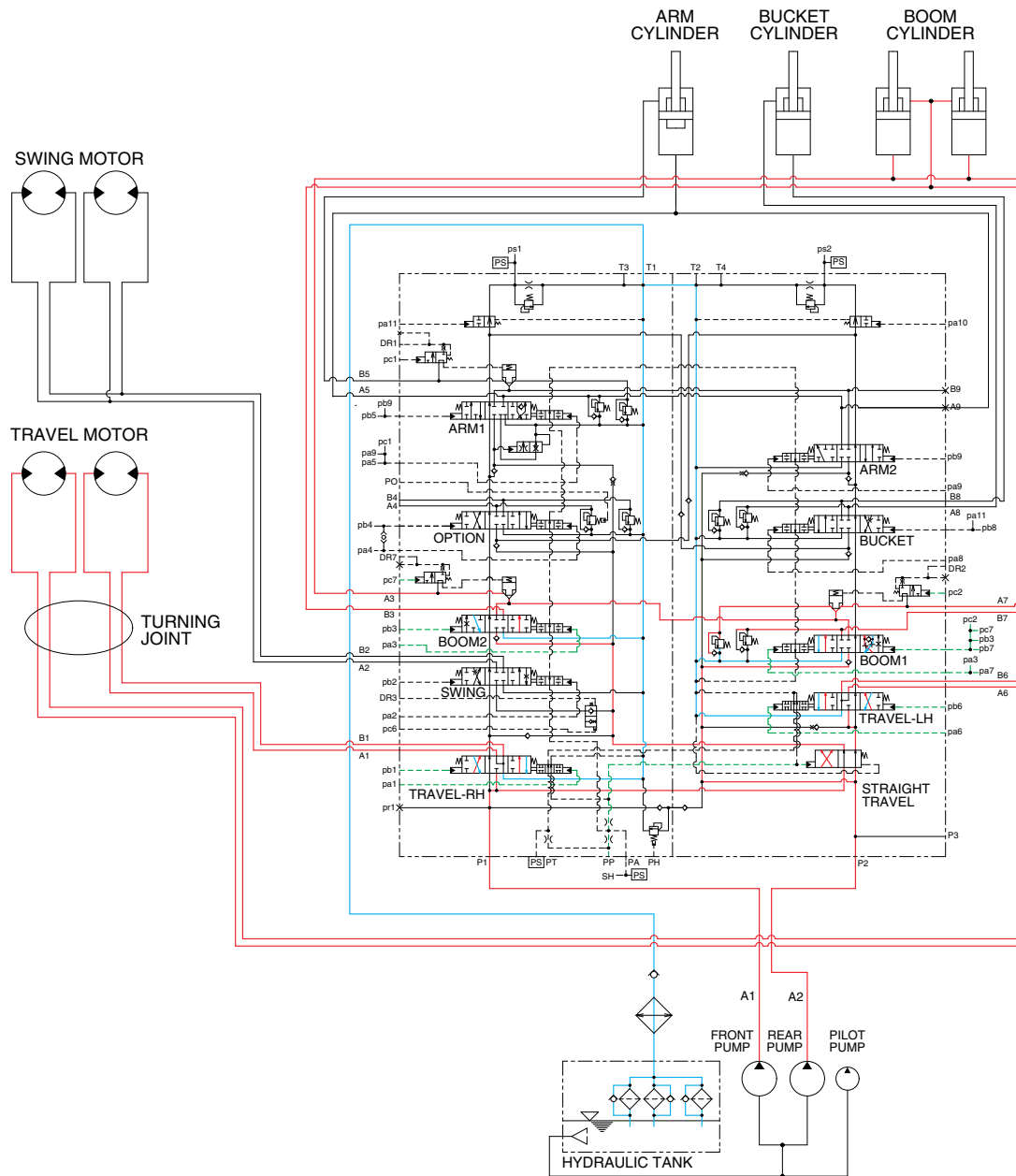

80093HC25

When the boom and travel functions are operated, simultaneously the boom spools and travel spools in the main control valve are moved to the functional position by the pilot oil pressure from the remote control valve and the straight travel spool is pushed to the right by the oil pressure from pilot pump.

The oil from the A1 pump flows into the travel motors through the RH travel spool of the left control valve and the LH travel spool of the right control valve via the straight travel spool.

The oil from the A2 pump flows into the boom cylinders through the boom 2 spool and boom 1 spool via the parallel and confluence oil passage in case boom up operation.

The boom is operated and the machine travels straight.

7. COMBINED ARM AND TRAVEL OPERATION

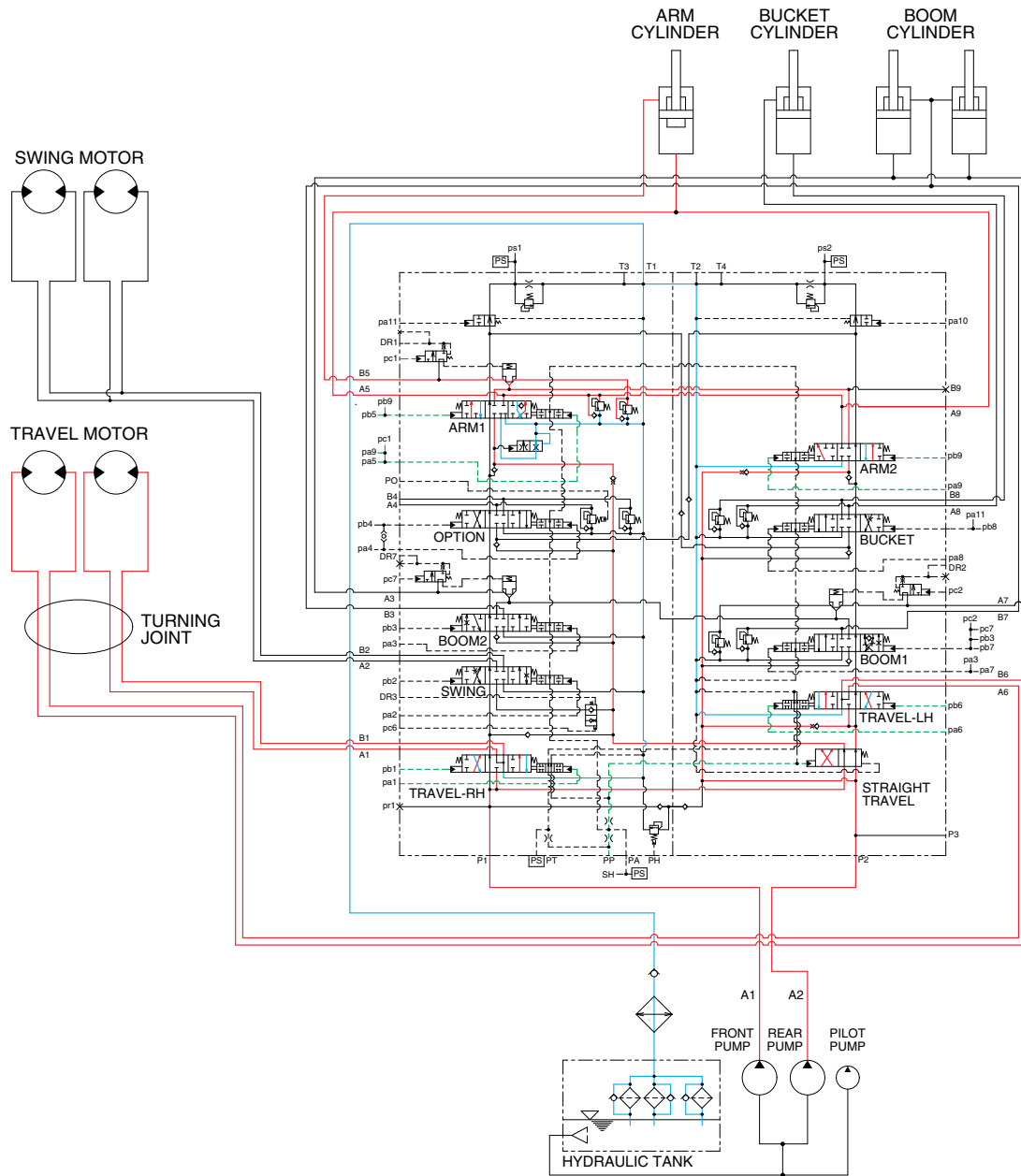

80093HC26

When the arm and travel functions are operated, simultaneously the arm spools and travel spools in the main control valve are moved to the functional position by the pilot oil pressure from the remote control valve and the straight travel spool is pushed to the right by the oil pressure from pilot pump. The oil from the A1 pump flows into the travel motors through the RH travel spool of the left control valve and the LH travel spool of the right control valve via the straight travel spool. The oil from the A2 pump flows into the arm cylinders through the arm 1 spool and arm 2 spool via the parallel and confluence oil passage. The arm is operated and the machine travels straight.

8. COMBINED BUCKET AND TRAVEL OPERATION

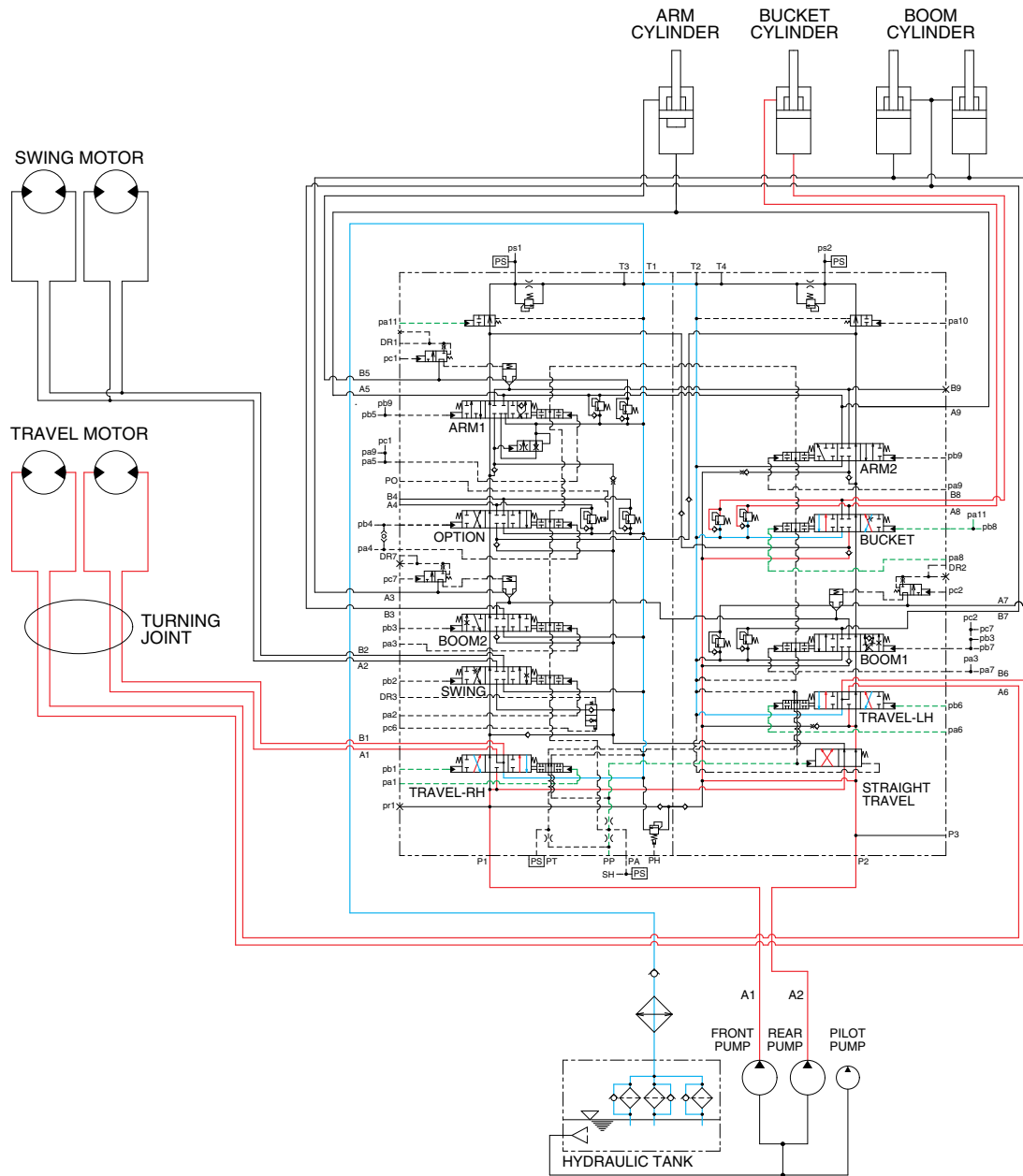

80093HC27

When the bucket and travel functions are operated, simultaneously the bucket spool and travel spools in the main control valve are moved to the functional position by the pilot oil pressure from the remote control valve, and the straight travel spool is pushed to the right by the oil pressure from pilot pump. The oil from the A1 pump flows into the travel motors through the RH travel spool of the left control valve and the LH travel spool of the right control valve via the straight travel spool of the control valve.

The oil from the A2 pump flows into the bucket cylinder through the bucket spool via the confluence oil passage.

The bucket is operated and the machine travels straight.