

GROUP 10 ANTI-RESTART SYSTEM

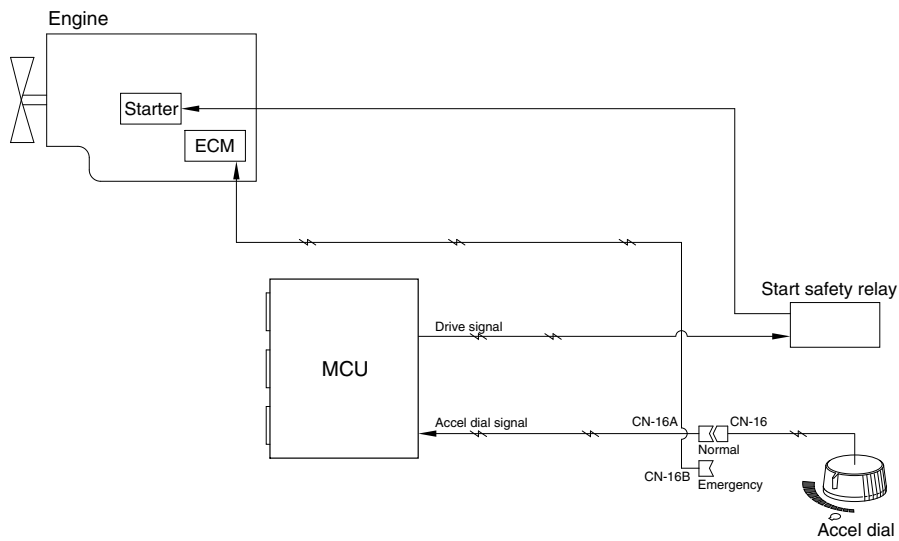

80095MS12

1. ANTI-RESTART FUNCTION

After a few seconds from the engine starts to run, MCU turns off the start safety relay to protect the starter from inadvertent restarting.

2. When a replacement or taking-off of the MCU is needed, connect CN-16 and CN-16B to ensure the engine start without the MCU.