

SECTION 4 ELECTRICAL SYSTEM

Group 1 Component Location	4-1
Group 2 Monitoring system	4-3
Group 3 Electrical Circuit	4-30
Group 4 Electrical Component Specification	4-47
Group 5 Connectors	4-54
Group 6 Fault codes	4-71

SECTION 4 ELECTRICAL SYSTEM

GROUP 1 COMPONENT LOCATION

1. LOCATION 1

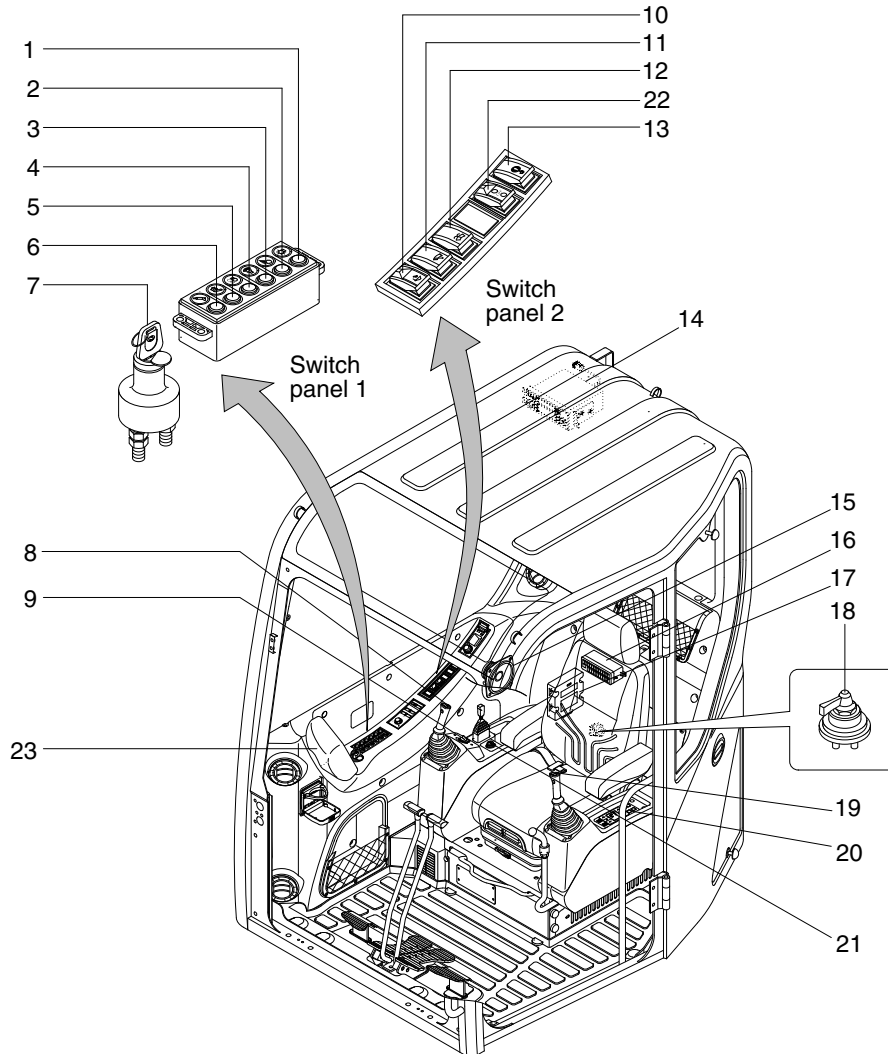

80CR9A4EL20

- | | | | | | |
|---|--------------------------------|----|-----------------------|----|----------------------------|
| 1 | Head light switch | 9 | Accel dial switch | 17 | Machine control unit |
| 2 | Work light switch | 10 | Quick clamp switch | 18 | Master switch |
| 3 | Travel alarm switch | 11 | Wiper switch | 19 | Horn switch |
| 4 | Cab light switch | 12 | Washer switch | 20 | Aircon & heater controller |
| 5 | Beacon switch | 13 | Overload switch (opt) | 21 | Cigar lighter |
| 6 | Breaker selection switch (opt) | 14 | Radio & USB player | 22 | DPF switch |
| 7 | Start switch | 15 | Speaker | 23 | Cluster |
| 8 | Breaker operation switch (opt) | 16 | Fuse box | | |

2. LOCATION 2

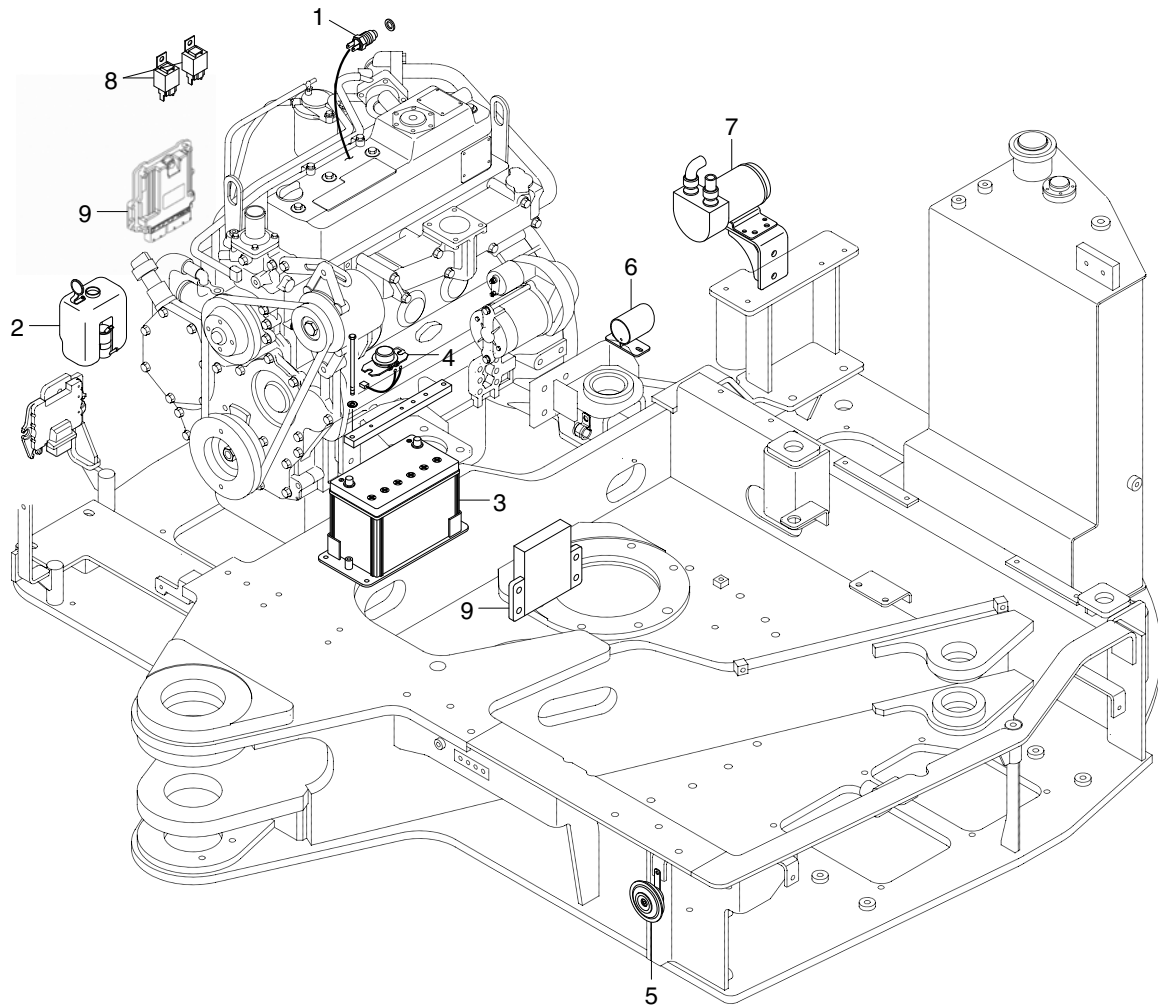

80CR9A4EL03

- 1 Water temp sender
- 2 Washer tank assy
- 3 Battery
- 4 Battery relay
- 5 Horn

- 6 Back buzzer
- 7 Fuel filler pump
- 8 Power relay
- 9 Engine control unit

GROUP 2 MONITORING SYSTEM (machine serial No.: ~#1364)

1. OUTLINE

Monitoring system consists of the monitor part and switch part.

The monitor part gives warnings when any abnormality occurs in the machine and informs the condition of the machine.

Various select switches are built into the monitor panel, which act as the control portion of the machine control system.

2. CLUSTER

1) STRUCTURE

The cluster consists of LCD and switches as shown below. The LCD is to warn the operator in case of abnormal machine operation or conditions for the appropriate operation and inspection.

Also, The LCD is to set and display for modes, monitoring and utilities with the switches.

The switches or touch screen are to set the machine operation modes.

- ※ The cluster installed on this machine does not entirely guarantee the condition of the machine. Daily inspection should be performed according to chapter 6, Maintenance.
- ※ When the cluster provides a warning immediately check the problem, and perform the required action.



80CR9A4EL21

- ※ The warning lamp pops up, lights ON (on the left-top side) and the buzzer sounds when the machine has a problem.
The warning lamp lights ON until the problem is cleared. Refer to page 4-6 for details.

2) GAUGE

(1) Operation screen

When you first turn starting switch ON, the operation screen will appear.



- | | | | | | |
|---|---------------------------|---|------------------|---|------------|
| 1 | Engine coolant temp gauge | 3 | Fuel level gauge | 5 | Accel dial |
| 2 | Hydraulic oil temp gauge | 4 | Engine rpm | | |



※ Operation screen type can be set by the screen type menu of the display.

Refer to page 4-25 for details.

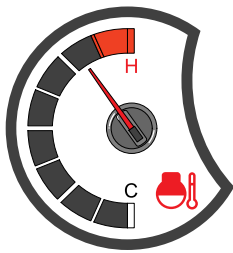
(2) Engine coolant temperature gauge





5513CD07G

- ① This gauge indicates the temperature of coolant.
 - Black range : 40-115°C (104-239°F)
 - Red range : Above 115°C (239°F)
 - ② If the indicator is in the red range or  lamp lights ON in red, turn OFF the engine and check the engine cooling system.
- ※ If the gauge indicates the red range or  lamp lights ON in red even though the machine is on the normal condition, check the electric device as that can be caused by the poor connection of electricity or sensor.

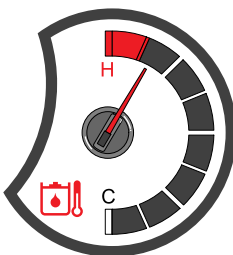
(3) Hydraulic oil temperature gauge





5513CD07E

- ① This gauge indicates the temperature of hydraulic oil.
 - Black range : 40-105°C (104-221°F)
 - Red range : Above 105°C (221°F)
 - ② If the indicator is in the red range or  lamp lights ON in red, reduce the load on the system. If the gauge stays in the red range, stop the machine and check the cause of the problem.
- ※ If the gauge indicates the red range or  lamp lights ON in red even though the machine is on the normal condition, check the electric device as that can be caused by the poor connection of electricity or sensor.

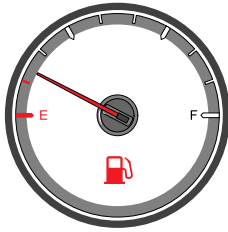
(4) Fuel level gauge



5513CD07F

- ① This gauge indicates the amount of fuel in the fuel tank.
- ② Fill the fuel when the red range, or  lamp lights ON in red.
- ※ If the gauge indicates the red range or  lamp lights ON in red even though the machine is on the normal condition, check the electric device as that can be caused by the poor connection of electricity or sensor.

(5) Engine rpm display

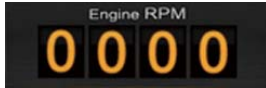

559A3CD35

- ① This displays the engine speed.

(6) Accel dial display

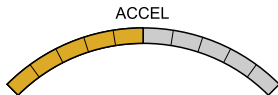

5513CD07C

- ① This displays acceleration dial level from 0 to 10 step.

3) COMMUNICATION ERROR AND LOW VOLTAGE WARNING POP-UP

(1) Communication error pop-up



559A3CD71

- ① Cluster displays this communication error pop-up when it has communication error with MCU.
- ② Communication error pop-up displays at operation screen only. Just buzzer alarm at the other screen.
- ③ If communication with MCU become normal state, it will disappear automatically.

(2) Low voltage warning pop-up



559A3CD72

- ① Cluster displays this low voltage warning pop-up when the battery voltage is low.
- ② Low voltage warning pop-up displays at operation screen only. Just buzzer alarm at the other screen.
- ③ This pop-up will disappear with using touch screen or buzzer stop switch. While the battery voltage is low, buzzer sounds every minute.
- ④ When the battery voltage is higher than 11.5 V, the pop-up off.

4) WARNING LAMPS

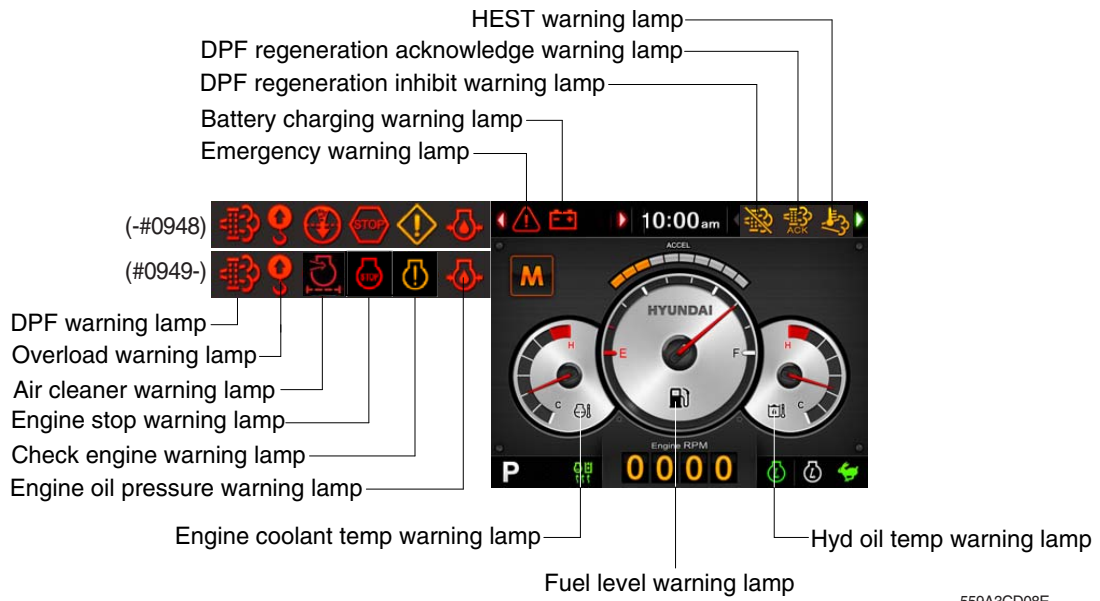



559A3CD08E

- ※ Each warning lamp on the left-top of the LCD pops up on the center of LCD and the buzzer sounds when the each warning is happened. The pop-up warning lamp moves to the original position and lights ON when the buzzer stop switch is pushed or the pop-up is touched. And the buzzer stops. Refer to page 4-14 for the switch.
- ※ When the warning lamps light ON more than 4, you can check all lamps with next page button (◀, ▶) near the warning lamps.

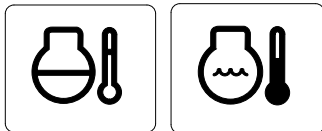

(1) Engine coolant temperature warning lamp

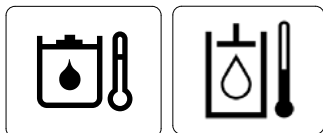

- ① The  lamp pops up on the center of LCD and the buzzer sounds when the engine coolant temperature is over 115°C.
- ② The pop-up  lamp moves to the original position and lights ON when the buzzer stop switch is pushed or pop-up is touched. Also, the buzzer stops and  lamp keeps ON.
- ③ Check the cooling system when the lamp keeps ON.

(2) Hydraulic oil temperature warning lamp



- ① The  lamp pops up on the center of LCD and the buzzer sounds when the hydraulic oil temperature is over 105°C.
- ② The pop-up  lamp moves to the original position and lights ON when the buzzer stop switch is pushed or pop-up is touched. Also, the buzzer stops and  lamp keeps ON.
- ③ Check the hydraulic oil level and hydraulic oil cooling system.

(3) Fuel level warning lamp

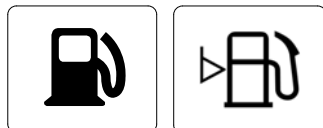

- ① This warning lamp lights ON and the buzzer sounds when the level of fuel is below 10%.
- ② Fill the fuel immediately when the lamp is ON.

(4) Emergency warning lamp



21093CD30

- ① This lamp pops up and the buzzer sounds when each of the below warnings are happened.
 - Engine coolant overheating (over 115°C)
 - Hydraulic oil overheating (over 105°C)
 - MCU input voltage abnormal
 - Accel dial circuit abnormal or open
- ※ The pop-up warning lamp moves to the original position and lights ON when the buzzer stop switch is pushed or pop-up is touched. Also the buzzer stops. This is same as following warning lamps.
- ② When this warning lamp lights ON, machine must be checked and serviced immediately.

(5) Engine oil pressure warning lamp

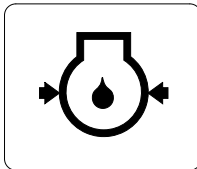

21093CD32

- ① This lamp lights ON when the engine oil pressure is low.
- ② If the lamp lights ON, shut OFF the engine immediately. Check oil level.

(6) Check engine warning lamp

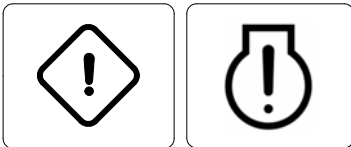

- ① This lamp lights ON when the communication between MCU and engine ECM on the engine is abnormal, or if the cluster received any fault code from engine ECM.
 - ② Check the communication line between them. If the communication line is OK, then check the fault codes on the cluster.
 - ③ Also, this lamp pops up when the level of DPF soot is high.
- ※ Refer to the page 4-8 for the DPF warning lamp.

(7) Battery charging warning lamp

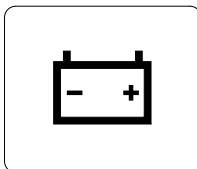

21093CD34

- ① This lamp lights ON when the battery charging voltage is low.
- ② Check the battery charging circuit when this lamp is ON.

(8) Air cleaner warning lamp

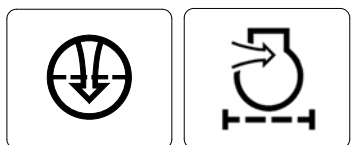

- ① This lamp lights ON when the filter of air cleaner is clogged.
- ② Check the filter and clean or replace it.

(9) Overload warning lamp (opt)

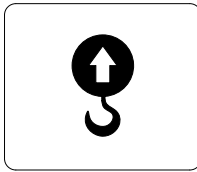

21093CD36



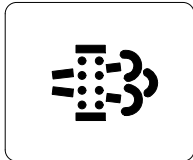

- ① When the machine is overload, the overload warning lamp lights ON during the overload switch is ON. (if equipped)
- ② Reduce the machine load.
Initiate a manual regeneration

(10) DPF (diesel particulate filter) warning lamp



2609A3CD19

- ① This warning lamp lights ON or OFF when the regeneration is needed.
 - ② This warning lamp lights ON while DPF regeneration inhibit switch is in "Regeneration inhibited" state, when stationary regeneration is permitted.
 - ③ This warning lamp lights ON during reset regeneration standby or in back up mode.
 - ④ This warning lamp lights flash during reset regeneration standby DPF regeneration inhibit switch is in "Regeneration inhibited" state.
- ※ Consequences of delaying regeneration
- Poor performance caused by increasing exhaust gas pressure.
 - Higher fuel consumption
 - Shorter filter lifetime

Condition	Warning lamp			Remedy
	DPF 	Check engine  or  (pop up)	Stop engine  or  (pop up)	
Normal	Off	Off	Off	· Automatic regeneration
Soot low	On	Off	Off	· Push DPF switch to OFF position if DPF switch is in inhibit position. · Engine power may be reduced automatically (soot medium)
Soot midium	Blink	Off	Off	
Soot high	On	On	Off	· Engine power and speed will be reduced automatically · Initiate a manual regeneration
Stop	On	Off	On	· Stop the engine immediatary. · Please contact your Hyundai service center or local dealer.

※ Manual regeneration method of DPF

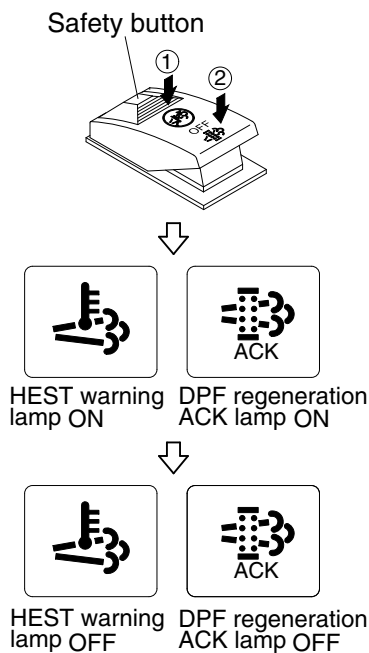

559A3CD143

※ Manual regeneration applies if the machine is in a fireproof area and there is no plan to turn off the machine during the regeneration.

- ① Stop and park the machine.
- ② The accel dial to the lowest position and operate the engine in idling.
- ③ Pull the safety button and push the switch to position ② to initiate the manual regeneration of DPF.

※ Refer to the page 4-58 for the switch operation.

※ The engine speed may increase gradually to high idle rpm and DPF regeneration begins and it will take approximately 25~30 minutes.

- ④ When the manual regeneration starts, the DPF warning lamp turns OFF and the regeneration acknowledge lamp and HEST warning lamp will light ON during the regeneration function is operating.
- ⑤ The regeneration acknowledge lamp and HEST warning lamp will light OFF when the regeneration function is completed.

(11) HEST (High exhaust system temperature) warning lamp

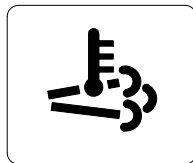

2609A3CD21

- ① This warning lamp indicates, when illuminated, that exhaust temperatures are high due to regeneration of the DPF.
- ② The lamp will also illuminate during a manual regeneration.
- ③ When this lamp is illuminated, be sure the exhaust pipe outlet is not directed at any surface or material that can melt, burn, or explode.

▲ When this lamp is illuminated, the exhaust gas temperature could reach 600°C [1112°F], which is hot enough to ignite or melt common materials, and to burn people.

※ The lamp does not signify the need for any kind of equipment or engine service; It merely alerts the equipment operator to high exhaust temperatures. It will be common for the lamp to illuminate on and off during normal equipment operation as the engine completes regeneration.

(12) Emission system fail warning lamp

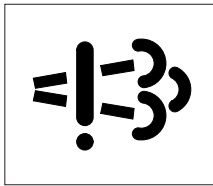

300A3CD15

- ① This warning lamp indicates there are faults related to the emission system.
 - ② The lamp lights ON when each of the below warnings is happened.
 - a. The EGR valve malfunctions.
 - b. Electrical malfunction of the EGR control sensors. (disconnection, short)
 - c. Tampering with the EGR control sensors.
 - ③ This warning lamp can be shown together with DPF warning lamp or engine fail lamp or engine stop warning lamp when diagnosis DPF systems.
- ※ Please contact your Hyundai service center or local dealer.

(13) DPF regeneration inhibit warning lamp

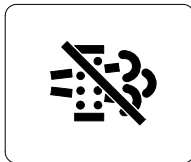

2609A3CD20

- ① This warning lamp indicates, when illuminated, the DPF switch is pushed inhibit position, therefore automatic and manual regeneration can not occur.
- ※ Refer to the page 4-58 for the DPF switch.

(14) DPF regeneration acknowledge warning lamp

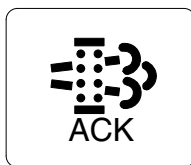

559A3CD10

- ① This warning lamp lights ON stationary regeneration is in process.
- ② This warning lamp lights ON, when stationary regeneration is in process after DPF regeneration request switch is pressed and hold for more than 3 seconds.
- ③ This warning lamp lights flash when stationary regeneration standby or regeneration interlock switch is in "regeneration permitted (interlock enabled) status.
- ④ This warning lamp lights flash while stationary regeneration standby or back mode, when DPF regeneration inhibit switch in "Regeneration permitted" status and regeneration interlock switch is in regeneration permitted status.

(15) Stop engine warning lamp

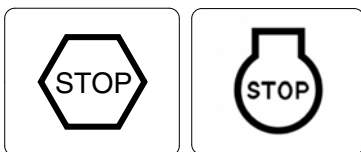

- ① If the lamp lights ON, stop the engine immediately and check the engine.
 - ② Check the fault codes on the monitor.
- ※ Please contact your Hyundai service center or local dealer.

5) PILOT LAMPS

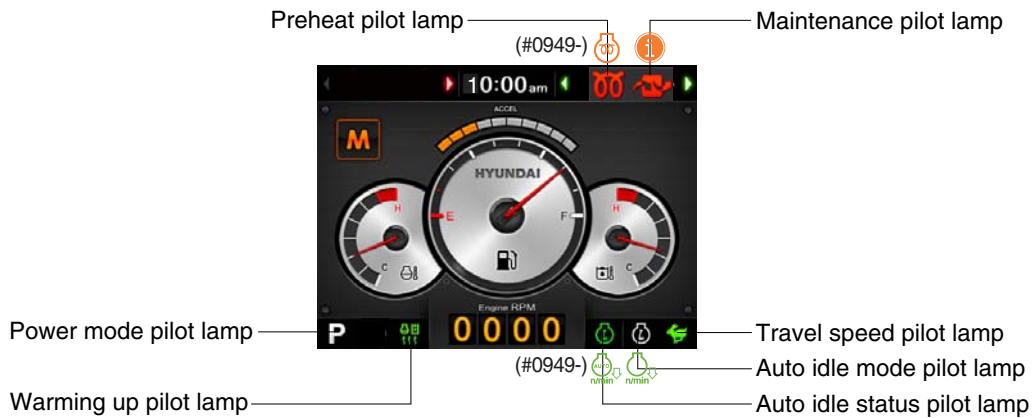

559A3CD02E

※ When the pilot lamps light ON more than 3, you can check all lamps with next page button (◀, ▶).

(1) Mode pilot lamps

No	Mode	Pilot lamp	Selected mode
1	Power mode		Heavy duty power work mode
			Standard power mode
2	Travel mode		Low speed traveling
			High speed traveling
3	Auto idle mode		Auto idle status
			Auto idle mode

(2) Preheat pilot lamp

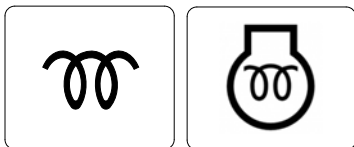

55I3CD39

- ① Turning the start key switch ON position starts preheating in cold weather.
- ② Start the engine after this lamp is OFF.

(3) Warming up pilot lamp

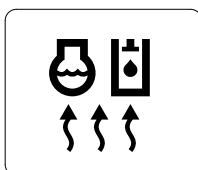

21093CD40

- ① This lamp is turned ON when the coolant temperature is below 30°C (86°F).
- ② The automatic warming up is cancelled when the engine coolant temperature is above 30°C, or when 10 minutes have passed since starting the engine.

(4) Auto idle status/ mode pilot lamp

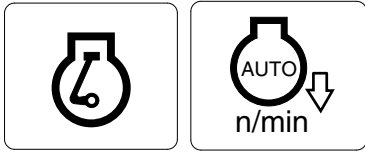

- ① The auto idle pilot lamp will be ON when the idle mode is selected.
- ② The auto idle status pilot lamp will be ON when all levers and pedals are at neutral position, and the auto idle mode is selected.

(5) Maintenance pilot lamp

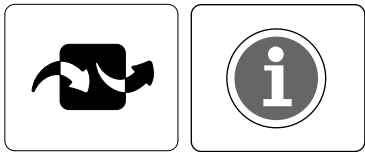

- ① This lamp will be ON when the consuming parts are needed to change or replace. It means that the change or replacement interval of the consuming parts remains below 30 hours.
- ② Check the message in maintenance information of main menu. Also, this lamp lights ON for 3 minutes when the start switch is ON position.

※ Refer to the page 4-19.

6) SWITCHES



559A3CD47

※ When the switches are selected, the pilot lamps are displayed on the LCD. Refer to the page 4-11 for details.

(1) Power mode switch

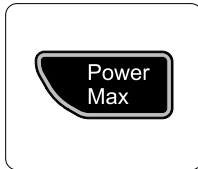

559A3CD25

- ① This switch is to select the machine power mode and selected power mode pilot lamp is displayed on the pilot lamp position.
 - P : Heavy duty power work.
 - S : Standard power work.
- ② The pilot lamp changes S → P → S in order.

(2) Select switch

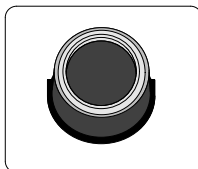

55I3CD50C

- ① This switch is used to select or change the menu and input value.
- ② Knob push
 - Long (over 2 sec) : Return to the operation screen
 - Medium (0.5~2 sec) : Return to the previous screen
 - Short (below 0.5 sec) : Select menu
- ③ Knob rotation

This knob changes menu and input value.

 - Right turning : Down direction / Increase input value
 - Left turning : Up direction / Decreased input value

(3) Auto idle/ buzzer stop switch

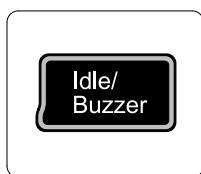



559A3CD50D

- ① This switch is used to activate or cancel the auto idle function.
※ **Refer to the page 4-12 for details.**
- ② The buzzer sounds when the machine has a problem.
In this case, push this switch and buzzer stops, but the warning lamp blinks until the problem is cleared.

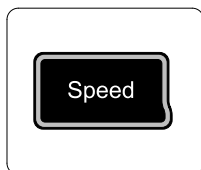
(4) Travel speed control switch



55I33CD50B

- ① This switch is used to select the travel speed alternatively.
 -  : Low speed
 -  : High speed

(5) Escape/ Camera switch

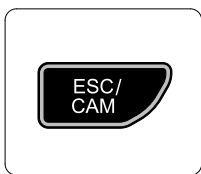

559A3CD50E

- ① This switch is used to return to the previous menu or parent menu.
- ② In the operation screen, pushing this switch will display the view of the camera on the machine (if equipped).
Please refer to page 4-23 for the camera.
- ③ If the camera is not installed, this switch is used only ESC function.

7) MAIN MENU

· Operation screen



559A3CD32A



559A3CD32B



559A3CD32C



Main menu screen



559A3CD32D





Sub menu screen



559A3CD32E

※ Please refer to select switch, page 4-13 for selection and change of menu and input value.

(1) Structure

No	Main menu	Sub menu	Description
1	 Monitoring 5513CD51A	Active fault - Machine Active fault - Engine Logged fault - Machine Logged fault - Engine Monitoring (Analog) Monitoring (Digital) - Input Monitoring (Digital) - Output	MCU ECU MCU ECU Machine information Switch status Output status
2	 Management 5513CD51B	ESL mode setting Change password Maintenance information Machine Information A/S phone number Service menu	ESL mode setting Password change Replacement, Change interval oils and filters Cluster, MCU, Engine, Machine A/S phone number, A/S phone number change Delete logged faults, Software download, Operating hour, power shift
3	 Display 5513CD51C	Clock Screen type Brightness setting Unit setting Language Calibration	Clock A type, B type, C type Manual, Auto Temperature, Pressure 12 language Calibrating the touch screen
4	 Utilities 5513CD51D	Camera setting Mode Video	Number of active, Display order, Camera No. Operation mode select Play music and video file

(2) Monitoring

① Active fault - Machine



559A3CD50A

- The active faults of the MCU can be checked by this menu.

② Active fault - Engine



559A3CD50C

- The active faults of engine ECU can be checked by this menu.

③ Logged fault - Machine/ Engine



559A3CD50A

- The logged faults of the MCU or engine ECU can be checked by this menu.
- Only for the service person.

④ Monitoring (Analog)



559A3CD52A

- The machine status such as the engine rpm, oil temperature, voltage and pressure etc. can be checked by this menu.

⑤ Monitoring (Digital) - Input



- The switch status can be confirmed by this menu.
- The activated switches are blue light ON.

⑥ Monitoring (Digital) - Output



- The output status can be confirmed by this menu.
- The output pilot lamps are blue light ON.

(3) Management

① ESL mode setting



ESL mode setting

- ESL : Engine Starting Limit
- ESL mode is designed to be a theft deterrent or will prevent the unauthorized operation of the machine.
- If the ESL mode was selected Enable, the password will be required when the start switch is turned ON.
- **Disable** : Not used ESL function
- **Enable (always)** : The password is required whenever the operator starts engine.
- **Enable (Interval)**: The password is required when the operator starts engine first.
But the operator can restart the engine within the interval time without inputting the password.
The interval time can be set maximum 2 days.

※ Default password : 00000

※ Password length : 5~10 digit

② Change password

- The password is 5~10 digits.

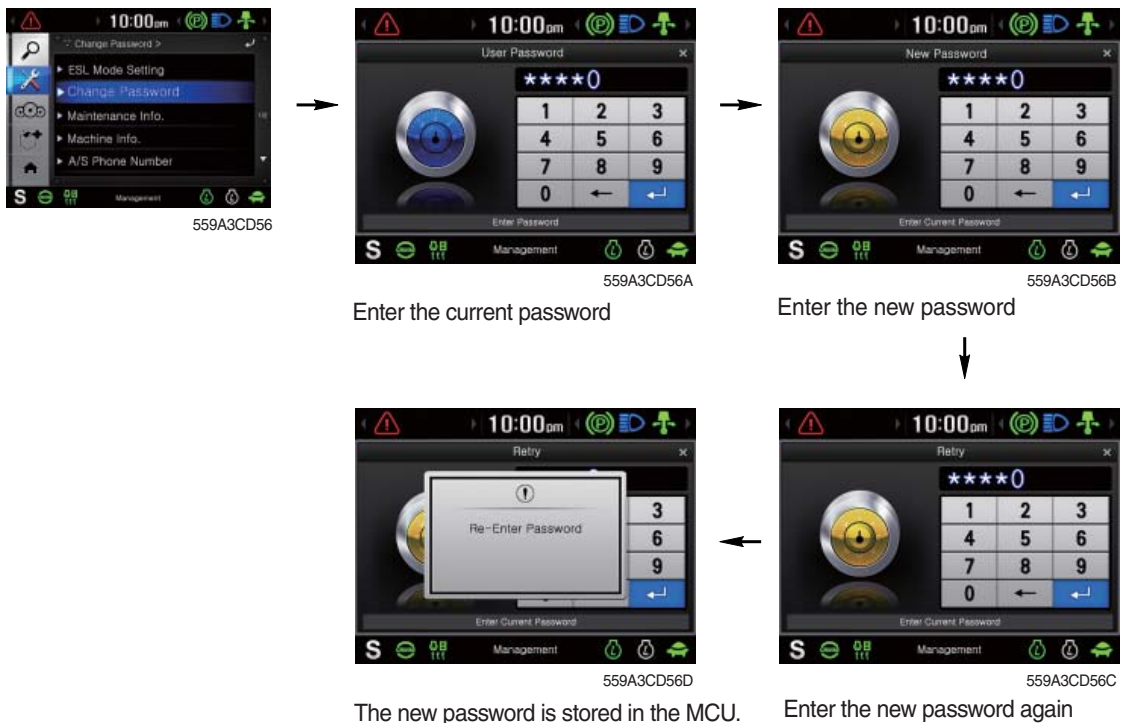

③ Maintenance information



- Elapse : Maintenance elapsed time.
- Interval : The change or replace interval can be changed in the unit of 50 hours.
- History-Hour : Maintenance replacement history.
- Replacement : The elapsed time will be reset to zero (0).
- **Change or relpace interval**

No	Item	Interval
1	Engine oil	500
2	Final gear oil	1000
3	Swing gear oil	1000
4	Hydraulic oil	5000
5	Pilot line filter	1000
6	Hydraulic oil return filter	1000
7	Engine oil filter	500
8	Fuel filter	500
9	Pre-filter	500
10	Hydraulic tank breather	250
11	Air cleaner	500
12	Radiator coolant	2000
13	Swing gear pinion grease	1000

④ Machine Information

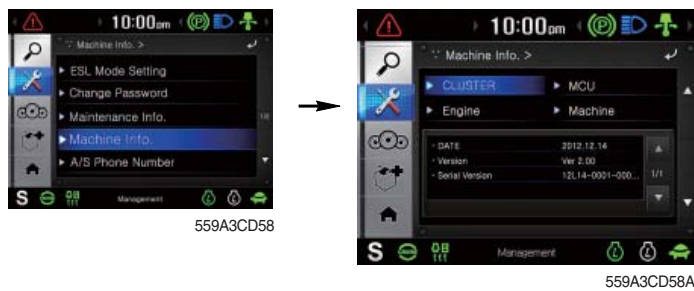

- This can confirm the identification of the cluster, MCU, engine and machine.

⑤ A/S phone number



- The A/S phone number can be checked and changed.

⑥ Service menu



- Delete logged fault : Logged faults of MCU or engine ECU can be deleted.
- S/W download : Update and display software about operating system, application, image and font.
- Operating hours : Operating hours since the machine line out can be checked.
- Power shift : Set power shift mode (standard/option)

(4) Display

① Clock



- The first line's three spots "****-**-**" represent Year/Month/Day each.
- The second line shows the current time. (AM, PM/0:00~12:59)

② Screen type



- The screen type (A,B,C) of the LCD can be selected by this menu.

③ Brightness setting calibration

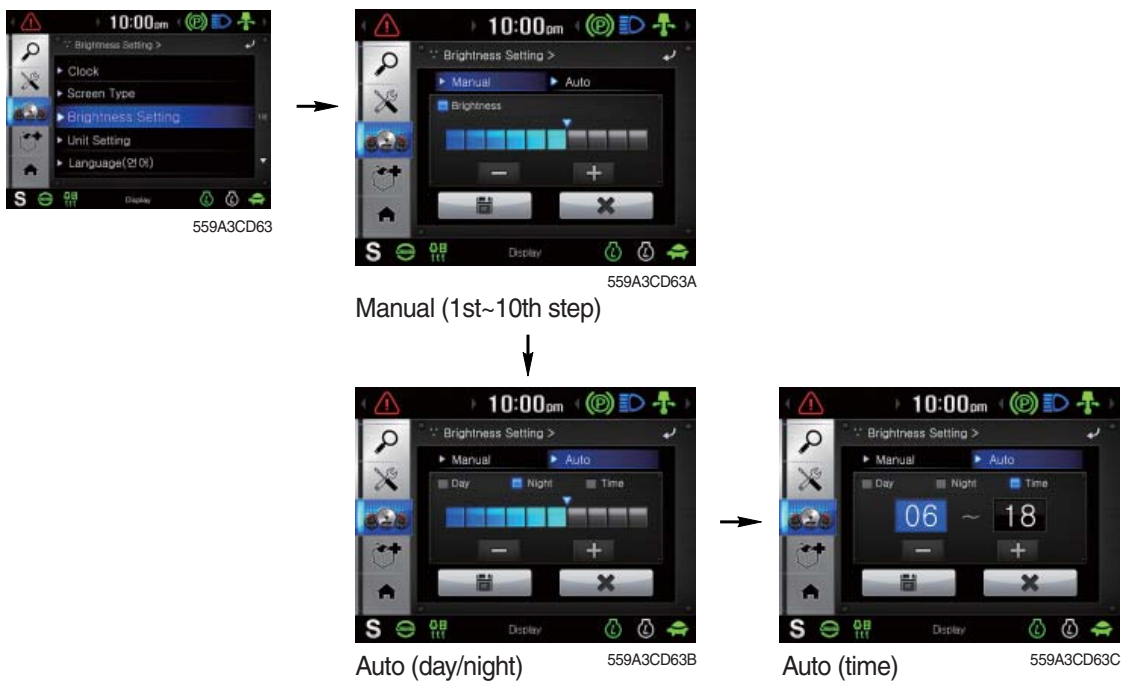

- If "Auto" is chosen, brightness for day and night can be differently set up. Also, users can define which day time interval. (Set day starting time and ending time)

④ Unit setting



- Temperature : °C ↔ °F
- Pressure : bar ↔ MPa ↔ kgf/cm² ↔ psi

⑤ Language



- User can select preferable language and all displays are changed the selected language.

⑥ Calibration

- When touch awareness goes wrong, this function use.
Fall in the next step if touches the middle point of cross with fingernail.
If touches total five points as follows, the setting is completed.

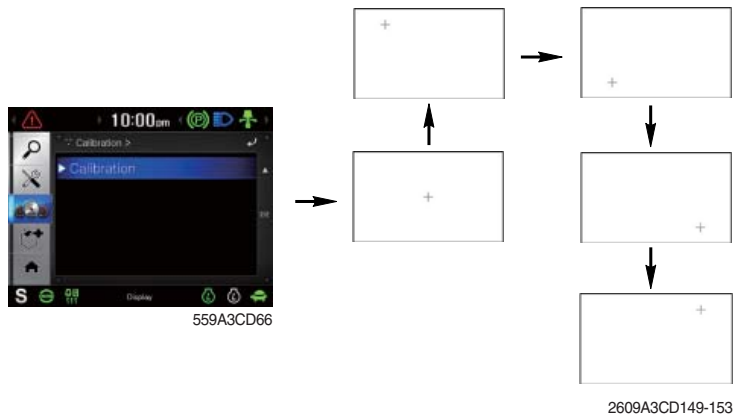

(5) Utilities

① Camera setting

- Three cameras can be installed on the machine and the display order can be set by this menu.
- If the camera was not equipped, this menu is not useful.



- In the operation screen, if the ESC/CAM switch is pushed, rear view camera display or stop.
- Turning the select switch in clockwise direction, the next ordered will be shown and in counter-clockwise direction, the previously ordered will be shown. Also, you can change camera channel using touch the screen.
- Push the select switch or touch the screen, the displayed screen will be enlargement.



② Mode



- When this cluster's buttons are not work, you can control using touch screen instead of these buttons.
- You can only control in this mode screen.

③ Video

- Play MP4 or codec file of external hard disk through USB port.
- The USB port is located under the cluster.



- Over 1100 engine rpm, the screen turns into the operation screen with MP4 or codec file playing for the safety.

No.	Function	Control	No.	Function	Control
1	Previous track	Power mode switch or touch	7	Sound volume	Speed switch or touch
2	Next track	Speed switch or touch	8	Stop	ESC/CAM button or touch
3	Play	Touch	9	File name	-
4	Pause	Touch	10	Current time/ Total time	-
5	Contents display	Touch	11	Current playing time	-
6	Mute	Touch	-	-	-

MONITORING SYSTEM ((machine serial No.: #1365~)

1) STRUCTURE

The cluster consists of LCD and switches as shown below. The LCD is to warn the operator in case of abnormal machine operation or conditions for the appropriate operation and inspection.

Also, The LCD is to set and display for modes, monitoring and utilities with the switches.

The switches or touch screen are to set the machine operation modes.

- ※ The cluster installed on this machine does not entirely guarantee the condition of the machine. Daily inspection should be performed according to chapter 6, Maintenance.
- ※ When the cluster provides a warning immediately check the problem, and perform the required action.



HX60A3CD100B

- ※ The warning lamp pops up, lights ON (on the left-top side) and the buzzer sounds when the machine has a problem.

The warning lamp lights ON until the problem is cleared. Refer to page 4-25 for details.

2) GAUGE

(1) Operation screen

When you first turn starting switch ON, the operation screen will appear.





- | | | |
|-----------------------------|--------------------|--------------|
| 1 Engine coolant temp gauge | 3 Fuel level gauge | 5 Accel dial |
| 2 Hydraulic oil temp gauge | 4 Engine rpm | 6 Clinometer |

※ Operation screen type can be set by the screen type menu of the display.
Refer to page 4-49 for details.

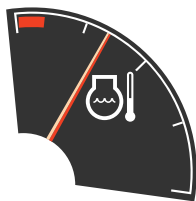
(2) Engine coolant temperature gauge





290F3CD53

- ① This gauge indicates the temperature of coolant.
 - Black range : 40-115°C (104-239°F)
 - Red range : Above 115°C (239°F)
 - ② If the indicator is in the red range or  lamp lights ON in red, turn OFF the engine and check the engine cooling system.
- ※ If the gauge indicates the red range or  lamp lights ON in red even though the machine is on the normal condition, check the electric device as that can be caused by the poor connection of electricity or sensor.

(3) Hydraulic oil temperature gauge





290F3CD54

- ① This gauge indicates the temperature of hydraulic oil.
 - Black range : 40-105°C (104-221°F)
 - Red range : Above 105°C (221°F)
 - ② If the indicator is in the red range or  lamp lights ON in red, reduce the load on the system. If the gauge stays in the red range, stop the machine and check the cause of the problem.
- ※ If the gauge indicates the red range or  lamp lights ON in red even though the machine is on the normal condition, check the electric device as that can be caused by the poor connection of electricity or sensor.

(4) Fuel level gauge



HX60A3CD55A

- ① This gauge indicates the amount of fuel in the fuel tank.
- ② Fill the fuel when the red range, or  lamp lights ON in red.
- ※ If the gauge indicates the red range or  lamp lights ON in red even though the machine is on the normal condition, check the electric device as that can be caused by the poor connection of electricity or sensor.

(5) Engine rpm display

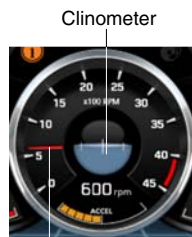

Engine rpm

HX60A3CD105K

- ① This displays the engine speed.

(6) Accel dial display



290F3CD59

- ① This displays acceleration dial level from 0 to 10 step.

3) COMMUNICATION ERROR AND LOW VOLTAGE WARNING POP-UP

(1) Communication error pop-up



HX60A3CD107A

- ① Cluster displays this communication error pop-up when it has communication error with MCU.
- ② Communication error pop-up displays at operation screen only. Just buzzer alarm at the other screen.
- ③ If communication with MCU become normal state, it will disappear automatically.

(2) Low voltage warning pop-up



HX60A3CD108

- ① Cluster displays this low voltage warning pop-up when the battery voltage is low.
- ② Low voltage warning pop-up displays at operation screen only. Just buzzer alarm at the other screen.
- ③ This pop-up will disappear with using touch screen or buzzer stop switch. While the battery voltage is low, buzzer sounds every minute.
- ④ When the battery voltage is higher than 11.5 V, the pop-up off.

4) WARNING LAMPS

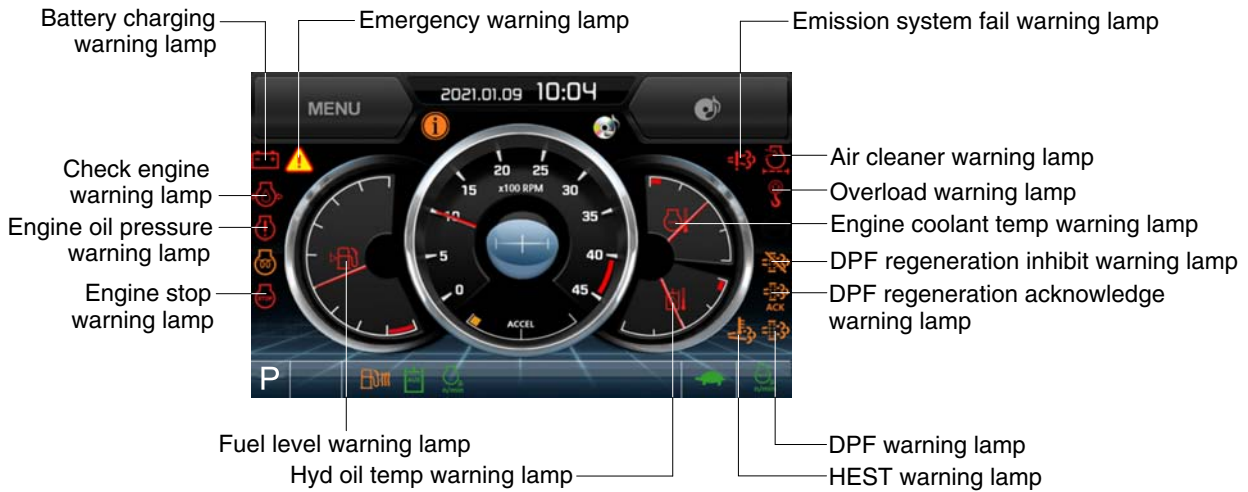



HX60A3CD109C

- ※ Each warning lamp on the left-top of the LCD pops up on the center of LCD and the buzzer sounds when the each warning is happened. The pop-up warning lamp moves to the original position and lights ON when the buzzer stop switch is pushed or the pop-up is touched. And the buzzer stops. Refer to page 4-36 for the switch.
- ※ When the warning lamps light ON more than 4, you can check all lamps with next page button (◀, ▶) near the warning lamps.

(1) Engine coolant temperature warning lamp





290F3CD61

- ① The  lamp pops up on the center of LCD and the buzzer sounds when the engine coolant temperature is over 115°C or more.
- ② The pop-up  lamp moves to the original position and lights ON when the buzzer stop switch is pushed or pop-up is touched. Also, the buzzer stops and  lamp keeps ON.
- ③ Check the cooling system when the lamp keeps ON.

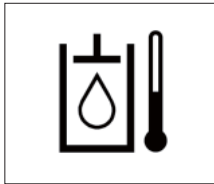
(2) Hydraulic oil temperature warning lamp



290F3CD62

- ① The  lamp pops up on the center of LCD and the buzzer sounds when the hydraulic oil temperature is over 105°C or more.
- ② The pop-up  lamp moves to the original position and lights ON when the buzzer stop switch is pushed or pop-up is touched. Also, the buzzer stops and  lamp keeps ON.
- ③ Check the hydraulic oil level and hydraulic oil cooling system.

(3) Fuel level warning lamp

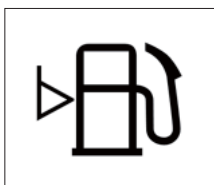

290F3CD63

- ① This warning lamp lights ON and the buzzer sounds when the level of fuel is below 10%.
- ② Fill the fuel immediately when the lamp is ON.

(4) Emergency warning lamp



290F3CD64

- ① This lamp pops up and the buzzer sounds when each of the below warnings are happened.
 - Engine coolant overheating (over 115°C)
 - Hydraulic oil overheating (over 105°C)
 - MCU input voltage abnormal
 - Accel dial circuit abnormal or open
- ※ **The pop-up warning lamp moves to the original position and lights ON when the buzzer stop switch is pushed or pop-up is touched. Also the buzzer stops. This is same as following warning lamps.**
- ② When this warning lamp lights ON, machine must be checked and serviced immediately.

(5) Engine oil pressure warning lamp

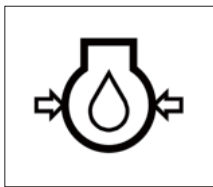

290F3CD65

- ① This lamp lights ON when the engine oil pressure is low.
- ② If the lamp lights ON, shut off the engine immediately. Check oil level.

(6) Check engine warning lamp



290F3CD66

- ① This lamp lights ON when the communication between MCU and engine ECM on the engine is abnormal, or if the cluster received any fault code from engine ECM.
- ② Check the communication line between them.
If the communication line is OK, then check the fault codes on the cluster.
- ③ Also, this lamp pops up when the level of DPF soot is high.
- ※ Refer to the page 4-30 for the DPF warning lamp.

(7) Battery charging warning lamp

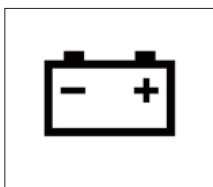

290F3CD67

- ① This lamp lights ON when the battery charging voltage is low.
- ② Check the battery charging circuit when this lamp is ON.

(8) Air cleaner warning lamp

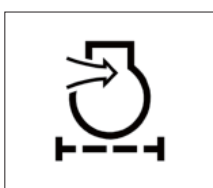

290F3CD68

- ① This lamp lights ON when the filter of air cleaner is clogged.
- ② Check the filter and clean or replace it.

(9) Overload warning lamp (option)

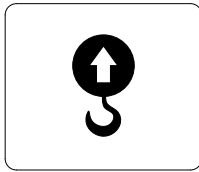

21093CD36

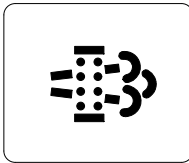

- ① When the machine is overload, the overload warning lamp lights ON during the overload switch is ON. (if equipped)
- ② Reduce the machine load.
Initiate a manual regeneration

(10) DPF (diesel particulate filter) warning lamp



2609A3CD19

- ① This warning lamp lights ON or OFF when the regeneration is needed.
 - ② This warning lamp lights ON while DPF regeneration inhibit switch is in "Regeneration inhibited" state, when stationary regeneration is permitted.
 - ③ This warning lamp lights ON during reset regeneration standby or in back up mode.
 - ④ This warning lamp lights flash during reset regeneration standby DPF regeneration inhibit switch is in "Regeneration inhibited" state.
- ※ Consequences of delaying regeneration
- Poor performance caused by increasing exhaust gas pressure.
 - Higher fuel consumption
 - Shorter filter lifetime

Condition	Warning lamp			Remedy
	DPF 	Check engine  (pop up)	Stop engine  (pop up)	
Normal	Off	Off	Off	· Automatic regeneration
Soot low	On	Off	Off	· Push DPF switch to OFF position if DPF switch is in inhibit position. (see 4-57 page) · Engine power may be reduced automatically (soot medium)
Soot midium	Blink	Off	Off	
Soot high	On	On	Off	· Engine power and speed will be reduced automatically · Initiate a manual regeneration
Stop	On	Off	On	· Stop the engine immediatary. · Please contact your Hyundai service center or local dealer.

(12) Emission system fail warning lamp

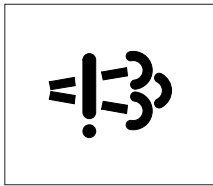

300A3CD15

- ① This warning lamp indicates there are faults related to the emission system.
 - ② The lamp lights ON when each of the below warnings is happened.
 - a. The EGR valve malfunctions.
 - b. Electrical malfunction of the EGR control sensors. (disconnection, short)
 - c. Tampering with the EGR control sensors.
 - ③ **This warning lamp can be shown together with DPF warning lamp or engine fail lamp or engine stop warning lamp when diagnosis DPF systems.**
- ※ **Please contact your Hyundai service center or local dealer.**

(13) DPF regeneration inhibit warning lamp

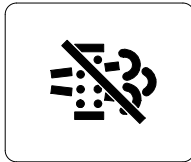

2609A3CD20

- ① This warning lamp indicates, when illuminated, the DPF switch is pushed inhibit position, therefore automatic and manual regeneration can not occur.
- ※ **Refer to the page 4-57 for the DPF switch.**

(14) DPF regeneration acknowledge warning lamp

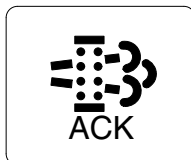

559A3CD10

- ① This warning lamp lights ON stationary regeneration is in process.
- ② This warning lamp lights ON, when stationary regeneration is in process after DPF regeneration request switch is pressed and hold for more than 3 seconds.
- ③ This warning lamp lights flash when stationary regeneration standby or regeneration interlock switch is in "regeneration permitted (interlock enabled) status.
- ④ This warning lamp lights flash while stationary regeneration standby or back mode, when DPF regeneration inhibit switch in "Regeneration permitted" status and regeneration interlock switch is in regeneration permitted status.

(15) Engine stop warning lamp



- ① If the lamp lights ON, stop the engine immediately and check the engine.
 - ② Check the fault codes on the monitor.
- ※ **Please contact your Hyundai service center or local dealer.**



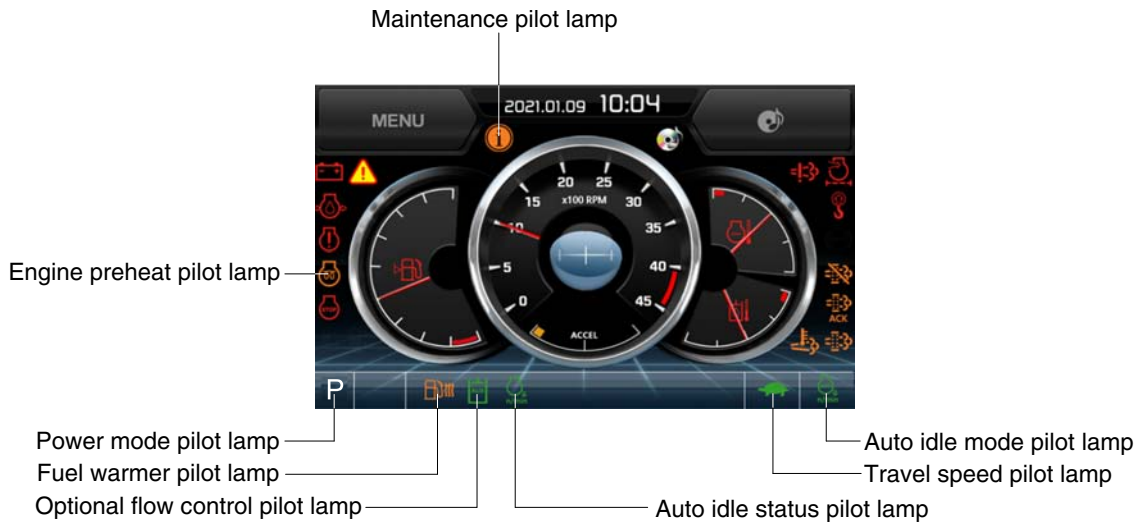



5) PILOT LAMPS



HX60A3CD112C

※ The left and the right movement buttons (◀ and ▶) are activated when nine indicator or more light, and touching the button shifts to the previous/next page. The buttons are not activated when eight indicators or less light.

(1) Mode pilot lamp

Sequence	Mode	Pilot lamp	Selected mode
1	Power mode		Heavy duty power work mode
			Standard power mode
2	Travel mode		Low speed traveling
			High speed traveling
3	Auto idle mode		Auto idle mode
			Auto idle status

(2) Engine preheat pilot lamp



290F3CD79

① Turning the start switch ON automatically starts preheating.

② Start the engine after this indicator turns off.

See Page 4-4.

(3) Warming up pilot lamp

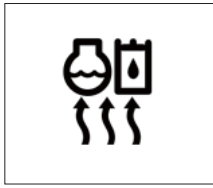

290F3CD80

- ① This lamp is turned ON when the coolant temperature is below 30°C (86°F).
- ② The automatic warming up is cancelled when the engine coolant temperature is above 30°C, or when 10 minutes have passed since starting the engine.

(4) Auto idle status/ mode pilot lamp

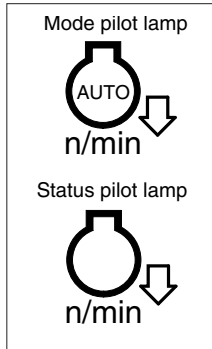

85A3CD106

- ① The auto idle mode pilot lamp will be ON when the idle mode is selected.
- ② The auto idle status pilot lamp will be ON when all levers and pedals are at neutral position, and the auto idle mode is selected.
- ③ One of the lever or pedal is operated, the status lamp will be OFF and the engine speed returns to the previous conditions.

(5) Maintenance pilot lamp



HX60A3CD116

- ① This lamp will be ON when the consuming parts are needed to change or replace. It means that the change or replacement interval of the consuming parts remains below 30 hours.
- ② Check the message in maintenance information of main menu. Also, this lamp lights ON for 3 minutes when the start switch is ON position.

※ Refer to the page 4-41.

(6) Fuel warmer pilot lamp

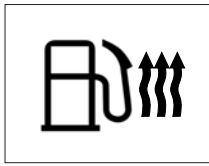

HX60A3CD111

- ① This lamp is turned ON when the coolant temperature is below 10°C (50°F) or the hydraulic oil temperature 20°C (68°F).
- ② The automatic fuel warming is cancelled when the engine coolant temperature is above 60°C, and the hydraulic oil temperature is above 45°C since the start switch was ON position.

(7) Optional flow control pilot lamp

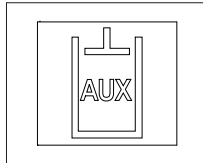

HW60A3CD48A

- ① The indicator lights when activating (performing) the optional flow control function.
- ※ **Refer to the Page 4-41.**

6) SWITCHES



HX60A3CD117D

※ Selecting the switch displays the indicator on LCD. See Page 4-32 for further information.

(1) Power mode switch

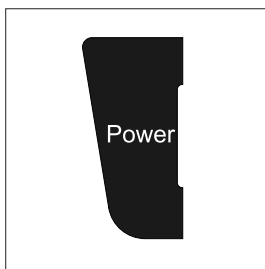

HX60A3CD118

- ① This switch selects the system power mode, and the selected power mode indicator is displayed on the indicator position.
 - P : High-load work
 - S : Standard load work
- ② The indicators shifts in the sequence of S → P → S.

(2) Select switch

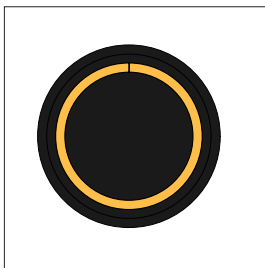

HX60A3CD119

- ① The switch is used for selecting or changing the menus and input values.
- ② Knob pressing
 - Pressing short (0.5 sec. or less) : Menu selecting
- ③ Knob turning
 - This knob is used for changing menus and input values :
 - Right turning : Increasing downward direction and input value
 - Left turning : Decreasing upward direction and input value

(3) Auto idle switch

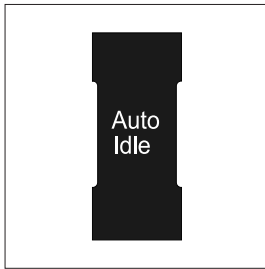

HX60A3CD120

① This switch is used for operating or canceling the auto idle function.

※ See Page 4-32 for further information.

(4) Buzzer stop switch



HX60A3CD121

① The buzzer sounds when the system fails.

In such a case, press the switch to stop the buzzer. The alarm indication is kept lit until trouble is resolved.

(5) Camera switch

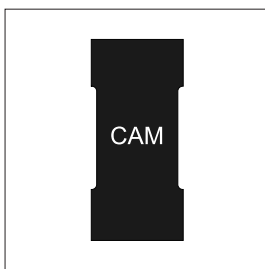

HX60A3CD122

① Pressing this switch on the operation screen of the main menu displays the area illuminated by the camera mounted on the system (if the camera is mounted).

See Page 4-51 for information of the camera.

(6) Escape switch

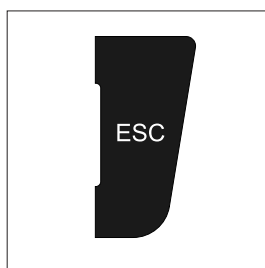

HX60A3CD123

① This switch is used for return to the previous or the next menu.

(7) Travel speed switch

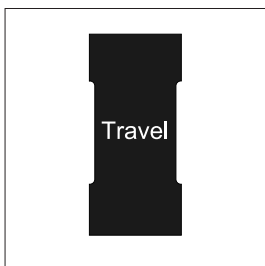

HX60A3CD104

① This switch is used for changing driving speed.

⚡ : High speed

🐢 : Low speed

※ Do not operated the driving speed switch during driving.

System stability may adversely be affected.

⚠ Rapid change of system stability may cause injury or death of driver.

7) MAIN MENU

Main menu screen



HX60A3CD124A

Tap

or

Sub menu screen

Press



Press







HX60A3CD125A

※ See “Selection Switch” on page 4-35 for further information on selection and change of the menus and input values.

※ Touching the main menu switch, or pressing the selection switch prompts the sub-menu screen.

(1) Structure

No.	Main menu	Sub-menu	Description
1	 Monitoring	Active fault Logged fault Delete logged fault Monitoring	List of active fault of system/engine List of logged fault of system/engine Deleting specifics of logged fault (system/engine) Monitoring (conditions of system, switch, and output)
2	 Management	Maintenance info. Aux flow setting ELS mode setting Machine information Contact Cluster update Service menu	Checking and initialization of service Interval of oil and filters Optional attachment setting ELS mode setting/user password changing Information of cluster, MCU, engine system Display and change of contact information for after-sales services System and application updating Power shift, Operation hours, Main gauge type, Display RPM, DPF filter exchange, AVCU setting, Adding language
3	 Display	Clock adjust Brightness setting Unit setting Language selection	Current time setting Manual, auto Temperature, Distance, Pressure, Flow, Volumn 24 languages
4	 Utilities	Entertainment Camera setting Clinometer setting Emergency mode	Video/music file playing Setup of number of active cameras, display sequences, and camera numbers Initializing slope sensor Back-up switch for failed cluster switch

(2) Monitoring

① Active fault - system

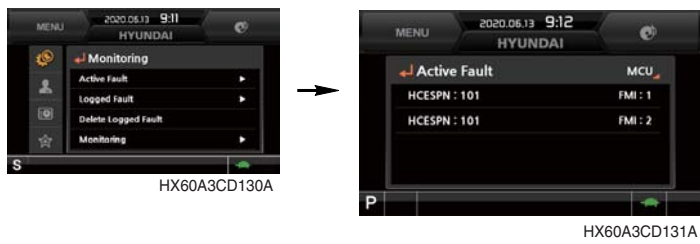

- You may use this menu to check active fault of MCU.

② Active fault - engine

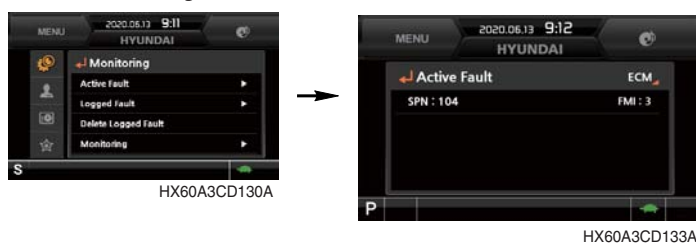

- You may use this menu to check active fault of engine ECM.

③ Logged fault - system/engine



- You may use this menu to check fault logged on system MCU or engine ECM.
- The menu is accessible by maintenance engineer only.

④ Delete logged fault

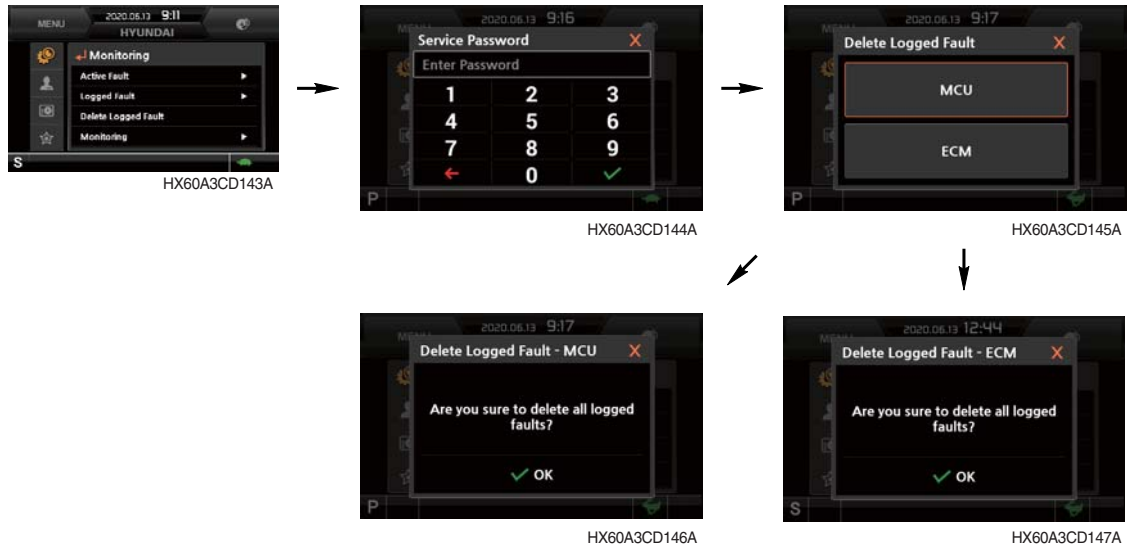

- Delete logged fault: You are allowed to delete fault logged on system MCU or engine ECM. (Deletion can be deleted only while the engine is kept stopped.)

⑤ Monitoring (system conditions)

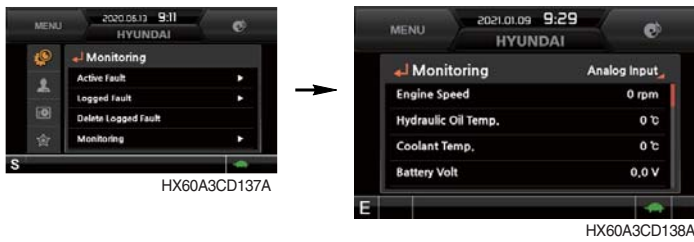

- You may use this menu to check the system conditions such as engine rotation rate, oil temperature, voltage and pressure.

⑥ Monitoring (switch conditions)



- You may use this menu to check digital switch information of the system.
- The operation switch lights blue.

⑦ Monitoring (output conditions)

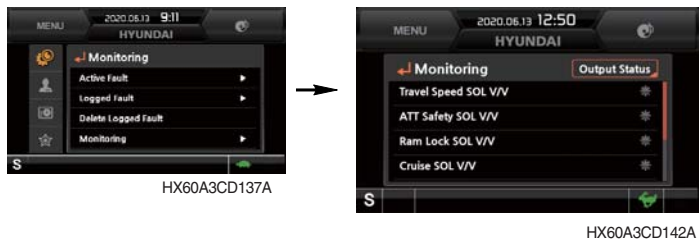

- You may use this menu to check digital output information of the system.
- Output lights blue.

(3) Management

① Maintenance info.



- Elapsed: Time elapsed since inspection and maintenance is displayed.
- Change interval: You are allowed of changing exchange cycle in 50 hours.
- History-Hourmeter: History of inspection, maintenance and exchange is displayed.
- Replacement: Elapsed time is reset to zero.
- **Change or replace interval**

No	Item	Interval
1	Engine oil	500
2	Final gear oil	1000
3	Hydraulic oil	5000
4	Pilot line filter	1000
5	Hydraulic oil return filter	1000
6	Engine oil filter	500
7	Fuel filter	500
8	Pre-filter	500
9	Hydraulic tank breather	250
10	Air cleaner	500
11	Radiator coolant	2000

② Aux flow setting

a. Optional attachment setup



- Setup up to three optional attachments.

- Rotary grapple (4-way)
- Grapple (2-way)
- Auger (2-way)

※ Each option attachment operating in one of two user modes (Type A and B)

b. Proportional flow control setting

You may use this menu to set the values of individual option attachments.

a) Rotary setup



- Rotary selecting RCV, button, and flow setup.

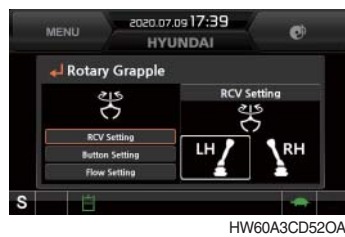

- RCV setup
 - It is possible to set operating RCV for rotary operation to LH or RH .
 - Selecting rotary RCV to LH automatically sets grapple RCV to RH.



- Button setup (rotating clockwise)
 - Selecting clockwise rotating direction to LH automatically sets counterclockwise rotating direction to RH.



- Flow setup
 - You may set flow between Level 1 and 5.

b) Grapple setting

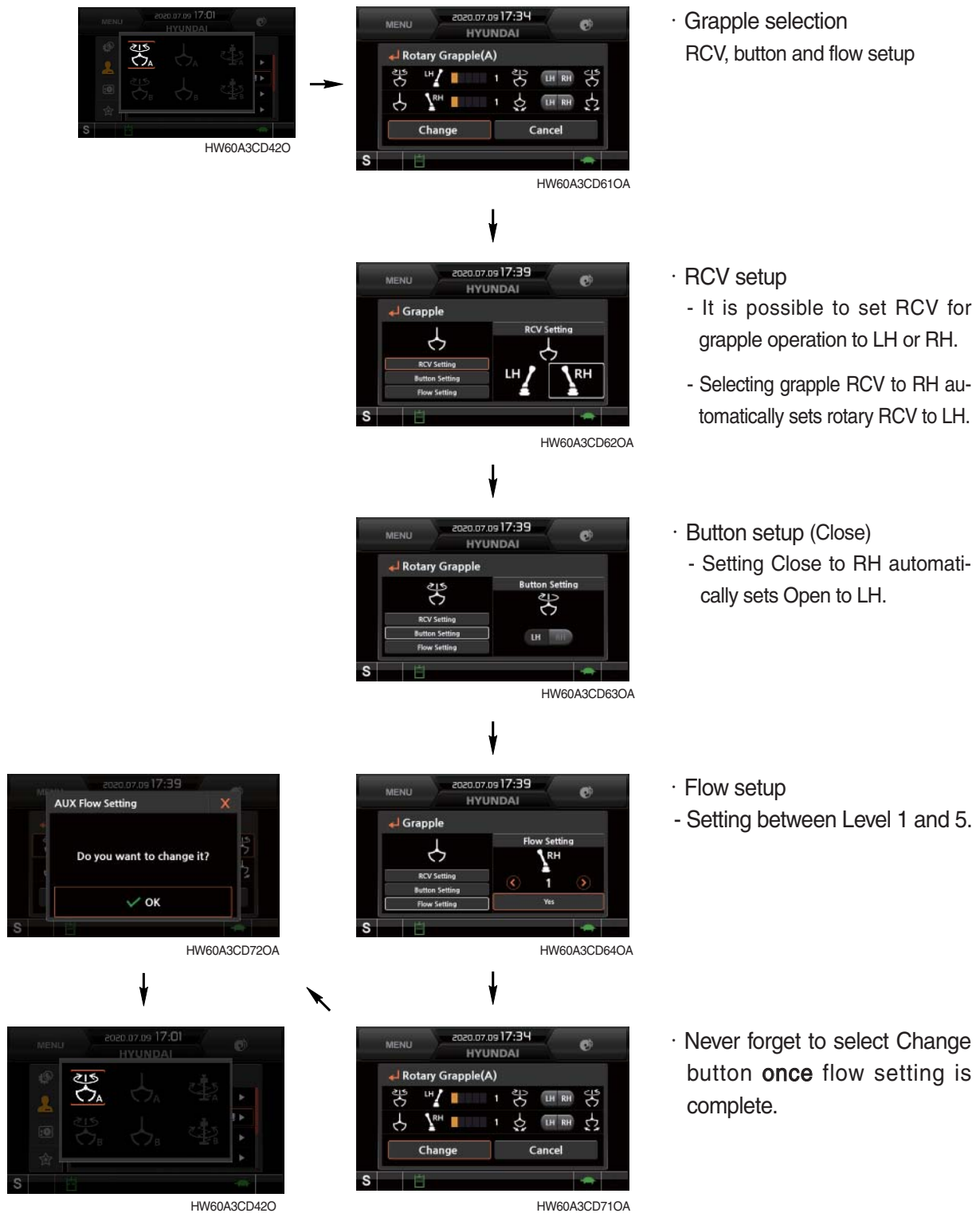

- ※ Saved setting is stored in each icon, and value finally stored becomes active.
- ※ You may use any stored values by pressing Icon button.
- ※ It is possible to perform two user's settings per attachment (A and B), and to store up to six values.
(Two for 4-way, four for 2-way)

c) Checking settings

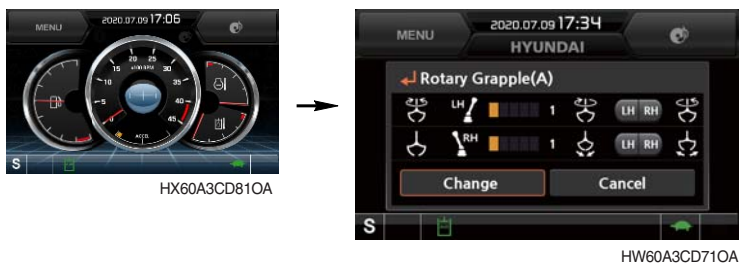

※ Operating optional attachment function activates the symbol  on the bottom of the main screen.

※ You are allowed of checking settings as follows in the course of Menu - Administrator Functions - Optional Attachment.

(a) Rotary setup

- Rotary RCV setup : LH
- Rotary flow level : 3
- CW direction control : LH
- CCW direction control : RH

(b) Grapple setup

- Grapple RCV setup : RH
- Grapple flow level : 3
- Open control : LH
- Close contro l: RH

③ ESL mode setting



- The ESL mode setting is designed to prevent theft and unauthorized operation of the system.
 - When selecting the ESL mode setting to continuous operation, password should be entered when turning the Start button ON.
 - Disabled : The ESL mode setting function does not operate.
- Continuous operation : Password should be entered whenever operator starts the engine.
- Enable(interval): Password should be entered when operator starts the engine first. It is not required to enter the password until restart within specified time.
- You may set the specified time up to two days.

※ Default password : 00000

※ Length of password : 5-10 digits

④ Changing password

- The length of the password is between 5 and 10 digits.



HX60A3CD151A

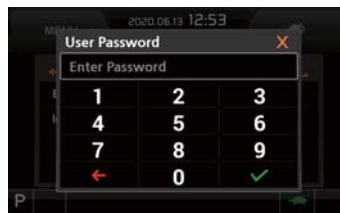

HX60A3CD149A

Entering current password



HX60A3CD153A

Selecting Change Password

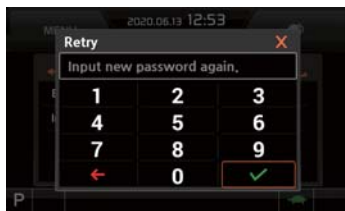

HX60A3CD156A

Storing new password in MCU

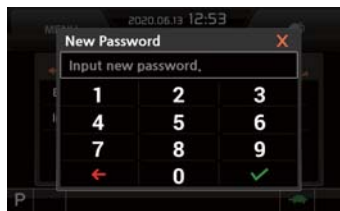

HX60A3CD155A

Entering new password again

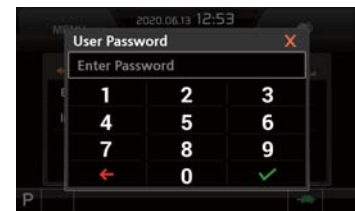

HX60A3CD149A

Entering new password

⑤ Machine information



HX60A3CD160A



HX60A3CD161A



HX60A3CD162A

· On this screen, you may check information of the instrument panel, the system controller (MCU), the engine and the system.

⑥ Contact



HX60A3CD163A



HX60A3CD164A



HX60A3CD165A

· You may check or change the contact information for after-sales services.

⑦ Cluster update



HX60A3CD169A



HX60A3CD170A

Selecting Cluster Update



HX60A3CD149A

Entering user's password

- It is possible to update the cluster and CAN.
- ※ Do not turn power off while updating.

a. Application update



HX60A3CD172A

Selecting application items



HX60A3CD173A

Selecting files to update



HX60A3CD174A

Selecting OK



HX60A3CD176

Completed

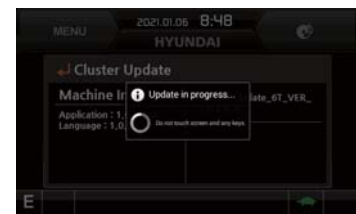

HX60A3CD175A

In progress

b. System update



HX60A3CD177A

Selecting system items



HX60A3CD173A

Selecting files to update



HX60A3CD174A

Selecting OK



HX60A3CD176

Completed



HX60A3CD175A

In progress

⑧ Service menu

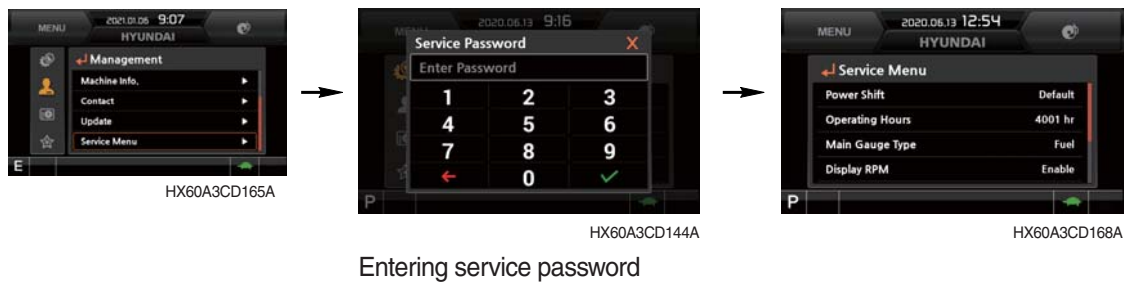

- Power shift : Set the power shift mode (default/option).
 - Operating hours : You may check operating hours of the system in individual modes after acceptance of the system.
 - Main gauge type : It is possible to display engine rotation rate or fuel level on the main gauge of the main screen.
 - Display RPM : It is possible to set display of numeric value of engine rotation rate on the main gauge of the main screen.
 - DPF filter exchange : You may initialize parameters relevant to DPF of engine ECU after cleaning the DPF filter.
 - AVCU setting : You may select Standard, 2-Way or 4-Way dependent upon the system options.
 - Adding language : It is possible to update language displayed on the cluster when it is required to correct language.
- ※ The service menu is accessible by maintenance engineer only. Do not attempt unauthorized adjustment.

(4) Display

① Clock adjust



HX60A3CD191A



HX60A3CD192A

- "****_**_**" on the first line indicates year/month/day.
- The second line indicates current time (00:00 - 12:59 am/pm)

② Brightness setting



HX60A3CD193A



Manual (Level 1 to 10) HX60A3CD194A



HX60A3CD195A

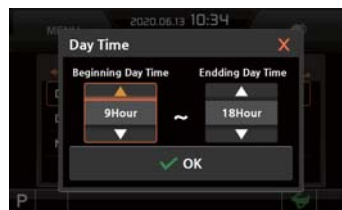

Auto (day/night) HX60A3CD197A



Auto (daytime) HX60A3CD196A

- Selecting "Auto" allows setting brightness different in day and night. It is also allowed to set hours in daytime. (Setting beginning day time and ending day time)

③ Unit setting

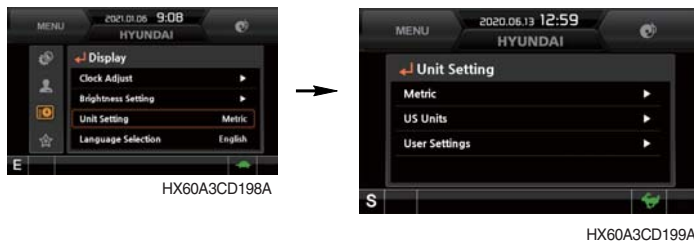

- Metric: Units are changed to metric units.
- U.S. units: Units are changed to U.S. units.
- User setting : Units are changed to user setting.

Item	Metric system	U.S. unit	User's setup
Temperature	°C	°F	°C, °F
Distance	km	mile	km, mile
Pressure	bar	Mpa	bar, Mpa, kgf/cm ² , psi
Flow	lpm	gpm	lpm, gpm
Volume	l	gal	l, gal

④ Language selection



- You may select your language (from 24 languages), and all the information is displayed in the selected language.

(5) Utilities

① Entertainment



- You may play MP4 or CODEC files of detachable hard disk through USB port.
- USB port is on the left of the instrument panel.
- When engine rotation rate exceeds 1100 rpm or higher, the screen is switched to the operation screen even while MP4 or CODEC file is played for safety. When engine rotation rate drops to 1100 rpm or lower, animation clip is played again.

⚠ Do not play animation clip while operating the system to prevent risks of accident.

② Camera setting



- You may install three cameras on the system, and set display sequence on this menu.
- If no camera is installed, this menu is disabled.
- When rotating Select switch clockwise, the screen of the next camera is displayed. When rotating the switch counterclockwise, the screen of the previous camera is displayed. You may also change the camera channel by touching the screen.
- You may display or hide the mini instrument panel by pressing Select switch or touching the screen.

(Mini instrument panel displayed → hidden → displayed)

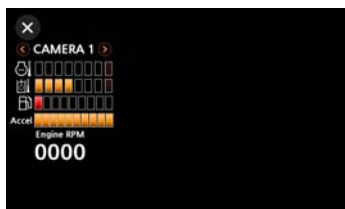

HX60A3CD204

- Pressing ESC switch or touching X icon on the screen terminates the camera mode.

③ Clinometer setting

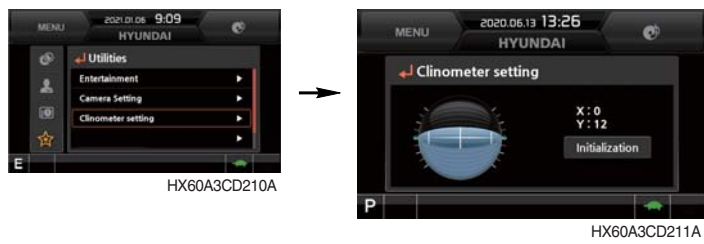

- Pressing “Default” when the system is kept on flat surface resets X and Y values to zero.
- You may check gradient of the system on the operating screen of the instrument panel.

④ Emergency mode



- When the switch or the acceleration dial of the monitor fails, the switch is displayed on LCD, and you are allowed to perform operation by touching the screen.
- Such operation is allowed only on this mode screen.

3. SWITCHES

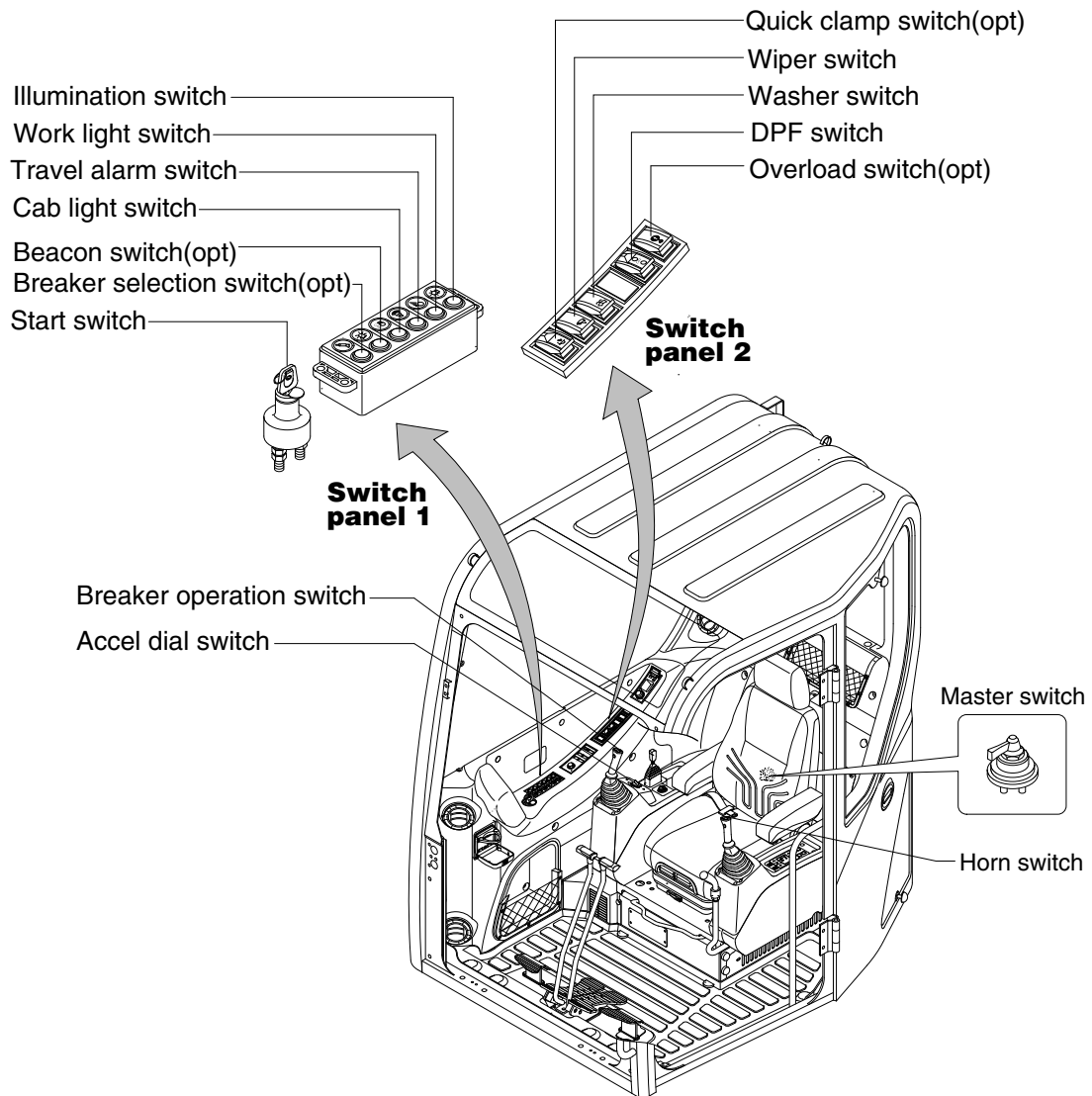

80CR9A3CD02

1) STARTING SWITCH

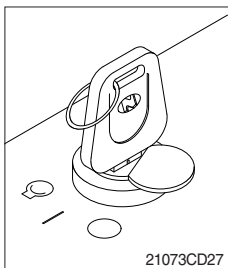

(1) There are three positions, OFF, ON and START.

- ○ (OFF) : None of electrical circuits activate.
- | (ON) : All the systems of machine operate.
- Ⓚ (START) : Use when starting the engine.

Release key immediately after starting.

※ **Key must be in the ON position with engine running to maintain electrical and hydraulic function and prevent serious machine damage.**

2) ACCEL DIAL

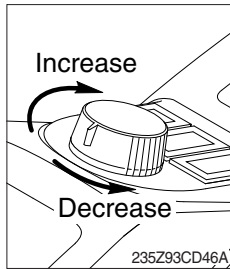

- (1) There are 10 dial setting.
- (2) Setting 1 is low idle and setting 10 is high idle.
 - By rotating the accel dial to right : Engine speed increased.
 - By rotating the accel dial to left : Engine speed decreased.

3) HEAD LIGHT SWITCH

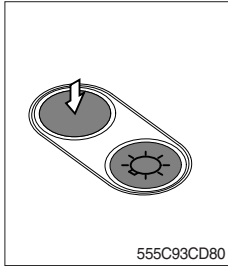

- (1) This switch is used to operate the head light.
 - Press the switch once, the head light comes ON and the pilot lamp ON.
 - Press the switch once more, the head light and pilot lamp turn off.

4) WORK LIGHT

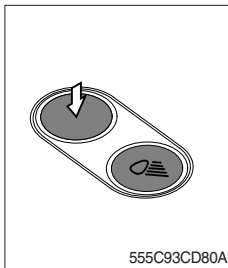

- (1) This switch is used to operate the work light.
 - Press the switch once, the work light comes ON and the pilot lamp ON.
 - Press the switch once more, the work light and pilot lamp turn off.

5) TRAVEL ALARM SWITCH

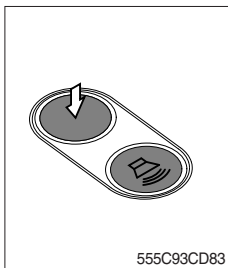

- (1) This switch is used to alarm surroundings when the machine travels to forward and backward.
- (2) On pressing this switch, the alarm operates only when the machine is traveling.

6) CAB LIGHT SWITCH

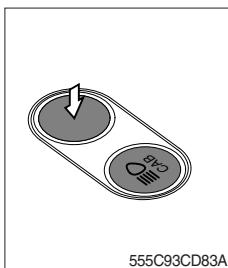

- (1) This switch turns on the cab light on the cab.

7) BEACON SWITCH (option)

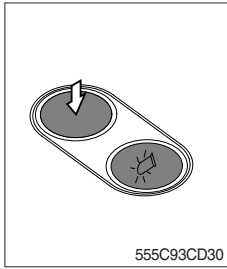

- (1) This switch turns ON the rotary light on the cab.
- (2) The below indicator lamp is turned ON when operating this switch.

8) BREAKER SELECTION SWITCH (option)

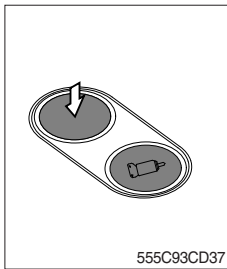

- (1) This switch is used to operate breaker.
- ※ **The breaker operates only when this switch is pressed.**
 - ※ **This switch applies to single action hydraulic attachment circuit.**

9) WIPER SWITCH

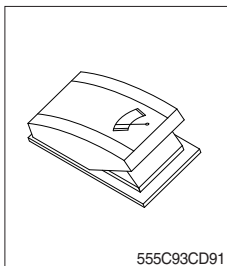

- (1) This switch is used to operate the wiper.
The wiper operates.
- ※ **Wiper motor doesn't operate with front sliding door open.**
 - ※ **If wiper does not operate with the switch in the ON position, turn the switch off immediately. Check the cause. If the switch remains ON, motor failure can result.**

10) WASHER SWITCH

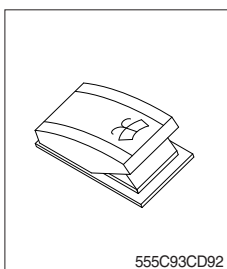

- (1) This switch is used to operate the washer.
 - The washer liquid is sprayed and the wiper is operated only while pressing this switch. If release the switch, return to the first position.

11) QUICK CLAMP SWITCH (option)

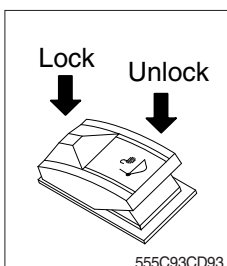

- (1) This switch is used to engage or disengage the moving hook on quick clamp.
- ※ **Refer to the operator's manual page 8-6 for details.**

12) OVERLOAD SWITCH (option)

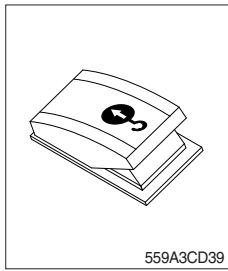

- (1) When this switch pressed ON position, buzzer makes sound and overload warning lamp comes ON in case that the machine is overload.
- (2) When it pressed OFF position, buzzer stops and warning lamp goes out.

13) MASTER SWITCH

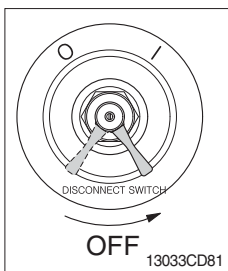

- (1) This switch is used to shut off the entire electrical system.
 - (2) I : The battery remains connected to the electrical system.
O : The battery is disconnected to the electrical system.
- ※ **Never turn the master switch to O (OFF) with the engine running. It could result in engine and electrical system damage.**

14) HORN SWITCH

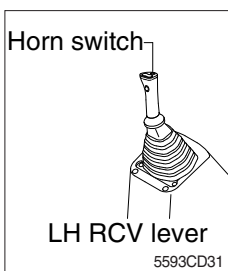

- (1) This switch is at the top of left side control lever.
On pressing, the horn sounds.

15) BREAKER AND 2-WAY OPERATION SWITCH

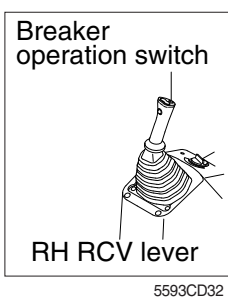

- (1) On pressing this switch, the breaker operates only when the breaker selection switch on the switch panel is selected.
- ※ **This switch applies to single action hydraulic attachment circuit.**

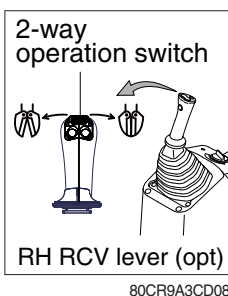

- (2) This switch operates the clamshell or shear.
- ※ **This switch applies to double action hydraulic attachment circuit.**

16) DPF (diesel particulate filter) SWITCH

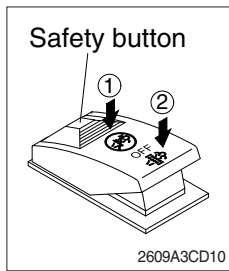

(1) This switch is used to select the regeneration function of the DPF.

(2) Inhibit position (①)

- ① The inhibit position disallows any automatic or manual regeneration of the DPF.
- ② This may be used by operator to prevent regeneration when the machine is operating in a hazardous environment concerned about high temperature.
- ③ It is strongly recommended that this position is only activated when high temperatures may cause a hazardous condition.

(3) OFF position

This position will initiate a automatic regeneration of the DPF.

(4) Manual regeneration position (②)

- ① This position will only initiate a manual regeneration of the DPF when the machine is in non-mission condition, engine must run at low idle speed and DPF soot levels are high enough to allow regeneration.
- ② HEST lamp will be illuminated during the entire regeneration.
- ※ **Refer to the page 4-9 for details.**
- ※ **This switch can be move to the manual regeneration position (②) only when the safety button is pulled to backward.**
- ※ **Also, this switch return to the OFF position when released the manual regeneration position (②).**

GROUP 3 ELECTRICAL CIRCUIT

· ELECTRICAL CIRCUIT (1/2)

- MACHINE SERIAL NO. : #1454

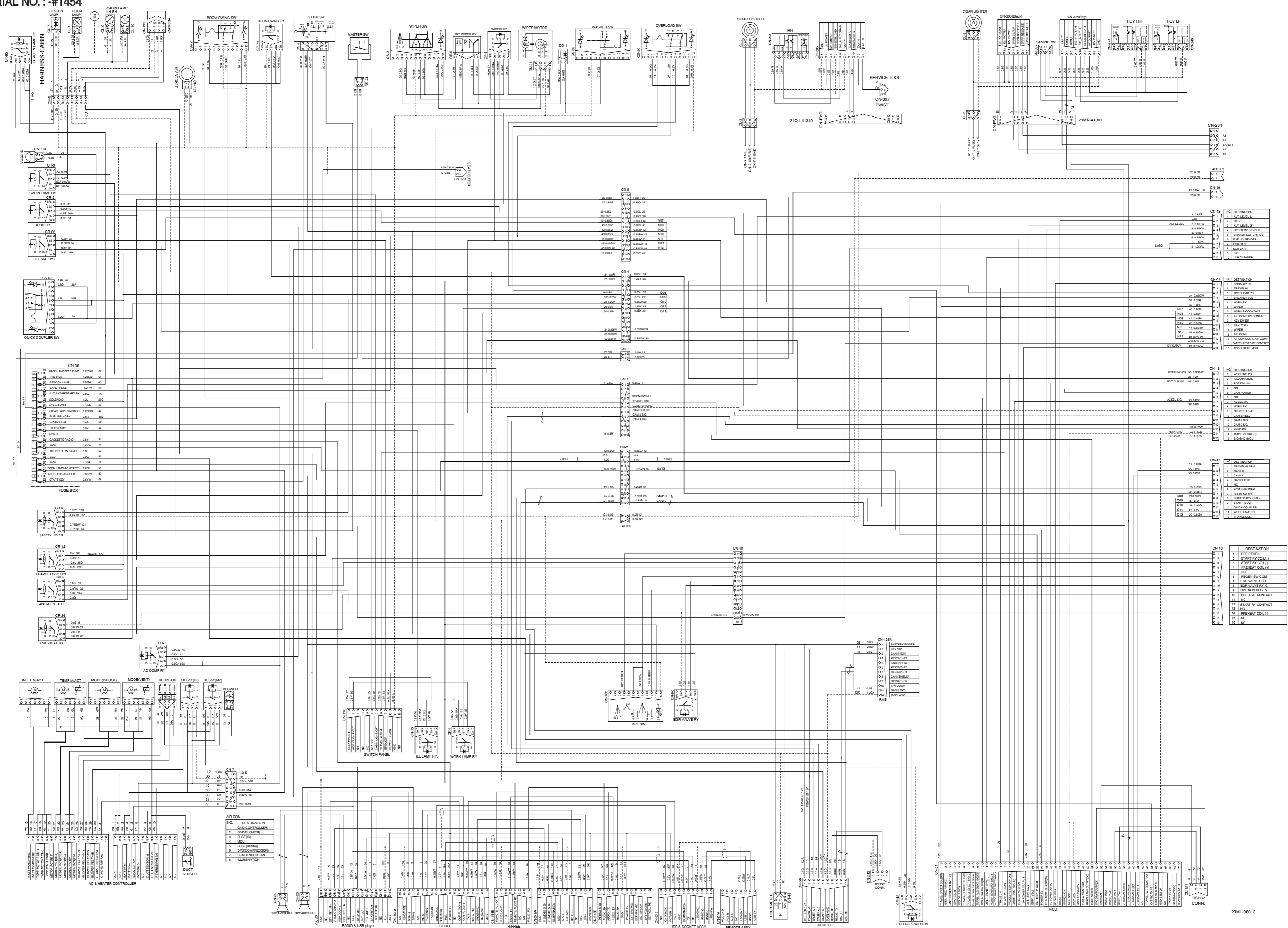

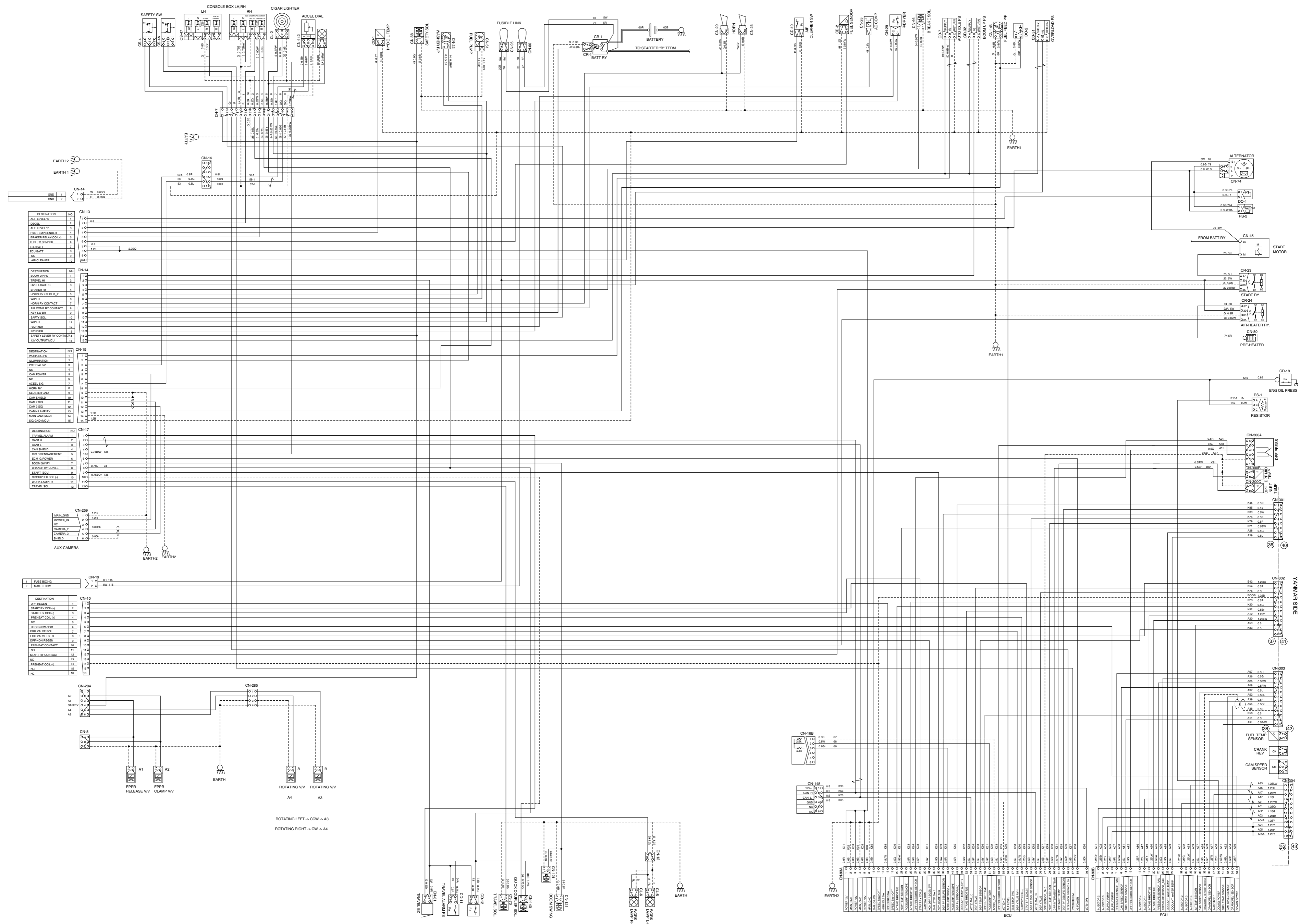

ELECTRICAL CIRCUIT (2/2)

- MACHINE SERIAL NO. : -#1454

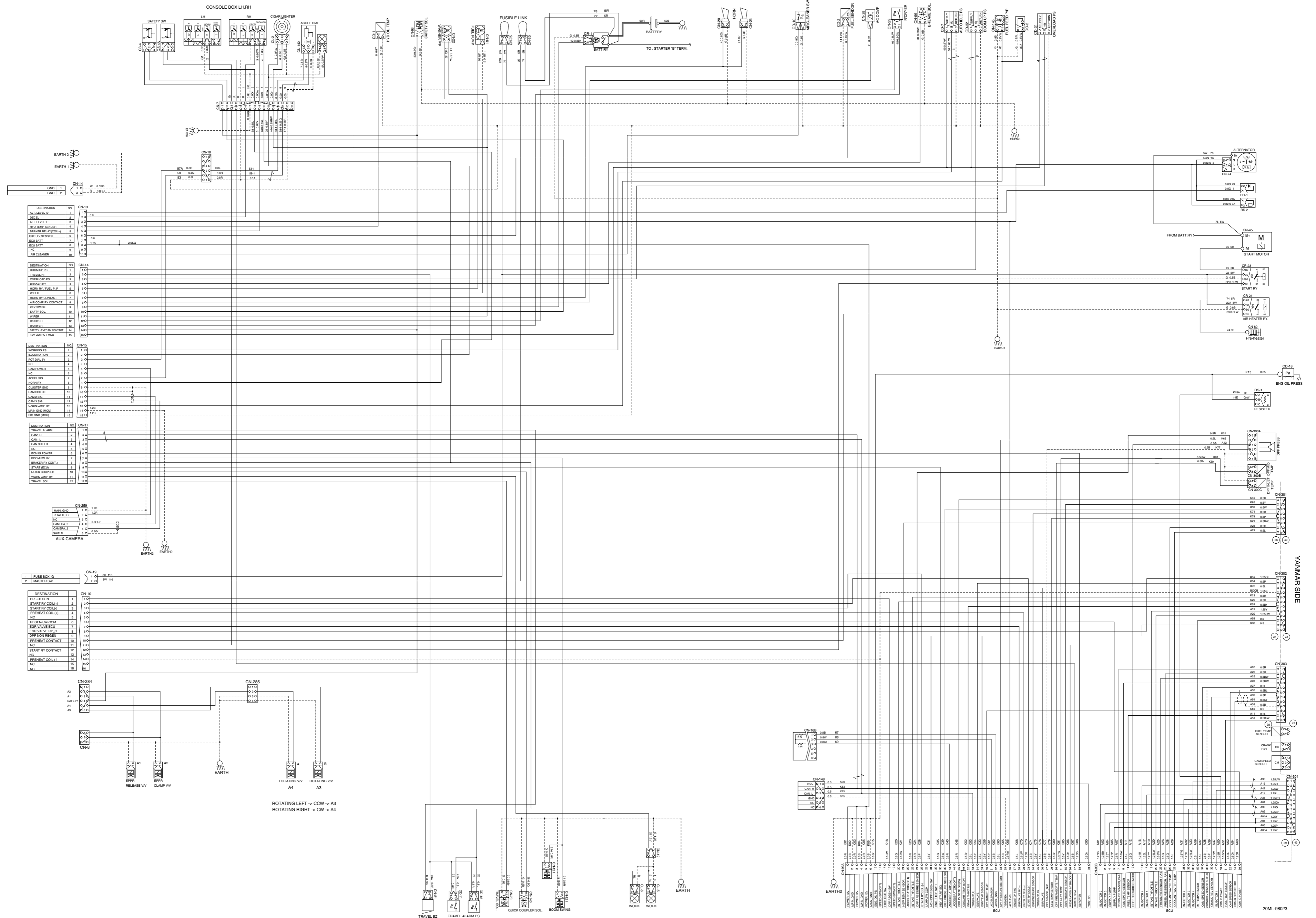

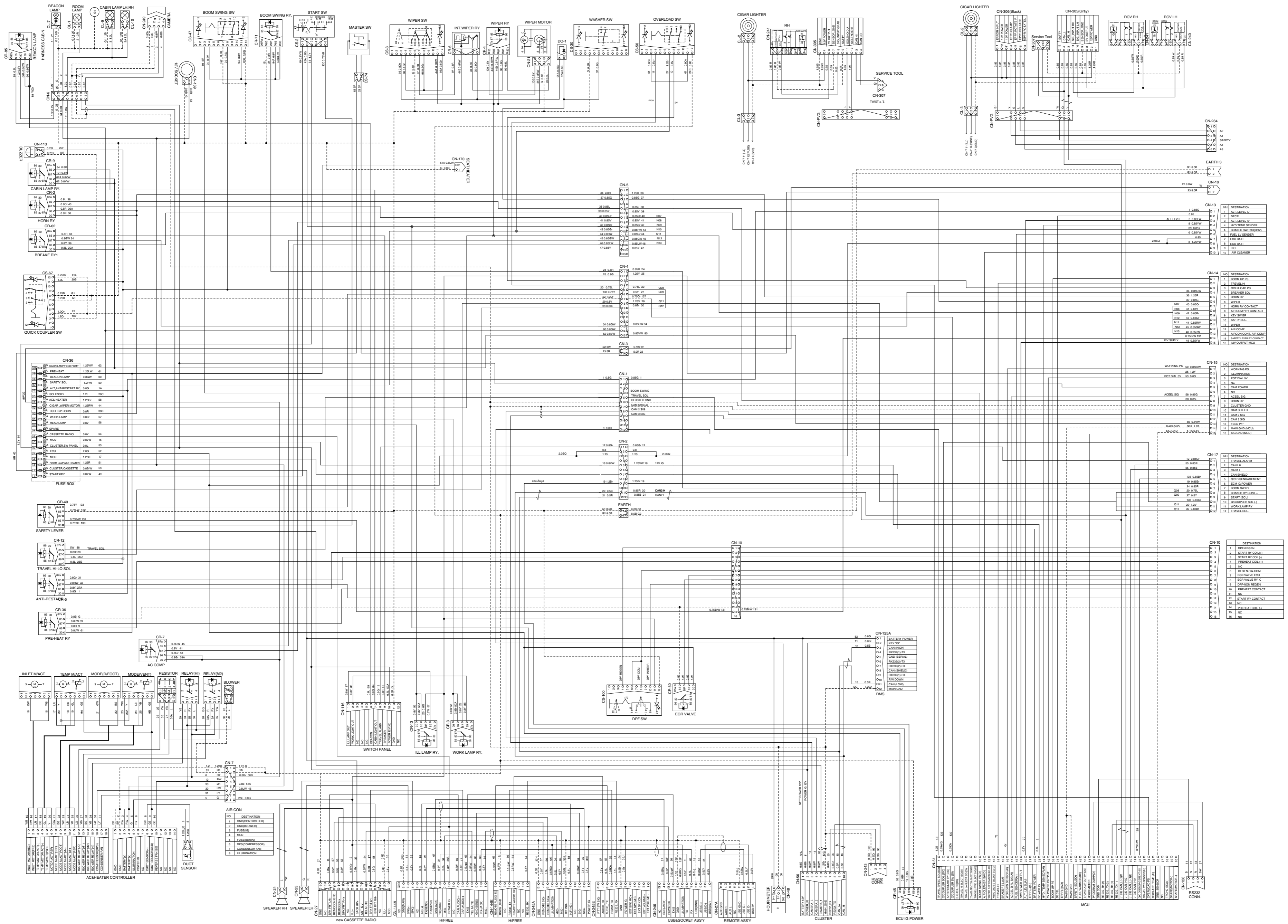

MEMORANDUM

1. POWER CIRCUIT

The negative terminal of battery is grounded to the machine chassis.

When the start switch is in the OFF position, the current flows from the positive battery terminal as shown below.

1) OPERATING FLOW

Battery → Battery relay (CR-1) → Fusible link (CN-60) → I/conn [CN-19 (2)] → Master switch [CS-74]

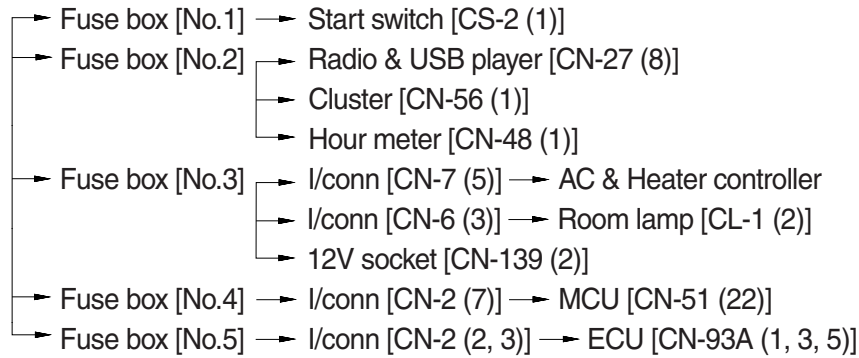

※ I/conn : Intermediate connector

2) CHECK POINT

Engine	Start switch	Check point	Voltage
OFF	OFF	① - GND (battery) ② - GND (battery relay) ③ - GND (fusible link)	10~12.5V

※ GND : Ground

POWER CIRCUIT

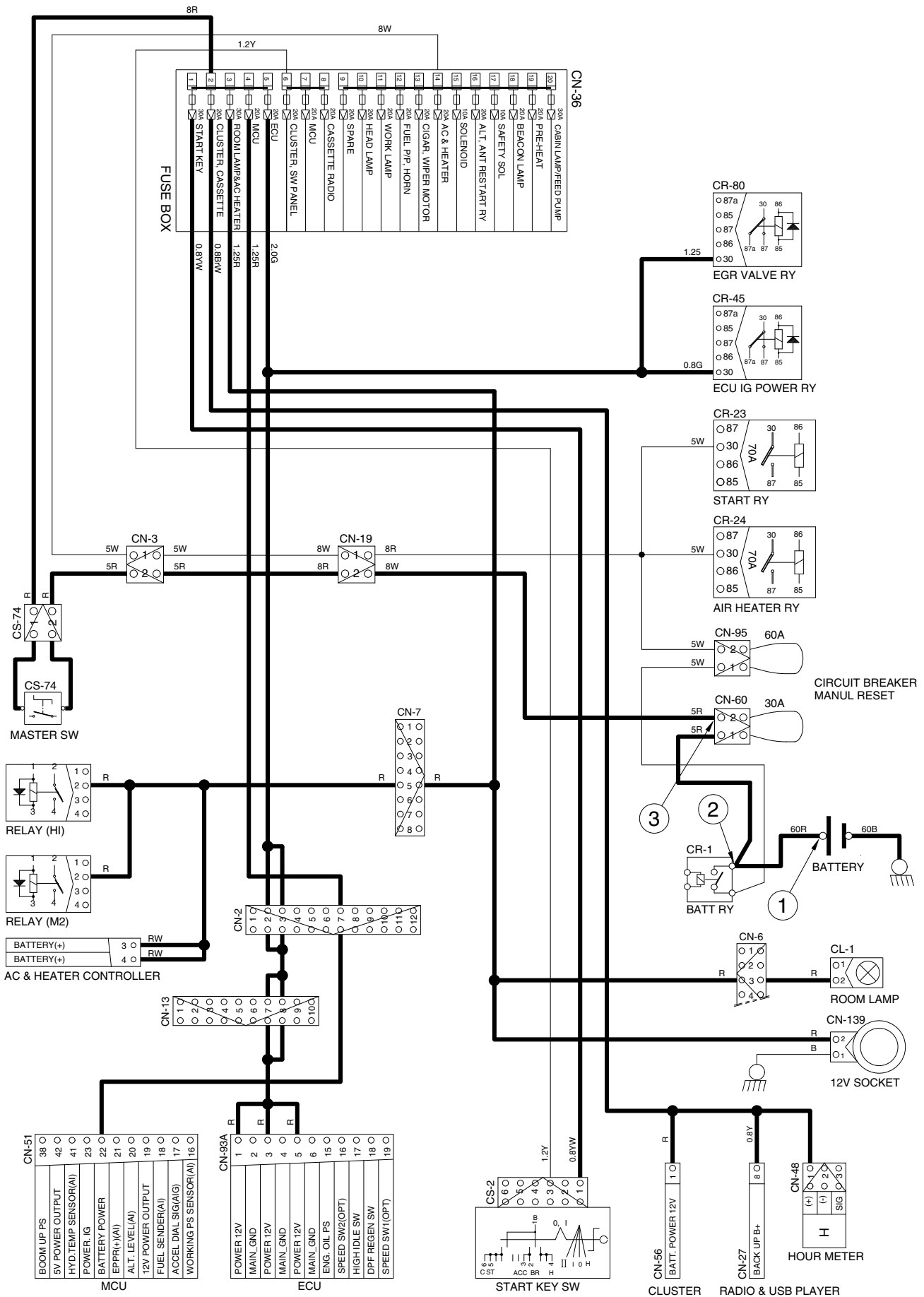

80CR9A4EL04

2. STARTING CIRCUIT

1) OPERATING FLOW

Battery (+) terminal → Battery relay [CR-1] → Fusible link [CN-60] → I/conn [CN-19 (2)]
 → I/conn [CN-3 (2)] → Master switch [CS-74] → Fuse box [No.1] → Start key [CS-2 (1)]

※ Start switch : ON

→ Start switch ON [CS-2 (2)] → ECU IG power relay [CR-45 (86)]
 → I/conn [CN-5 (9)] → I/conn [CN-14 (9)] →
 Battery relay [CR-1] : Battery relay operating (all power is supplied with the electric component)
 → Start switch ON [CS-2 (3)] → Fuse box (all power is supplied with electric component)

※ Start switch : START

Start switch START [CS-2 (5)] → I/conn [CN-4 (6)] → I/conn [CN-14 (9)]
 → ECU [CN-93A (35) → (28, 73)] → I/conn [CN-10 (2, 3)] → I/conn [CN-10 (2, 3)]
 → Anti-restart relay [CR-5 (30) → (87)] → I/conn [CN-10 (12)] → I/conn [CN-10 (12)]
 → Start relay [CR-23 (30) → (87)] → Start motor operating

2) CHECK POINT

Engine	Start switch	Check point	Voltage
Operating	Start	① - GND (battery) ② - GND (start key) ③ - GND (battery relay M4) ④ - GND (starter B ⁺) ⑤ - GND (starter M) ⑥ - GND (start relay) ⑦ - GND (battery relay M8)	10~12.5V

※ GND : Ground

STARTING CIRCUIT

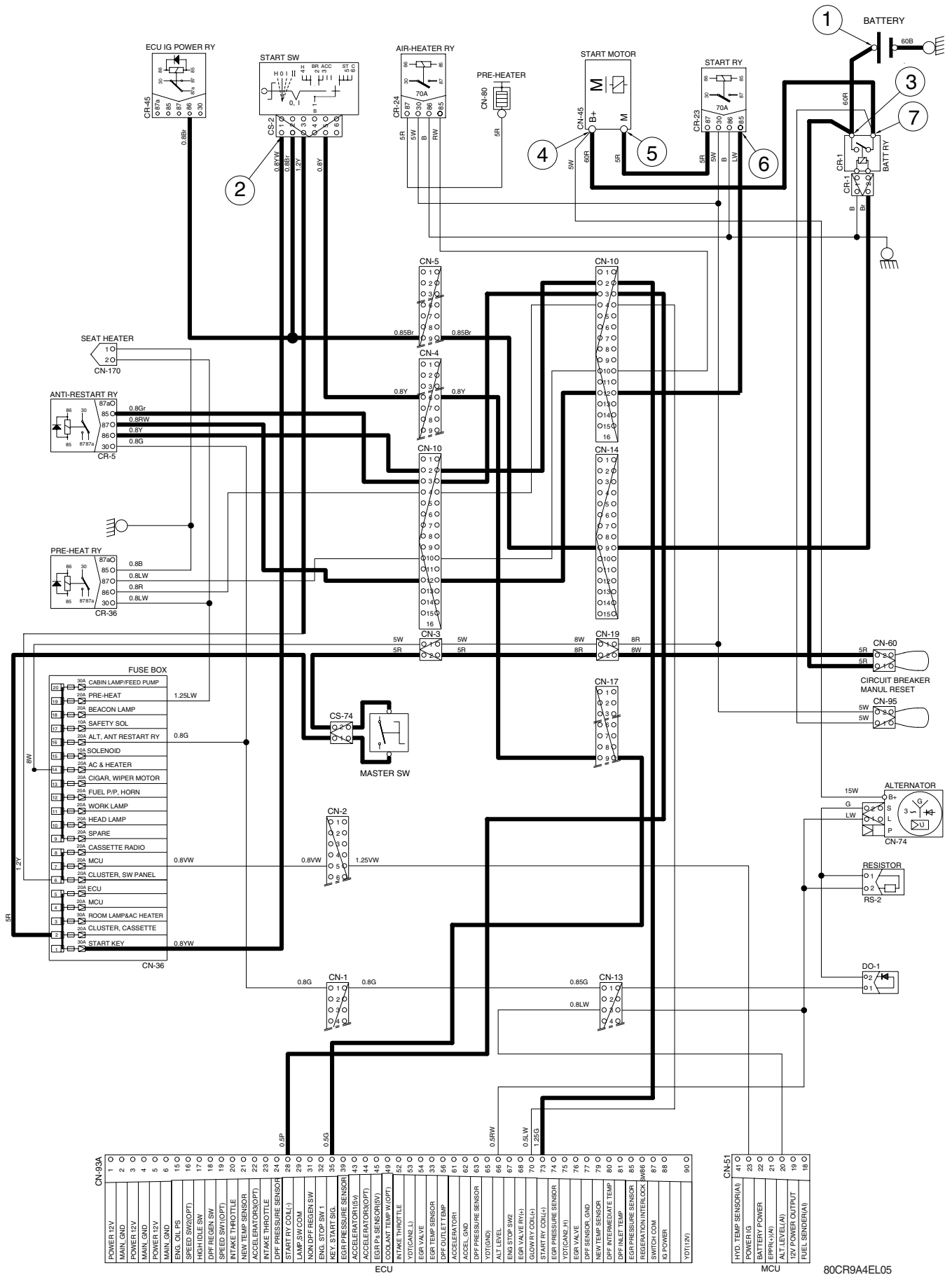

80CR9A4EL05

3. CHARGING CIRCUIT

When the starter is activated and the engine is started, the operator releases the key switch to the ON position.

Charging current generated by operating alternator flows into the battery through the Battery relay (CR-1).

The current also flows from alternator to each electrical component and controller through the fuse box.

1) OPERATING FLOW

(1) Warning flow

Alternator "L" terminal → I/conn [CN-13 (3)] → MCU [CN-51 (20)] → Cluster warning lamp

(2) Charging flow

Alternator "B+" terminal → Battery relay → Battery (+) terminal

2) CHECK POINT

Engine	Start switch	Check point	Voltage
Operating	Start	① - GND (battery voltage) ② - GND (battery relay) ③ - GND (alternator B ⁺ terminal) ④ - GND (alternator L terminal) ⑤ - GND (MCU)	10~12.5V

※ GND : Ground

CHARGING CIRCUIT

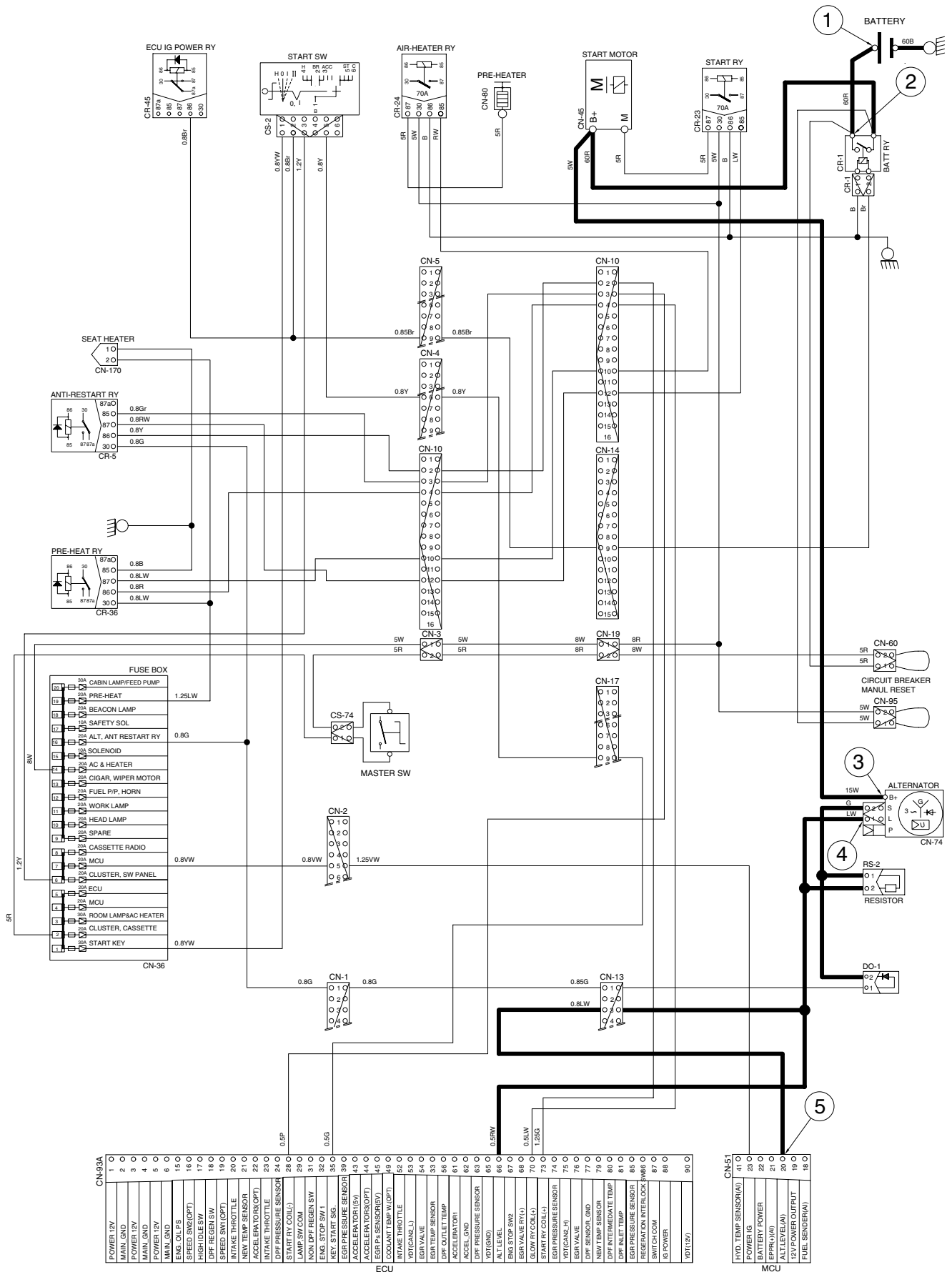

80CR9A4E06

4. ILLUMINATION AND WORK LAMP CIRCUIT

1) OPERATING FLOW

Fuse box (No.10) → Illumination lamp relay [CR-13 (86) → (85)] → Switch panel [CN-116 (1)]

Fuse box (No.11) → Work lamp relay [CR-3 (86) → (85)] → Switch panel [CN-116 (2)]

(1) Head lamp switch ON

Illumination lamp switch ON [CN-116(1)] → Illumination lamp relay [CR-13 (85) → (87)]

→ I/conn [CN-4 (2)] → I/conn [CN-15 (2)] → I/conn [CN-7 (11)] → Cigar lighter [CL-2 (1)]
 → Accel dial [CN-142 (2)]

→ Remote controller illumination ON [CN-245A (9)]

→ Radio & USB player illumination ON [CN-27 (9)]

→ USB & Socket illumination ON [CN-246 (7)]

→ DPF switch illumination ON [CS-100 (11)]

→ I/conn [CN-7 (8)] → AC/Heater controller illumination ON

(2) Work lamp switch ON

Work light switch ON [CN-116 (2)] → Work lamp relay [CR-3 (85) → (87)] → I/conn [CN-4 (8)]

I/conn [CN-17 (11)] → I/conn [CN-12 (2)] → Work lamp ON [CL-5 (2), CL-6 (2)]

2) CHECK POINT

Engine	Start switch	Check point	Voltage
STOP	ON	① - GND (fuse box) ② - GND (switch power input) ③ - GND (switch power output) ④ - GND (head light) ⑤ - GND (fuse box) ⑥ - GND (switch power input) ⑦ - GND (switch power output) ⑧ - GND (work light)	10~12.5V

※ GND : Ground

ILLUMINATION AND WORK LAMP CIRCUIT

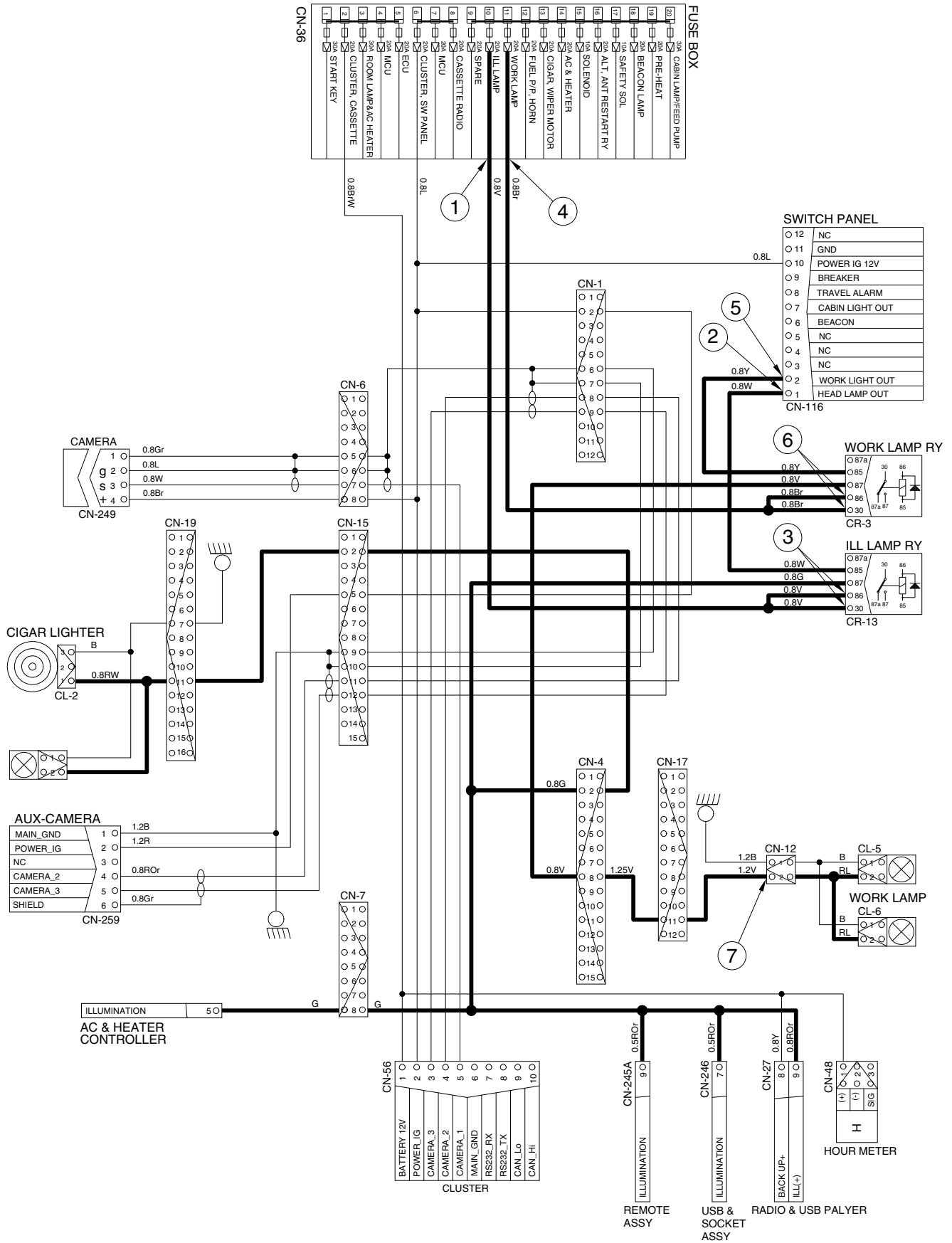

80CR9A4EL07

5. BEACON LAMP AND CAB LAMP CIRCUIT

1) OPERATING FLOW

Fuse box (No.18) → Beacon lamp relay [CR-85(30) → (85)] → Switch panel [CN-116 (6)]

Fuse box (No.20) → Cab lamp relay [CR-9 (30) → (85)] → Switch panel [CN-116 (7)]

(1) Beacon lamp switch ON

Beacon lamp switch ON [CN-116 (6)] → Beacon lamp relay [CR-85 (87)] → I/conn [CN-6 (1)]

→ Beacon lamp ON [CL-7]

(2) Cab lamp switch ON

Cab lamp switch ON [CN-116 (7)] → Cab lamp relay [CR-9 (87)] → I/conn [CN-6 (4)]

→ Cab lamp ON [CL-9 (2), CL-10 (2)]

2) CHECK POINT

Engine	Start switch	Check point	Voltage
STOP	ON	① - GND (fuse box) ② - GND (switch power input) ③ - GND (switch power output) ④ - GND (beacon & cab lamp)	10~12.5V

※ GND : Ground

BEACON LAMP CIRCUIT

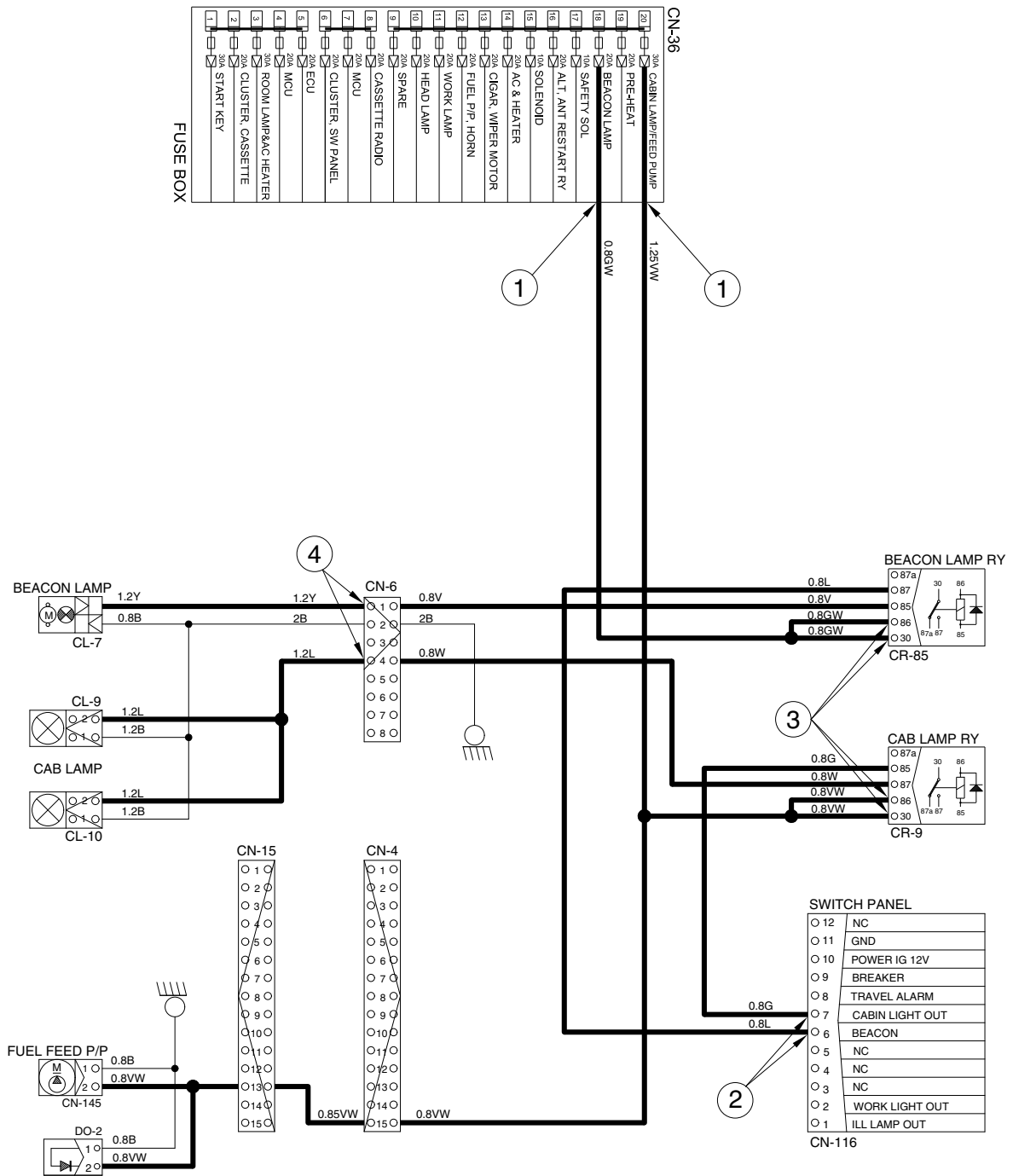

80CR9A4EL08

6. WIPER AND WASHER CIRCUIT

1) OPERATING FLOW

(1) Key switch ON

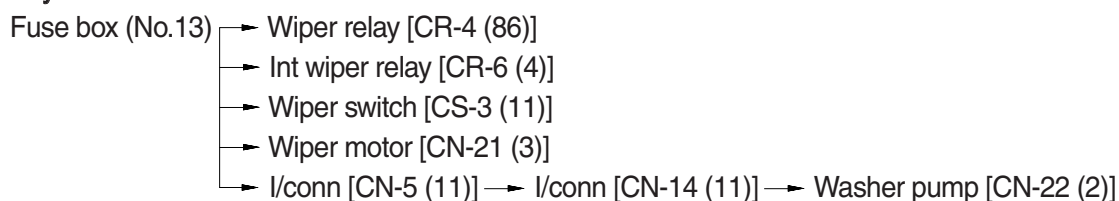

(2) Wipe switch ON : 1st step (low speed)

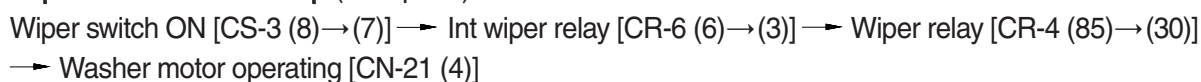

(3) Wiper switch ON : 2nd step (washer)

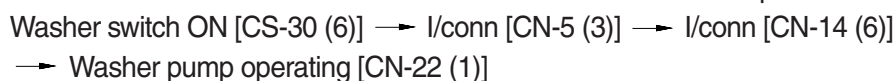
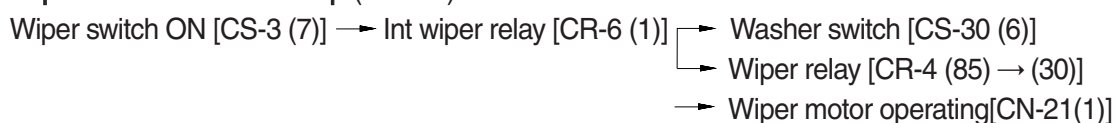

(4) Auto parking (when switch OFF)

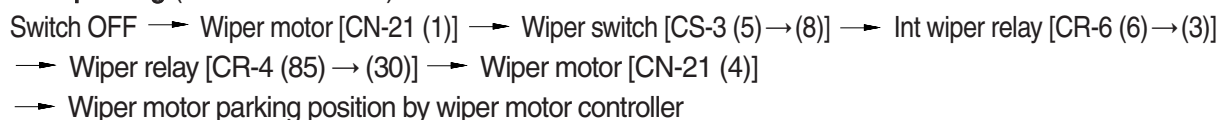

2) CHECK POINT

Engine	Start switch	Check point	Voltage
STOP	ON	① - GND (fuse box) ② - GND (switch power input) ③ - GND (switch power output) ④ - GND (wiper motor)	10~12.5V

※ GND : Ground

WIPER AND WASHER CIRCUIT

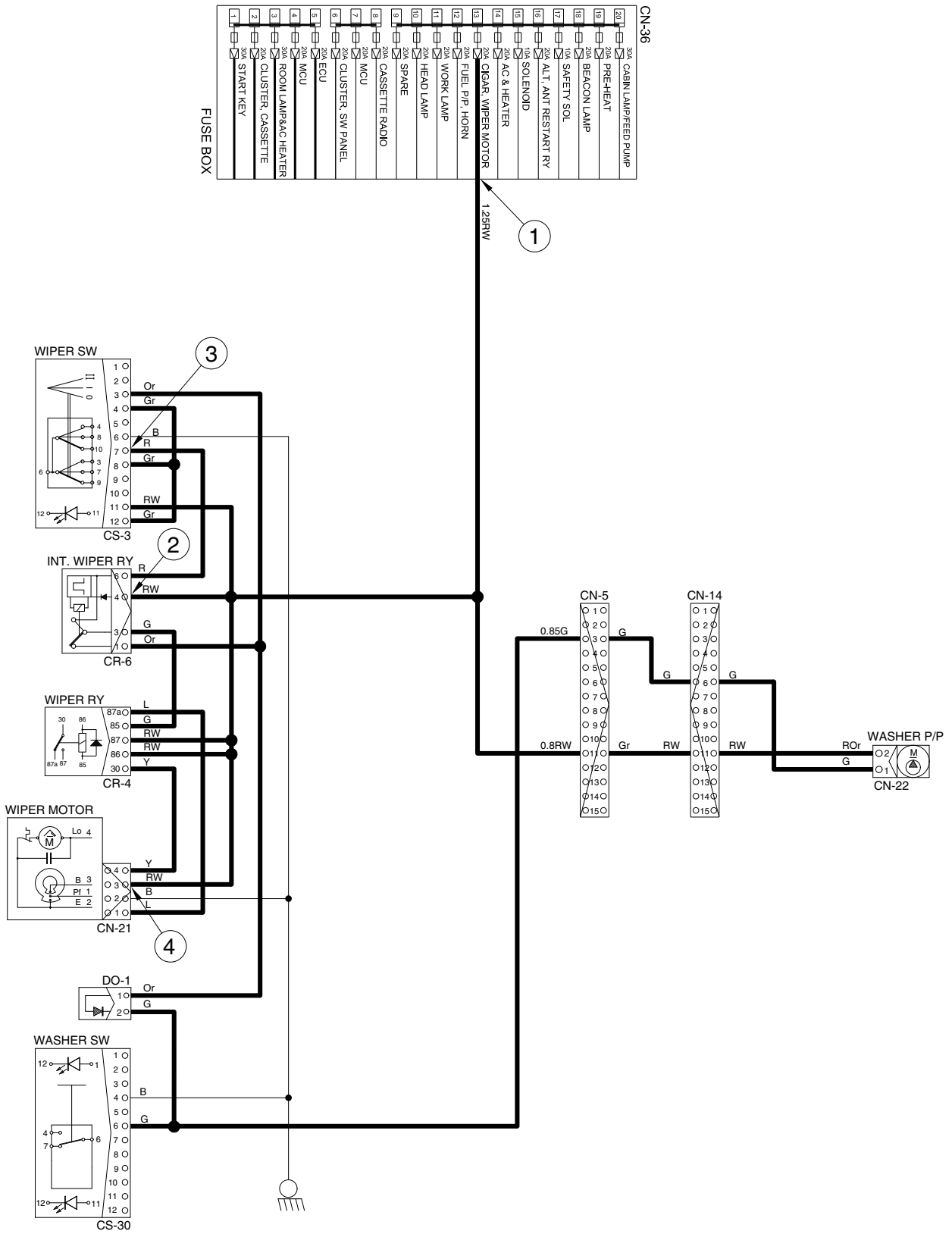

80CR9A4EL09

MONITORING CIRCUIT

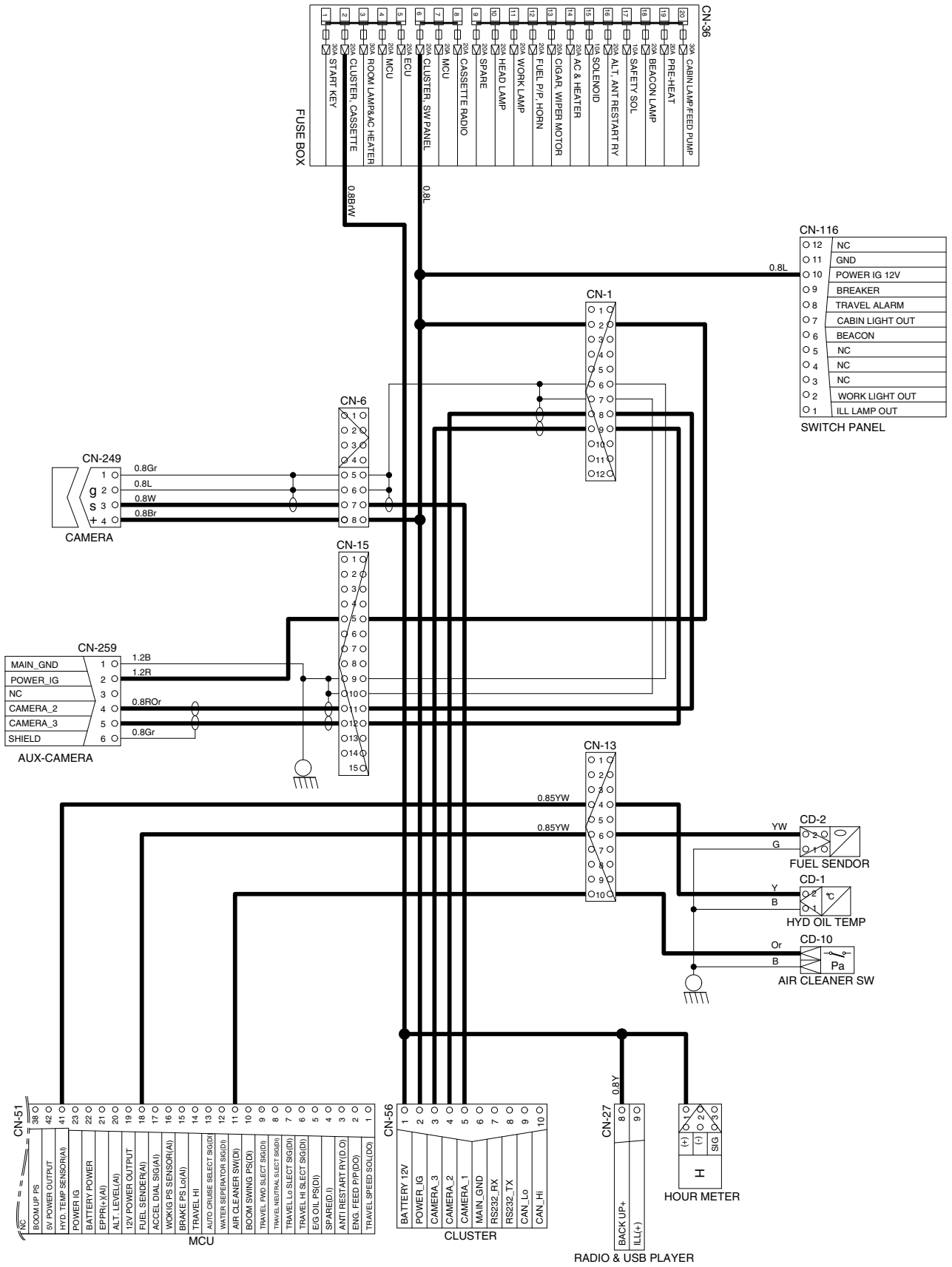

80CR9A4EL10

ELECTRIC CIRCUIT FOR HYDRAULIC

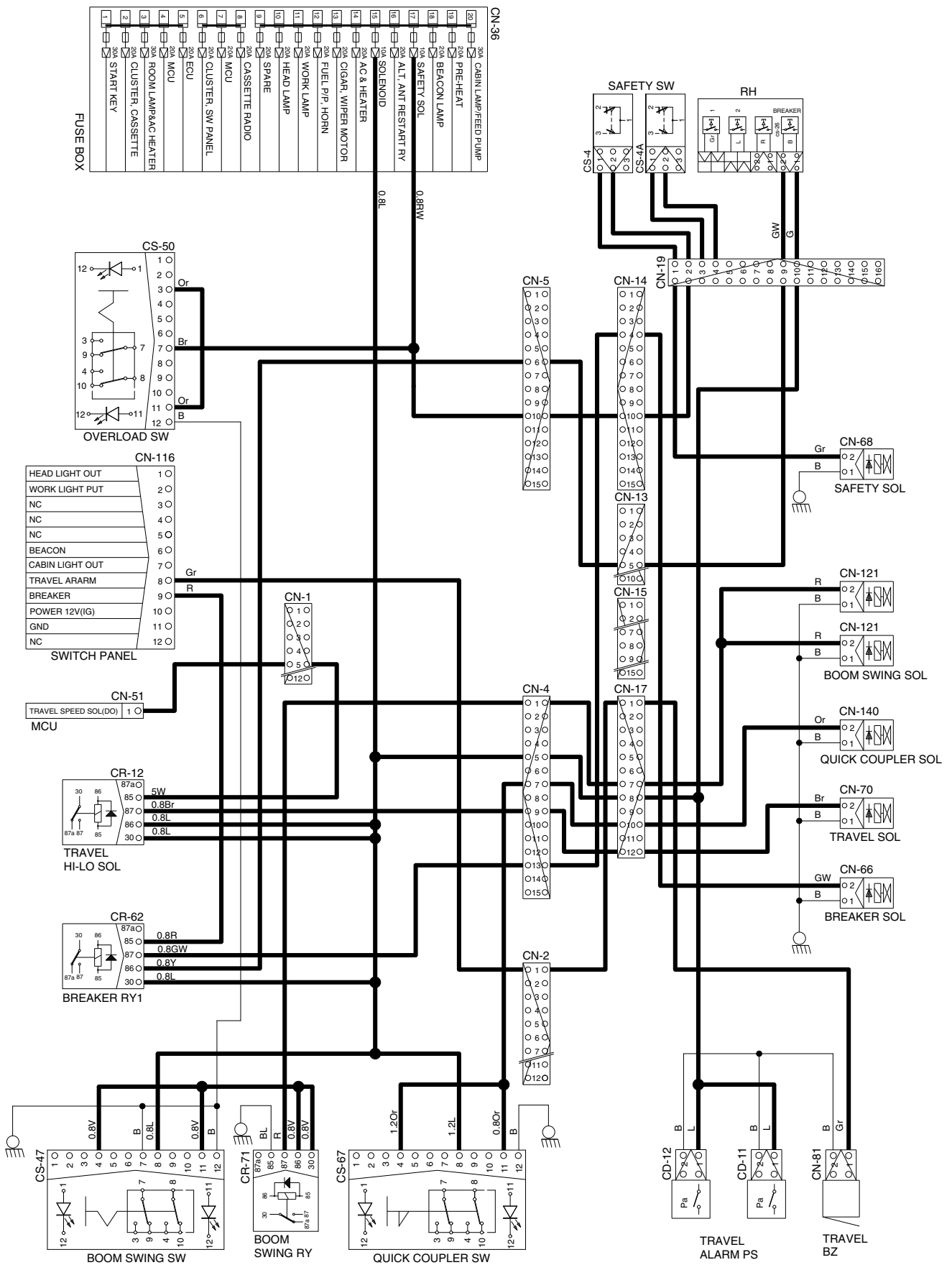

80CR9A4EL11

GROUP 4 ELECTRICAL COMPONENT SPECIFICATION

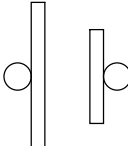
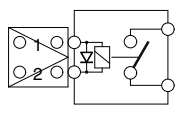
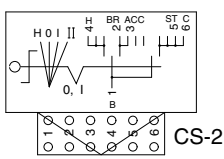
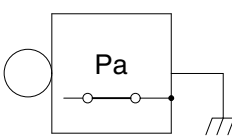
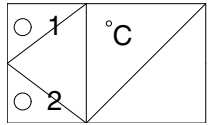
Part name	Symbol	Specification	Check
Battery		12V × 100Ah	※ Check specific gravity 1.280 over : over charged 1.280 ~ 1.250 : normal 1.250 below : recharging
Battery relay	 CR-1	Rated load : 12V 100A (continuity) 1000A (30 second)	※ Check coil resistance Normal : about 12 Ω ※ Check contact Normal : ∞ Ω
Start key	 CS-2	12V	※ Check contact OFF : ∞ Ω (for each terminal) ON : 0 Ω (for terminal 1-3 and 1-2) START : 0 Ω (for terminal 1-5)
Pressure switch (for engine oil)	 CD-18	0.5 kgf/cm ² (N.C TYPE)	※ Check resistance Normal : 0 Ω (CLOSE)
Hydraulic oil temperature sensor	 CD-1	0.5 kgf/cm ² (N.C TYPE)	※ Check resistance 50°C : 804 Ω 80°C : 310 Ω 100°C : 180 Ω

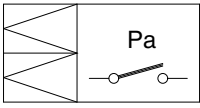
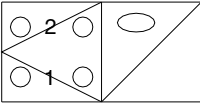
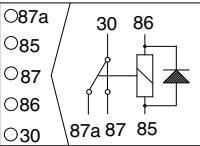
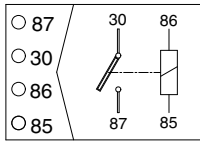
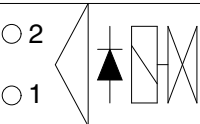
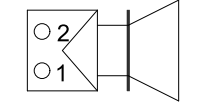
Part name	Symbol	Specification	Check
Air cleaner pressure switch	 <p>CD-10</p>	Pressure: 635mmH ₂ O (N.O TYPE)	※ Check contact Normal : ∞ Ω
Fuel sender	 <p>CD-2</p>	-	※ Check resistance Full : 100 Ω Low : 500 Ω Empty warning : 700 Ω
Relay	 <p>CR-2 CR-3 CR-4 CR-5 CR-7 CR-9 CR-12 CR-13 CR-36 CR-45 CR-62 CR-71 CR-80 CR-85</p>	12V 20A	※ Check resistance Normal : about 200 Ω (for terminal 85-86) : 0 Ω (for terminal 30-87a) : ∞ Ω (for terminal 30-87)
Relay	 <p>CR-23 CR-24</p>	12V 70A	※ Rated coil current 1.2±0.3A
Solenoid valve	 <p>CN-66 CN-68 CN-70 CN-121 CN-140</p>	12V 1A	※ Check resistance Normal : 15~25 Ω (for terminal 1-2)
Speaker	 <p>CN-23(LH) CN-24(RH)</p>	4 Ω 20W	※ Check resistance Normal : 4 Ω

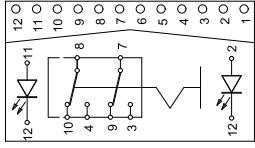
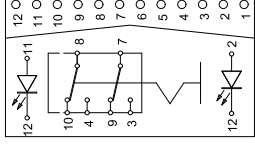
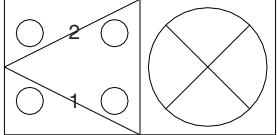
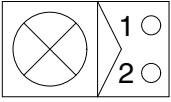
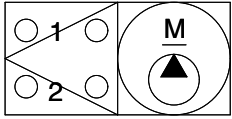
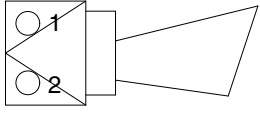
Part name	Symbol	Specification	Check
Boom swing switch	 <p>CS-47</p>	12V 16A	※ Check contact Normal OFF - $\infty \Omega$ (for terminal 1-5,2-6) - 0Ω (for terminal 5-7,6-8)
Quick clamp switch	 <p>CS-67</p>	12V 16A	※ Check contact Normal OFF - $\infty \Omega$ (for terminal 1-5,2-6) - 0Ω (for terminal 5-7,6-8)
Work, cab lamp	 <p>CL-5 CL-6 CL-9 CL-10</p>	12V 65W (H3 TYPE)	※ Check disconnection Normal : 1.2Ω
Room lamp	 <p>CL-1</p>	12V 10W	※ Check disconnection Normal : a few Ω
Fuel filler pump	 <p>CN-145</p>	12V 20A 35 l /min	※ Check operation Supply power (for terminal 1) : 12V
Horn	 <p>CN-20 CN-25</p>	12V	100±5dB

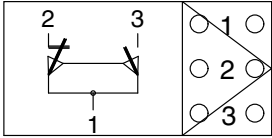
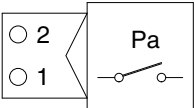
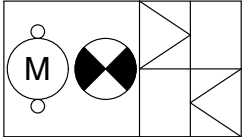
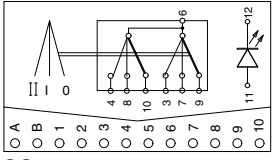
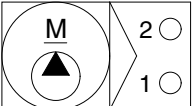
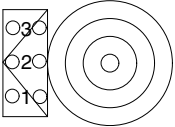
Part name	Symbol	Specification	Check
Safety switch	 <p>CS-4</p>	Micro	※ Check contact Normal : 0 Ω (for terminal A-B) : ∞ Ω (for terminal A-C) Operating : ∞ Ω (for terminal A-B) : 0 Ω (for terminal A-C)
Pressure switch	 <p>CD-11 CD-12</p>	10bar (N.C type)	※ Check contact Normal : 0.1 Ω
Beacon lamp	 <p>CL-7</p>	12V (Strobe type)	※ Check disconnection Normal : a few Ω
Wiper switch	 <p>CS-3</p>	12V 16A	※ Check contact Normal : ∞ Ω
Washer pump	 <p>CN-22</p>	12V 3.8A	※ Check contact Normal : 3 Ω (for terminal 1-2)
Cigar lighter	 <p>CL-2</p>	12V 10A 1.4W	※ Check coil resistance Normal : about 1MΩ ※ Check contact Normal : ∞ Ω Operating time : 5~15sec

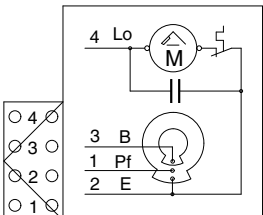
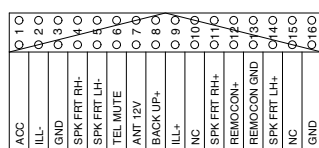
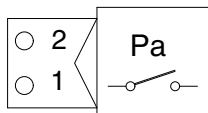
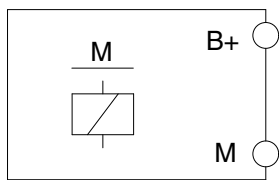
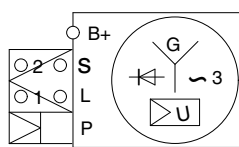
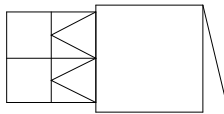
Part name	Symbol	Specification	Check
Wiper motor	 <p>CN-21</p>	12V 3A	※ Check contact Normal : 6 Ω (for terminal 2-6)
Radio & USB player	 <p>CN-27</p>	24V 2A	※ Check voltage 20 ~ 25V (for terminal 1-3, 3-8)
Receiver dryer	 <p>CN-29</p>	12V	※ Check contact Normal : 0 Ω
Starter	 <p>CN-45</p>	12V × 3kW	※ Check contact Normal : 0.1 Ω
Alternator	 <p>CN-74</p>	12V 60A	※ Check contact Normal : 0 Ω (for terminal B ⁺ -1) Normal : 24 ~ 27.5V
Travel buzzer	 <p>CN-81</p>	12V 0.5A	※ Check contact Normal : 5.2 Ω

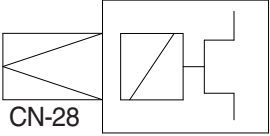
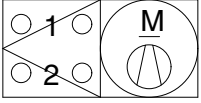
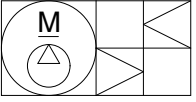
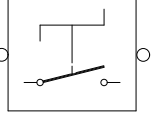
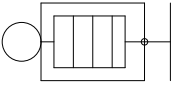
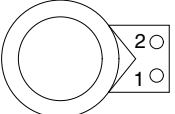
Part name	Symbol	Specification	Check
Compressor	 CN-28	12V 79W	-
Blower fan motor	 CN-83	12V 9.5A	※ Check resistance 2.5 Ω (for terminal 1-2)
Fuel feed pump	 CN-61	12V	-
Master switch		12V 1000A	-
Preheater	 CN-80	12V 42A 500W	-
12V socket	 CN-139	12V 120W	-

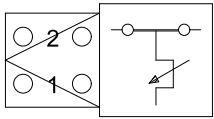
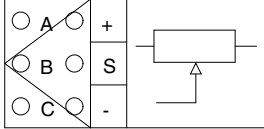
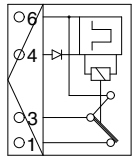
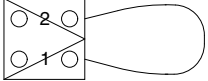
Part name	Symbol	Specification	Check
Duct sensor		<p>1°C OFF 4°C ON</p>	<p>※ Check resistance Normal : 0 Ω (for terminal 1-2) the atmosphere temp : over 4°C</p>
Accel dial	 <p>CN-142</p>	-	<p>※ Check resistance Normal : about 5k Ω (for terminal A-C) ※ Check voltage Normal : about 5V (for terminal A-C) : 2~4.5V (for terminal C-B)</p>
Int wiper relay	 <p>CR-6</p>	12V 12A	-
Fusible link	 <p>CN-60 CN-95</p>	<p>12V, 30A (CN-65) 12V, 60A (CN-95)</p>	-

GROUP 5 CONNECTORS

1. CONNECTOR DESTINATION

Connector number	Type	No. of pin	Destination	Connector part No.	
				Female	Male
CN-1	AMP	12	Cab room harness - Main harness	S816-012002	174663-2
CN-2	AMP	12	Aircon harness - Cab room harness	S816-012002	174663-2
CN-3	YAZAKI	2	Fusible link - Fuse box	S813-030201	S813-130201
CN-4	AMP	15	Cab room harness - Main harness	2-85262-1	368301-1
CN-5	AMP	15	Cab room harness - Main harness	2-85262-1	368301-1
CN-6	DEUTSCH	8	Cab harness - Cab room lamp harness	DT06-8S	DT04-8P
CN-7	AMP	16	Main harness - Console harness	368047-1	368050-1
CN-10	AMP	16	Bottom harness - Main harness	368047-1	368050-1
CN-12	AMP	2	Work lamp harness - Boom harness	S816-002002	S816-102002
CN-13	AMP	10	Bottom harness - Main harness	174655-2	174557-2
CN-14	AMP	15	Bottom harness - Main harness	2-85262-1	368301-1
CN-15	AMP	15	Main harness - Bottom harness	2-85262-1	368301-1
CN-17	AMP	12	Main harness - Bottom harness	S816-012002	S816-112002
CN-19	YAZAKI	2	Main harness - Bottom harness	S813-030201	S813-130201
CN-20	DEUTSCH	2	Horn	DT06-2S-EP06	-
CN-21	AMP	12	Wiper harness	S816-012002	-
CN-22	KET	2	Washer tank	MG640605	-
CN-23	KET	2	Speaker LH	MG610070	-
CN-24	KET	2	Speaker RH	MG610070	-
CN-25	DEUTSCH	2	Horn	DT06-2S-EP06	-
CN-27	KUM	16	Radio and USB player	PK145-16017	-
CN-28	AMP	1	Air conditioner compressor	S810-001202	-
CN-29	KET	2	Receiver dryer	MG640795	-
CN-36	-	-	Fuse box	21L7-00250	-
CN-45	KET	1	Starter	ST710246-2	ST710592-2
CN-48	-	3	Hour meter	2-520193-2	-
CN-51	AMP	70	MCU	1-968879-1	-
CN-55	AMP	2	Travel alarm PS	S816-002002	S816-102002
CN-56	AMP	10	Cluster	-	S816-110002
CN-60	YAZAKI	2	Fusible link	-	7122-4125-50
CN-61	TERM	1	Fuel filler pump	S822-014000	S822-114000
CN-66	DEUTSCH	2	Breaker solenoid	DT06-2S-EP06	-
CN-68	DEUTSCH	2	Safety solenoid	DT06-2S-EP06	-
CN-70	DEUTSCH	2	Travel HI-LO solenoid	DT06-2S-EP06	-

Connector number	Type	No. of pin	Destination	Connector part No.	
				Female	Male
CN-74	KET	2	Alternator	ST710285-2	-
CN-80	AMP	1	Pre heater	ST710384-2	-
CN-81	TERM	2	Travel buzzer	S822-014000	S822-114000
CN-83	AMP	2	Air-con fan	MG640188-5	-
CN-93A	AMP	94	ECU	3-1355136-3	-
CN-93B	AMP	60	ECU	1897635-2	-
CN-95	YAZAKI	2	Fusible link	4	S813-130201
CN-116	AMP	12	Switch panel	368542-1	-
CN-121	DEUTSCH	1	Boom swing	DT06-2S-EP06	-
CN-126	-	4	RS232 connector	-	-
CN-139	AMP	2	12V socket	S810-002202	-
CN-140	DEUTSCH	2	Quick coupler	DT06-2S-EP06	DT04-2P-E005
CN-142	DEUTSCH	3	Accel dial	DT06-3S-EP06	-
CN-144	AMP	2	Handsfree	S810-002202	-
CN-145	KET	2	Fuel feed pump	7123-6423-30	-
CN-148	DEUTSCH	6	Service tool	DT06-6S-E008	-
CN-170	PACKARD	2	Seat heat switch	12162017	-
CN-243	-	4	RS232 connector	-	-
CN-245	AMP	12	Remote controller assy	368542-1	-
CN-246	AMP	12	USB & Socket assy	174045-2	-
CN-249	DEUTSCH	4	Rear camera	-	DT04-4P
CN-258	KET	1	Aircon comp power	MG640944-5	MG650943-5
CN-263	DEUTSCH	2	Aircon comp relay	DT06-2S-EP06	DT04-2P-E005
CN-300A	AMP	6	DPF pressure	1438153-5	-
CN-300B	FCI	2	DPF mid temperature	542002006	-
CN-300C	FCI	2	DPF inlet temperature	542002008	-
CN-301	AMP	8	EGR sensor	776532-1	-
CN-302	AMP	12	EGR valve	776533-1	-
· LAMP					
CL-1	KET	2	Room lamp	MG610392	-
CL-2	AMP	3	Cigar light	S810-003202	-
CL-3	DEUTSCH	2	Head lamp	DT06-2S-EP06	DT04-2P-E005
CL-4	DEUTSCH	2	Head lamp	DT06-2S-EP06	DT04-2P-E005
CL-5	DEUTSCH	2	Work lamp	DT06-2S-EP06	-
CL-6	DEUTSCH	2	Work lamp	DT06-2S-EP06	-
CL-7	-	1	Beacon lamp	-	S822-114000
CL-9	DEUTSCH	2	Cab lamp	DT06-2S-EP06	-
CL-10	DEUTSCH	1	Cab lamp	DT06-2S-EP06	-

Connector number	Type	No. of pin	Destination	Connector part No.	
				Female	Male
· RELAY					
CR-1	AMP	2	Battery relay	S816-002002	S816-102002
CR-2	AMP	4	Horn relay	S810-004002	-
CR-5	AMP	4	Anti-restart relay	S810-004002	-
CR-6	KET	6	Int wiper relay	S810-006002	-
CR-12	AMP	4	Travel relay	S810-004002	-
CR-23	KET	2	Start relay	S814-002001	-
CR-24	KET	2	Air heater relay	S814-002001	-
CR-33	AMP	4	Air-con fan relay	S810-004002	-
CR-36	AMP	4	Pre-heater relay	S810-004002	-
CR-45	AMP	4	ECU power	S810-004002	-
· SENDER					
CD-1	AMP	2	Hydraulic temp sender	85202-1	-
CD-2	AMP	2	Fuel sender	-	S816-102002
CD-7	DEUTSCH	3	Auto idle pressure switch	DT06-3S-EP06	-
CD-10	KET	1	Air cleaner switch	ST730057-2	-
CD-11	-	2	Travel pressure switch	MG640795	-
CD-12	-	2	Travel pressure switch	MG640795	-
CD-18	YAZAKI	1	Engine oil pressure	7123-5014	-
CD-32	DEUTSCH	3	Boom up pressure	DT06-3S-EP06	-
DO-1	-	2	Diode	21EA-50570	-
DO-2	-	2	Diode	21EA-50570	-
DO-3	-	2	Diode	21EA-50570	-
· SWITCH					
CS-2	KET	6	Start key switch	S814-006000	-
CS-3	SWF	12	Wiper switch	585790	-
CS-4	AMP	3	Safety switch	S816-003002	-
CS-4A	AMP	3	Safety switch	-	174359-2
CS-5	DEUTSCH	2	Horn-LH switch	-	DT04-2P-E005
CS-26	DEUTSCH	2	Breaker switch	-	DT04-2P-E005
CS-30	SWF	12	Wiper washer	585790	-
CS-47	SWF	12	Boom swing switch	585790	-
CS-67	SWF	12	Quick coupler switch	589790	-
CS-74	YAZAKI	2	Master switch	S813-030201	S813-130201
CS-100	SWF	12	DPF switch	589790	-

2. CONNECTION TABLE FOR CONNECTORS

1) PA TYPE CONNECTOR

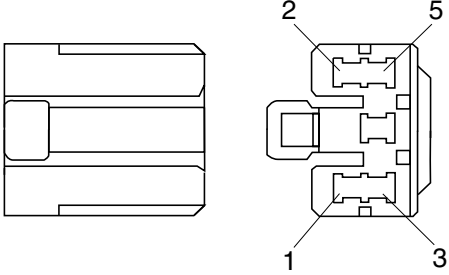
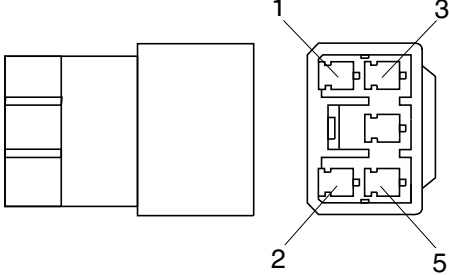
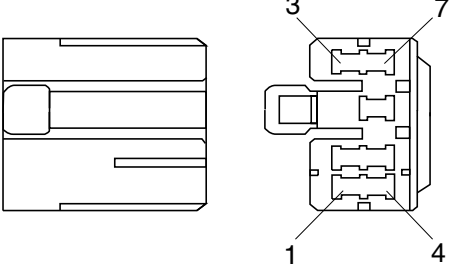
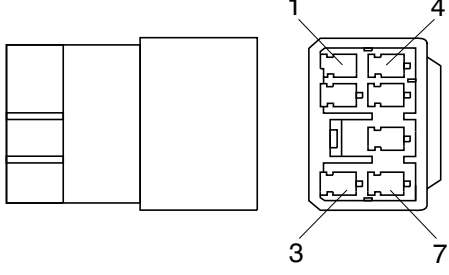
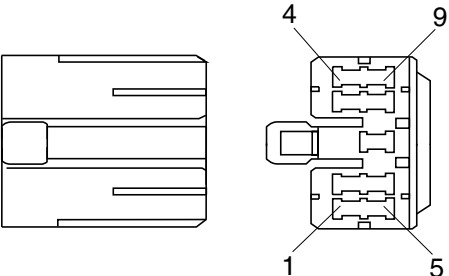
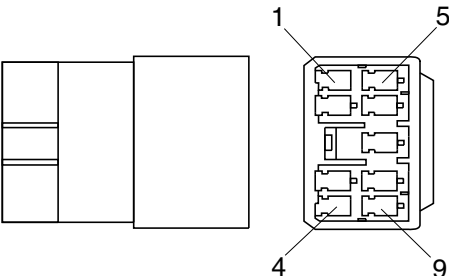
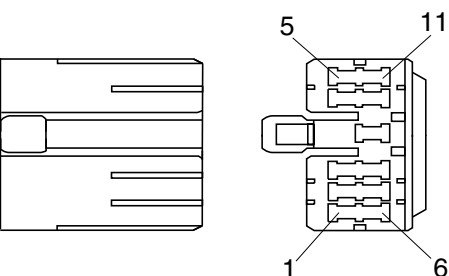
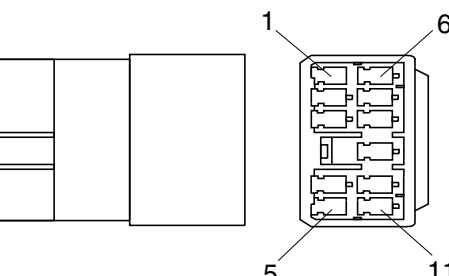
No. of pin	Receptacle connector (female)	Plug connector (male)
5	 <p style="text-align: center;">S811-005002</p>	 <p style="text-align: center;">S811-105002</p>
7	 <p style="text-align: center;">S811-007002</p>	 <p style="text-align: center;">S811-107002</p>
9	 <p style="text-align: center;">S811-009002</p>	 <p style="text-align: center;">S811-109002</p>
11	 <p style="text-align: center;">S811-011002</p>	 <p style="text-align: center;">S811-111002</p>

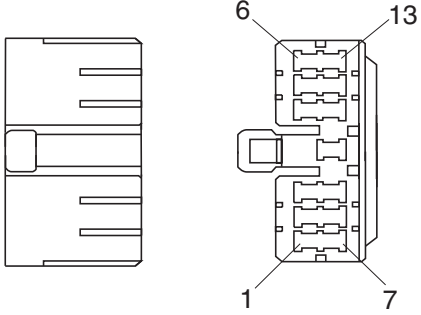
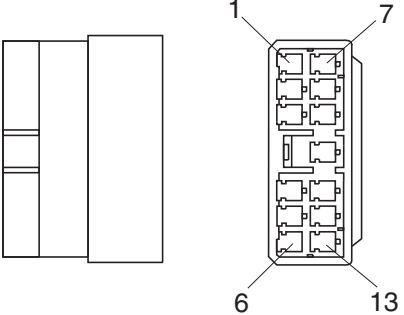
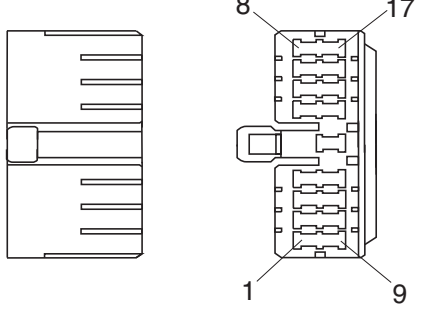
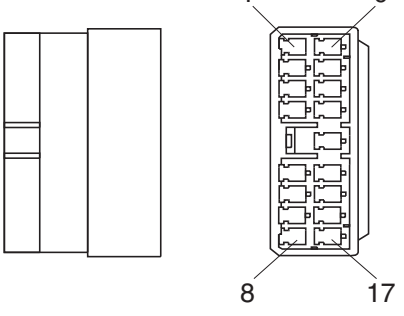
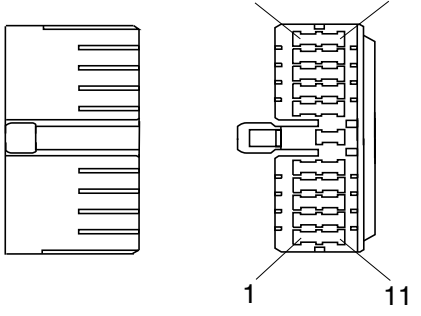
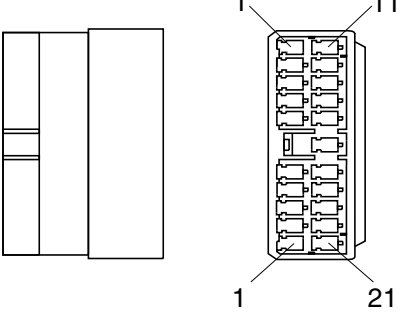
No. of pin	Receptacle connector (female)	Plug connector (male)
13	 <p style="text-align: center;">S811-013002</p>	 <p style="text-align: center;">S811-113002</p>
17	 <p style="text-align: center;">S811-017002</p>	 <p style="text-align: center;">S811-117002</p>
21	 <p style="text-align: center;">S811-021002</p>	 <p style="text-align: center;">S811-121002</p>

2) J TYPE CONNECTOR

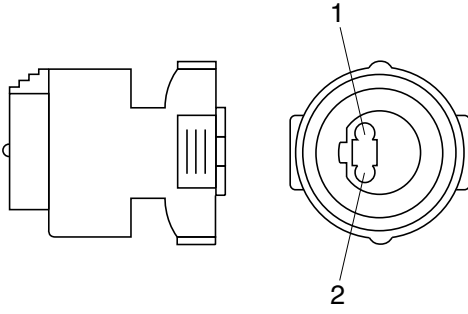
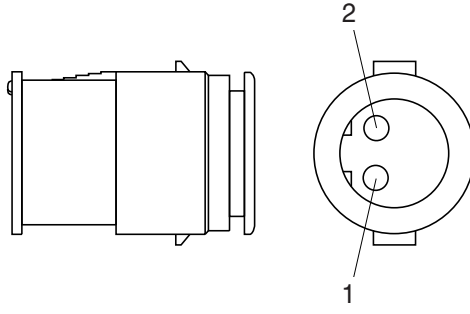
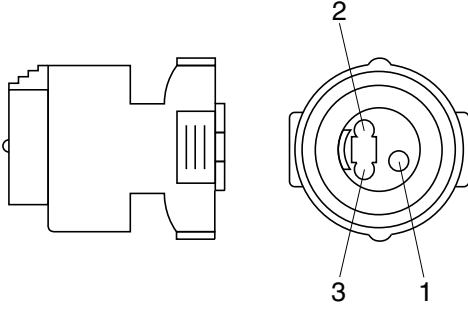
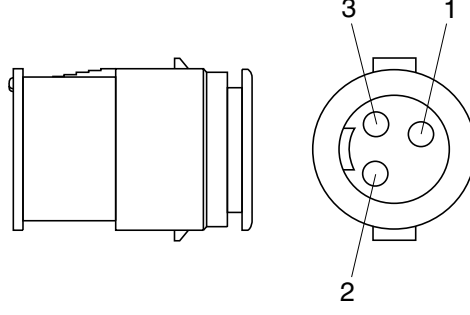
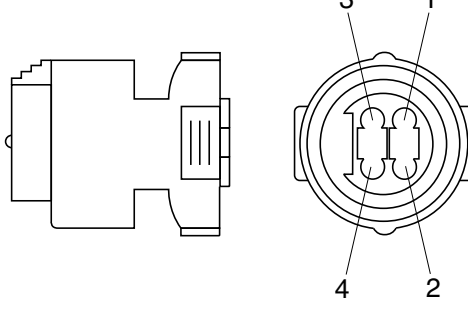
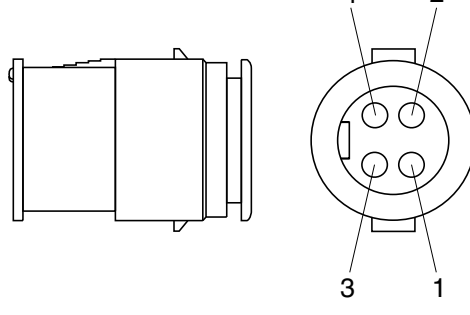
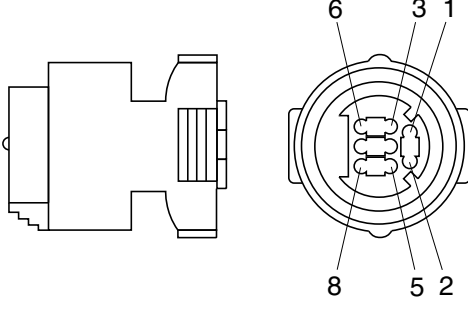
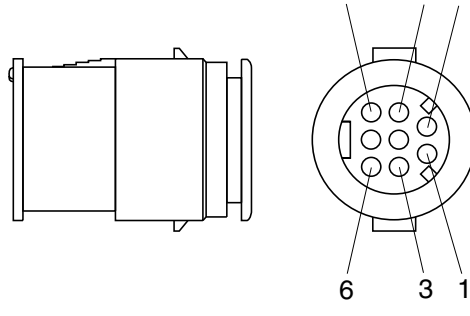
No. of pin	Receptacle connector (female)	Plug connector (male)
2	 <p style="text-align: center;">S816-002001</p>	 <p style="text-align: center;">S816-102001</p>
3	 <p style="text-align: center;">S816-003001</p>	 <p style="text-align: center;">S816-103001</p>
4	 <p style="text-align: center;">S816-004001</p>	 <p style="text-align: center;">S816-104001</p>
8	 <p style="text-align: center;">S816-008001</p>	 <p style="text-align: center;">S816-108001</p>

3) SWP TYPE CONNECTOR

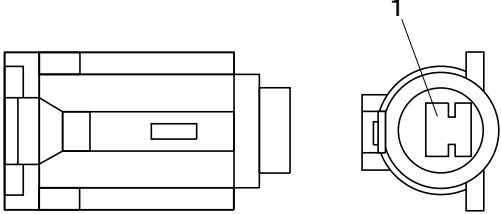
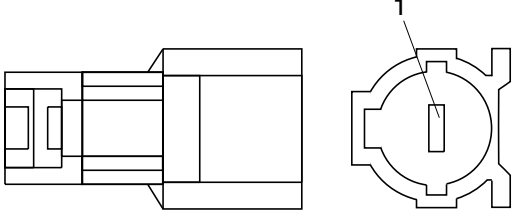
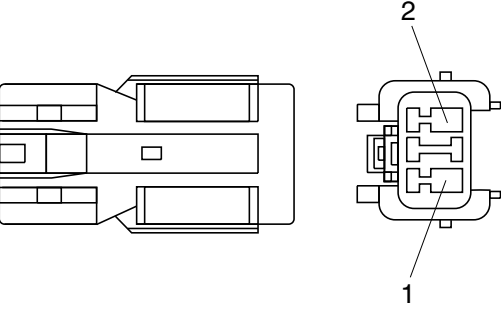
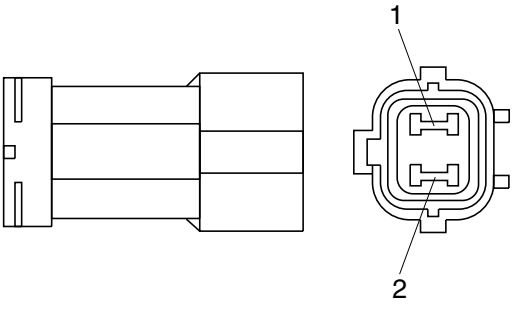
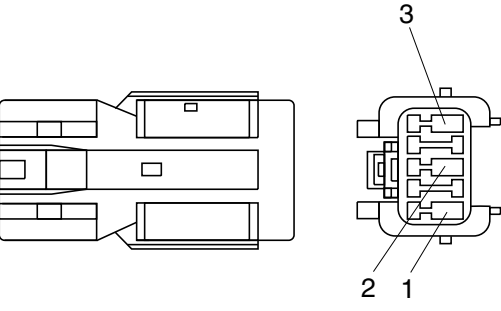
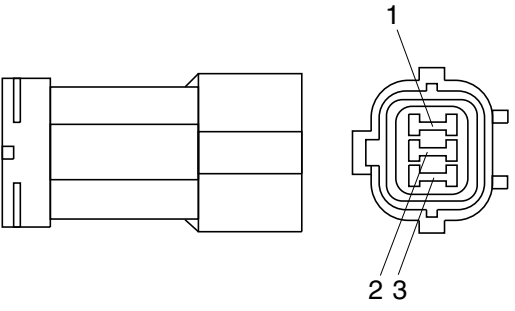
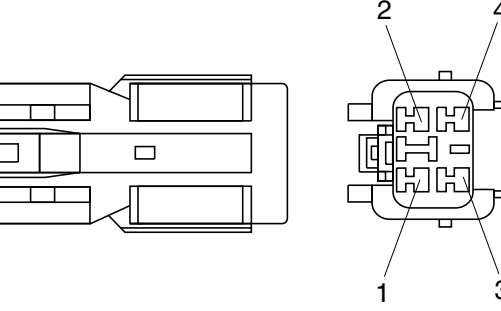
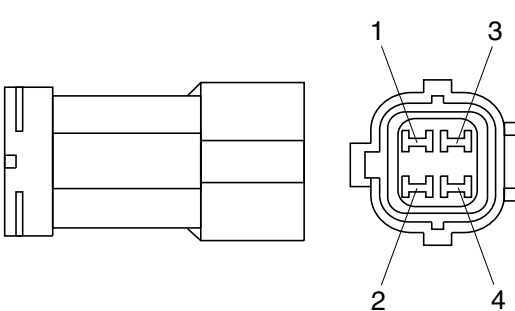
No. of pin	Receptacle connector (female)	Plug connector (male)
1	 <p data-bbox="687 680 836 712">S814-001000</p>	 <p data-bbox="1241 680 1390 712">S814-101000</p>
2	 <p data-bbox="687 1088 836 1120">S814-002000</p>	 <p data-bbox="1241 1088 1390 1120">S814-102000</p>
3	 <p data-bbox="687 1496 836 1527">S814-003000</p>	 <p data-bbox="1241 1496 1390 1527">S814-103000</p>
4	 <p data-bbox="687 1904 836 1935">S814-004000</p>	 <p data-bbox="1241 1904 1390 1935">S814-104000</p>

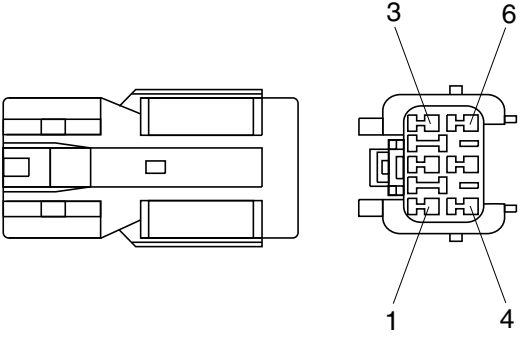
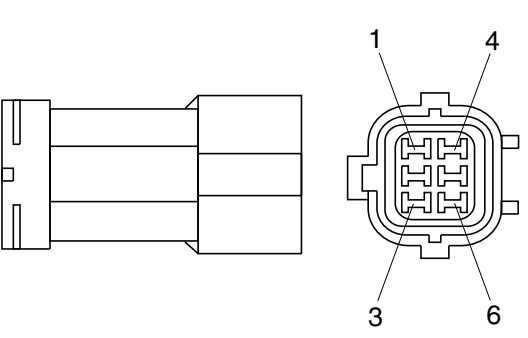
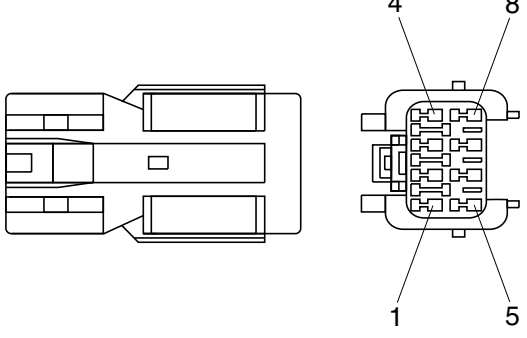
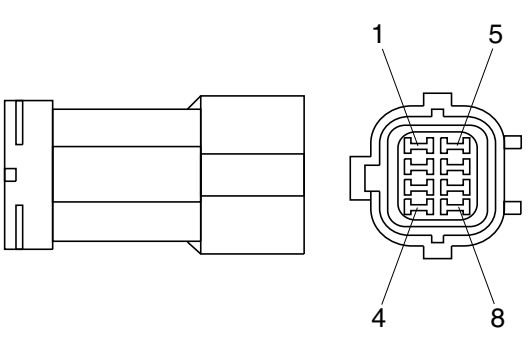
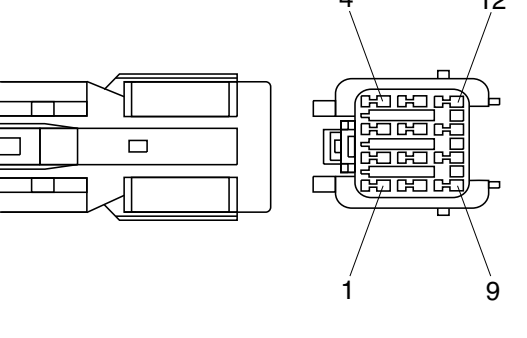
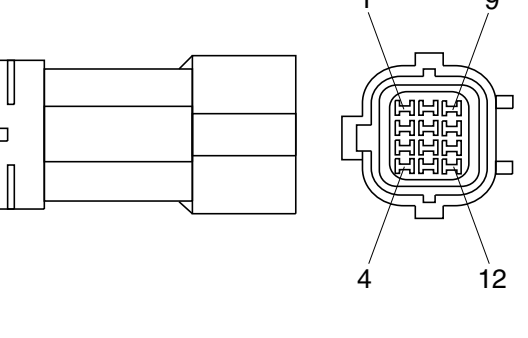
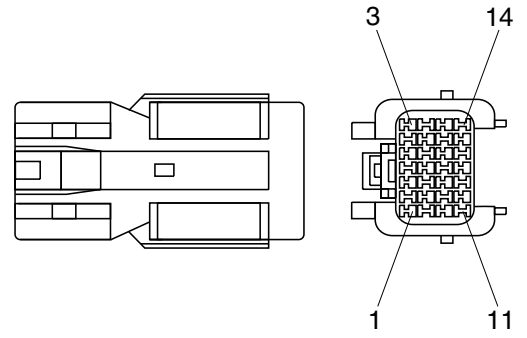
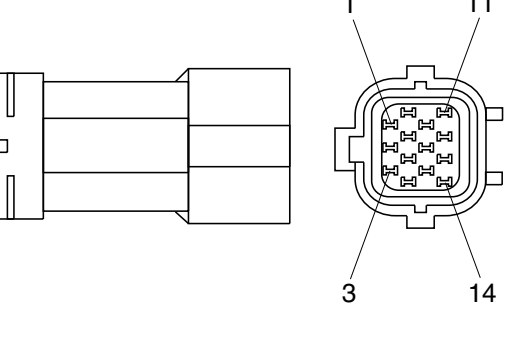
No. of pin	Receptacle connector (female)	Plug connector (male)
6	 <p data-bbox="686 638 837 672">S814-006000</p>	 <p data-bbox="1244 638 1396 672">S814-106000</p>
8	 <p data-bbox="686 1041 837 1075">S814-008000</p>	 <p data-bbox="1244 1041 1396 1075">S814-108000</p>
12	 <p data-bbox="686 1444 837 1478">S814-012000</p>	 <p data-bbox="1244 1444 1396 1478">S814-112000</p>
14	 <p data-bbox="686 1848 837 1881">S814-014000</p>	 <p data-bbox="1244 1848 1396 1881">S814-114000</p>

4) CN TYPE CONNECTOR

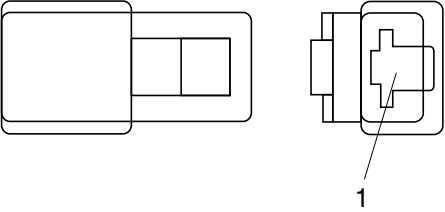
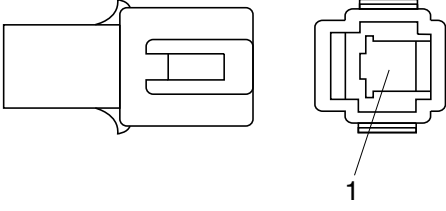
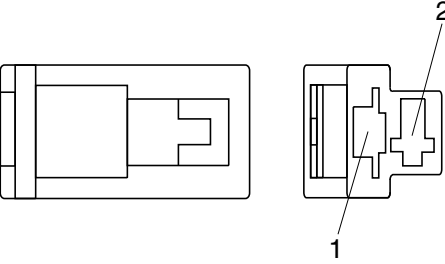
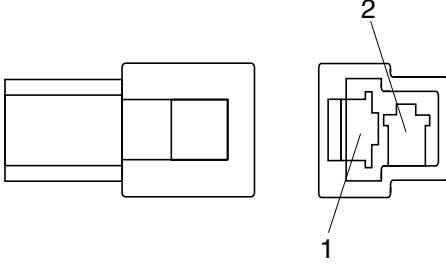
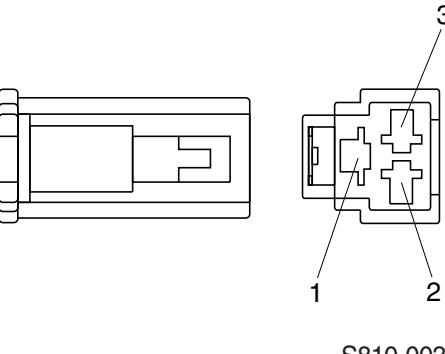
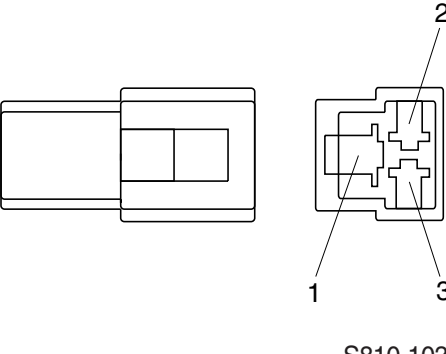
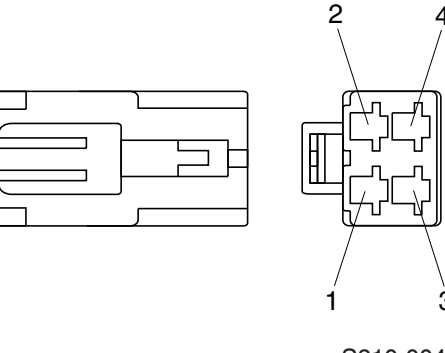
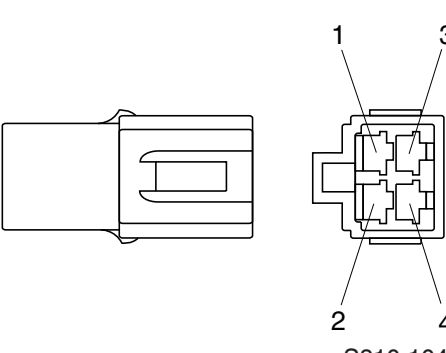
No. of pin	Receptacle connector (female)	Plug connector (male)
1	 <p style="text-align: center;">S810-001202</p>	 <p style="text-align: center;">S810-101202</p>
2	 <p style="text-align: center;">S810-002202</p>	 <p style="text-align: center;">S810-102202</p>
3	 <p style="text-align: center;">S810-003202</p>	 <p style="text-align: center;">S810-103202</p>
4	 <p style="text-align: center;">S810-004202</p>	 <p style="text-align: center;">S810-104202</p>

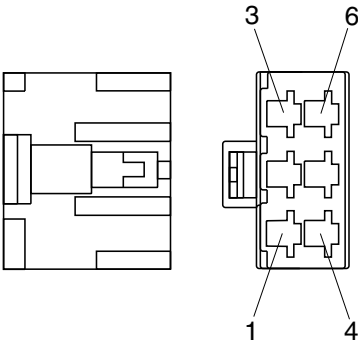
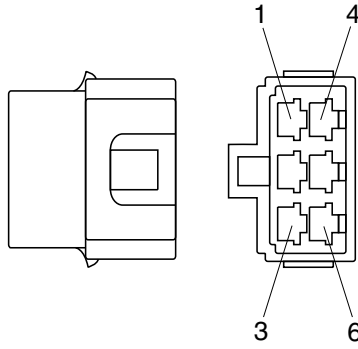
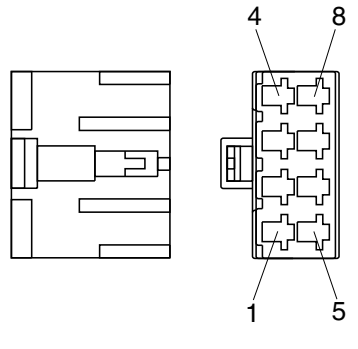
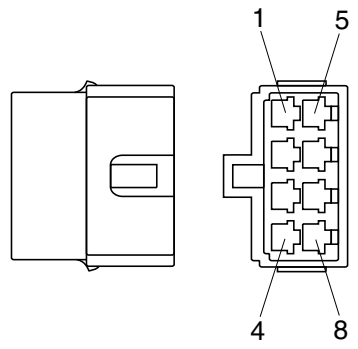
No. of pin	Receptacle connector (female)	Plug connector (male)
6	 <p data-bbox="686 638 837 672">S810-006202</p>	 <p data-bbox="1244 638 1396 672">S810-106202</p>
8	 <p data-bbox="686 1041 837 1075">S810-008202</p>	 <p data-bbox="1244 1041 1396 1075">S810-108202</p>

5) 375 FASTEN TYPE CONNECTOR

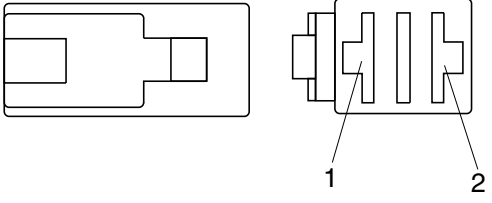
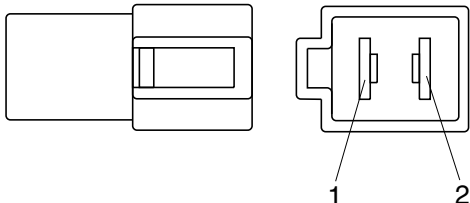
No. of pin	Receptacle connector (female)	Plug connector (male)
2	 <p style="text-align: center;">S810-002402</p>	 <p style="text-align: center;">S810-102402</p>

6) AMP ECONOSEAL CONNECTOR

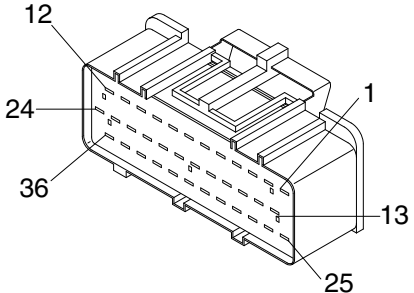
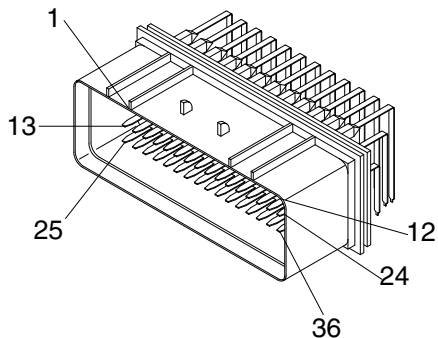
No. of pin	Receptacle connector (female)	Plug connector (male)
36	 <p style="text-align: center;">344111-1</p>	 <p style="text-align: center;">344108-1</p>

7) AMP TIMER CONNECTOR

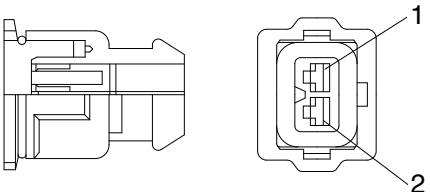
No. of pin	Receptacle connector (female)	Plug connector (male)
2	 <p style="text-align: center;">85202-1</p>	

8) AMP 040 MULTILOCK CONNECTOR

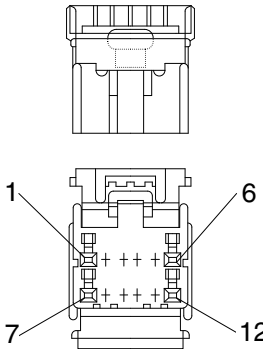
No. of pin	Receptacle connector (female)	Plug connector (male)
12	 <p style="text-align: right;">174045-2</p>	

9) AMP 070 MULTILOCK CONNECTOR

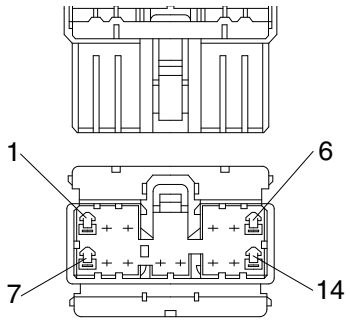
No. of pin	Receptacle connector (female)	Plug connector (male)
14	 <p style="text-align: right;">173852</p>	

10) AMP FASTIN - FASTON CONNECTOR

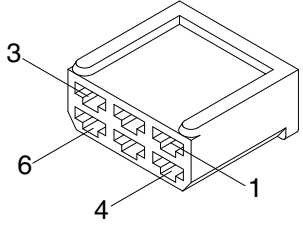
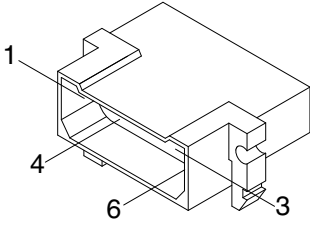
No. of pin	Receptacle connector (female)	Plug connector (male)
6	 <p style="text-align: right;">925276-0</p>	 <p style="text-align: right;">480003-9</p>

11) KET 090 CONNECTOR

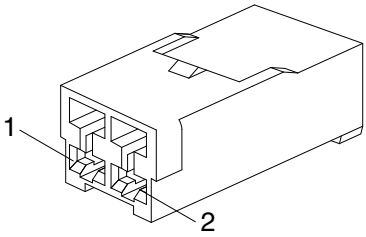
No. of pin	Receptacle connector (female)	Plug connector (male)
6	 <p style="text-align: right;">MG610070</p>	

12) KET 090 WP CONNECTORS

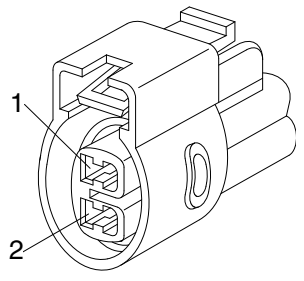
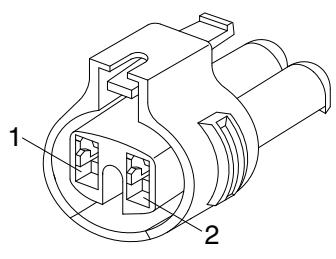
No. of pin	Receptacle connector (female)	Plug connector (male)
2	 <p style="text-align: right;">MG640605</p>	
2	 <p style="text-align: right;">MG640795</p>	

13) KET SDL CONNECTOR

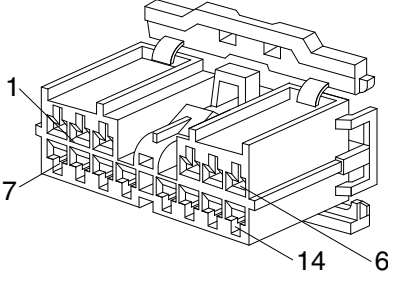
No. of pin	Receptacle connector (female)	Plug connector (male)
14	 <p>MG610406</p>	

14) DEUTSCH DT CONNECTORS

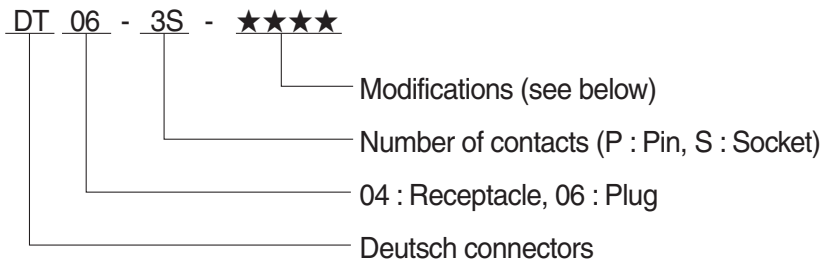

※ Modification

E003 : Standard end cap - gray

E004 : Color of connector to be black

E005 : Combination - E004 & E003

EP04 : End cap

EP06 : Combination P012 & EP04

P012 : Front seal enhancement - connectors color to black for 2, 3, 4 & 6pin

No. of pin	Receptacle connector (female)	Plug connector (male)
2	<p>DT06-2S</p>	<p>DT06-2P</p>
3	<p>DT06-3S</p>	<p>DT06-3P</p>
4	<p>DT06-4S</p>	<p>DT06-4P</p>

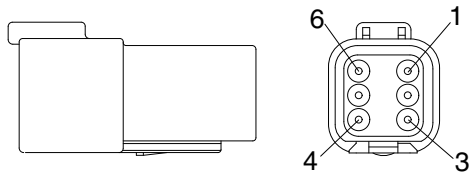
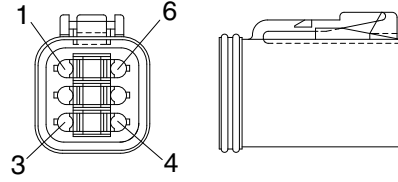
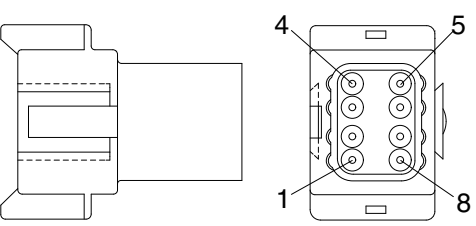
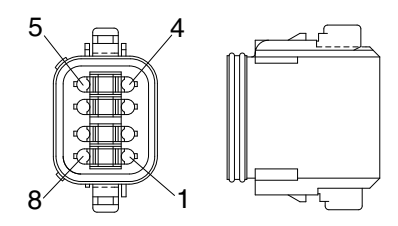
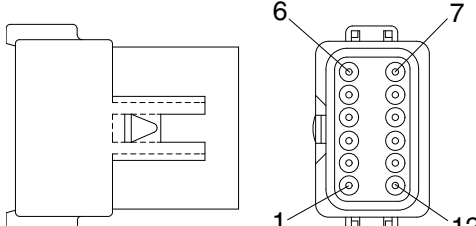
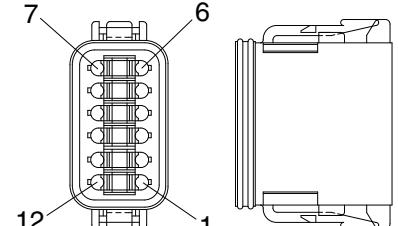
No. of pin	Receptacle connector (female)	Plug connector (male)
6	 <p style="text-align: right;">DT06-6S</p>	 <p style="text-align: right;">DT06-6P</p>
8	 <p style="text-align: right;">DT06-8S</p>	 <p style="text-align: right;">DT06-8P</p>
12	 <p style="text-align: right;">DT06-12S</p>	 <p style="text-align: right;">DT06-12P</p>

15) MOLEX 2CKTS CONNECTOR

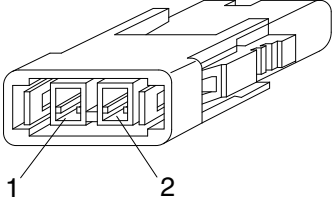
No. of pin	Receptacle connector (female)	Plug connector (male)
2	 <p data-bbox="703 680 836 710">35215-0200</p>	

16) ITT SWF CONNECTOR

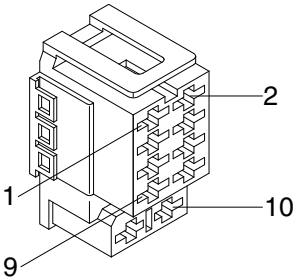
No. of pin	Receptacle connector (female)	Plug connector (male)
10	 <p data-bbox="699 1267 836 1296">SWF593757</p>	

17) MWP NMWP CONNECTOR

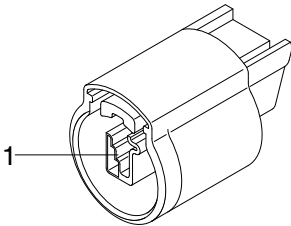
No. of pin	Receptacle connector (female)	Plug connector (male)
1	 <p data-bbox="691 1854 836 1883">NMWP01F-B</p>	

GROUP 6 FAULT CODES

1. MACHINE FAULT CODE

Fault code		Description
HCESPN	FMI	
101	3	Hydraulic oil temperature sensor circuit - voltage above normal or shorted to high source (or open circuit)
	4	Hydraulic oil temperature sensor circuit - voltage below normal or shorted to low source
105	0	Working pressure sensor data above normal range (or open circuit)
	1	Working pressure sensor data below normal range
	2	Working pressure sensor data error
	3	Engine intake manifold #1 temperature - voltage above normal
	4	Working pressure sensor circuit - voltage below normal, or shorted to low source
108	0	Travel oil pressure sensor data above normal range (or open circuit)
	1	Travel oil pressure sensor data below normal range
	2	Travel oil pressure sensor data error
	4	Travel oil pressure sensor circuit - voltage below normal or shorted to low source
122	0	Overload pressure sensor data above normal range (or open circuit)
	1	Overload pressure sensor data below normal range
	2	Overload pressure sensor data error
	3	Overload pressure sensor circuit - voltage below normal or shorted to low source
301	3	Fuel level sensor circuit - voltage above normal or shorted to high source (or open circuit)
	4	Fuel level sensor circuit - voltage below normal or shorted to low source
503	0	Brake pressure sensor data above normal range (or open circuit)
	1	Brake pressure sensor data below normal range
	2	Brake pressure sensor data error
	4	Brake pressure sensor data - voltage below normal or shorted to low source
505	0	Working brake pressure sensor data above normal range (or open circuit)
	1	Working brake pressure sensor data below normal range
	2	Working brake pressure sensor data error
	4	Working brake pressure sensor circuit - voltage below normal, or shorted to low source
530	0	Travel fwd pilot pressure sensor data above normal range (or open circuit)
	1	Travel fwd pilot pressure sensor data below normal range
	2	Travel fwd pilot pressure sensor data error
	4	Travel fwd pilot pressure sensor circuit - voltage below normal, or shorted to low source
	14	Travel fwd pilot pressure sensor circuit - special instructions
	16	Travel fwd pilot pressure sensor circuit - voltage valid but above normal operational range
701	4	Hour meter circuit - voltage below normal, or shorted to low source
705	0	MCU input voltage high
	1	MCU input voltage low
707	1	Alternator node I voltage low (or open circuit)
714	3	Acc. dial circuit - voltage above normal, or shorted to high source (or open circuit)
	4	Acc. dial circuit - voltage below normal, or shorted to low source
840	2	Cluster communication data error
841	2	ECM communication data error
IDSP		Water in fuel warning
Lo bat		Low battery warning

2. ENGINE FAULT CODE

Fault code		Description	
YANMAR SPN	FMI	Area	Status
522400	2	Crankshaft speed sensor	Crankshaft signal error
	5		No signal from crankshaft
522401	2	Camshaft speed sensor	Camshaft signal error
	5		No signal from camshaft
	7		Angle offset error
523249	5	Crankshaft speed sensor, Camshaft speed sensor	Crankshaft/camshaft, speed sensor non-input (simultaneous)
91	3	Accelerator sensor 1	Accelerator sensor 1 error (voltage high)
	4		Accelerator sensor 1 error (voltage low)
28	3	Accelerator sensor 2	Accelerator sensor 2 error (voltage high)
	4		Accelerator sensor 2 error (voltage low)
522624	7	Accelerator sensor 1 + 2	Dual accelerator sensor error (closed position)
522623	7		Dual accelerator sensor error (open position)
29	3	Accelerator sensor 3	Accelerator sensor 3 error (voltage high)
	4		Accelerator sensor 3 error (voltage low)
	8	Pulse sensor	Pulse accelerator sensor error (pulse communication)
28	0	Accelerator sensor 3	Accelerator sensor 3 error (foot pedal in open position)
	1		Accelerator sensor 3 error (foot pedal in closed position)
51	3	Intake throttle position sensor	Intake throttle position sensor error (voltage high)
	4		Intake throttle position sensor error (voltage low)
102	3	EGR low pressure side pressure sensor	ERG low pressure side pressure sensor error (excessive sensor output)
	4		ERG low pressure side pressure sensor error (insufficient sensor output)
	13		ERG low pressure side pressure sensor error (abnormal learning value)
	10		ERG low pressure side pressure sensor error (detected value error)
1209	3	EGR pressure sensor (high-pressure side)	ERG high pressure side pressure sensor error (excessive sensor output)
	4		ERG high pressure side pressure sensor error (insufficient sensor output)
	13		ERG high pressure side pressure sensor error (abnormal learning value)
	10		ERG high pressure side pressure sensor error (detected value error)
110	3	Engine coolant temperature sensor	Engine coolant temperature sensor error (excessive sensor output)
	4		Engine coolant temperature sensor error (insufficient sensor output)
	10		Engine coolant temperature sensor error (detected value error)
	0		Engine coolant temperature high (overheat)
172	3	Ambient air temperature sensor	Ambient air temperature sensor error (voltage high)
	4		Ambient air temperature sensor error (voltage low)

Fault code		Description	
YANMAR SPN	FMI	Area	Status
174	3	Fuel temperature sensor	Fuel temperature sensor error (voltage high)
	4		Fuel temperature sensor error (voltage low)
	0		Fuel temperature high
157	3	Rail pressure sensor	Rail pressure sensor error (voltage high)
	4		Rail pressure sensor error (voltage low)
3251	3	DPF differential pressure sensor	DPF differential pressure sensor error (excessive sensor output)
	4		DPF differential pressure sensor abnormal rise in differential pressure
	0		DPF differential pressure sensor error abnormal rise in differential pressure
	13		DPF differential pressure sensor error (abnormal learning value)
4795	31	DPF substrate/DPF differential pressure sensor	DPF substrate/DPF differential pressure sensor error (DPF substrate removal/DPF differential pressure sensor detected value error)
3609	3	DPF high pressure side pressure sensor	DPF high pressure side pressure sensor error (excessive sensor output)
	4		DPF high pressure side pressure sensor error (insufficient sensor output)
	10		DPF high pressure side pressure sensor error (detected value error)
3242	3	DPF intermediated temperature sensor	DPF inlet temperature sensor error (excessive sensor output)
	4		DPF inlet temperature sensor error (insufficient sensor output)
	10		DPF inlet temperature sensor error (detected value error)
	0		DPF inlet temperature sensor abnormal temperature (abnormally high)
3250	3	DPF intermediate temperature sensor	DPF intermediate temperature sensor error (excessive sensor output)
	4		DPF intermediate temperature sensor error (insufficient sensor output)
	10		DPF intermediate temperature sensor error (detected value error)
	1		DPF intermediate temperature sensor abnormal temperature (abnormally low)
108	3	Atmospheric pressure sensor	Atmospheric pressure sensor error (excessive sensor output)
	4		Atmospheric pressure sensor error (insufficient sensor output)
	10		Atmospheric pressure sensor error (characteristic error)
173	3	Exhaust manifold temperature sensor	Exhaust manifold temperature sensor error (excessive sensor output)
	4		Exhaust manifold temperature sensor error (insufficient sensor output)
	10		Exhaust manifold temperature sensor error (detected value error)
1485	7	Main relay	Main relay contact sticking
	2		Main relay early opening

Fault code		Description	
YANMAR SPN	FMI	Area	Status
522243	5	Starting aid relay	Starting aid relay disconnection
	6		Starting aid relay relay GND short circuit
654	5	Injector (No.1 cylinder)	Disconnection (injector-specific)
	6		Coil short circuit
	3		Short circuit
653	5	Injector (No.2 cylinder)	Disconnection (injector-specific)
	6		Coil short circuit
	3		Short circuit
652	5	Injector (No.3 cylinder)	Disconnection (injector-specific)
	11		Coil short circuit
	3		Short circuit
651	5	Injector (No.4 cylinder)	Disconnection (injector-specific)
	6		Coil short circuit
	3		Short circuit
4257	12	All injectors	Injector drive IC error
2797	6		Injector drive circuit (Bank1) short circuit (4TN: common circuit for No.1, No4 and all 3TN cylinders)
2798	6		Injector drive circuit (Bank2) short circuit (4TN: circuit for No.2 and 3 cylinders)
523462	13	Injector (correction value)	Injector (No.1 cylinder) correction value error
523463	13		Injector (No.2 cylinder) correction value error
523464	13		Injector (No.3 cylinder) correction value error
522465	13		Injector (No.4 cylinder) correction value error
522571	3	SCV (MPROP)	SCV (MPROP) L side VB short circuit
	6		SCV (MPROP) L side GND short circuit
633	3		SCV (MPROP) H side VB short circuit
	6		SCV (MPROP) H side GND short circuit
	5		SCV (MPROP) disconnection
522572	6		SCV (MPROP) drive current (high level)
	11		SCV (MPROP) pump overload error
157	0		Rail pressure error
	18	Rail pressure deviation error (low rail pressure)	
	15	Rail pressure deviation error (high rail pressure)	
	16	PLV open valve	
523469	0	PLV (common rail pressure limit valve)	Rail pressure fault (The times of PLV valve opening error)
523470	0		Rail pressure fault (The time of PLV valve opening error)
523489	0		Rail pressure fault (The actual rail pressure is too high during PRV limp home)
523498	9		Rail pressure fault (controlled rail pressure error after PLV valve opening)
523491	0	Rail pressure control	Rail pressure fault (injector B/F temperature error during PLV4 limp home)
523460	7		Rail pressure fault (operation time error during RPS limp home)

Fault code		Description		
YANMAR SPN	FMI	Area	Status	
190	16	Overspeed	Overspeed	
2950	5	Intake throttle drive circuit	No-load of throttle valve drive H bridge circuit	
	3		Power short circuit of throttle valve drive H bridge output 1	
	4		GND short circuit of throttle valve drive H bridge output 1	
	6		Overload on the drive H bridge circuit of throttle valve	
2951	3		VB power short circuit of throttle valve drive H bridge output 2	
	4		GND short circuit of throttle valve drive H bridge output 1	
2950	7		Throttle valve sticking (sticking open)	
2951	7		Throttle valves sticking (sticking closed)	
522596	9		CAN 2	TSC1 (SA1) reception timeout
522597	9			TSC1 (SA2) reception timeout
522599	9	Y_ECR1 reception timeout		
522600	9	Y_EC reception timeout		
522601	9	Y_RSS reception timeout		
237	31	VI_ reception timeout		
	13	VI_ reception data error		
522609	9	Y_ETCP1 reception timeout		
522618	9	EBC1 reception timeout		
522619	9	Y_DPFIF reception timeout		
522730	12	Immobilizer error (CAN communication)		
1202	2	Immobilizer error (system)		
522610	9	CAN 1		CAN 1 (for EGR): reception timeout from the EGR valve
522611	9			CAN 1 (for exhaust throttle): reception timeout
2791	0	EGR valve		EGR overvoltage error
	1			EGR low voltage error
	7		EGR feedback error	
	9		EGR ECM data error	
	12		Disconnection in EGR motor coils	
522579	12		Short circuit in EGR motor coils	
522580	12		EGR position sensor error	
522581	7		EGR valve sticking error	
522183	7		EGR initialization error	
522184	1		EGR high temperature thermistor error	
522617	1		EGR low temperature thermistor error	
522746	12		EGR target value out of range	
522747	12		Exhaust throttle	Exhaust throttle (voltage fault)
522748	12			Exhaust throttle (motor fault)
522749	12			Exhaust throttle (sensor system fault)
	12			Exhaust throttle (MPU fault)
522750	12	Exhaust throttle (PCB fault)		
522751	19	Exhaust throttle (CAN fault)		

Fault code		Description		
YANMAR SPN	FMI	Area	Status	
630	12	EEPROM	EEPROM memory deletion error	
522576	12		EEPROM memory reading error	
522578	12		EEPROM memory writing error	
522585	12	ECU internal fault	CY 146 SPI communication fault	
522588	12		Excessive voltage of supply 1	
522589	12		Insufficient voltage of supply 1	
522590	12		Sensor supply voltage error 1	
522591	12		Sensor supply voltage error 2	
522592	12		Sensor supply voltage error 3	
522744	4		Actuator drive circuit 1 short to ground	
522994	4		Actuator drive circuit 2 short to ground	
523471	6		Actuator drive circuit 3 short to ground	
523473	12		AD converter fault 1	
523474	12		AD converter fault 2	
523475	12		External monitoring IC and CPU fault 1	
523476	12		External monitoring IC and CPU fault 2	
523477	12		ROM fault	
523478	12		Shutoff path fault 1	
523479	12		Shutoff path fault 2	
523480	12		Shutoff path fault 3	
523481	12		Shutoff path fault 4	
523482	12		Shutoff path fault 5	
523483	12		Shutoff path fault 6	
523484	12		Shutoff path fault 7	
523485	12		Shutoff path fault 8	
523486	12		Shutoff path fault 9	
523487	12		Shutoff path fault 10	
523488	0		Recognition error of engine speed	
3059	5		Breather heater (optional parts for 4TNV86CT and 4TNV98CT)	Breather heater disconnection
	4			Breather heater short circuit (GND)
	3	Breather heater short circuit (VB)		
522323	0	Air cleaner switch	Air cleaner clogged alarm	
522329	0	Water separator switch	Water separator alarm	
167	5	Charge switch	Charge switch disconnection	
	1		Charge alarm	
100	4	Oil pressure switch	Oil pressure switch disconnection	
	1		Low oil pressure alarm	
522573	0	DPF	Excessive PM accumulation (method C)	
522574	0		Excessive PM accumulation (method P)	
522575	7		Regeneration failure (stationary regeneration failure)	
522577	11		Regeneration failure (stationary regeneration not performed)	
3250	0	DPF intermediate temperature sensor	DPF intermediate temperature sensor abnormal rise in temperature (post-injection malfunction)	

Fault code		Description	
YANMAR SPN	FMI	Area	Status
3720	16	DPF OP interface	Ash cleaning request 1
	0		Ash cleaning request 2
3719	16		Stationary regeneration standby
	0		Backup mode
3695	14		Reset regeneration is inhibited
3719	9		Regeneration failure (recovery regeneration failure)
	7		Recovery regeneration is inhibited