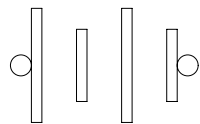
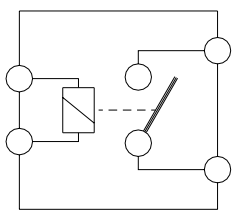
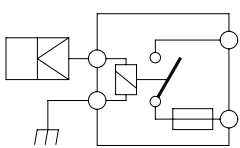
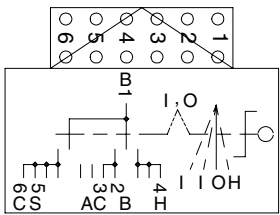
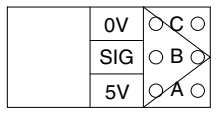
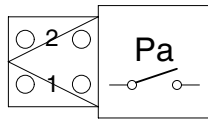
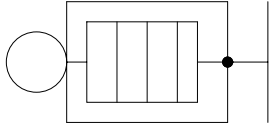
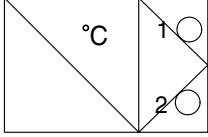
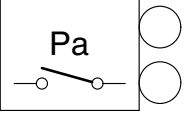
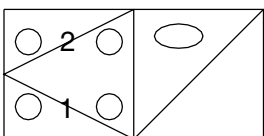
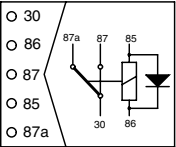
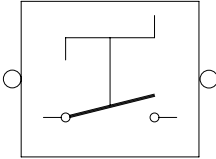
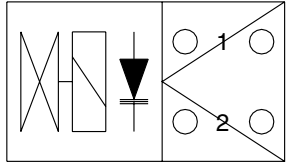
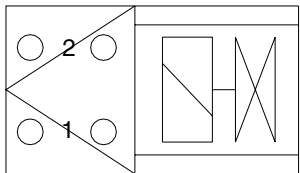
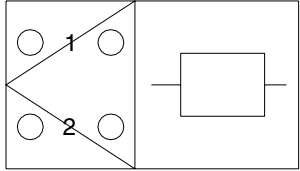
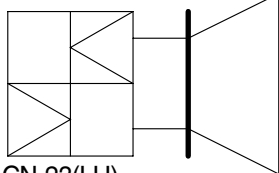
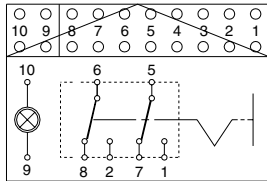
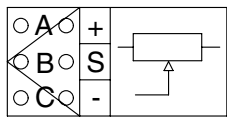
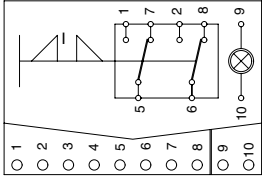
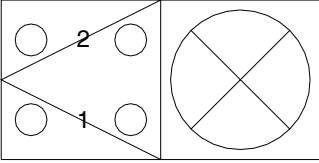
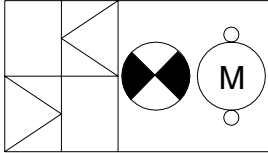
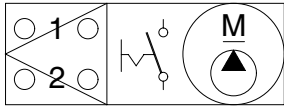
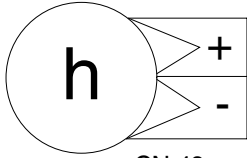
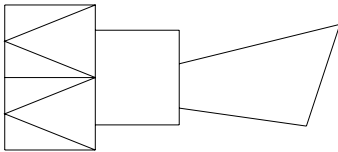

## GROUP 3 ELECTRICAL COMPONENT SPECIFICATION

Part name	Symbol	Specifications	Check
Battery		12V × 200Ah (4EA)	※ Check specific gravity 1.280 over : Over charged 1.280 ~ 1.250 : Normal 1.250 below : Recharging
Battery relay	 <p style="text-align: center;">CR-1</p>	Rated load : 24V 100A(continuity) 1000A(30seconds)	※ Check coil resistance(M4 to M4) Normal : About 50 Ω ※ Check contact Normal : ∞ Ω
Glow plug relay	 <p style="text-align: center;">CR-24</p>	24V 200A	※ Check contact Normal : 0.942 (For terminal 1-GND)
Start key	 <p style="text-align: center;">CS-2</p>	B-BR : 24V 1A B-ACC : 24V 10A B-ST : 24V 40A	※ Check contact OFF : ∞ Ω (For each terminal) ON : 0 Ω (For terminal 1-3 and 1-2) START : 0 Ω (For terminal 1-5)
Pressure switch (Travel, working)	 <p style="text-align: center;">CD-6 CD-7</p>	10kgf/cm <sup>2</sup> (N.C TYPE)	※ Check contact Normal : 0.1 Ω
Pressure switch (For overload, Swing)	 <p style="text-align: center;">CD-31</p>	3~6kgf/cm <sup>2</sup> (N.O TYPE)	※ Check contact Normal : ∞ Ω

Part name	Symbol	Specifications	Check
Glow plug	 CN-80	24V 200A	※ Check resistance 0.25 ~ 0.12 Ω
Temperature sensor (Hydraulic)	 CD-1	-	※ Check resistance 50°C : 804 Ω 80°C : 310 Ω 100°C : 180 Ω
Air cleaner pressure switch	 CD-10	-	※ Check contact High level : ∞ Ω Low level : 0 Ω
Fuel sender	 CD-2	-	※ Check resistance Full : 50 Ω      6/12 : 350 Ω 11/12 : 100 Ω    5/12 : 400 Ω 10/12 : 150 Ω    4/12 : 450 Ω 9/12 : 200 Ω     3/12 : 500 Ω 8/12 : 250 Ω     2/12 : 550 Ω 7/12 : 300 Ω     1/12 : 600 Ω Empty warning : 700 Ω
Relay	 CR-2 CR-3 CR-5 CR-7 CR-9 CR-13 CR-35 CR-36 CR-45 CR-46 CR-62	24V 16A	※ Check resistance Normal : About 160 Ω (For terminal 85-86) 0 Ω (For terminal 30-87a) ∞ Ω (For terminal 30-87)
Master switch		6~36V	※ Check disconnection Normal : 0.1 Ω

Part name	Symbol	Specifications	Check
Solenoid valve	 <p>CN-66 CN-68 CN-70 CN-88 CN-133 CN-137</p>	24V 1A	※ Check resistance Normal : 15~25 Ω (For terminal 1-2)
EPPR valve	 <p>CN-75</p>	700mA	※ Check resistance Normal : 15~25 Ω (For terminal 1-2)
Resistor	 <p>CN-47</p>	45 Ω 20W±5%	※ Check resistance Normal : 45 Ω
Speaker	 <p>CN-23(LH) CN-24(RH)</p>	20W	※ Check disconnection Normal : A few Ω
Switch (Locking type)	 <p>CS-23 CS-27 CS-50 CS-52 CS-54 CS-82 CS-83 CS-84</p>	24V 8A	※ Check contact Normal ON : 0 Ω (For terminal 1-5, 2-6) ∞ Ω (For terminal 5-7, 6-8) OFF : ∞ Ω (For terminal 1-5, 2-6) 0 Ω (For terminal 5-7, 6-8)
Accel dial	 <p>CN-142</p>	-	※ Check resist Normal : About 5k Ω (For terminal A-C) Normal : About 5V (For terminal A-C) : 2~4.5V (For terminal C-B)

Part name	Symbol	Specifications	Check
Switch	 <p>CS-67</p>	24V 8A	※ Check disconnection Normal : 1.0 Ω ON : 0 Ω (For terminal 1-5, 2-6) ∞ Ω (For terminal 5-7, 6-8) OFF : ∞ Ω (For terminal 1-5, 6-8) 0 Ω (For terminal 5-7, 6-8)
Head lamp, Work lamp, Room lamp, Cab lamp	 <p>CL-1 CL-3 CL-4 CL-5 CL-6 CL-8 CL-9 CL-10 CL-22 CL-23 CL-40 CL-41</p>	24V 70W (H3 Type) 24V 10W (Room lamp)	※ Check disconnection Normal : A few Ω
Beacon lamp	 <p>CL-7</p>	21V 70A (H1 type)	※ Check disconnection Normal : A few Ω
Fuel filler pump	 <p>CN-61</p>	24V 10A 50 l /min	※ Check resistance Normal : 1.0 Ω
Hour meter	 <p>CN-48</p>	16~32V	※ Check operation Supply power(24V) to terminal No.2 and connect terminal No.1 and ground
Horn	 <p>CN-20 CN-25</p>	DC22~28V 2A	※ Check operation Supply power(24V) to each terminal and connect ground.

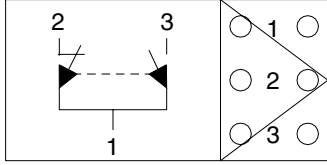
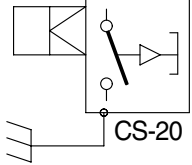
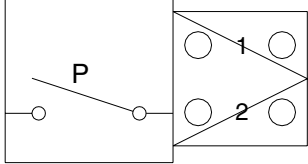
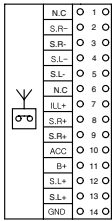
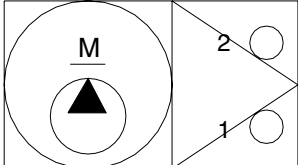
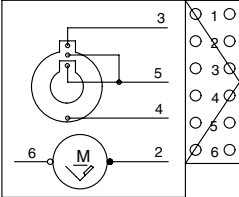
Part name	Symbol	Specifications	Check
Safety switch 1	 <p>CS-4</p>	24V 15A (N.C TYPE)	※ Check contact Normal : 0 Ω (For terminal 1-2) ∞ Ω (For terminal 1-3) Operating : ∞ Ω (For terminal 1-2) 0 Ω (For terminal 1-3)
Safety switch 2	 <p>CS-20</p>	24V (N.C TYPE)	※ Check contact Normal : 0 Ω (One pin to ground)
Receiver dryer	 <p>CN-29</p>	24V 2.5A	※ Check contact Normal : ∞ Ω
Cassette radio	 <p>CN-27</p>	24V 2A	※ Check voltage 20~25V (For terminal 10-14, 11-14)
Washer pump	 <p>CN-22</p>	24V 3.8A	※ Check contact Normal : 10.7 Ω (For terminal 1-2)
Wiper motor	 <p>CN-21</p>	24V 2A	※ Check disconnection Normal : 7 Ω (For terminal 2-6)

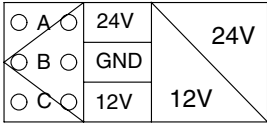
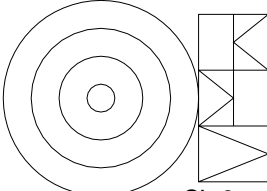
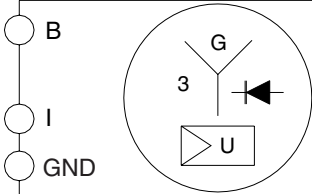
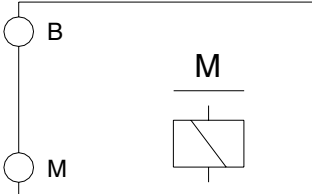
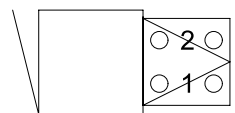
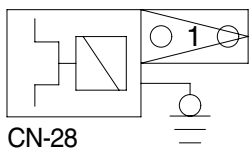
Part name	Symbol	Specifications	Check
DC/DC Converter	 <p>CN-138</p>	12V 3A	24V(A-B) 12V (B-C)
Cigar lighter	 <p>CL-2</p>	24V 5A 1.4W	※ Check coil resistance Normal : About 1M Ω ※ Check contact Normal : ∞ Ω Operating time : 5~15sec
Alternator	 <p>CN-74</p>	24V 55A	※ Check contact Normal : 0 Ω (For terminal B <sup>+</sup> -I) Normal : 24~27.5V
Starter	 <p>CN-45</p>	Delco Remy 28MT 24V	※ Check contact Normal : 0.1 Ω
Travel alarm	 <p>CN-81</p>	24V 0.5A	※ Check contact Normal : 5.2 Ω
Aircon compressor	 <p>CN-28</p>	24V 79W	※ Check contact Normal : 13.4 Ω

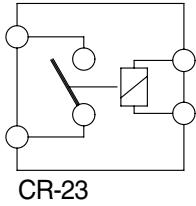
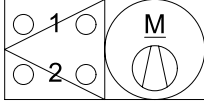
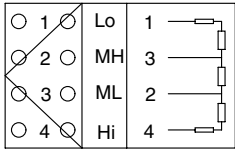
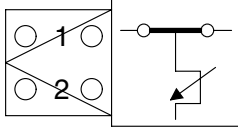
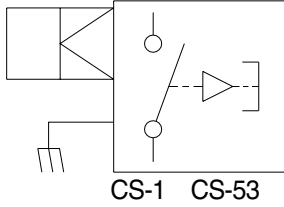
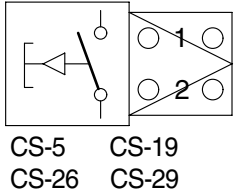
Part name	Symbol	Specifications	Check
Start relay	 <p>CR-23</p>	24V 300A	※ Check contact Normal : 0.94 Ω (For terminal 1-2)
Blower motor		24V 9.5A	※ Check resistance Normal : 2.5 Ω (For terminal 1-2)
Aircon resistor		-	※ Check resistance Normal : 1.12 Ω (For terminal 4-2) 2.07 Ω (For terminal 2-3) 3.17 Ω (For terminal 3-1)
Duct sensor		1°C OFF 4°C ON	※ Check resistance Normal : 0 Ω (For terminal 1-2), the atmosphere temp : Over 4°C
Switch (Door, wiper cut)	 <p>CS-1 CS-53</p>	24V 2W	※ Check resistance Normal : About 5M Ω
Switch (Power max, one touch decal, horn, breaker)	 <p>CS-5 CS-19 CS-26 CS-29</p>	24V 6A	※ Check resistance Normal : ∞ Ω

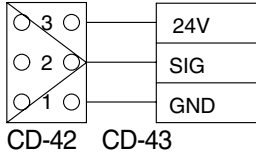
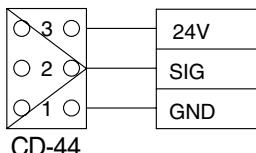
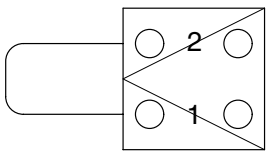
Part name	Symbol	Specifications	Check
Transducer	 <p>CD-42 CD-43</p>	500bar	0bar : 1V(For terminal 1-2) 500bar : 5V(For terminal 1-2)
Transducer	 <p>CD-44</p>	50bar	0bar : 1V(For terminal 1-2) 50bar : 5V(For terminal 1-2)
Fusible link	 <p>CN-60 CN95</p>	60A	※ Check disconnection Normal : 0 Ω (Connect ring terminal and check resist between terminal 1 and 2)