

SECTION 1 GENERAL



| | |
|------------------------------|-----|
| Group 1 Safety Hints | 1-1 |
| Group 2 Specifications | 1-9 |

SECTION 1 GENERAL

GROUP 1 SAFETY

FOLLOW SAFE PROCEDURE

Unsafe work practices are dangerous. Understand service procedure before doing work; Do not attempt shortcuts.

WEAR PROTECTIVE CLOTHING

Wear close fitting clothing and safety equipment appropriate to the job.

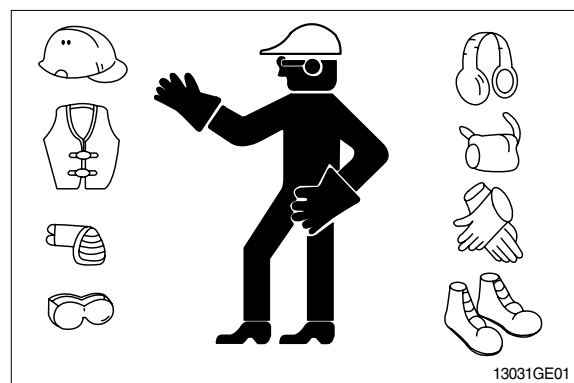

WARN OTHERS OF SERVICE WORK

Unexpected machine movement can cause serious injury.

Before performing any work on the excavator, attach a 「Do Not Operate」 tag on the right side control lever.

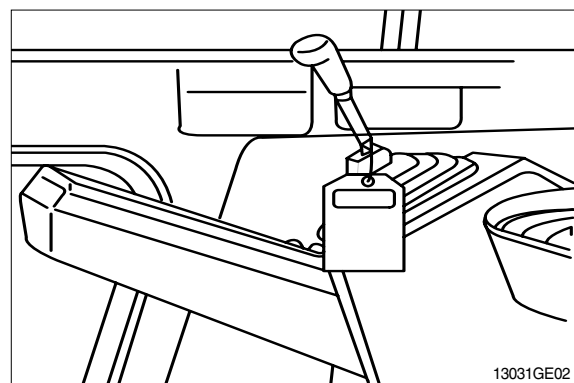

USE HANDHOLDS AND STEPS

Falling is one of the major causes of personal injury. When you get on and off the machine, always maintain a three point contact with the steps and handrails and face the machine. Do not use any controls as handholds.

Never jump on or off the machine. Never mount or dismount a moving machine.

Be careful of slippery conditions on platforms, steps, and handrails when leaving the machine.

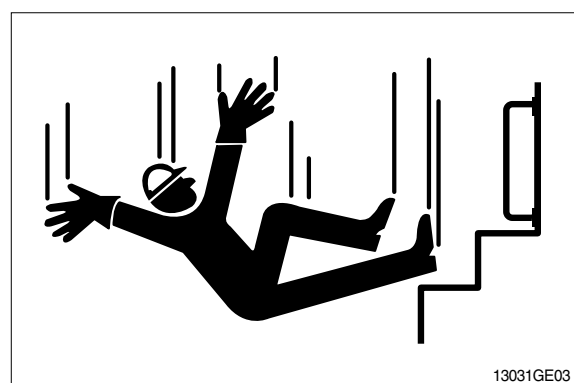

PREPARE FOR EMERGENCIES

Be prepared if a fire starts.

Keep a first aid kit and fire extinguisher handy.

Keep emergency numbers for doctors, ambulance service, hospital, and fire department near your telephone.

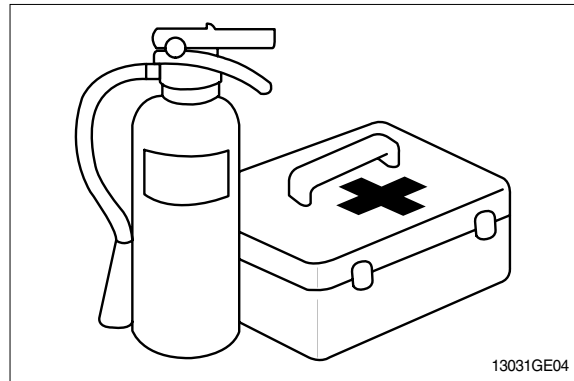

PROTECT AGAINST FLYING DEBRIS

Guard against injury from flying pieces of metal or debris; Wear goggles or safety glasses.

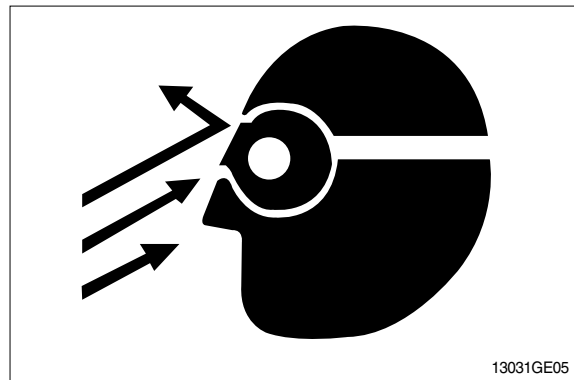

PROTECT AGAINST NOISE

Prolonged exposure to loud noise can cause impairment or loss of hearing.

Wear a suitable hearing protective device such as earmuffs or earplugs to protect against objectionable or uncomfortable loud noises.

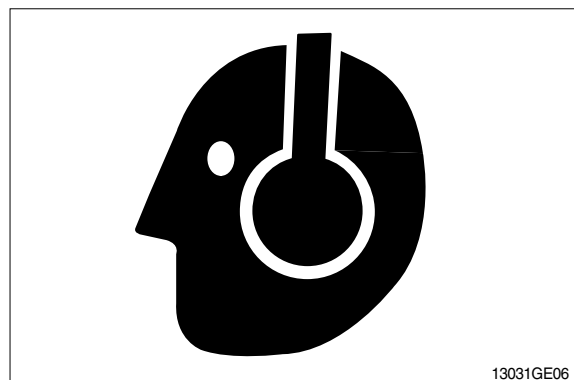

AVOID POWER LINES

Serious injury or death can result from contact with electric lines.

Never move any part of the machine or load closer to electric line than 3m(10ft) plus twice the line insulator length.

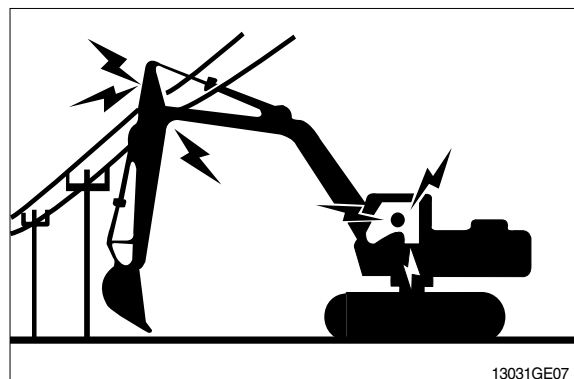

KEEP RIDERS OFF EXCAVATOR

Only allow the operator on the excavator. Keep riders off.

Riders on excavator are subject to injury such as being struck by foreign objects and being thrown off the excavator. Riders also obstruct the operator's view resulting in the excavator being operated in an unsafe manner.

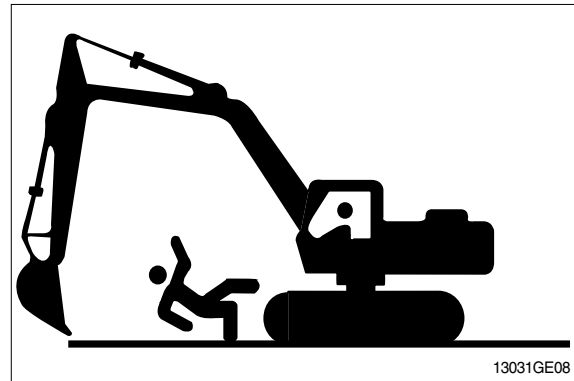

MOVE AND OPERATE MACHINE SAFELY

Bystanders can be run over. Know the location of bystanders before moving, swinging, or operating the machine.

Always keep the travel alarm in working condition. It warns people when the excavator starts to move.

Use a signal person when moving, swinging, or operating the machine in congested areas. Coordinate hand signals before starting the excavator.

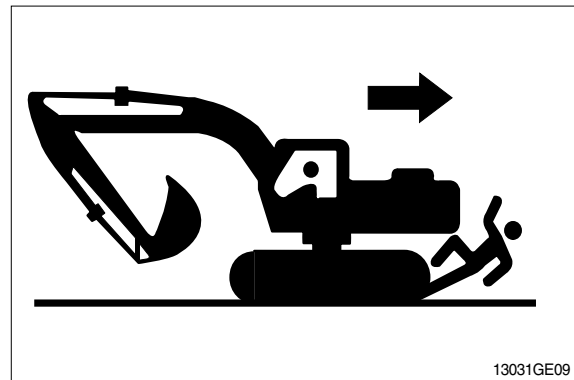

OPERATE ONLY FROM OPERATOR'S SEAT

Avoid possible injury machine damage. Do not start engine by shorting across starter terminals.

NEVER start engine while standing on ground. Start engine only from operator's seat.



PARK MACHINE SAFELY

Before working on the machine:

- Park machine on a level surface.
- Lower bucket to the ground.
- Turn auto idle switch off.
- Run engine at 1/2 speed without load for 2 minutes.
- Turn key switch to OFF to stop engine.
Remove key from switch.
- Move pilot control shutoff lever to locked position.
- Allow engine to cool.

SUPPORT MACHINE PROPERLY

Always lower the attachment or implement to the ground before you work on the machine. If you must work on a lifted machine or attachment, securely support the machine or attachment.

Do not support the machine on cinder blocks, hollow tiles, or props that may crumble under continuous load. Do not work under a machine that is supported solely by a jack. Follow recommended procedures in this manual.

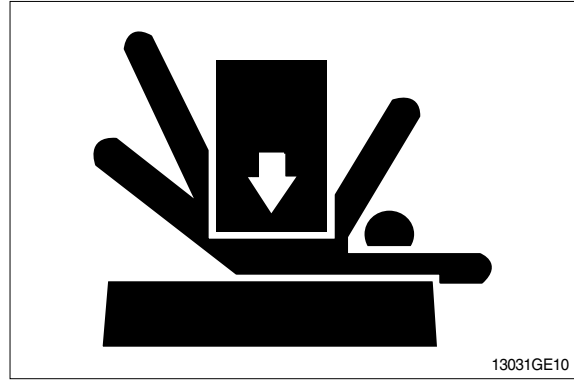

SERVICE COOLING SYSTEM SAFELY

Explosive release of fluids from pressurized cooling system can cause serious burns.

Shut off engine. Only remove filler cap when cool enough to touch with bare hands.

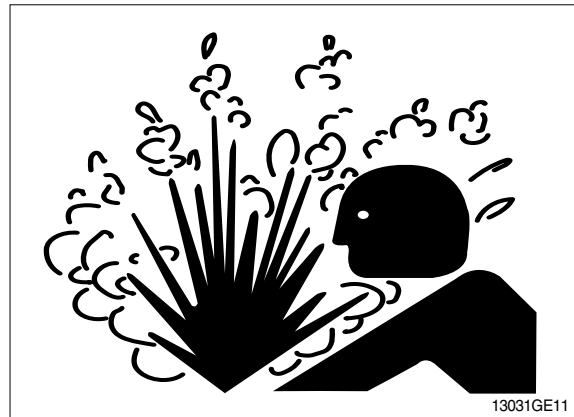

HANDLE FLUIDS SAFELY-AVOID FIRES

Handle fuel with care; It is highly flammable. Do not refuel the machine while smoking or when near open flame or sparks. Always stop engine before refueling machine.

Fill fuel tank outdoors.



Store flammable fluids away from fire hazards. Do not incinerate or puncture pressurized containers.

Make sure machine is clean of trash, grease, and debris.

Do not store oily rags; They can ignite and burn spontaneously.

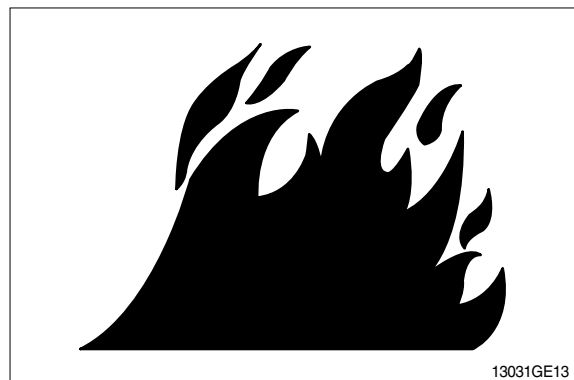

BEWARE OF EXHAUST FUMES

Prevent asphyxiation. Engine exhaust fumes can cause sickness or death.

If you must operate in a building, be positive there is adequate ventilation. Either use an exhaust pipe extension to remove the exhaust fumes or open doors and windows to bring enough outside air into the area.

REMOVE PAINT BEFORE WELDING OR HEATING

Avoid potentially toxic fumes and dust.

Hazardous fumes can be generated when paint is heated by welding, soldering, or using a torch.

Do all work outside or in a well ventilated area. Dispose of paint and solvent properly.

Remove paint before welding or heating:

- If you sand or grind paint, avoid breathing the dust. Wear an approved respirator.
- If you use solvent or paint stripper, remove stripper with soap and water before welding. Remove solvent or paint stripper containers and other flammable material from area. Allow fumes to disperse at least 15 minutes before welding or heating.

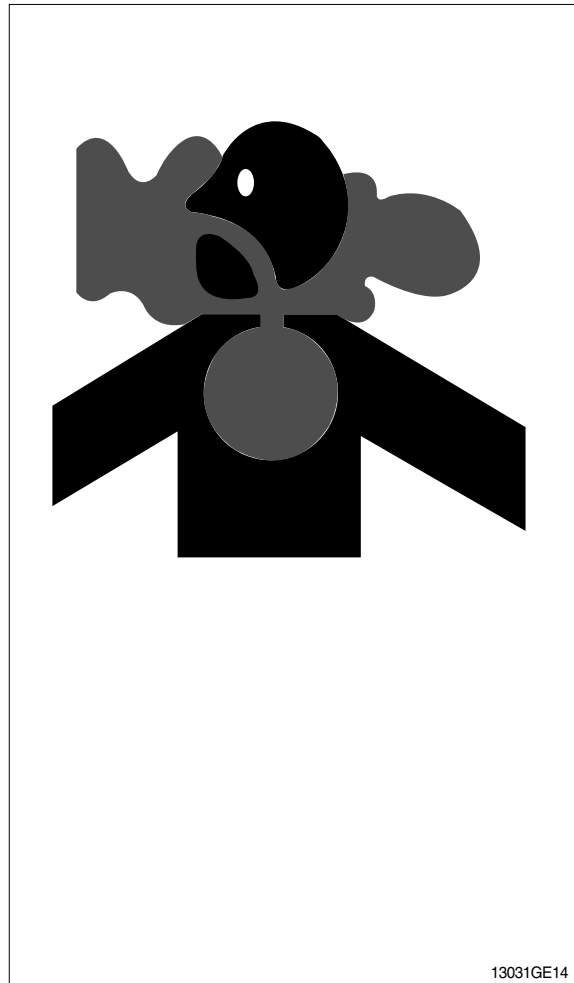

ILLUMINATE WORK AREA SAFELY

Illuminate your work area adequately but safely. Use a portable safety light for working inside or under the machine. Make sure the bulb is enclosed by a wire cage. The hot filament of an accidentally broken bulb can ignite spilled fuel or oil.



SERVICE MACHINE SAFELY

Tie long hair behind your head. Do not wear a necktie, scarf, loose clothing or necklace when you work near machine tools or moving parts. If these items were to get caught, severe injury could result.

Remove rings and other jewelry to prevent electrical shorts and entanglement in moving parts.

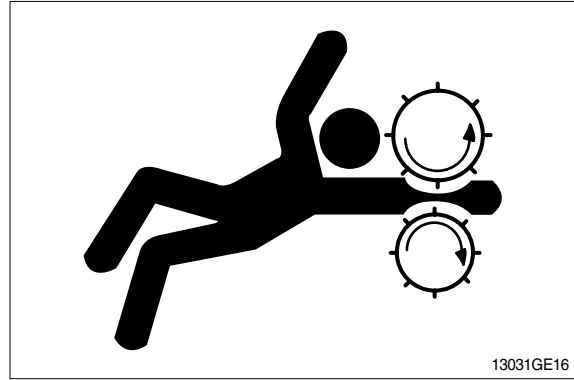

STAY CLEAR OF MOVING PARTS

Entanglements in moving parts can cause serious injury.

To prevent accidents, use care when working around rotating parts.

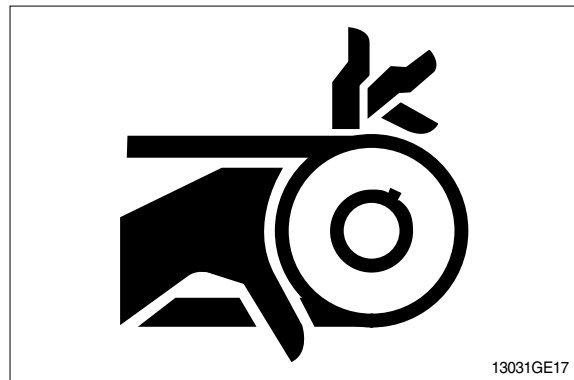

AVOID HIGH PRESSURE FLUIDS

Escaping fluid under pressure can penetrate the skin causing serious injury.

Avoid the hazard by relieving pressure before disconnecting hydraulic or other lines. Tighten all connections before applying pressure.

Search for leaks with a piece of cardboard. Protect hands and body from high pressure fluids.

If an accident occurs, see a doctor immediately. Any fluid injected into the skin must be surgically removed within a few hours or gangrene may result.

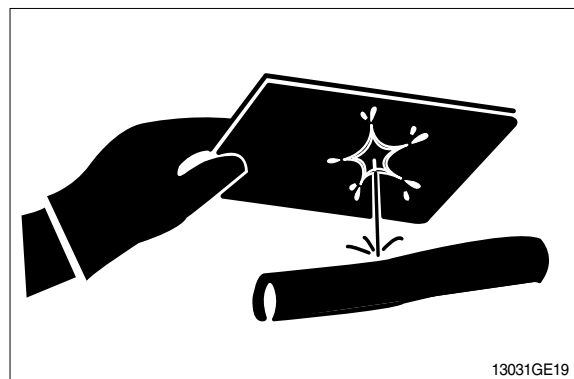

AVOID HEATING NEAR PRESSURIZED FLUID LINES

Flammable spray can be generated by heating near pressurized fluid lines, resulting in severe burns to yourself and bystanders. Do not heat by welding, soldering, or using a torch near pressurized fluid lines or other flammable materials.

Pressurized lines can be accidentally cut when heat goes beyond the immediate flame area. Install fire resisting guards to protect hoses or other materials.



PREVENT BATTERY EXPLOSIONS

Keep sparks, lighted matches, and flame away from the top of battery. Battery gas can explode.

Never check battery charge by placing a metal object across the posts. Use a volt-meter or hydrometer.

Do not charge a frozen battery; It may explode. Warm battery to 16°C (60°F).



PREVENT ACID BURNS

Sulfuric acid in battery electrolyte is poisonous. It is strong enough to burn skin, eat holes in clothing, and cause blindness if splashed into eyes.

Avoid the hazard by:

1. Filling batteries in a well-ventilated area.
2. Wearing eye protection and rubber gloves.
3. Avoiding breathing fumes when electrolyte is added.
4. Avoiding spilling or dripping electrolyte.
5. Use proper jump start procedure.

If you spill acid on yourself:

1. Flush your skin with water.
2. Apply baking soda or lime to help neutralize the acid.
3. Flush your eyes with water for 10-15 minutes. Get medical attention immediately.

If acid is swallowed:

1. Drink large amounts of water or milk.
2. Then drink milk of magnesia, beaten eggs, or vegetable oil.
3. Get medical attention immediately.

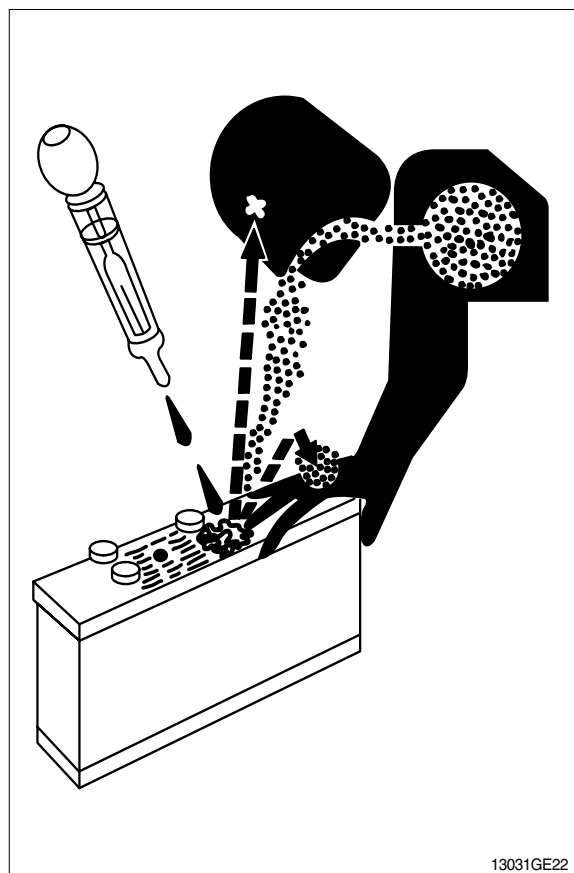

USE TOOLS PROPERLY

Use tools appropriate to the work. Makeshift tools, parts, and procedures can create safety hazards.

Use power tools only to loosen threaded tools and fasteners.

For loosening and tightening hardware, use the correct size tools. DO NOT use U.S. measurement tools on metric fasteners. Avoid bodily injury caused by slipping wrenches.

Use only recommended replacement parts.(See Parts catalogue.)

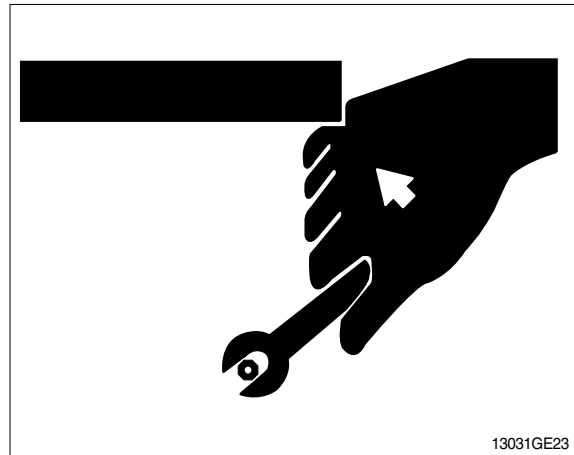

DISPOSE OF FLUIDS PROPERLY

Improperly disposing of fluids can harm the environment and ecology. Before draining any fluids, find out the proper way to dispose of waste from your local environmental agency.

Use proper containers when draining fluids. Do not use food or beverage containers that may mislead someone into drinking from them.

DO NOT pour oil into the ground, down a drain, or into a stream, pond, or lake. Observe relevant environmental protection regulations when disposing of oil, fuel, coolant, brake fluid, filters, batteries, and other harmful waste.

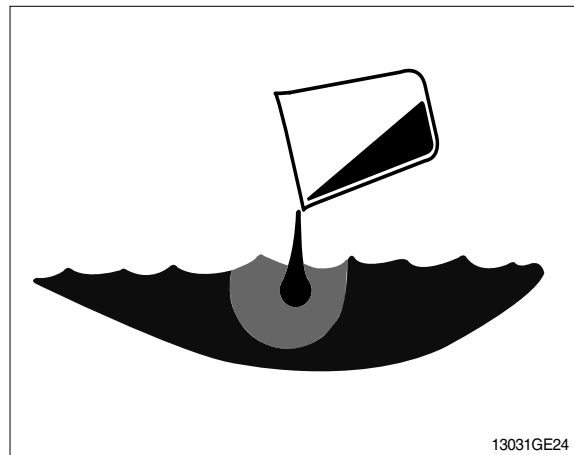

REPLACE SAFETY SIGNS

Replace missing or damaged safety signs. See the machine operator's manual for correct safety sign placement.

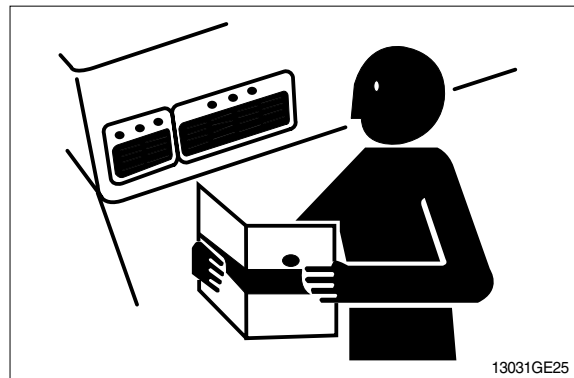

LIVE WITH SAFETY

Before returning machine to customer, make sure machine is functioning properly, especially the safety systems. Install all guards and shields.

GROUP 2 SPECIFICATIONS

1. MAJOR COMPONENT

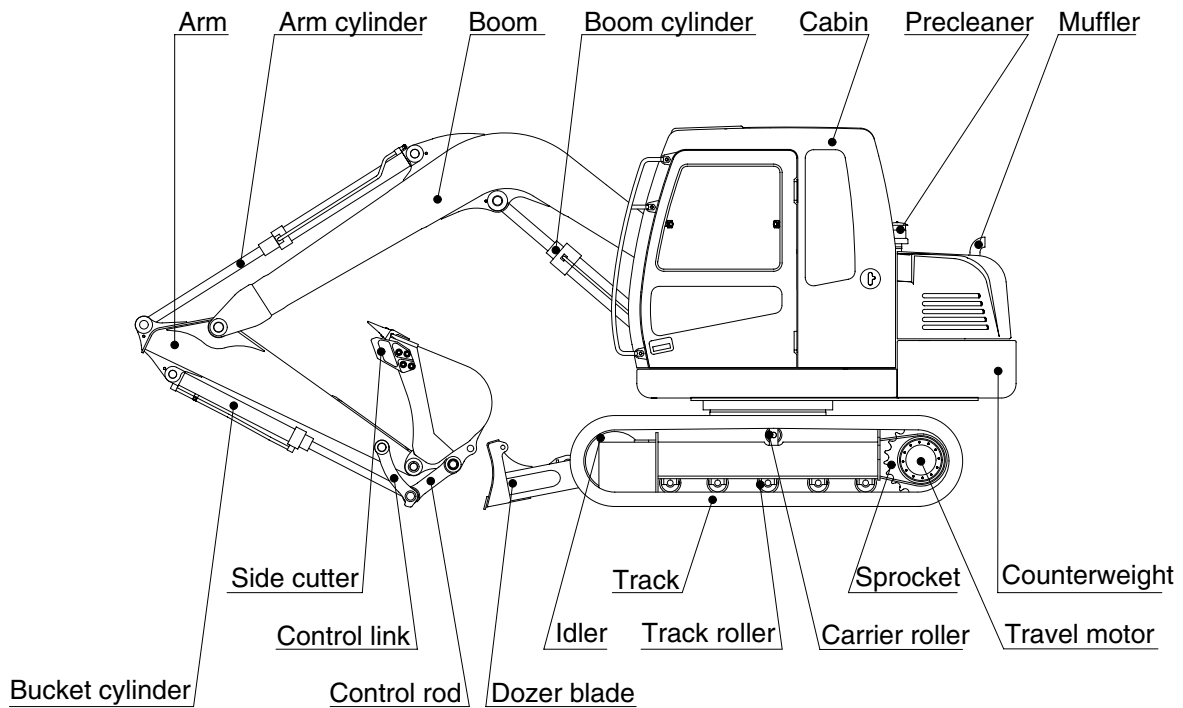
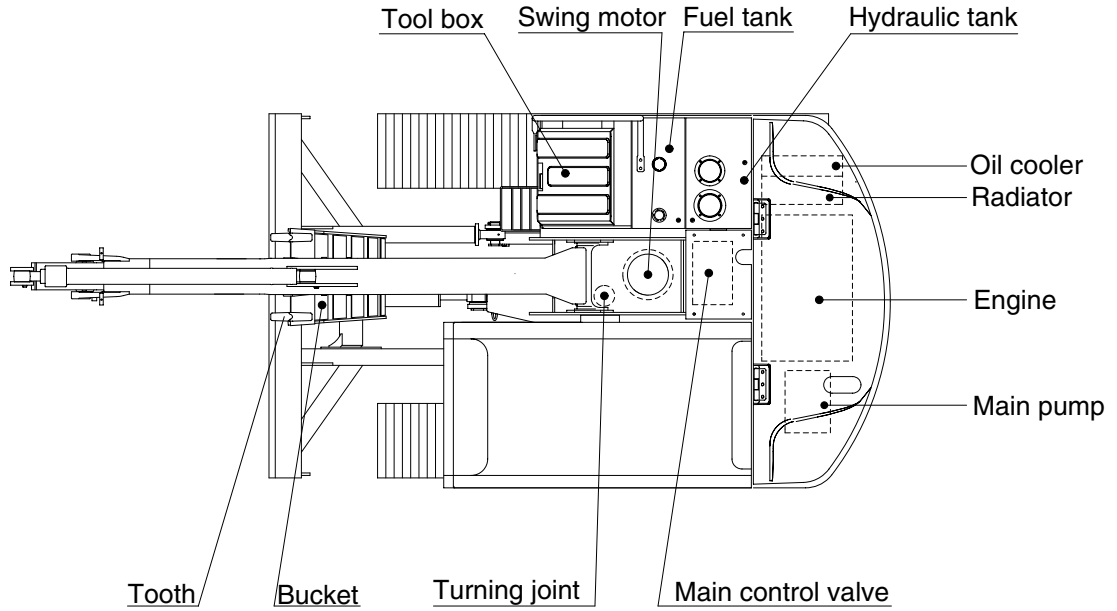

7072SP01

2. SPECIFICATIONS

1) R80

(1) 3.7m(12' 2") MONO BOOM, 1.67m(5' 6") ARM AND FRONT DOZER BLADE

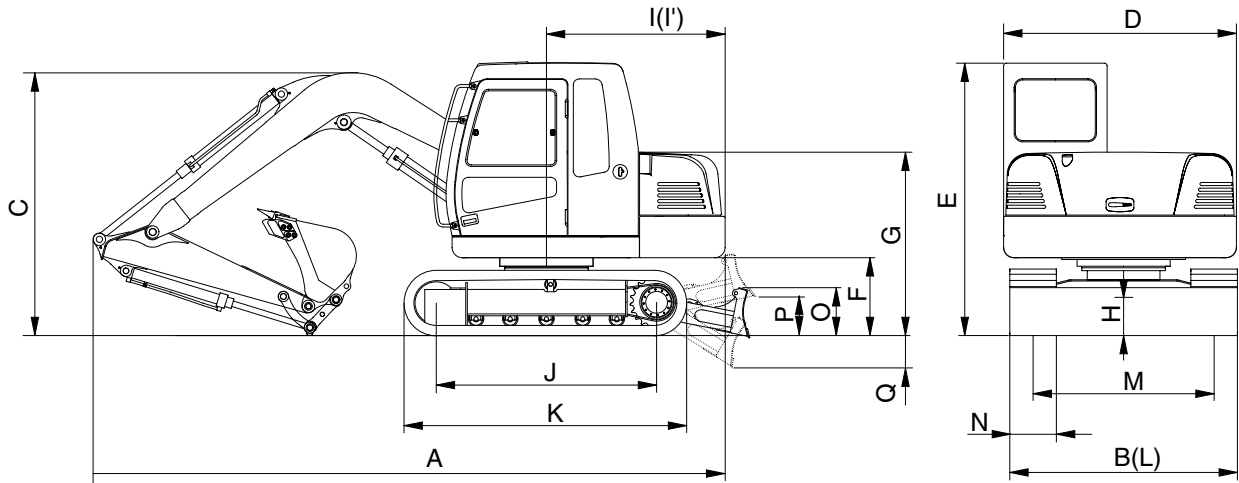

7707203A

| Description | | Unit | Specification |
|---------------------------------------|----|-----------------------------------|---------------|
| Operating weight | | kg(lb) | 7900(17555) |
| Bucket capacity(SAE heaped), standard | | m ³ (yd ³) | 0.28(0.25) |
| Overall length | A | mm(ft-in) | 6325(20' 9") |
| Overall width, with 450mm shoe | B | | 2260(7' 5") |
| Overall height of boom | C | | 2605(8' 7") |
| Superstructure width | D | | 2250(7' 5") |
| Overall height | E | | 2650(8' 8") |
| Ground clearance of counterweight | F | | 755(2' 6") |
| Engine cover height | G | | 1775(5' 10") |
| Minimum ground clearance | H | | 360(1' 2") |
| Rear-end distance | I | | 1727(5' 8") |
| Rear-end swing radius | I' | | 1750(5' 9") |
| Distance between tumblers | J | | 2130(6' 12") |
| Undercarriage length | K | | 2724(8' 11") |
| Undercarriage width | L | | 2200(7' 3") |
| Track gauge | M | | 1750(5' 9") |
| Track shoe width, standard | N | | 450(1' 6") |
| Height of blade | O | | 460(1' 6") |
| Ground clearance of blade up | P | | 400(1' 4") |
| Depth of blade down | Q | | 280(0' 11") |
| Travel speed(Low/high) | | | km/hr(mph) |
| Swing speed | | rpm | 12.0 |
| Gradeability | | Degree(%) | 30(58) |
| Ground pressure(450mm shoe) | | kgf/cm ² (psi) | 0.37(5.26) |

3. WORKING RANGE

1) R80

(1) 3.7m(12' 2") MONO BOOM

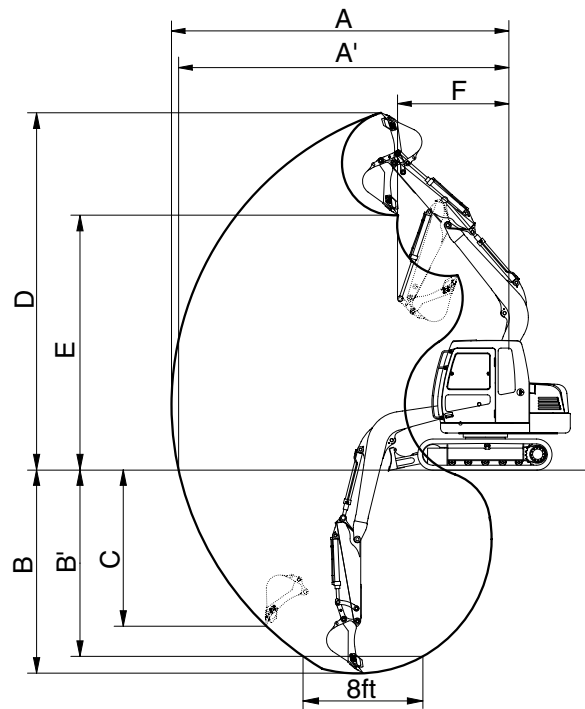

7072SP03

| Description | | 1.67m(5' 6") Arm |
|---------------------------------|-----|------------------|
| Max digging reach | A | 6330mm (20' 9") |
| Max digging reach on ground | A' | 6190mm (20' 4") |
| Max digging depth | B | 4150mm (13' 7") |
| Max digging depth (8ft level) | B' | 3810mm (12' 6") |
| Max vertical wall digging depth | C | 3200mm (10' 6") |
| Max digging height | D | 7260mm (23'10") |
| Max dumping height | E | 5170mm (17' 0") |
| Min swing radius | F | 1750mm (5' 9") |
| Bucket digging force | SAE | 44.1 kN |
| | | 4500 kgf |
| | | 9920 lbf |
| | ISO | 51.0 kN |
| | | 5200 kgf |
| | | 11460 lbf |
| Arm digging force | SAE | 38.2 kN |
| | | 3900 kgf |
| | | 8600 lbf |
| | ISO | 39.2 kN |
| | | 4000 kgf |
| | | 8820 lbf |

4. WEIGHT









1) R80

| Item | kg | lb |
|---|------|------|
| Upperstructure assembly | 3750 | 8270 |
| Main frame weld assembly | 820 | 1810 |
| Engine assembly | 550 | 1120 |
| Main pump assembly | 50 | 110 |
| Main control valve assembly | 60 | 130 |
| Swing motor assembly | 80 | 170 |
| Hydraulic oil tank assembly | 120 | 260 |
| Fuel tank assembly | 80 | 170 |
| Counterweight | 540 | 1190 |
| Cab assembly | 310 | 680 |
| Lower chassis assembly | 2820 | 6220 |
| Track frame weld assembly | 980 | 2160 |
| Swing bearing | 140 | 310 |
| Travel motor assembly | 90 | 200 |
| Turning joint | 30 | 60 |
| Track recoil spring(2EA) | 120 | 260 |
| Idler(2EA) | 130 | 290 |
| Sprocket(2EA) | 50 | 110 |
| Carrier roller(2EA) | 20 | 40 |
| Track roller(10EA) | 160 | 360 |
| Track-chain assembly(450mm standard triple grouser shoe, 2EA) | 810 | 1790 |
| Dozer blade assembly | 330 | 730 |
| Front attachment assembly(3.7m boom, 1.67m arm, 0.32m ³ SAE heaped bucket) | 1230 | 2710 |
| 3.7m boom assembly | 490 | 1080 |
| 1.67m arm assembly | 200 | 440 |
| 0.32m ³ SAE heaped bucket | 245 | 540 |
| Boom cylinder assembly | 120 | 260 |
| Arm cylinder assembly | 80 | 180 |
| Bucket cylinder assembly | 50 | 110 |
| Dozer blade cylinder | 50 | 110 |
| Bucket control link assembly | 60 | 130 |









5. LIFTING CAPACITIES

1) ROBEX 80

(1) 3.7m (12' 2") boom, 1.67m (5' 6") arm equipped with 0.32m³ (SAE heaped) bucket and 450mm (18") triple grouser shoe and dozer blade up with 400kg (890lb) counterweight.

| Load point height | | Load radius | | | | | | At max. reach | | |
|--------------------|----------|---|---|---|---|---|--|---|---|----------------|
| | | 1.5m(5ft) | | 3.0m(10ft) | | 4.5m(15ft) | | Capacity | | Reach |
| | |  |  |  |  |  |  |  |  | m(ft) |
| 4.5m (15.0ft) | kg lb | | | *1800 *3970 | *1800 *3970 | | | 1130 2490 | 1020 2250 | 5.06 (16.6) |
| 3.0m (10.0ft) | kg lb | *3890 *8580 | *3890 *8580 | *2370 *5220 | *2370 *5220 | 1350 2980 | 1220 2690 | 850 1870 | 760 1680 | 5.75 (18.9) |
| 1.5m (5.0ft) | kg lb | | | 2490 5490 | 2190 4830 | 1260 2780 | 1130 2490 | 760 1680 | 680 1500 | 5.95 (19.5) |
| Ground Line | kg lb | | | 2300 5070 | 2000 4410 | 1180 2600 | 1060 2340 | 800 1760 | 720 1590 | 5.70 (18.7) |
| -1.5m (-5.0ft) | kg lb | *4810 *10600 | *4810 *10600 | 2260 4980 | 1970 4340 | 1170 2580 | 1040 2290 | 1030 2270 | 920 2030 | 4.93 (16.2) |
| -3.0m (-10.0ft) | kg lb | *4000 *8820 | *4000 *8820 | *2360 *5200 | 2060 4540 | | | | | |

(2) 3.7m (12' 2") boom, 1.67m (5' 6") arm equipped with 0.32m³ (SAE heaped) bucket and 450mm (18") triple grouser shoe and dozer blade down with 400kg (890lb) counterweight.

| Load point height | | Load radius | | | | | | At max. reach | | |
|--------------------|----------|---|---|---|---|---|--|---|---|----------------|
| | | 1.5m(5ft) | | 3.0m(10ft) | | 4.5m(15ft) | | Capacity | | Reach |
| | |  |  |  |  |  |  |  |  | m(ft) |
| 4.5m (15.0ft) | kg lb | | | *1800 *3970 | *1800 *3970 | | | *1680 *3700 | 1090 2400 | 5.06 (16.6) |
| 3.0m (10.0ft) | kg lb | *3890 *8580 | *3890 *8580 | *2370 *5220 | *2370 *5220 | *1930 *4250 | 1300 2870 | *1710 *3770 | 820 1810 | 5.75 (18.9) |
| 1.5m (5.0ft) | kg lb | | | *3330 *7340 | 2350 5180 | *2230 *4920 | 1210 2670 | *1760 *3880 | 740 1630 | 5.95 (19.5) |
| Ground Line | kg lb | | | *3820 *8420 | 2160 4760 | *2430 *5360 | 1140 2510 | *1810 *3990 | 770 1700 | 5.70 (18.7) |
| -1.5m (-5.0ft) | kg lb | *4810 *10600 | *4810 *10600 | *3580 *7890 | 2130 4700 | *2230 *4920 | 1120 2470 | *1790 *3950 | 990 2180 | 4.93 (16.2) |
| -3.0m (-10.0ft) | kg lb | *4000 *8820 | *4000 *8820 | *2360 *5200 | 2220 4980 | | | | | |

- Note
1. Lifting capacity are based on SAE J1097 and ISO 10567.
 2. Lifting capacity of the ROBEX series does not exceed 75% of tipping load with the machine on firm, level ground or 87% of full hydraulic capacity.
 3. The load point is a hook located on the back of the bucket.
 4. *indicates load limited by hydraulic capacity.

6. BUCKET SELECTION GUIDE

1) GENERAL BUCKET

1) GENERAL BUCKET

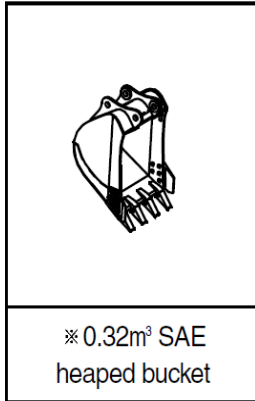

| Capacity | | Width | | Weight | Recommendation |
|--|--|------------------------|---------------------|------------------|----------------------------|
| | | | | | 3.7m (12' 2") Mono boom |
| SAE heaped | CECE heaped | Without side cutter | With side cutter | | 1.67m arm (5' 6") |
| ※ 0.32m ³ (0.42yd ³) | 0.28m ³ (0.37yd ³) | 670mm (26.4") | 750mm (29.5") | 230kg (510lb) | |

※ : Standard bucket

Applicable for materials with density of 2000kg/m³ (3370lb/yd³) or less

7. UNDERCARRIAGE

1) TRACKS

X-leg type center frame is integrally welded with reinforced box-section track frames. The design includes dry tracks, lubricated rollers, idlers, sprockets, hydraulic track adjusters with shock absorbing springs and assembled track-type tractor shoes with triple grousers.

2) TYPES OF SHOES

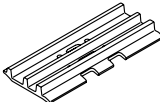
| Model | Shapes | | Triple grouser | |
|-------|------------------|---------------------------|--|-------------|
| | | |  | |
| R80-7 | Shoe width | mm(in) | 450(18) | 600(24) |
| | Operating weight | kg(lb) | 7800(17196) | 7960(17550) |
| | Ground pressure | kgf/cm ² (psi) | 0.37(5.26) | 0.28(3.98) |
| | Overall width | mm(ft-in) | 2260(7' 5") | 2350(7' 9") |

3) NUMBER OF ROLLERS AND SHOES ON EACH SIDE

| Item | Quantity |
|-----------------|----------|
| Carrier rollers | 1EA |
| Track rollers | 5EA |
| Track shoes | 38EA |

4) SELECTION OF TRACK SHOE

Suitable track shoes should be selected according to operating conditions.

※ **Table 1**

| Track shoe | Specification | Category |
|----------------------|---------------|----------|
| 450mm triple grouser | Standard | A |
| 600mm triple grouser | Option | A |

※ **Table 2**

| Category | Applications | Precautions |
|----------|---------------------------------------|---|
| A | Rocky ground, river beds, normal soil | <ul style="list-style-type: none"> Travel at low speed on rough ground with large obstacles such as boulders or fallen trees |

8.SPECIFICATIONS FOR MAJOR COMPONENTS

1) ENGINE

| Item | Specification |
|-------------------------------------|----------------------------------|
| Model | KOEL 4R1040NA |
| Type | 4-cycle diesel engine |
| Cooling method | Water cooling |
| Number of cylinders and arrangement | 4 cylinders, in-line |
| Firing order | 1-3-4-2 |
| Combustion chamber type | Direct injection type |
| Cylinder bore ×stroke | 105 ×120mm(4.13" ×4.72") |
| Piston displacement | 4160cc(254cu in) |
| Compression ratio | 18:1 |
| Rated gross horse power(SAE J1995) | 76Hp at 2200rpm(57kW at 2200rpm) |
| Maximum torque at 1400rpm | 29.6kgf ·m(214lbf ·ft) |
| Engine oil quantity | 11.5 ℓ (3.0U.S. gal) |
| Dry weight | 500kg(584lb) |
| High idling speed | 2400 ±50rpm |
| Low idling speed | 1000 ±50rpm |
| Rated fuel consumption | 167g/Hp ·hr at 2200rpm |
| Starting motor | Lucas 24V-4.5kW |
| Alternator | Lucas 24V, 55A |
| Battery | 2 ×12V ×68AH |

2) MAIN PUMP

| Item | Specification |
|------------------|--|
| Type | Variable displacement tandem axis piston pumps |
| Capacity | 2 ×36cc/rev |
| Maximum pressure | 280kgf/cm ² (3983psi) |
| Rated oil flow | 2 ×75.6 ℓ/min (2 ×20U.S.gpm) |
| Rated speed | 1950rpm |

3) GEAR PUMP

| Item | Specification |
|------------------|---|
| Type | Fixed displacement gear pump single stage |
| Capacity | 8.9cc/rev |
| Maximum pressure | 35kgf/cm ² (500psi) |
| Rated oil flow | 18.2 l /min(4.8U.S.gpm/4.0U.K.gpm) |

4) MAIN CONTROL VALVE

| Item | Specification |
|--------------------------------|----------------------------------|
| Type | 11 spools mono-block |
| Operating method | Hydraulic pilot system |
| Main relief valve pressure | 280kgf/cm ² (3980psi) |
| Overload relief valve pressure | 310kgf/cm ² (4410psi) |

5) SWING MOTOR

| Item | Specification |
|------------------------|--|
| Type | Axial piston motor |
| Capacity | 43cc/rev |
| Relief pressure | 190kgf/cm ² (2702psi) |
| Braking system | Automatic, spring applied hydraulic released |
| Braking torque | 14kgf · m ² (101lb · ft) |
| Brake release pressure | 20~40kgf/cm ² (284~569psi) |
| Reduction gear type | 2 - stage planetary |
| Swing speed | 12.0 rpm |

6) TRAVEL MOTOR

| Item | Specification |
|------------------------|--|
| Type | Variable displacement axial piston motor |
| Relief pressure | 300kgf/cm ² (4270psi) |
| Reduction gear type | 2 stage planetary |
| Braking system | Automatic, spring applied hydraulic released |
| Brake release pressure | Less than 9kgf/cm ² (128psi) |
| Braking torque | 8.4kgf · m ² (61lb · ft) |

7) REMOTE CONTROL VALVE

| Item | | Specification |
|--------------------|---------|--------------------------------|
| Type | | Pressure reducing type |
| Operating pressure | Minimum | 5kgf/cm ² (71psi) |
| | Maximum | 20kgf/cm ² (284psi) |
| Push rod stroke | Lever | 6.5/8.5mm (0.26/0.34in) |

8) CYLINDER

| Item | | Specification |
|-----------------|-----------------------------|----------------------|
| Boom cylinder | Bore dia × Rod dia × Stroke | ∅ 115 × ∅ 70 × 980mm |
| | Cushion | Extend only |
| Arm cylinder | Bore dia × Rod dia × Stroke | ∅ 95 × ∅ 60 × 860mm |
| | Cushion | Extend and retract |
| Bucket cylinder | Bore dia × Rod dia × Stroke | ∅ 85 × ∅ 55 × 665mm |
| | Cushion | Extend only |
| Dozer cylinder | Bore dia × Rod dia × Stroke | ∅ 110 × ∅ 65 × 152mm |
| | Cushion | - |

※ Discoloration of cylinder rod can occur when the friction reduction additive of lubrication oil spreads on the rod surface.

※ Discoloration does not cause any harmful effect on the cylinder performance.

9) SHOE

| Item | | Width | Ground pressure | Link quantity | Overall width |
|------|----------|------------|-----------------------------------|---------------|----------------|
| R80 | Standard | 450mm(18") | 0.37kgf/cm ² (5.26psi) | 38 | 2260mm(7' 5") |
| | Option | 600mm(24") | 0.28kgf/cm ² (3.98psi) | 38 | 2350mm(7' 9") |

10) BUCKET

| Item | | Capacity | | Tooth quantity | Width | |
|------|-----|---|---|----------------|---------------------|------------------|
| | | SAE heaped | CECE heaped | | Without side cutter | With side cutter |
| R80 | STD | 0.32m ³ (0.42yd ³) | 0.25m ³ (0.33yd ³) | 4 | 725mm(28.5") | 740mm(29.1") |

9. RECOMMENDED OILS

**Use only oils listed below or equivalent.
Do not mix different brand oil.**

| Service point | Kind of fluid | Capacity l (U.S. gal) | Ambient temperature C° (F°) | | | | | | |
|------------------------------|--|--------------------------|-------------------------------------|-------------|-----------|------------|------------|------------|-------------|
| | | | -20 (-4) | -10 (14) | 0 (32) | 10 (50) | 20 (68) | 30 (86) | 40 (104) |
| Engine oil pan | Engine oil | 11.5(3.04) | SAE 30 | | | | | | |
| | | | SAE 10W | | | | | | |
| | | | SAE 10W-30 | | | | | | |
| | | | SAE 15W-40 | | | | | | |
| Swing drive | Gear oil | 1.5(0.4) | SAE 85W-140 | | | | | | |
| Final drive | | 1.2×2 (0.32×2) | | | | | | | |
| Swing drive | Grease | 0.2kg(0.4lb) | NLGI NO.1 | | | | | | |
| | | | NLGI NO.2 | | | | | | |
| Hydraulic tank | Hydraulic oil | Tank:75(19.8) | ISO VG 32 | | | | | | |
| | | System: 130(34.3) | ISO VG 46 | | | | | | |
| | | ISO VG 68 | | | | | | | |
| Fuel tank | Diesel fuel | 135(35.7) | ASTM D975 NO.1 | | | | | | |
| | | | ASTM D975 NO.2 | | | | | | |
| Fitting (Grease nipple) | Grease | As required | NLGI NO.1 | | | | | | |
| | | | NLGI NO.2 | | | | | | |
| Radiator (Reservoir tank) | Mixture of antifreeze and water 50 : 50 | 20(5.3) | Ethylene glycol base permanent type | | | | | | |

SAE : Society of Automotive Engineers
API : American Petroleum Institute
ISO : International Organization for Standardization
NLGI : National Lubricating Grease Institute
ASTM : American Society of Testing and Material