

GROUP 3 PUMP DEVICE

1. REMOVAL AND INSTALL

1) REMOVAL

- (1) Lower the work equipment to the ground and stop the engine.
- (2) Operate the control levers and pedals several times to release the remaining pressure in the hydraulic piping
- (3) Loosen the breather slowly to release the pressure inside the hydraulic tank.

▲ Escaping fluid under pressure can penetrate the skin causing serious injury.

- (4) Loosen the drain plug under the hydraulic tank and drain the oil from the hydraulic tank.
 - Hydraulic tank quantity : 75 l
- (5) Disconnect hoses(4) and remove connectors(3).
- (6) Disconnect pilot line hoses(6,8) and remove connectors(5,7).
- (7) Remove socket bolts(2) and disconnect pump suction tube(1).
 - ※ When pump suction tube is disconnected, the oil inside the piping will flow out, so catch it in oil pan.
- (8) Sling the pump assembly and remove the pump mounting bolts.
 - Weight : 50kg(110lb)
 - ※ Pull out the pump assembly from housing. When removing the pump assembly, check that all the hoses have been disconnected.

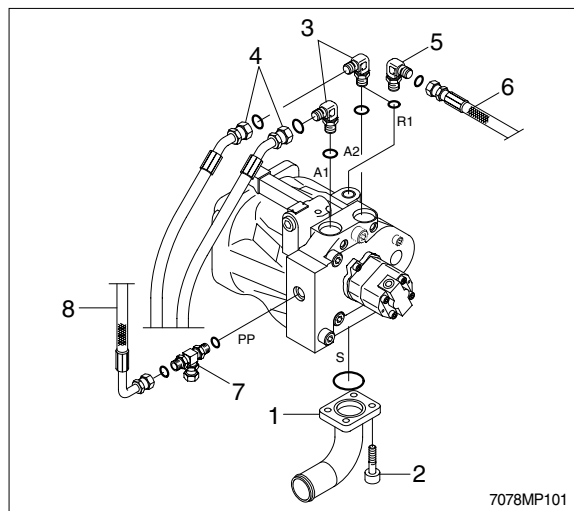

2) INSTALL

- (1) Carry out installation in the reverse order to removal.
- (2) Remove the suction strainer and clean it.
- (3) Replace return filter with new one.
- (4) Remove breather and clean it.
- (5) After adding oil to the hydraulic tank to the specified level.
- (6) Bleed the air from the hydraulic pump.
 - ① Remove the air vent plug(1EA).
 - ② Tighten plug lightly.
 - ③ Start the engine, run at low idling, and check oil come out from plug.
 - ④ Tighten plug.
- (7) Start the engine, run at low idling(3~5 minutes) to circulate the oil through the system.
- (8) Confirm the hydraulic oil level and check the hydraulic oil leak or not.

2. MAIN PUMP(1/2)

1) STRUCTURE

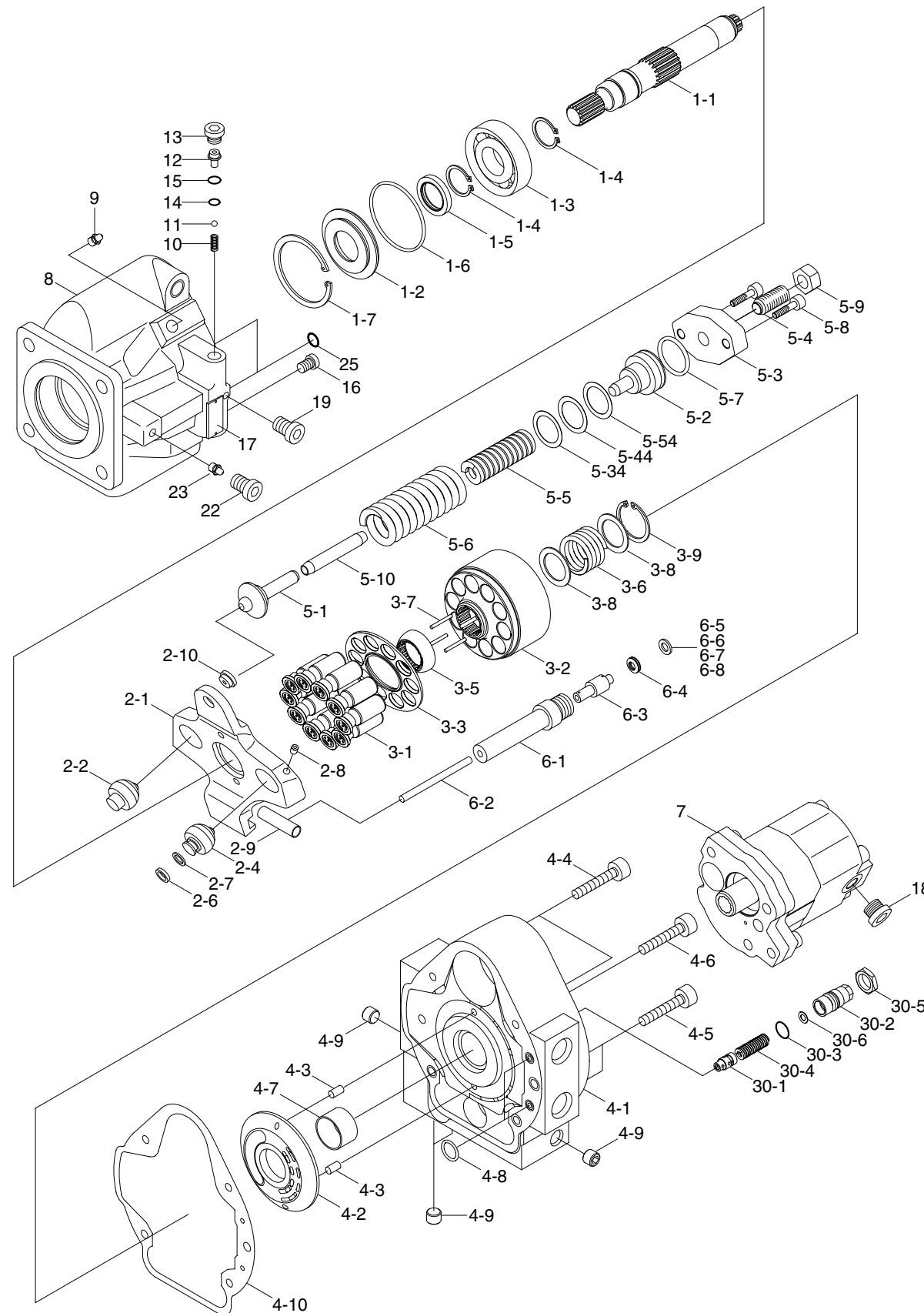

- | | | | |
|------|-------------------------|------|-------------------------|
| 1 | Shaft assembly | 5-5 | Spring |
| 1-1 | Shaft | 5-6 | Spring |
| 1-2 | Seal retainer | 5-7 | O-ring |
| 1-3 | Bearing | 5-8 | Bolt |
| 1-4 | Retaining ring | 5-9 | Nut |
| 1-5 | Oil seal | 5-10 | Guide |
| 1-6 | O-ring | 5-34 | Shim |
| 1-7 | Retaining ring | 5-44 | Shim |
| 2 | Swash plate assembly | 5-54 | Shim |
| 2-1 | Hanger | 6 | Control spring assembly |
| 2-2 | Guide | 6-1 | Cylinder |
| 2-4 | Guide | 6-2 | Piston |
| 2-6 | O-ring | 6-3 | Piston |
| 2-7 | Back up ring | 6-4 | Plate spring |
| 2-8 | Plug | 6-5 | Spacer |
| 2-9 | Pin | 6-6 | Spacer |
| 2-10 | Bush | 6-7 | Spacer |
| 3 | Rotary group | 6-8 | Spacer |
| 3-1 | Piston | 7 | Gear pump |
| 3-2 | Cylinder block | 8 | Housing |
| 3-3 | Retainer | 9 | Air vent valve |
| 3-5 | Guide | 10 | Bush |
| 3-6 | Spring | 11 | Steel ball |
| 3-7 | Parallel pin | 12 | Plug |
| 3-8 | Spring spacer | 13 | Plug |
| 3-9 | Retaining ring | 14 | Packing |
| 4 | Port plate assembly | 15 | Shim |
| 4-1 | Cover | 16 | Plug |
| 4-2 | Control plate | 17 | Name plate assembly |
| 4-3 | Parallel pin | 18 | Plug |
| 4-4 | Bolt | 19 | Plug |
| 4-5 | Bolt | 22 | Plug assembly |
| 4-6 | Bolt | 23 | Orifice |
| 4-7 | Bearing | 25 | Square ring |
| 4-8 | Square ring | 30 | Relief valve |
| 4-9 | Plug | 30-1 | Spool |
| 4-10 | Packing | 30-2 | Adjust screw |
| 5 | Control spring assembly | 30-3 | O-ring |
| 5-1 | Spring spacer | 30-4 | Spring |
| 5-2 | Spring spacer | 30-5 | Nut |
| 5-3 | Cover | 30-6 | Shim |
| 5-4 | Adjust screw | | |

7078MP102

2) NECESSARY TOOLS AND JIGS

The following tools and jigs are necessary to disassemble and assemble the pump.

(1) Tools

Name	Size(nominal)
Hexagon socket screw keys	6, 8, 10, 12mm
Spanner	14, 17, 24, 27
Screwdrivers for slotted-head screws	Middle
Pliers for retaining rings	Bore use 80
Grease	-
Adhesive	Three Bond #1305
Plastic hammer	Medium size

(2) Jigs

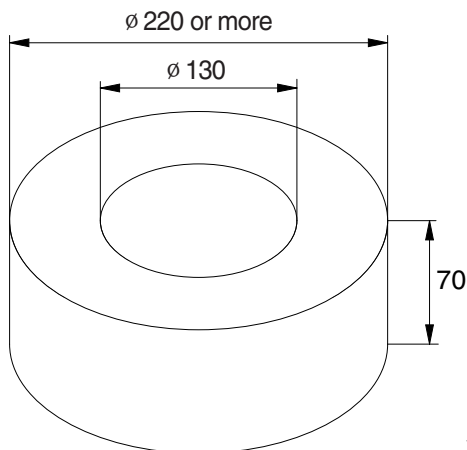

7078MP50

This is a table to stand the pump facing downward

3) CAUTIONS DURING DISASSEMBLING AND ASSEMBLING

(1) Cautions for disassembling

- ① Never attempt operating the adjusting screws unless absolutely necessary.
- ② Take utmost care during disassembly not to knock or drop each part.

(2) Cautions for assembling

- ① Wash each part thoroughly.
- ② During assembling take utmost care not to damage the part or allow foreign materials to enter.
- ③ As a rule the O-ring and oil seal should not be reused.
- ④ In our assembly work the torque wrench is used to control the torque.
Be sure to use the torque wrench.

3. DISASSEMBLING

1) DISASSEMBLING THE GEAR PUMP

- (1) Remove the hexagon socket head cap screws. (M10×25, 2pcs)
L-wrench(8)
- (2) Remove the coupling and bush.

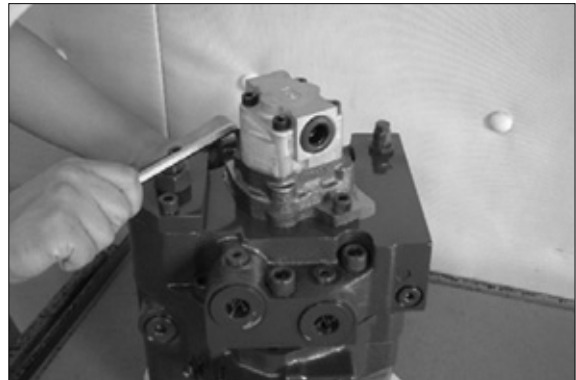

7078MP01

2) DISASSEMBLING THE MAIN PUMP

(1) Removing of the cover

- ① Remove the hexagon socket head cap screws.
(M14×40, 2 pieces)
(M14×65, 2 pieces)
(M14×75, 1 pieces)
L-wrench(12)

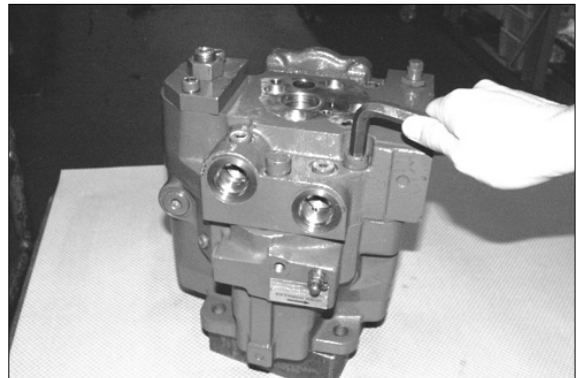

7078MP02

- ② Removing the cover.
 - ※ Be careful because the control plate is provided to the backside.
 - ※ When the cover is difficult to remove, knock lightly with a plastic hammer.

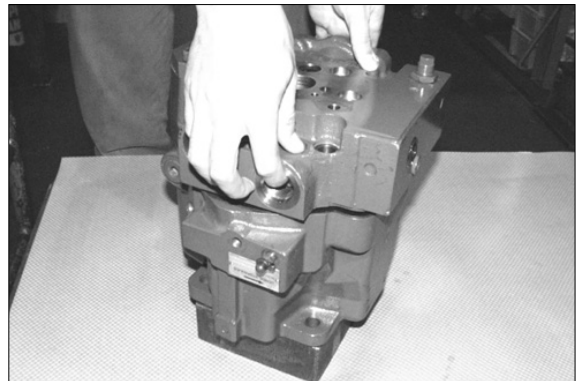

7078MP03

- ③ Removing of the spring and the guide and the spring seat.

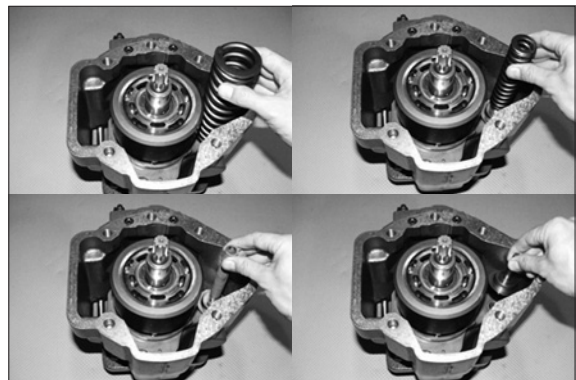

7078MP04-04C

(2) Removing of the rotary group

- ① Lay the pump on the side and take out the rotary group from the shaft.

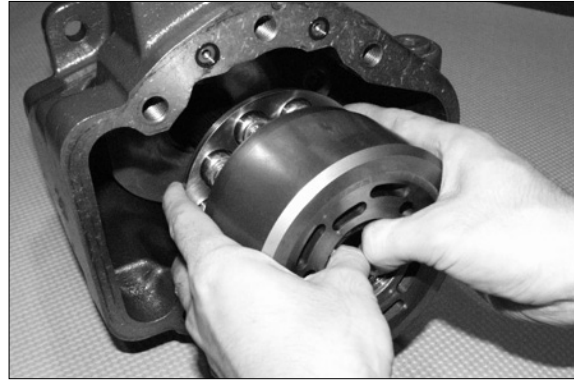

7078MP05

- ② 3 Parallel pins may remain in the housing when removing rotary group. Please take out 3 parallel pins when they were left in the housing.



7078MP06

(3) Removing of the shaft

- ① Removing the retaining ring.
(Pliers for retaining rings, Bore use 80)

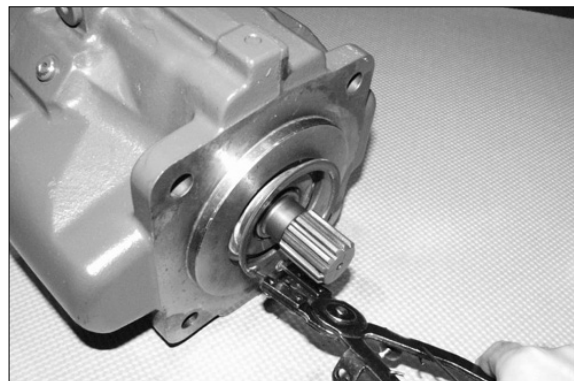

7078MP07

- ② Removing the oil seal case.
(Two screwdrivers)
- ③ Remove the O-ring.



7078MP08

④ Remove the shaft

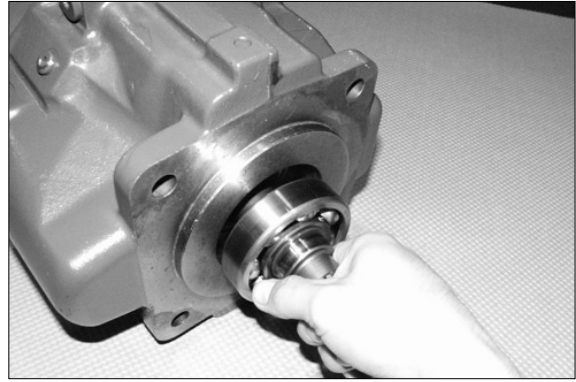

7078MP09

⑤ Removing the swash plate.



7078MP10

⑥ Removing the guides.

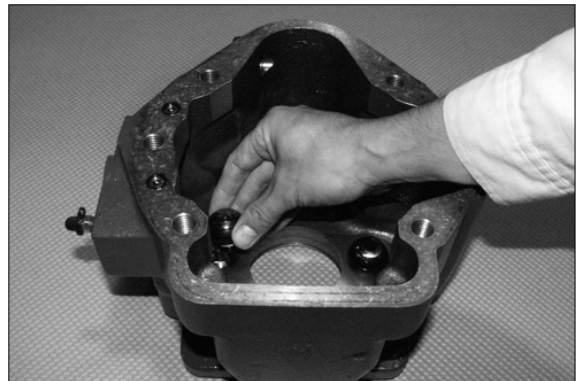

7078MP11

(4) Disassembling of the cover

- ① Removing the control plate.

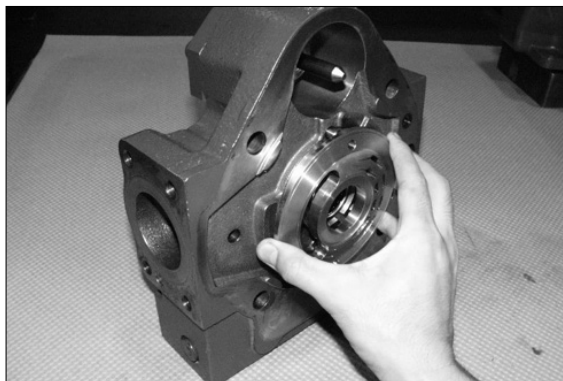

7078MP12

- ② Remove the piston and cylinder.
Spanner (27)

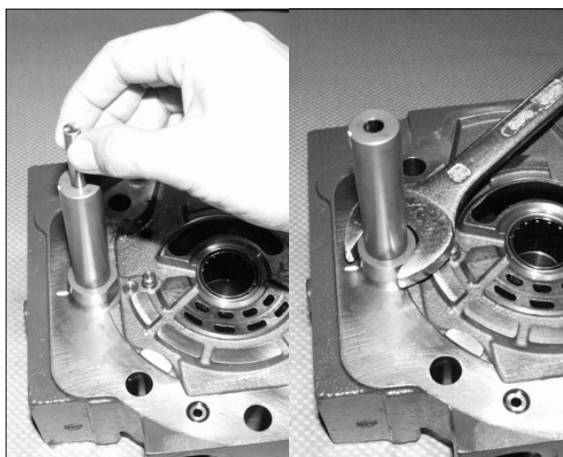

7078MP13/13A

- ③ Remove the piston.
- ④ Remove the coned disk springs and distance piece.

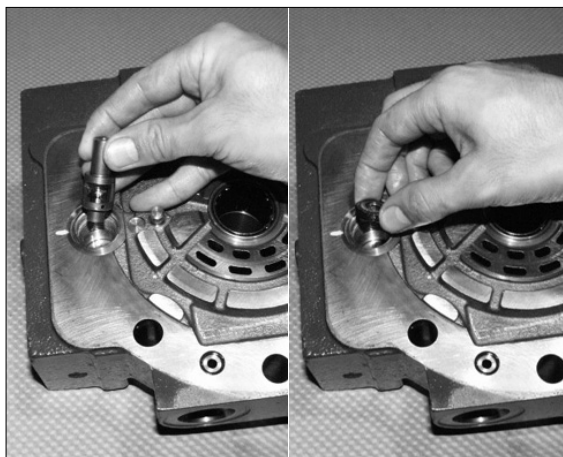

7078MP14/14A

(5) Removing the cover

- ① Remove the hexagon socket head cap screws. (M10×30, 2 pieces)
L-wrench(8)

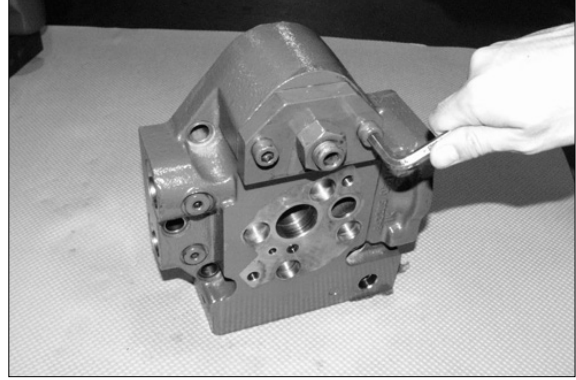

7078MP15

- ② Remove the spring seat.

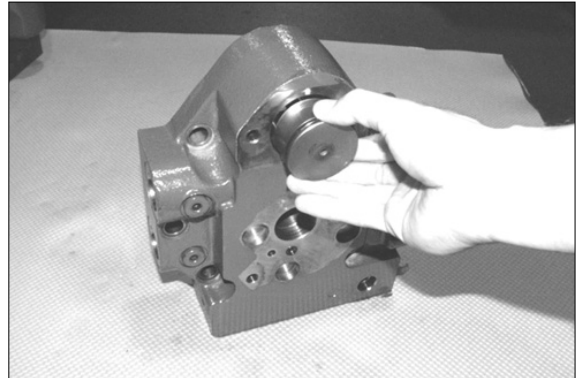

7078MP16

- ③ Removing the relief valve.
Removing the hexagon nut.
Since the pressure has been set, this assembly must be made only when necessary.
Spanner (24)

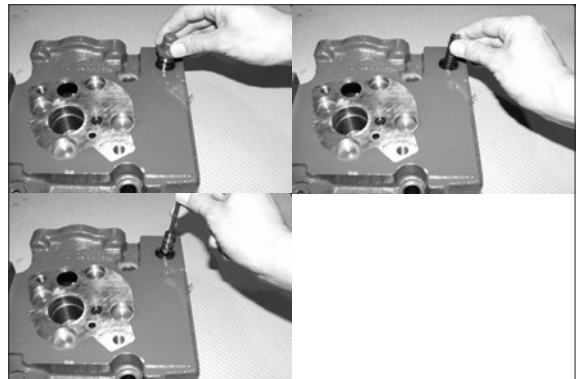

7078MP17-17B

- ④ Remove the adjusting screw.
Be careful because the shim is inserted.
Spanner (14)

- ⑤ Remove the spring and spool.

4. ASSEMBLING

(1) Assembling of the cover

- ① Assembling the relief valve.
- ② Install the spool and spring.
- ③ Install the shim into the adjusting screw.

Tighten the hexagonal nut.

After assembling, set the pressure and tighten the nuts.

Tightening torque $9.8\text{N} \cdot \text{m}$ ($7.2\text{lbf} \cdot \text{ft}$)

Spanner(24)

Spanner(14)

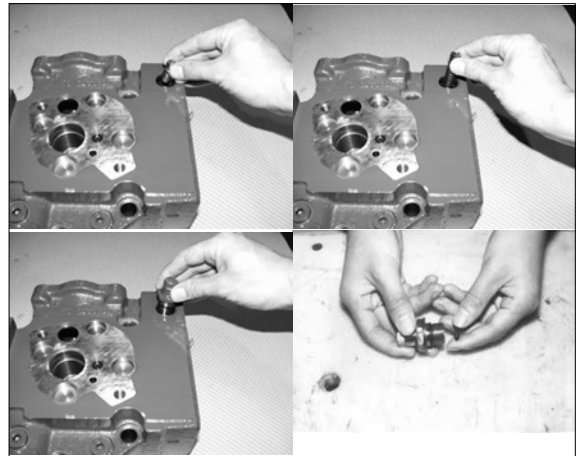

7078MP18-18C

- ④ Install the spring seat into the cover.

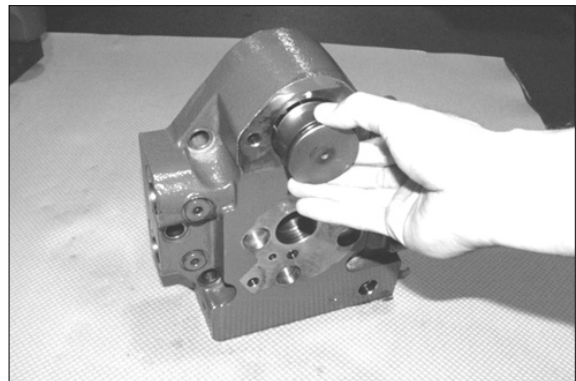

7078MP19

(2) Assemble the cover

- ① Fix the hexagon socket head cap screws.
(M10 × 30, 2 pieces)

L-wrench(8)

- Tightening torque $55\sim 69\text{N} \cdot \text{m}$
($41\sim 51\text{lbf} \cdot \text{ft}$)

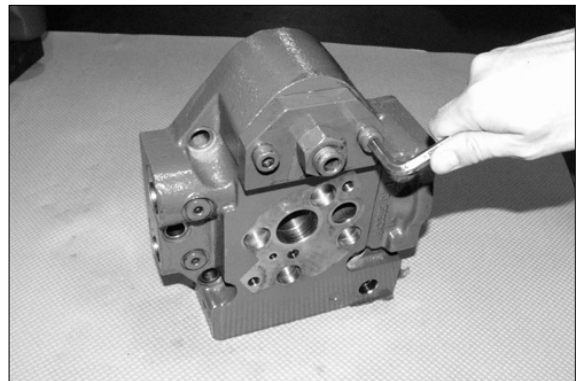

7078MP20

② Assemble the control piston.

※ Apply three bond #1305 to the thread of the cylinder.

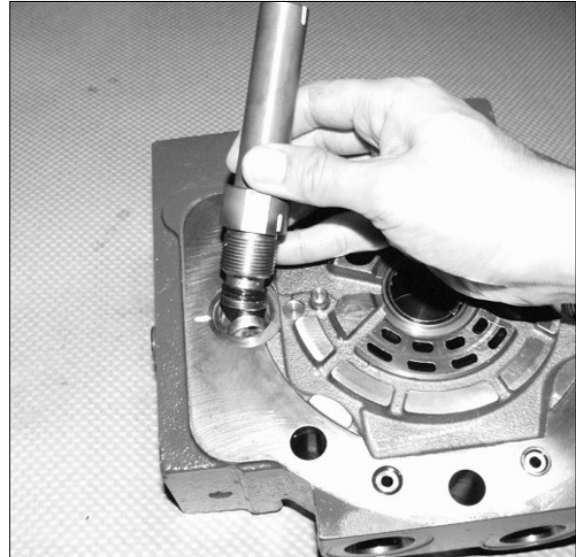
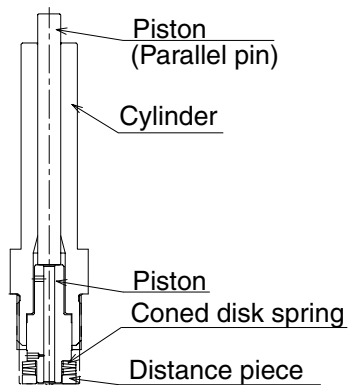

7078MP21A/21

③ Assemble the control piston.

Spanner (27)

· Tightening torque 126~157N · m
(93~116lb · ft)

④ Install the piston.

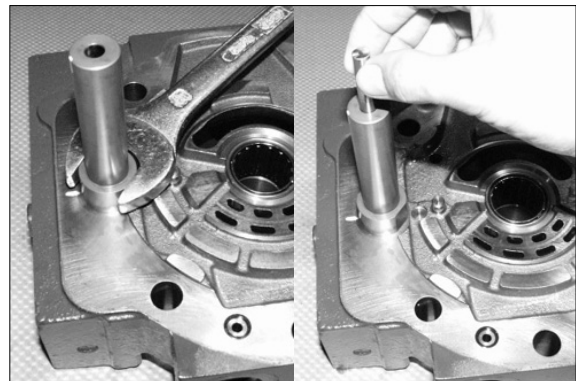

7078MP22/22A

⑤ Apply grease to the back side of the control plate.

(To prevent dislodgement)

And assemble it to the cover while matching knock holes.

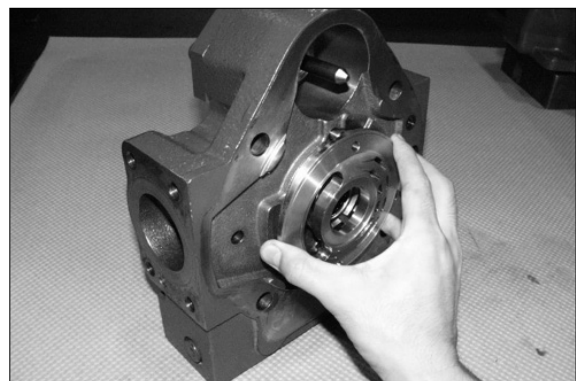

7078MP23

(3) Assembling of the swash plate

- ① Install the guides into the housing.

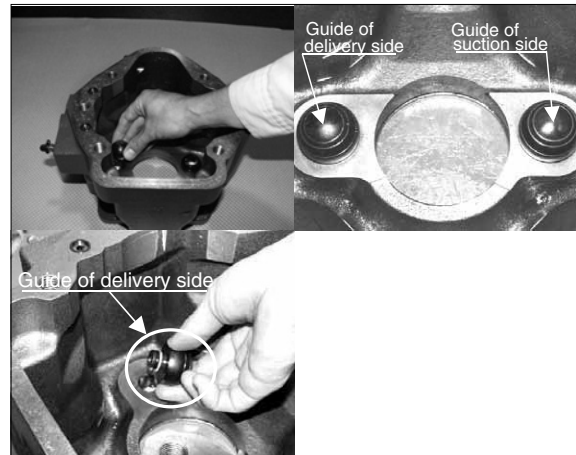

7078MP24-24B

- ② Install the swash plate into the housing.

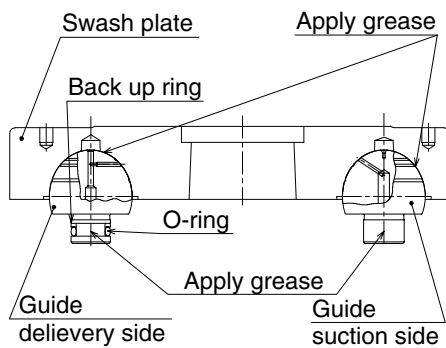

7078MP25A/25

(4) Assembling of the shaft

- ① Install the shaft into the housing.
Fix the bearing outer ring firmly into the housing hole.

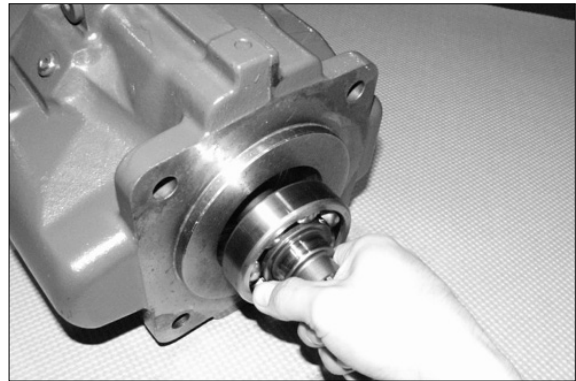

7078MP26

- ② Apply grease to the O-ring for assembling.



7078MP27

- ③ Install the oil seal case into the shaft.
Apply grease to the oil seal lip beforehand.

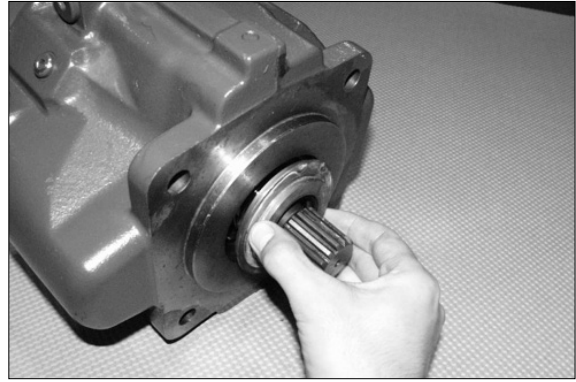

7078MP28

- ④ Install the retaining ring to fix the shaft.
(Pliers for retaining rings, bore use 80)



7078MP29

(5) Assembling of the rotary group

- ① Apply grease to 3 parallel pins.
Install 3 parallel pins into the cylinder block.



7078MP30

- ② Apply grease to the guide.
Install the guide on 3 parallel pins

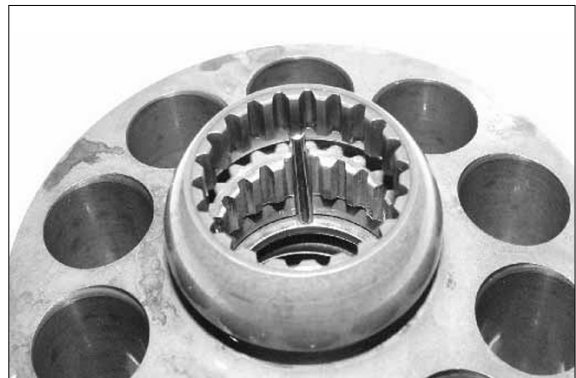

7078MP30A

- ③ Install the piston(10 pistons) into the retainer.
- ④ Apply grease to the piston.
Install the piston and the retainer into the hole of cylinder block.



7078MP31

- ⑤ Install the rotary group into the housing.
(Along the shaft spline)
- ⑥ Apply grease to slide surface of the piston shoe and to the slide surface of the cylinder block relative to the control plate.

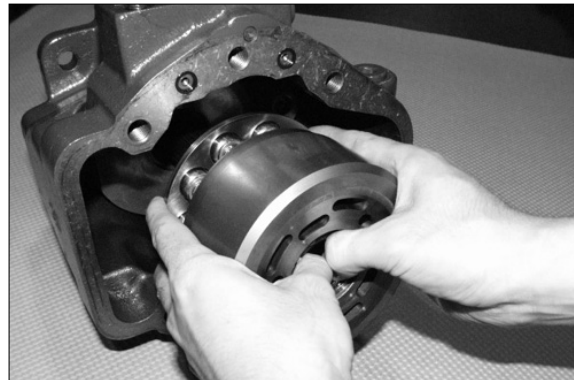

7078MP32

(5) Assembling of the spring seat

- ① Apply grease to the spherical portion of the spring seat.
Install the spring seat into the bush.
- ② Install the spring guide and springs into the housing.

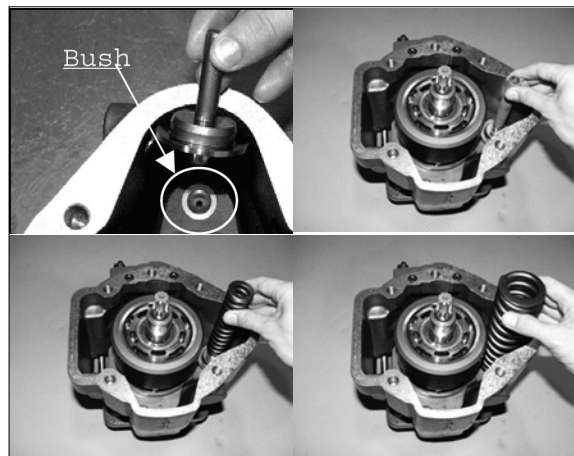

7078MP33-33C

- ③ Install the packing.

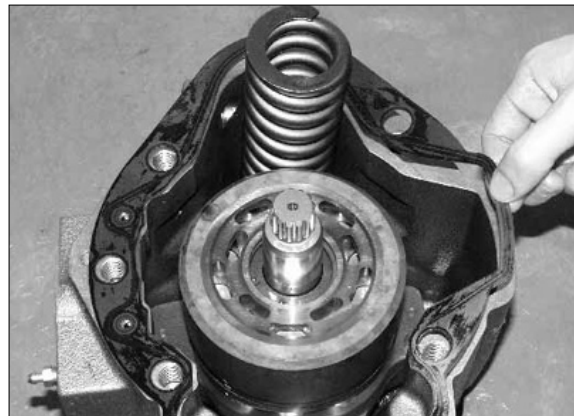

7078MP34

- ④ Join together housing and cover.
Fix the hexagon socket head cap screws.
(M14×40, 2 pieces)
(M14×65, 2 pieces)
(M14×75, 1 pieces)
- L-wrench(12)
· Tightening torque 150~180N·m
(111~133lb·ft)

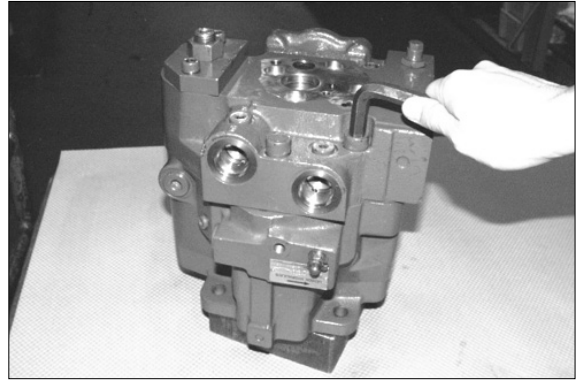

7078MP34

5. DISASSEMBLING

(1) Disassembling the gear pump

- ① Remove the hexagon socket head cap screws. (M8 × 50, 4pcs)



7078MP38

- ② Remove the side plate, backup ring, square ring and gears while pulling out the drive gear and idle gear.

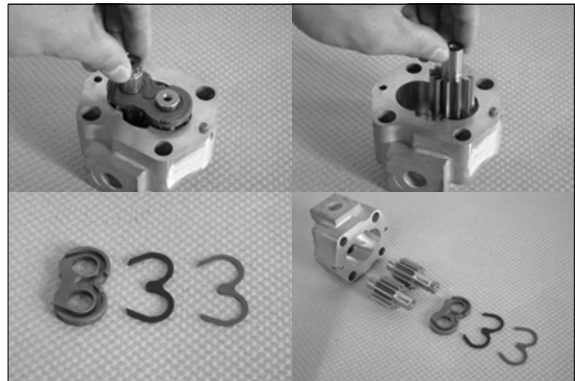

7078MP39-39C

- ③ Removing the front frame.

Remove the hexagon head bolts,
(M10 × 2, 4pcs)

Spanner (17)



7078MP40

6. ASSEMBLING

(1) Assembling the gear pump

- ① Assemble the idle and drive gear into the housing.
- ② Assemble the side plate assy.
Apply grease to the square ring and backup ring to prevent dislodgement and assemble them in this order.
- ③ Assembled in side plate assy.
Above into the housing.

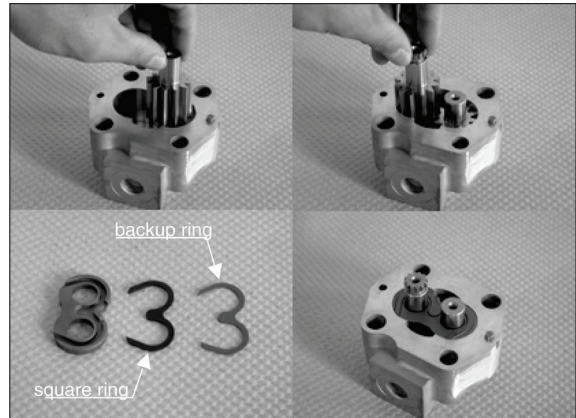

- ④ Assemble the front frame.
- ⑤ Install the O-rings into the front frame.
- ⑥ Install the two parallel pins into the front frame.
- ⑦ Join together intermediate frame.
Fix the hexagon head bolts,
(M10 × 25, 4pcs)
Spanner (17)
· Tightening torque 59N · m (44lbf · ft)

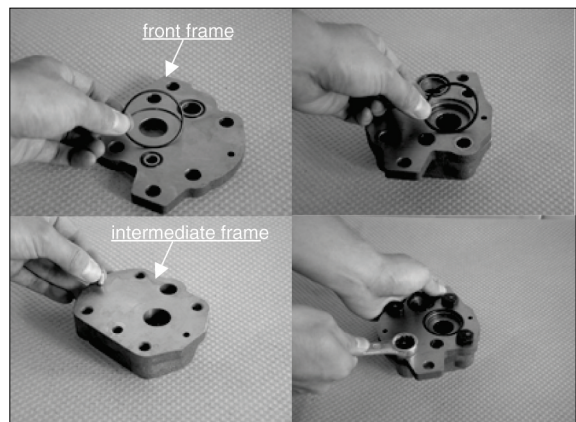

- ⑧ Assemble the intermediate frame.
- ⑨ Install two parallel pins and O-ring.
Fix the hexagon socket head cap screws.
(M8 × 50, 4pcs)
L-wrench(6)
· Tightening torque 29.4N · m (21.4lbf · ft)

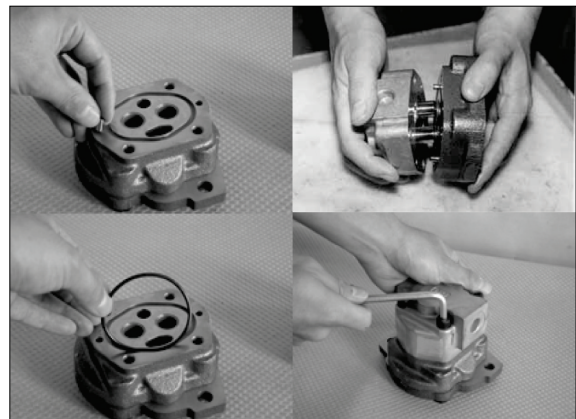

(2) Assembling the gear pump

- ① Install the coupling to the shaft end of the main pump.

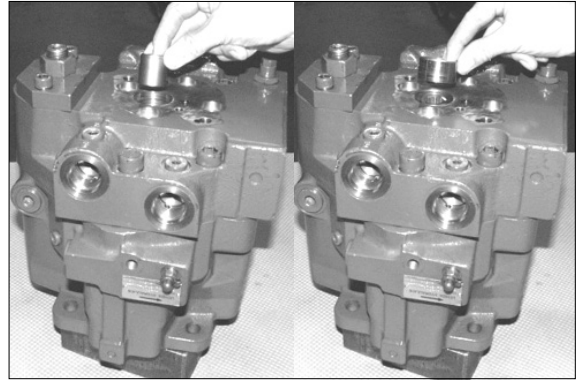

7078MP36/36A

- ② Fix the gear pump with the hexagon socket head cap screws.
(M10 × 25, 2 pieces)

L-wrench(8)

- Tightening torque 55~69N · m
(40~50lbf · ft)

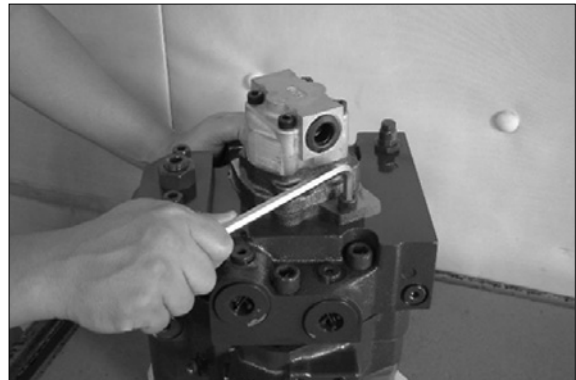

7078MP37