

GROUP 3 TRAVEL SPEED CONTROL SYSTEM

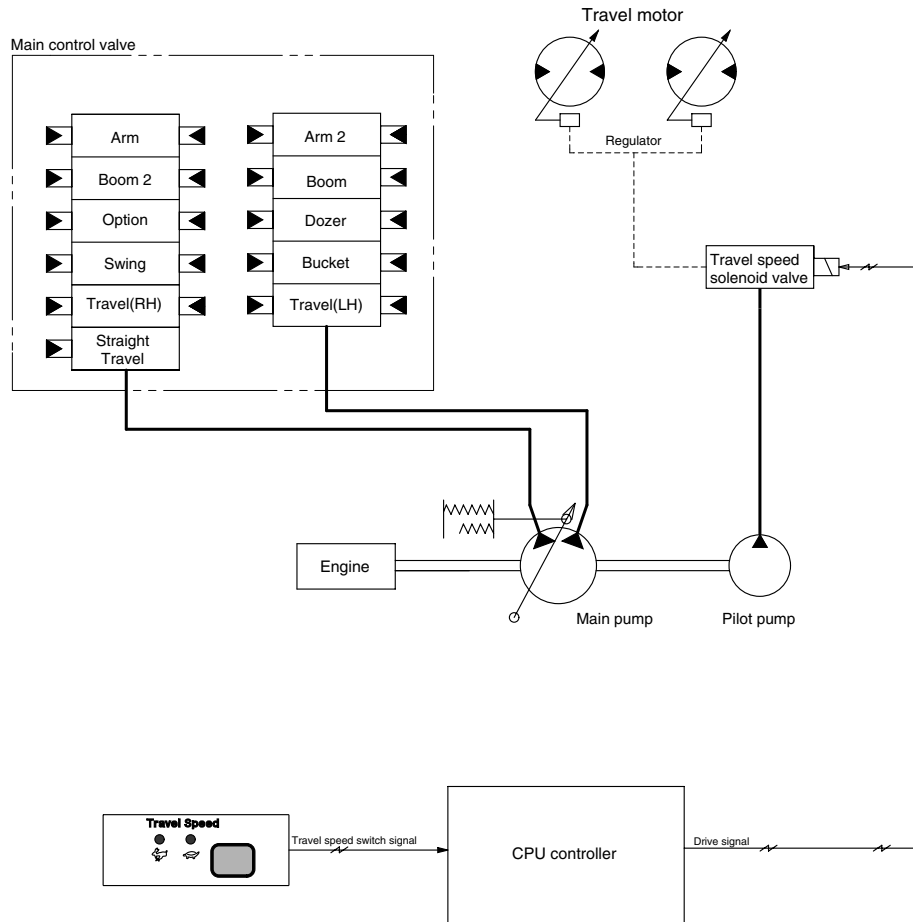

7075MS04

Travel speed can be switched manually by pressing the travel speed switch on the cluster.

Speed	Travel speed solenoid valve	Lamp on cluster	Operation
Lo	OFF	Turtle	Low speed, high driving torque in the travel motor
Hi	ON	Rabbit	High speed, low driving torque in the travel motor

※ Default : Turtle(Lo)