

SECTION 1 GENERAL



Group 1 Safety Hints	1-1
Group 2 Specifications	1-9

SECTION 1 GENERAL

GROUP 1 SAFETY

FOLLOW SAFE PROCEDURE

Unsafe work practices are dangerous. Understand service procedure before doing work; Do not attempt shortcuts.

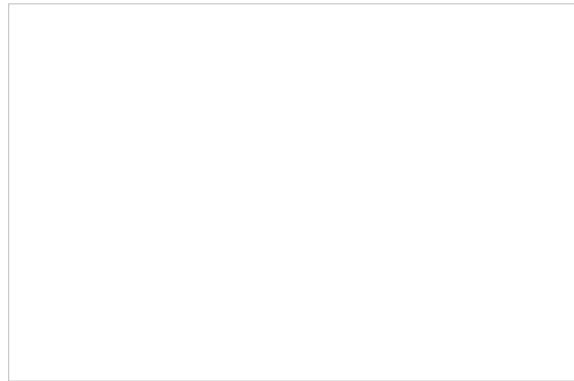

WEAR PROTECTIVE CLOTHING

Wear close fitting clothing and safety equipment appropriate to the job.

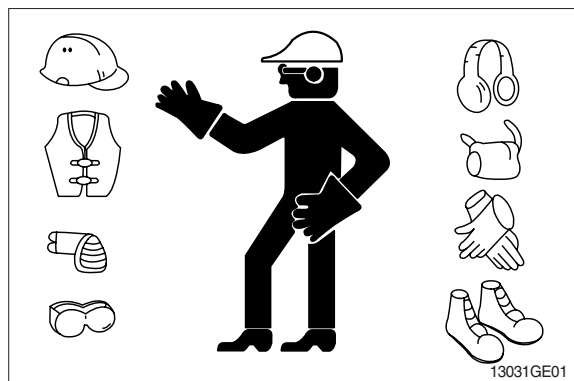

WARN OTHERS OF SERVICE WORK

Unexpected machine movement can cause serious injury.

Before performing any work on the excavator, attach a 「Do Not Operate」 tag on the right side control lever.

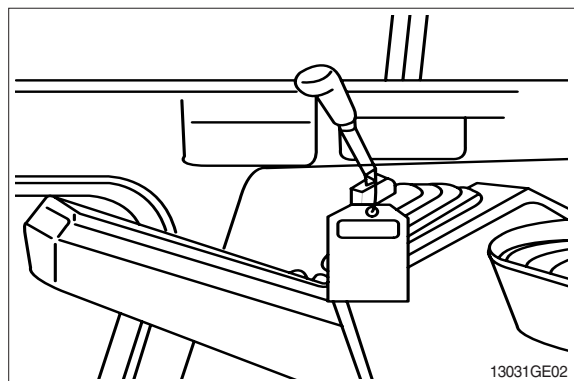

USE HANDHOLDS AND STEPS

Falling is one of the major causes of personal injury.

When you get on and off the machine, always maintain a three point contact with the steps and handrails and face the machine. Do not use any controls as handholds.

Never jump on or off the machine. Never mount or dismount a moving machine.

Be careful of slippery conditions on platforms, steps, and handrails when leaving the machine.

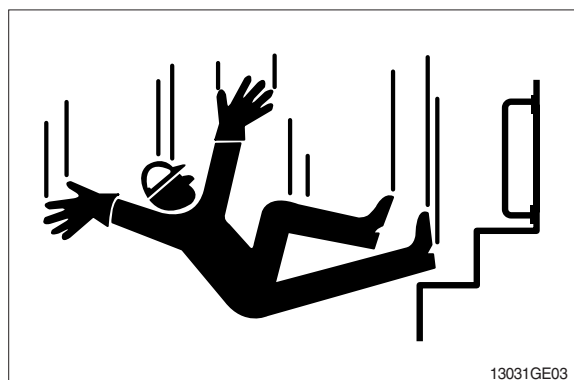

PREPARE FOR EMERGENCIES

Be prepared if a fire starts.

Keep a first aid kit and fire extinguisher handy.

Keep emergency numbers for doctors, ambulance service, hospital, and fire department near your telephone.

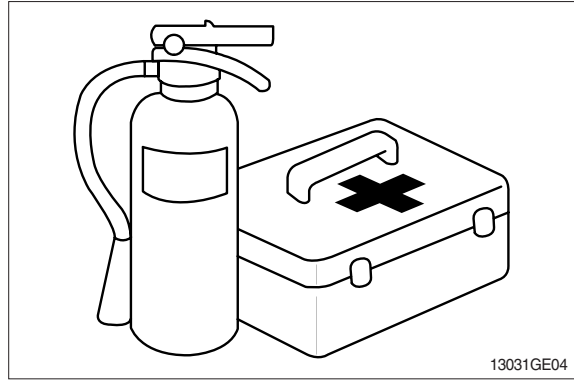

PROTECT AGAINST FLYING DEBRIS

Guard against injury from flying pieces of metal or debris; Wear goggles or safety glasses.

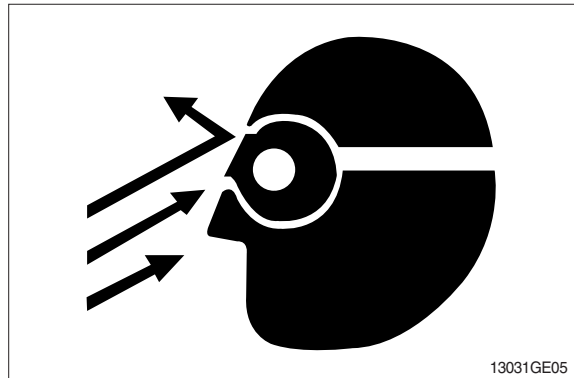

PROTECT AGAINST NOISE

Prolonged exposure to loud noise can cause impairment or loss of hearing.

Wear a suitable hearing protective device such as earmuffs or earplugs to protect against objectionable or uncomfortable loud noises.

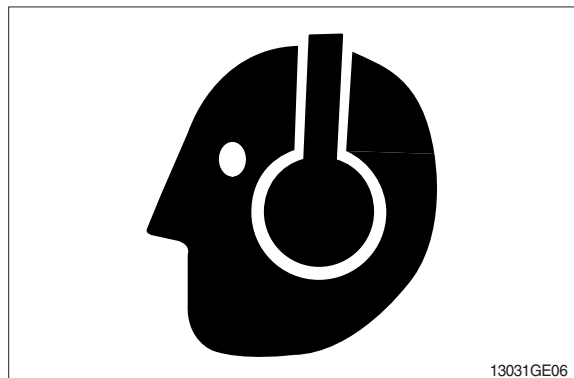

AVOID POWER LINES

Serious injury or death can result from contact with electric lines.

Never move any part of the machine or load closer to electric line than 3m(10ft) plus twice the line insulator length.

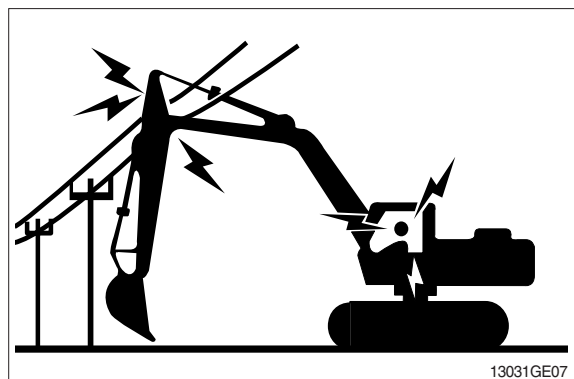

KEEP RIDERS OFF EXCAVATOR

Only allow the operator on the excavator. Keep riders off.

Riders on excavator are subject to injury such as being struck by foreign objects and being thrown off the excavator. Riders also obstruct the operator's view resulting in the excavator being operated in an unsafe manner.

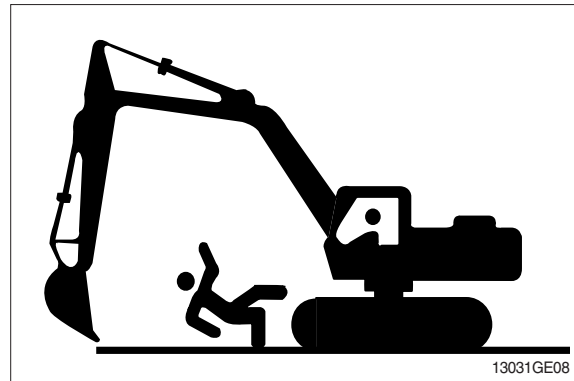

MOVE AND OPERATE MACHINE SAFELY

Bystanders can be run over. Know the location of bystanders before moving, swinging, or operating the machine.

Always keep the travel alarm in working condition. It warns people when the excavator starts to move.

Use a signal person when moving, swinging, or operating the machine in congested areas. Coordinate hand signals before starting the excavator.

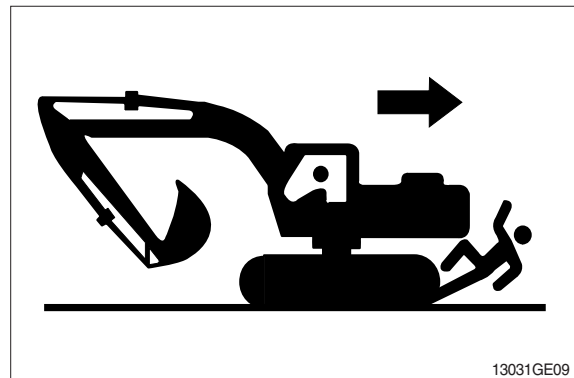

OPERATE ONLY FROM OPERATOR'S SEAT

Avoid possible injury machine damage. Do not start engine by shorting across starter terminals.

NEVER start engine while standing on ground. Start engine only from operator's seat.



PARK MACHINE SAFELY

Before working on the machine:

- Park machine on a level surface.
- Lower bucket to the ground.
- Turn auto idle switch off.
- Run engine at 1/2 speed without load for 2 minutes.
- Turn key switch to OFF to stop engine.
Remove key from switch.
- Move pilot control shutoff lever to locked position.
- Allow engine to cool.

SUPPORT MACHINE PROPERLY

Always lower the attachment or implement to the ground before you work on the machine. If you must work on a lifted machine or attachment, securely support the machine or attachment.

Do not support the machine on cinder blocks, hollow tiles, or props that may crumble under continuous load.

Do not work under a machine that is supported solely by a jack. Follow recommended procedures in this manual.

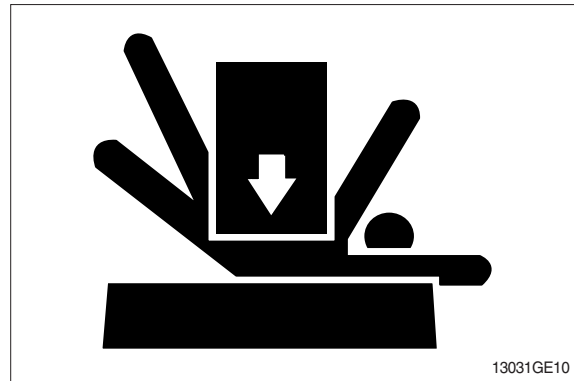

SERVICE COOLING SYSTEM SAFELY

Explosive release of fluids from pressurized cooling system can cause serious burns.

Shut off engine. Only remove filler cap when cool enough to touch with bare hands.

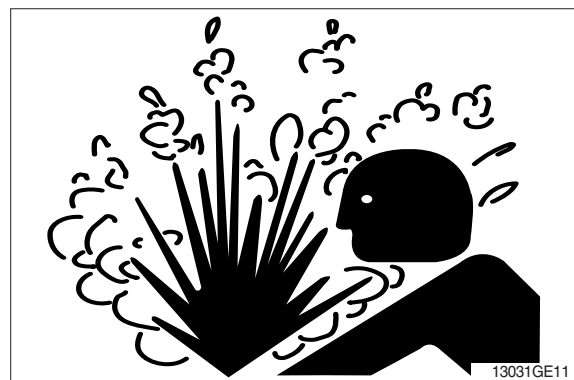

HANDLE FLUIDS SAFELY-AVOID FIRES

Handle fuel with care; It is highly flammable. Do not refuel the machine while smoking or when near open flame or sparks. Always stop engine before refueling machine.

Fill fuel tank outdoors.

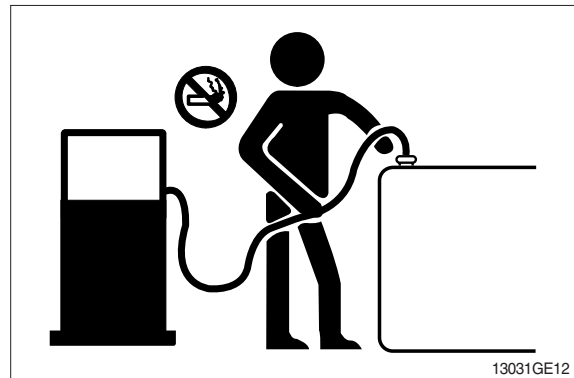

Store flammable fluids away from fire hazards. Do not incinerate or puncture pressurized containers.

Make sure machine is clean of trash, grease, and debris.

Do not store oily rags; They can ignite and burn spontaneously.



BEWARE OF EXHAUST FUMES

Prevent asphyxiation. Engine exhaust fumes can cause sickness or death.

If you must operate in a building, be positive there is adequate ventilation. Either use an exhaust pipe extension to remove the exhaust fumes or open doors and windows to bring enough outside air into the area.

REMOVE PAINT BEFORE WELDING OR HEATING

Avoid potentially toxic fumes and dust.

Hazardous fumes can be generated when paint is heated by welding, soldering, or using a torch.

Do all work outside or in a well ventilated area. Dispose of paint and solvent properly.

Remove paint before welding or heating:

- If you sand or grind paint, avoid breathing the dust. Wear an approved respirator.
- If you use solvent or paint stripper, remove stripper with soap and water before welding. Remove solvent or paint stripper containers and other flammable material from area. Allow fumes to disperse at least 15 minutes before welding or heating.

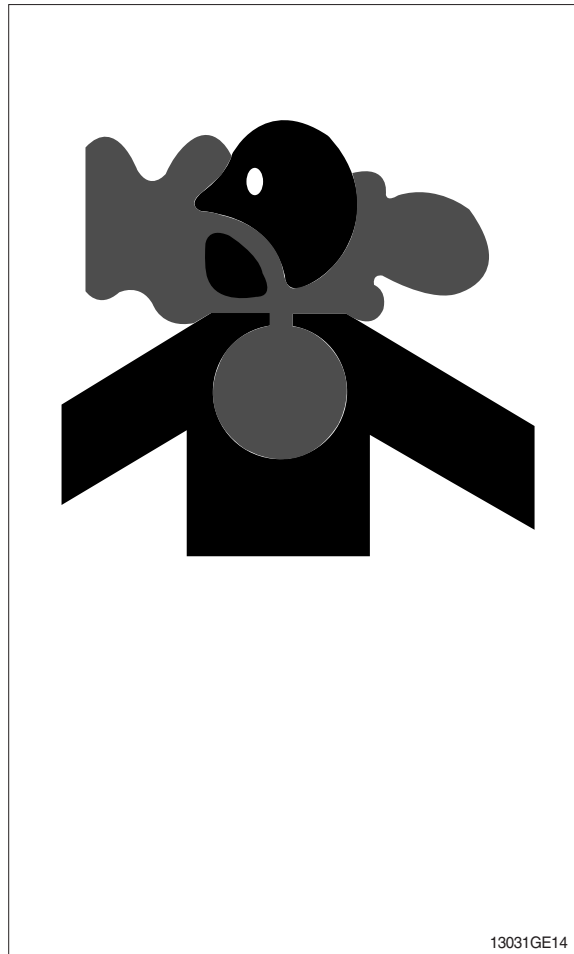

ILLUMINATE WORK AREA SAFELY

Illuminate your work area adequately but safely. Use a portable safety light for working inside or under the machine. Make sure the bulb is enclosed by a wire cage. The hot filament of an accidentally broken bulb can ignite spilled fuel or oil.



SERVICE MACHINE SAFELY

Tie long hair behind your head. Do not wear a necktie, scarf, loose clothing or necklace when you work near machine tools or moving parts. If these items were to get caught, severe injury could result.

Remove rings and other jewelry to prevent electrical shorts and entanglement in moving parts.

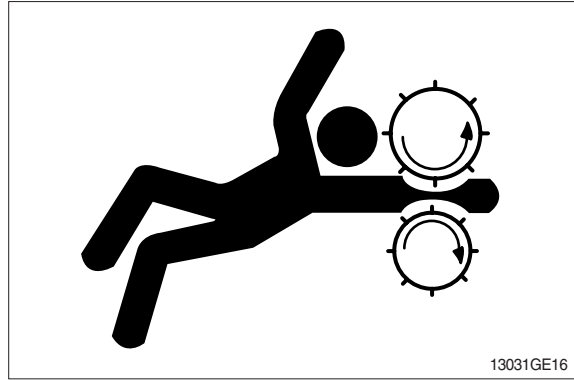

STAY CLEAR OF MOVING PARTS

Entanglements in moving parts can cause serious injury.

To prevent accidents, use care when working around rotating parts.

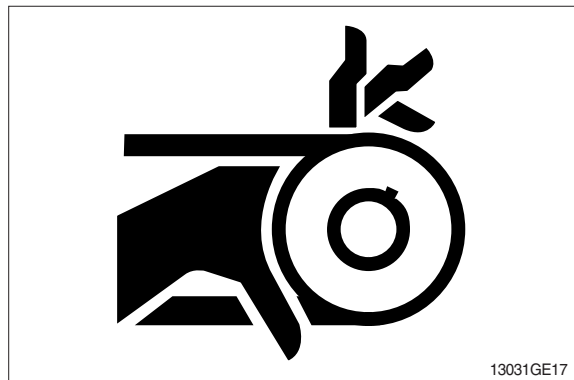

AVOID HIGH PRESSURE FLUIDS

Escaping fluid under pressure can penetrate the skin causing serious injury.

Avoid the hazard by relieving pressure before disconnecting hydraulic or other lines. Tighten all connections before applying pressure.

Search for leaks with a piece of cardboard. Protect hands and body from high pressure fluids.

If an accident occurs, see a doctor immediately. Any fluid injected into the skin must be surgically removed within a few hours or gangrene may result.

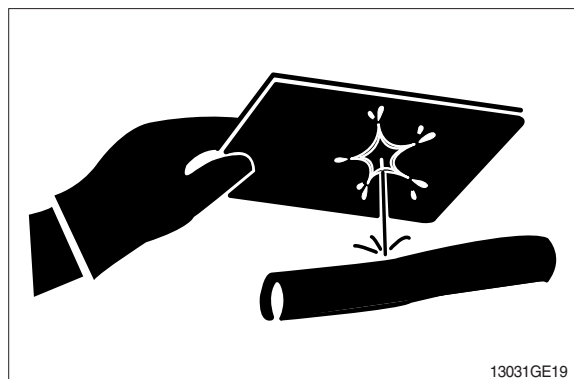

AVOID HEATING NEAR PRESSURIZED FLUID LINES

Flammable spray can be generated by heating near pressurized fluid lines, resulting in severe burns to yourself and bystanders. Do not heat by welding, soldering, or using a torch near pressurized fluid lines or other flammable materials.

Pressurized lines can be accidentally cut when heat goes beyond the immediate flame area. Install fire resisting guards to protect hoses or other materials.



PREVENT BATTERY EXPLOSIONS

Keep sparks, lighted matches, and flame away from the top of battery. Battery gas can explode.

Never check battery charge by placing a metal object across the posts. Use a volt-meter or hydrometer.

Do not charge a frozen battery; It may explode. Warm battery to 16°C (60°F).



PREVENT ACID BURNS

Sulfuric acid in battery electrolyte is poisonous. It is strong enough to burn skin, eat holes in clothing, and cause blindness if splashed into eyes.

Avoid the hazard by:

1. Filling batteries in a well-ventilated area.
2. Wearing eye protection and rubber gloves.
3. Avoiding breathing fumes when electrolyte is added.
4. Avoiding spilling or dripping electrolyte.
5. Use proper jump start procedure.

If you spill acid on yourself:

1. Flush your skin with water.
2. Apply baking soda or lime to help neutralize the acid.
3. Flush your eyes with water for 10-15 minutes. Get medical attention immediately.

If acid is swallowed:

1. Drink large amounts of water or milk.
2. Then drink milk of magnesia, beaten eggs, or vegetable oil.
3. Get medical attention immediately.

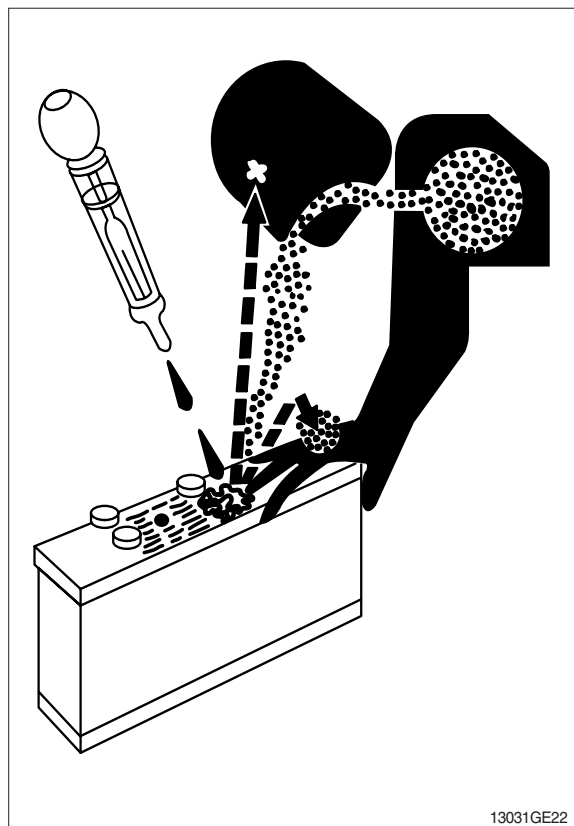

USE TOOLS PROPERLY

Use tools appropriate to the work. Makeshift tools, parts, and procedures can create safety hazards.

Use power tools only to loosen threaded tools and fasteners.

For loosening and tightening hardware, use the correct size tools. DO NOT use U.S. measurement tools on metric fasteners. Avoid bodily injury caused by slipping wrenches.

Use only recommended replacement parts.(see Parts catalogue.)

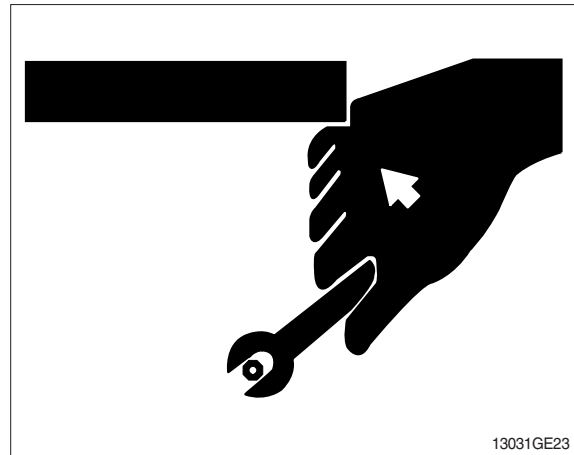

13031GE23

DISPOSE OF FLUIDS PROPERLY

Improperly disposing of fluids can harm the environment and ecology. Before draining any fluids, find out the proper way to dispose of waste from your local environmental agency.

Use proper containers when draining fluids. Do not use food or beverage containers that may mislead someone into drinking from them.

DO NOT pour oil into the ground, down a drain, or into a stream, pond, or lake. Observe relevant environmental protection regulations when disposing of oil, fuel, coolant, brake fluid, filters, batteries, and other harmful waste.

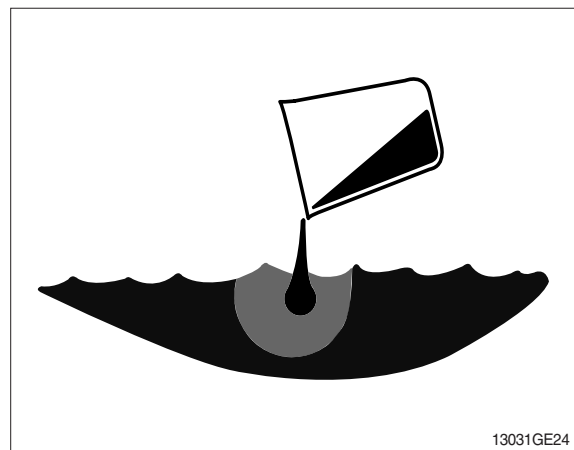

13031GE24

REPLACE SAFETY SIGNS

Replace missing or damaged safety signs. See the machine operator's manual for correct safety sign placement.

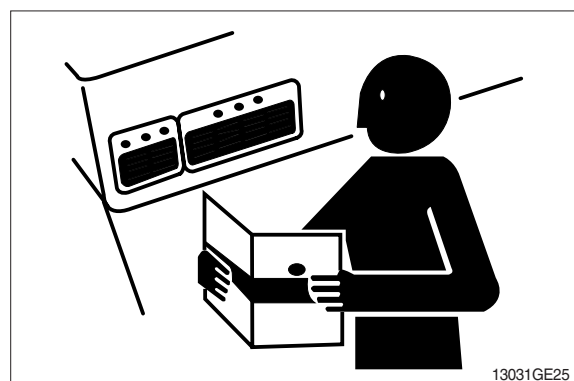

13031GE25

LIVE WITH SAFETY

Before returning machine to customer, make sure machine is functioning properly, especially the safety systems. Install all guards and shields.

GROUP 2 SPECIFICATIONS

1. MAJOR COMPONENT

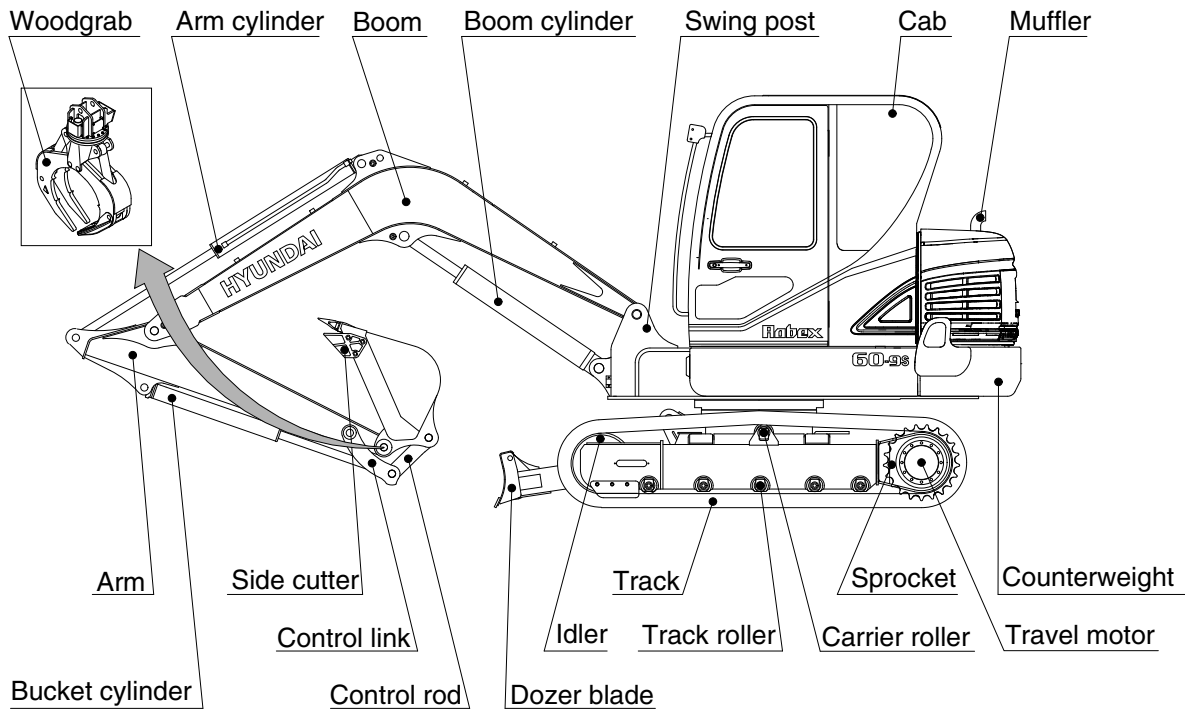
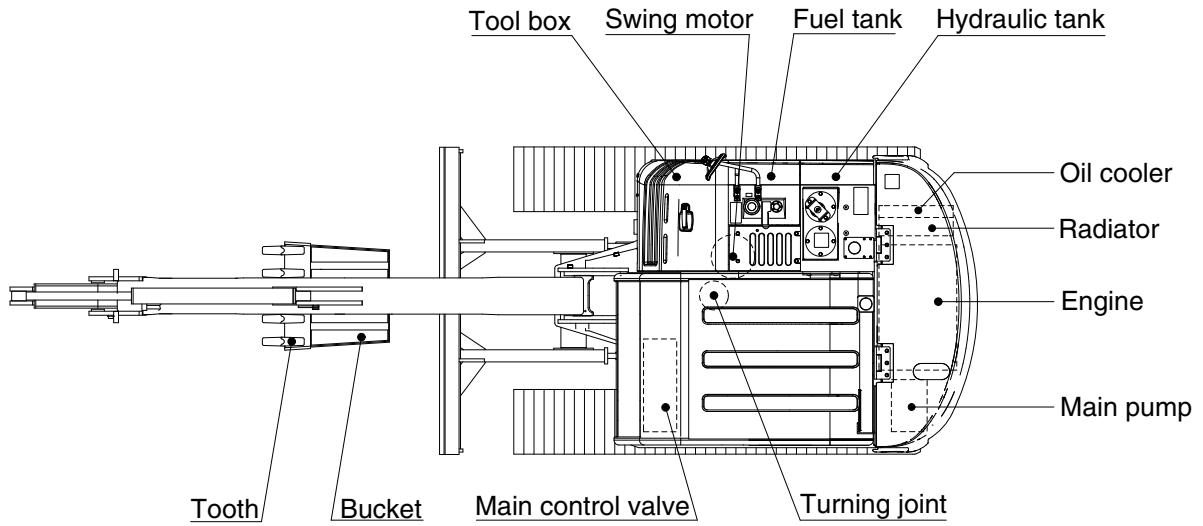

559S2SP01

2. SPECIFICATIONS

1) 3.0 m (9' 10") MONO BOOM, 1.6 m (5' 3") ARM, WITH BOOM SWING SYSTEM

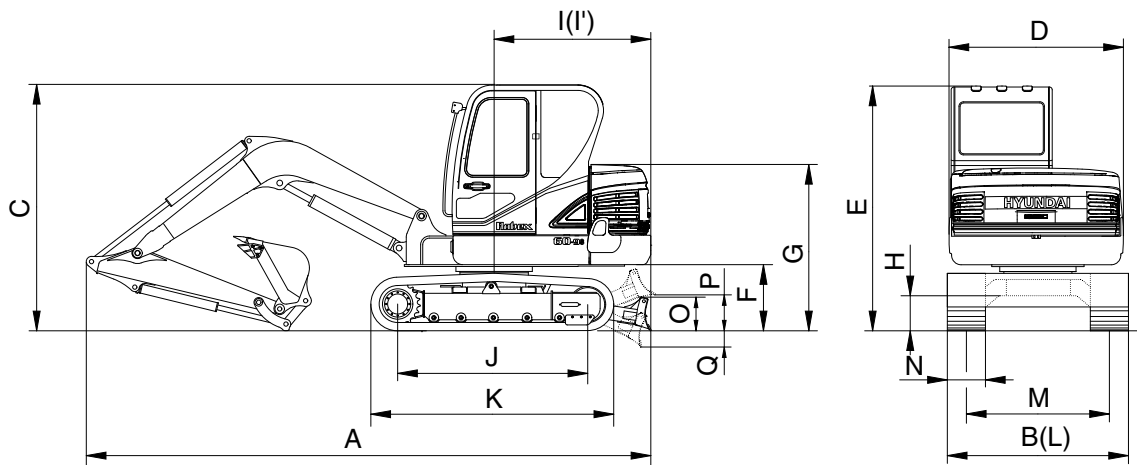

559S2SP02

Description		Unit	Specification	
Operating weight		kg (lb)	5650 (12460)	
Bucket capacity (SAE heaped), standard		m ³ (yd ³)	0.18 (0.24)	
Overall length	A	mm (ft-in)	5900 (19' 4")	
Overall width, with 380 mm shoe	B		1920 (6' 4")	
Overall height	C		2550 (8' 4")	
Superstructure width	D		1850 (6' 1")	
Overall height of cab	E		2550 (8' 4")	
Ground clearance of counterweight	F		690 (2' 3")	
Engine cover height	G		1690 (5' 7")	
Minimum ground clearance	H		380 (1' 3")	
Rear-end distance	I		1650 (5' 5")	
Rear-end swing radius	I'		1650 (5' 5")	
Distance between tumblers	J		1990 (6' 6")	
Undercarriage length	K		2530 (8' 4")	
Undercarriage width	L		1880 (6' 2")	
Track gauge	M		1500 (4' 11")	
Track shoe width, standard	N		380 (15")	
Height of blade	O		350 (1' 2")	
Ground clearance of blade up	P		390 (1' 3")	
Depth of blade down	Q		590 (1' 11")	
Travel speed (low/high)			km/hr (mph)	2.2/4.0 (1.4/2.5)
Swing speed			rpm	9.3
Gradeability		Degree (%)	35 (70)	
Ground pressure (380 mm shoe)		kgf/cm ² (psi)	0.34 (4.83)	
Max traction force		kg (lb)	5300 (11680)	

3. WORKING RANGE

1) 3.0 m (9' 10") MONO BOOM WITH BOOM SWING SYSTEM

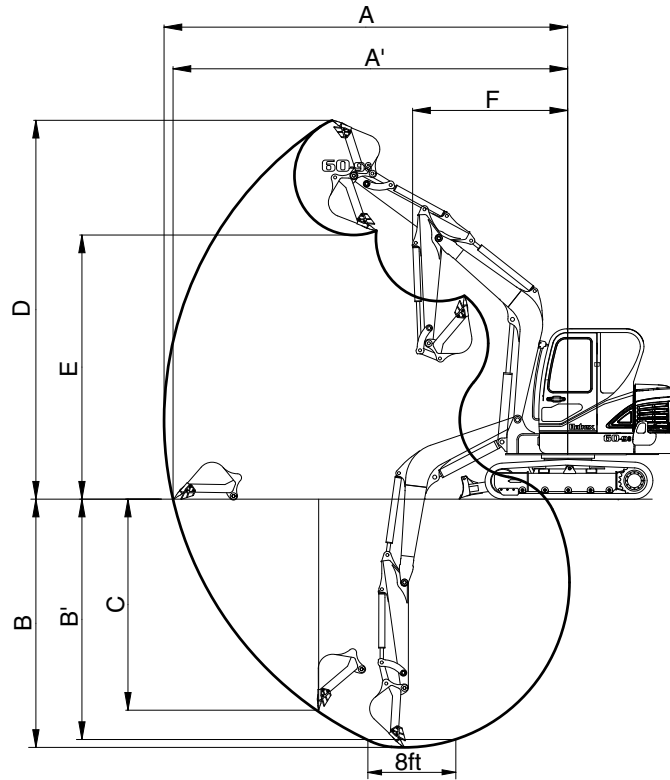

559S2SP03

Description		1.6 m (5' 3") Arm
Max digging reach	A	6150 mm (25' 5")
Max digging reach on ground	A'	6010 mm (24'11")
Max digging depth	B	3820 mm (16' 2")
Max digging depth (8ft level)	B'	3420 mm (15' 4")
Max vertical wall digging depth	C	3200 mm (15' 3")
Max digging height	D	5780 mm (26' 7")
Max dumping height	E	4050 mm (18' 7")
Min swing radius	F	2350 mm (8' 8")
Boom swing radius (left/right)		80°/50°
Bucket digging force	SAE	37.7 kN
		3850 kgf
		8490 lbf
	ISO	42.4 kN
		4330 kgf
		9550 lbf
Arm crowd force	SAE	28.4 kN
		2900 kgf
		6390 lbf
	ISO	31.9 kN
		3260 kgf
		7190 lbf











4. WEIGHT

Item	kg	lb
Upperstructure assembly	2710	5970
Main frame weld assembly	600	1320
Engine assembly	280	620
Main pump assembly	30	70
Main control valve assembly	40	90
Swing motor assembly	80	180
Hydraulic oil tank assembly	90	200
Fuel tank assembly	60	130
Boom swing post	110	240
Counterweight	235	520
Cab assembly	350	770
Lower chassis assembly	2150	4740
Track frame weld assembly	700	1540
Swing bearing	94	210
Travel motor assembly	80	180
Turning joint	28	62
Track recoil spring	17	37
Idler & tension body	56	120
Carrier roller	12	26
Track roller	12	26
Sprocket	17	37
Track-chain assembly (380 mm standard triple grouser shoe)	325	720
Dozer blade assembly	210	460
Front attachment assembly (3.0 m boom, 1.6 m arm, 0.18 m ³ SAE heaped bucket)	790	1740
3.0 m boom assembly	240	530
1.6 m arm assembly	130	290
0.18 m ³ SAE heaped bucket	170	370
Boom cylinder assembly	70	155
Arm cylinder assembly	60	130
Bucket cylinder assembly	35	80
Bucket control link assembly	40	90
Dozer cylinder assembly	40	90
Boom swing cylinder assembly	40	90

5. LIFTING CAPACITIES

1) 3.0 m (9' 10") boom, 1.6 m (5' 3") arm equipped with 0.18 m³ (SAE heaped) bucket and 380 mm (15") triple grouser shoe, the dozer blade down.











-  : Rating over-front
-  : Rating over-side or 360 degree

Load point height		Load radius								At max. reach		
		2.0 m (7 ft)		3.0 m (10 ft)		4.0 m (13 ft)		5.0 m (16 ft)		Capacity		Reach
												m (ft)
5.0 m (16 ft)	kg									*950	*950	4.12
	lb									*2090	*2090	(13.5)
4.0 m (13 ft)	kg					*1020	*1020			*980	780	5.08
	lb					*2250	*2250			*2160	1720	(16.7)
3.0 m (10 ft)	kg					*1090	*1090			*1010	650	5.60
	lb					*2400	*2400			*2230	1430	(18.4)
2.0 m (7 ft)	kg	*3050	*3050	*1690	*1690	*1320	1100	*1170	760	*1050	590	5.84
	lb	*6720	*6720	*3730	*3730	*2910	2430	*2580	1680	*2310	1300	(19.2)
1.0 m (3 ft)	kg			*2360	1610	*1600	1040	*1280	740	*1100	580	5.85
	lb			*5200	3550	*3530	2290	*2820	1630	*2430	1280	(19.2)
Ground Line	kg	*2350	*2350	*2700	1540	*1790	1000	*1350	720	*1140	610	5.63
	lb	*5180	*5180	*5950	3400	*3950	2200	*2980	1590	*2510	1340	(18.5)
-1.0 m (-3 ft)	kg	*3600	3020	*2670	1530	*1800	990			*1180	700	5.13
	lb	*7940	6660	*5890	3370	*3970	2180			*2600	1540	(16.8)
-2.0 m (-7 ft)	kg	*3770	3060	*2300	1540					*1140	960	4.23
	lb	*8310	6750	*5070	3400					*2510	2120	(13.9)
-3.0 m (-10 ft)	kg	*2040	*2040									
	lb	*4500	*4500									

- Note
1. Lifting capacity are based on SAE J1097 and ISO 10567.
 2. Lifting capacity of the ROBEX series does not exceed 75% of tipping load with the machine on firm, level ground or 87% of full hydraulic capacity.
 3. The load point is a hook located on the back of the bucket.
 4. *indicates load limited by hydraulic capacity.

2) 3.0 m (9'10") boom, 1.6 m (5' 3") arm equipped with 0.18 m³ (SAE heaped) bucket and 380 mm (15") triple grouser shoe, the dozer blade up.

-  : Rating over-front
-  : Rating over-side or 360 degree

Load point height		Load radius								At max. reach		
		2.0 m (7 ft)		3.0 m (10 ft)		4.0 m (13 ft)		5.0 m (16 ft)		Capacity		Reach m (ft)
												
5.0 m (16 ft)	kg lb									*950 *2090	*950 *2090	4.12 (13.5)
4.0 m (13 ft)	kg lb					*1020 *2250	*1020 *2250			*980 *2160	740 1630	5.08 (16.7)
3.0 m (10 ft)	kg lb					*1090 *2400	1080 2380			890 1960	610 1340	5.60 (18.4)
2.0 m (7 ft)	kg lb	*3050 *6720	*3050 *6720	*1690 *3730	1630 3590	*1320 *2910	1030 2270	1040 2290	710 1570	810 1790	550 1210	5.84 (19.2)
1.0 m (3 ft)	kg lb			2250 4960	1510 3330	1430 3150	980 2160	1010 2230	690 1520	800 1760	540 1190	5.85 (19.2)
Ground Line	kg lb	*2350 *5180	*2350 *5180	2170 4780	1440 3170	1390 3060	940 2070	990 2180	670 1480	840 1850	570 1260	5.63 (18.5)
-1.0 m (-3 ft)	kg lb	*3600 *7940	2780 6130	2150 4740	1420 3130	1370 3020	930 2050			970 2140	660 1460	5.13 (16.8)
-2.0 m (-7 ft)	kg lb	*3770 *8310	2830 6240	2170 4780	1440 3170					*1140 *2510	900 1980	4.23 (13.9)
-3.0 m (-10 ft)	kg lb	*2040 *4500	*2040 *4500									

6. BUCKET SELECTION GUIDE

1) GENERAL BUCKET

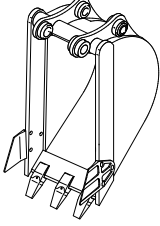
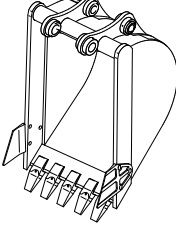
	
<p>0.07m³ SAE heaped bucket</p>	<p>0.18 m³ SAE heaped bucket</p>

Capacity		Width		Weight	Recommendation
SAE heaped	CECE heaped	Without side cutter	With side cutter		3.0 m (9' 10") boom
					1.6 m (5' 3") arm
0.07 m ³ (0.09 yd ³)	0.06 m ³ (0.08 yd ³)	315 mm (12.4")	360 mm (14.2")	115 kg (255 lb)	Applicable for materials with density of 1600 kgf/m ³ (2700 lb/yd ³) or less
0.18 m ³ (0.24 yd ³)	0.15 m ³ (0.20 yd ³)	670 mm (26.4")	740 mm (29.1")	170 kg (375 lb)	

7. UNDERCARRIAGE

1) TRACKS

X-leg type center frame is integrally welded with reinforced box-section track frames. The design includes dry tracks, lubricated rollers, idlers, sprockets, hydraulic track adjusters with shock absorbing springs and assembled track-type tractor shoes with triple grousers.

2) TYPES OF SHOES

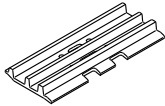
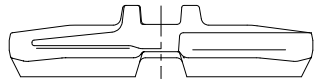
Model	Shapes		Steel track	Rubber track
				
R60-9S	Shoe width	mm (in)	380 (15)	400 (16)
	Operating weight	kg (lb)	5650 (12460)	5670 (12500)
	Ground pressure	kgf/cm ² (psi)	0.34 (4.83)	0.33 (4.69)
	Overall width	mm (ft-in)	1880 (6' 2")	1900 (6' 3")

3) NUMBER OF ROLLERS AND SHOES ON EACH SIDE

Item	Quantity
Carrier rollers	1 EA
Track rollers	5 EA
Track shoes	40 EA

8. SPECIFICATIONS FOR MAJOR COMPONENTS

1) ENGINE

Item	Specification
Model	Yanmar 4TNV94L-XHYB2
Type	4-cycle diesel engine, low emission
Cooling method	Water cooling
Number of cylinders and arrangement	4 cylinders, in-line
Firing order	1-3-4-2
Combustion chamber type	Direct injection type
Cylinder bore×stroke	94 × 110 mm (3.7" × 4.33")
Piston displacement	3054 cc (186 cu in)
Compression ratio	19 : 1
Rated gross horse power (SAE J1995)	53 Hp at 2200 rpm (52 Hp/40 kW at 2200 rpm)
Maximum torque at 1400 rpm	20.6 kgf · m (149 lbf · ft)
Engine oil quantity	11.6 l (3.1 U.S. gal)
Dry weight	280 kg (617 lb)
High idling speed	2200 ± 50 rpm
Low idling speed	1000 ± 100 rpm
Rated fuel consumption	172.6 g/Hp · hr at 2200 rpm
Starting motor	12 V-3.0 kW
Alternator	12 V-100 A
Battery	1 × 12 V × 100 Ah

2) MAIN PUMP

Item	Specification
Type	Variable displacement tandem axis piston pumps
Capacity	2 × 27.5 cc/rev
Maximum pressure	220 kgf/cm ² (3130 psi)
Rated oil flow	2 × 55 l /min (14.5 U.S. gpm / 12.1 U.K. gpm)
Rated speed	2200 rpm

3) GEAR PUMP

Item	Specification
Type	Fixed displacement gear pump single stage
Capacity	18.3+4.5 cc/rev
Maximum pressure	220/30 kgf/cm ² (3130/430 psi)
Rated oil flow	36.6/9.0 l /min (9.7/2.4 U.S. gpm / 8.0/2.0 U.K. gpm)

4) MAIN CONTROL VALVE

Item	Specification
Type	Sectional, 9 spools+1 option
Operating method	Hydraulic pilot system
Main relief valve pressure	220 kgf/cm ² (3130 psi)
Overload relief valve pressure	240 kgf/cm ² (3410 psi)

[] : Power boost

5) SWING MOTOR

Item	Specification
Type	Fixed displacement axial piston motor
Capacity	32.3 cc/rev
Relief pressure	220 kgf/cm ² (3130 psi)
Braking system	Automatic, spring applied hydraulic released
Braking torque	14 kgf · m (101 lbf · ft)
Brake release pressure	20~40 kgf/cm ² (284~570 psi)
Reduction gear type	2 - stage planetary

6) TRAVEL MOTOR

Item	Specification
Type	Variable displacement axial piston motor
Relief pressure	220 kgf/cm ² (3130 psi)
Reduction gear type	2-stage planetary
Braking system	Automatic, spring applied hydraulic released
Brake release pressure	9 kgf/cm ² (128 psi)
Braking torque	8.4 kgf · m (61 lbf · ft)

7) CYLINDER

Item		Specification
Boom cylinder	Bore dia × Rod dia × Stroke	ø 110 × ø 60 × 715 mm
	Cushion	Extend only
Arm cylinder	Bore dia × Rod dia × Stroke	ø 90 × ø 55 × 850 mm
	Cushion	Extend and retract
Bucket cylinder	Bore dia × Rod dia × Stroke	ø 80 × ø 50 × 660 mm
Dozer blade cylinder	Bore dia × Rod dia × Stroke	ø 110 × ø 60 × 224 mm
Boom swing cylinder	Bore dia × Rod dia × Stroke	ø 95 × ø 50 × 527 mm

- ※ Discoloration of cylinder rod can occur when the friction reduction additive of lubrication oil spreads on the rod surface.
- ※ Discoloration does not cause any harmful effect on the cylinder performance.

8) SHOE

Item	Width	Ground pressure	Link quantity	Overall width
R60-9S	380 mm (15")	0.34 kgf/cm ² (4.83 psi)	40	1880 mm (6' 2")

9) BUCKET

Item		Capacity		Tooth quantity	Width	
		SAE heaped	CECE heaped		Without side cutter	With side cutter
R60-9S	STD	0.18 m ³ (0.24 yd ³)	0.15 m ³ (0.20 yd ³)	5	670 mm (26.4")	740 mm (29.1")
	OPT	0.07 m ³ (0.09 yd ³)	0.06 m ³ (0.08 yd ³)	3	315 mm (12.4")	360 mm (14.2")

9. RECOMMENDED OILS

Use only oils listed below. Do not mix different brand oil.

Please use HYUNDAI genuine oil and grease.

Service point	Kind of fluid	Capacity l (U.S. gal)	Ambient temperature °C (°F)					
			-20 (-4)	-10 (14)	0 (32)	10 (50)	20 (68)	30 (86)
Engine oil pan	Engine oil	11.6 (3.1)	SAE 30					
			SAE 10W					
			SAE 10W-30					
						SAE 15W-40		
Swing drive	Grease	0.2 (0.05)	NLGI NO.1					
						NLGI NO.2		
	Gear oil	1.5 (0.4)	SAE 80W-90					
Final drive	Gear oil	1.2 × 2 (0.3 × 2)						
Hydraulic tank	Hydraulic oil	Tank : 70 (18.5) System : 120 (31.7)	ISO VG 32					
						ISO VG 46		
						ISO VG 68		
Fuel tank	Diesel fuel	120 (31.7)	ASTM D975 NO.1					
						ASTM D975 NO.2		
Fitting (Grease nipple)	Grease	As required	NLGI NO.1					
						NLGI NO.2		
Radiator (Reservoir tank)	Mixture of antifreeze and water 50 : 50	9.5 (2.5)	Ethylene glycol base permanent type					

SAE : Society of Automotive Engineers

API : American Petroleum Institute

ISO : International Organization for Standardization

NLGI : National Lubricating Grease Institute

ASTM : American Society of Testing and Material