

SECTION 9 COMPONENT MOUNTING TORQUE

Group 1 Introduction guide	9-1
Group 2 Engine system	9-2
Group 3 Electric system	9-4
Group 4 Hydraulic system	9-6
Group 5 Undercarriage	9-9
Group 6 Structure	9-10
Group 7 Work equipment	9-14

SECTION 9 COMPONENT MOUNTING TORQUE

GROUP 1 INTRODUCTION GUIDE

1. This section shows bolt specifications and standard torque values needed when mounting components to the machine.
 2. Use genuine Hyundai spare parts.
We expressly point out that Hyundai will not accept any responsibility for defects resulted from non-genuine parts.
In such cases Hyundai cannot assume liability for any damage.
- ※ Only metric fasteners can be used and incorrect fasteners may result in machine damage or malfunction.
 - ※ Before installation, clean all the components with a non-corrosive cleaner. Bolts and threads must not be worn or damaged.

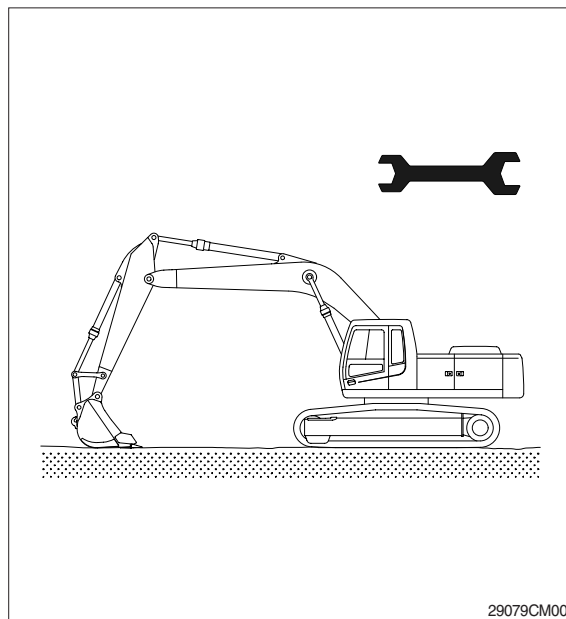

29079CM00