

GROUP 9 ATTACHMENT FLOW CONTROL SYSTEM

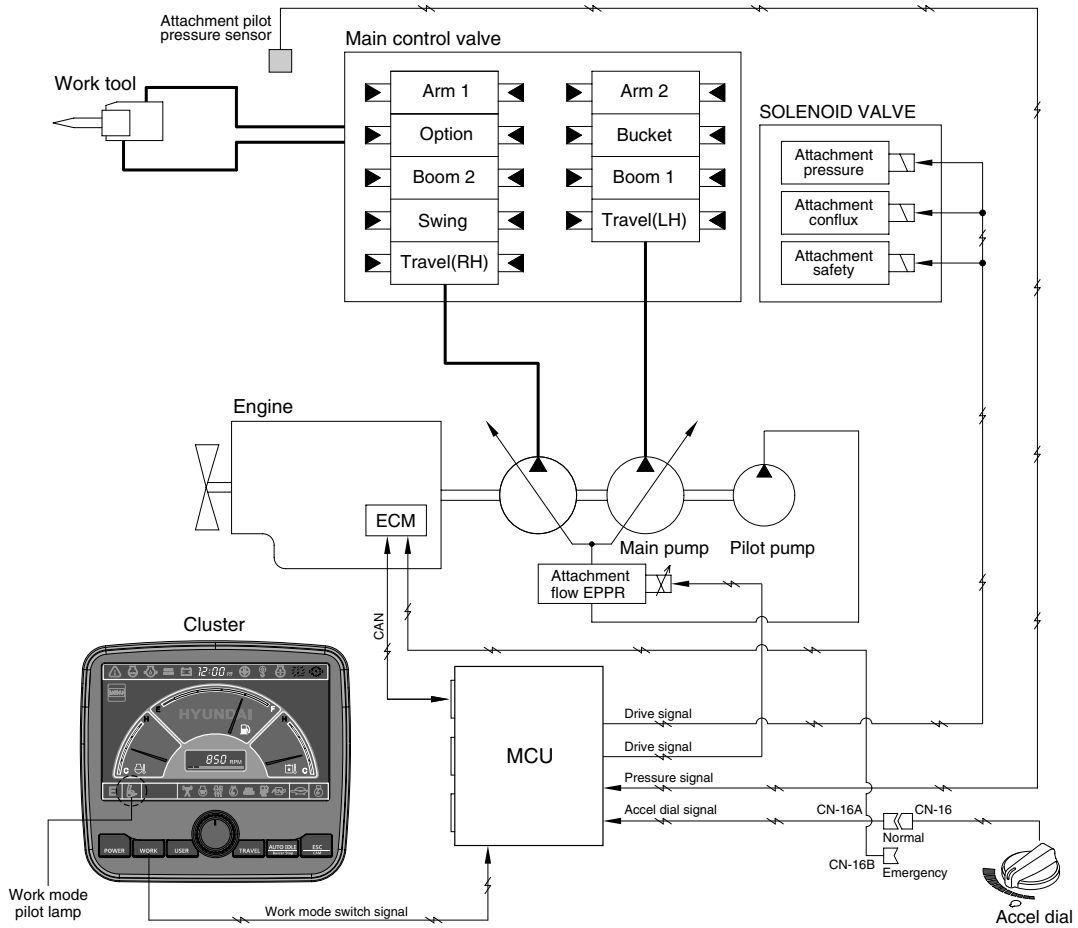

48095MS06

- The system is used to control the pump delivery flow according to set of the work tool on the cluster by the attachment flow EPPR valve.

Description	Work tool	
	Breaker	Crusher
Flow level	Max 7 step, reduced 10 lpm each step	Max 4 step, reduced 20 lpm each step
Attach safety solenoid	ON	ON
Attach pressure solenoid	OFF	ON
Attach conflux solenoid	OFF	ON/OFF

※ Refer to the page 5-45 for the attachment kinds and max flow.