

SECTION 5 MECHATRONICS SYSTEM

Group 1 Outline.....	5-1
Group 2 Mode Selection System	5-3
Group 3 Automatic Deceleration System	5-6
Group 4 Power Boost System	5-7
Group 5 Travel Speed Control System	5-8
Group 6 Automatic Warming Up System	5-9
Group 7 Engine Overheat Prevention System	5-10
Group 8 Variable Power Control System	5-11
Group 9 Attachment Flow Control System	5-12
Group 10 Anti-Restart System	5-13
Group 11 Self-Diagnostic System	5-14
Group 12 Engine Control System	5-39
Group 13 EPPR Valve	5-40
Group 14 Monitoring System	5-45
Group 15 Fuel Warmer System	5-72

SECTION 5 MECHATRONICS SYSTEM

GROUP 1 OUTLINE

The ADVANCED CAPO (Computer Aided Power Optimization) system controls engine and pump mutual power at an optimum and less fuel consuming state for the selected work by mode selection, auto-deceleration, power boost function, etc. It monitors machine conditions, for instance, engine speed, coolant temperature, hydraulic oil temperature, and hydraulic oil pressure, etc.

It consists of a MCU, a cluster, an ECM, EPPR valves, and other components. The MCU and the cluster protect themselves from over-current and high voltage input, and diagnose malfunctions caused by short or open circuit in electric system, and display error codes on the cluster.

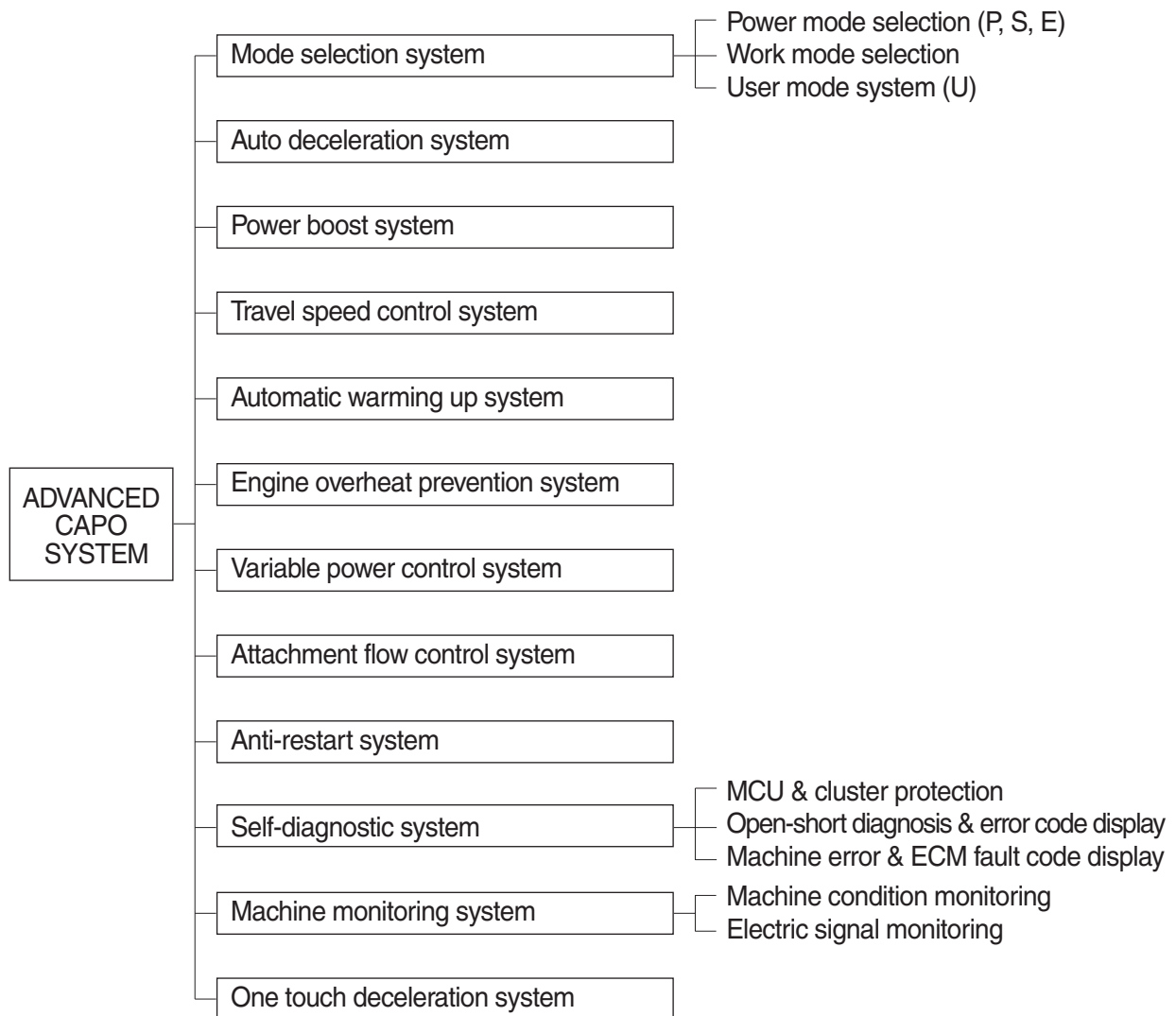

SYSTEM DIAGRAM

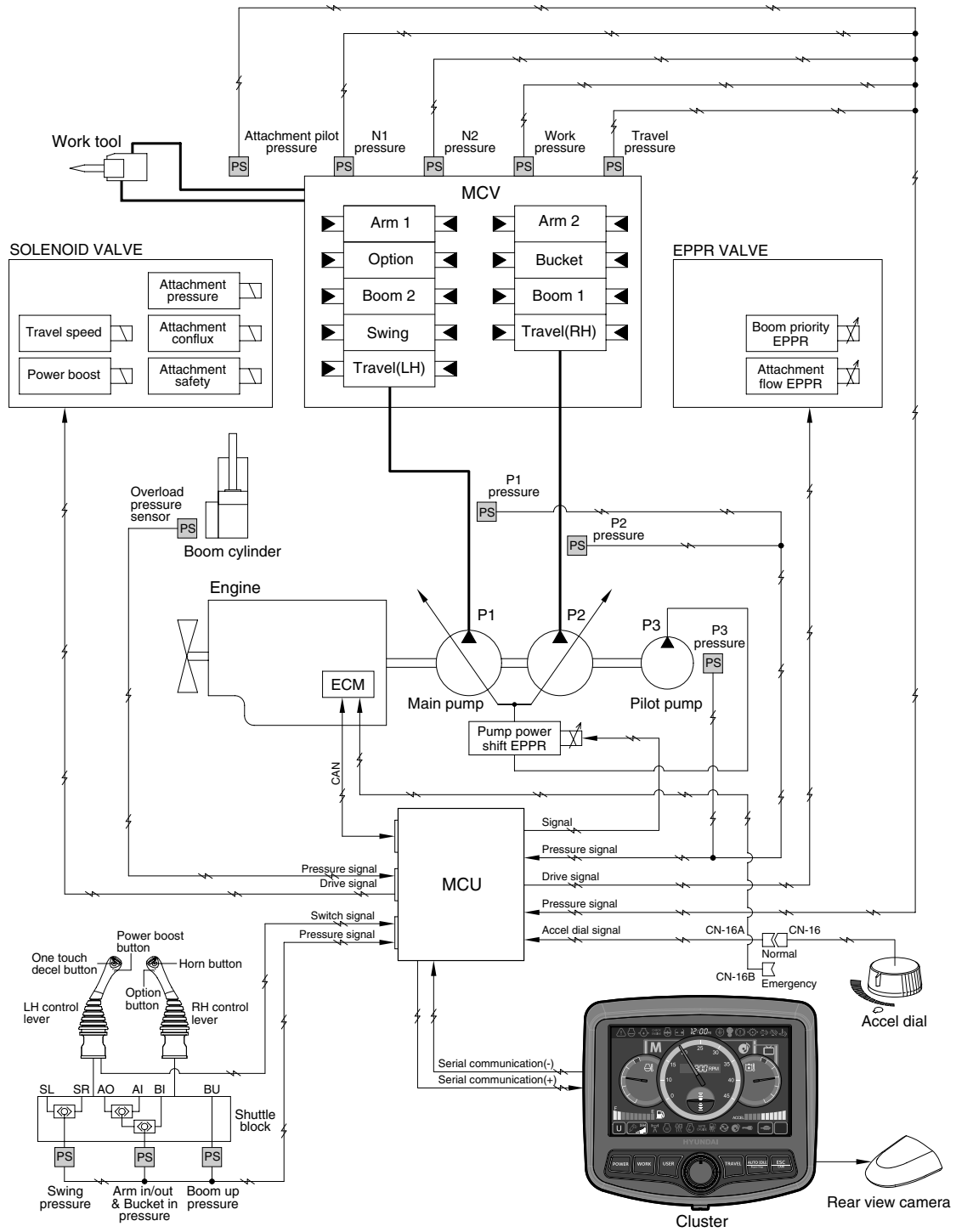

3809A5MS01