

## GROUP 2 HYDRAULIC AND MECHANICAL SYSTEM

### 1. INTRODUCTION

#### 1) MACHINE IN GENERAL

(1) If even a minor fault is left intact and operation is continued, a fatal failure may be caused, entailing a large sum of expenses and long hours of restoration.

Therefore when even a small trouble occurs, do not rely on your intuition and experience, but look for the cause based on the troubleshooting principle and perform maintenance and adjustment to prevent major failure from occurring. Keep in mind that a fault results from a combination of different causes.

(2) The following lists up commonly occurring faults and possible causes with this machine. For the troubleshooting of the engine, refer to the coming troubleshooting and repair.

(3) When carrying out troubleshooting, do not hurry to disassemble the components. It will become impossible to find the cause of the problem.

(4) Ask user or operator the following.

- ① Was there any strange thing about machine before failure occurred?
- ② Under what conditions did the failure occur?
- ③ Have any repairs been carried out before the failure?

(5) Check before troubleshooting.

- ① Check oil and fuel level.
- ② Check for any external leakage of oil from components.
- ③ Check for loose or damage of wiring and connections.

#### 2) MACHINE STATUS MONITORING ON THE CLUSTER

(1) The machine status such as the engine rpm, oil temperature, voltage and pressure etc. can be checked by this menu.

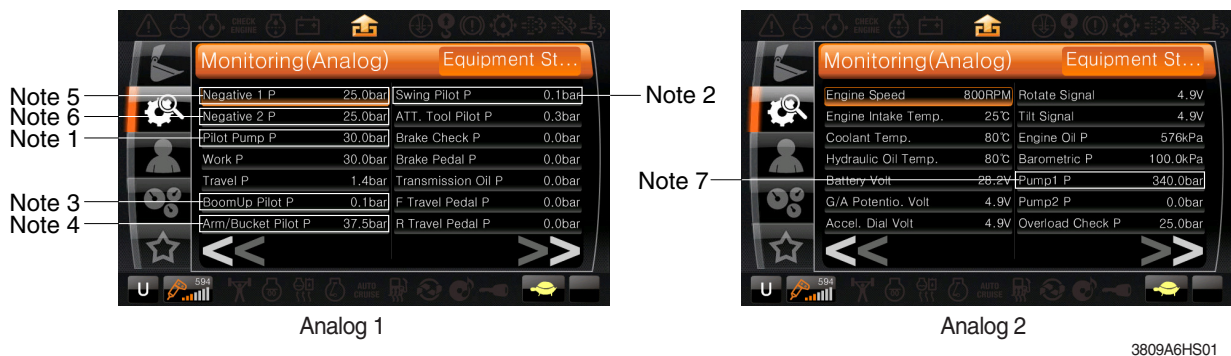

#### (2) Specification

No.	Description	Specification
Note 1	Pilot pump pressure	40 <sup>+2</sup> <sub>0</sub> bar
Note 2	Swing pilot pressure	0~40 bar
Note 3	Boom up pilot pressure	0~40 bar
Note 4	Arm/bucket pilot pressure	0~40 bar
Note 5	P1 pump control pressure	0~25 bar
Note 6	P2 pump control pressure	0~25 bar
Note 7	Pump 1 pressure	350 bar

## 2. DRIVE SYSTEM

### 1) UNUSUAL NOISE COMES OUT OF PUMP CONNECTION

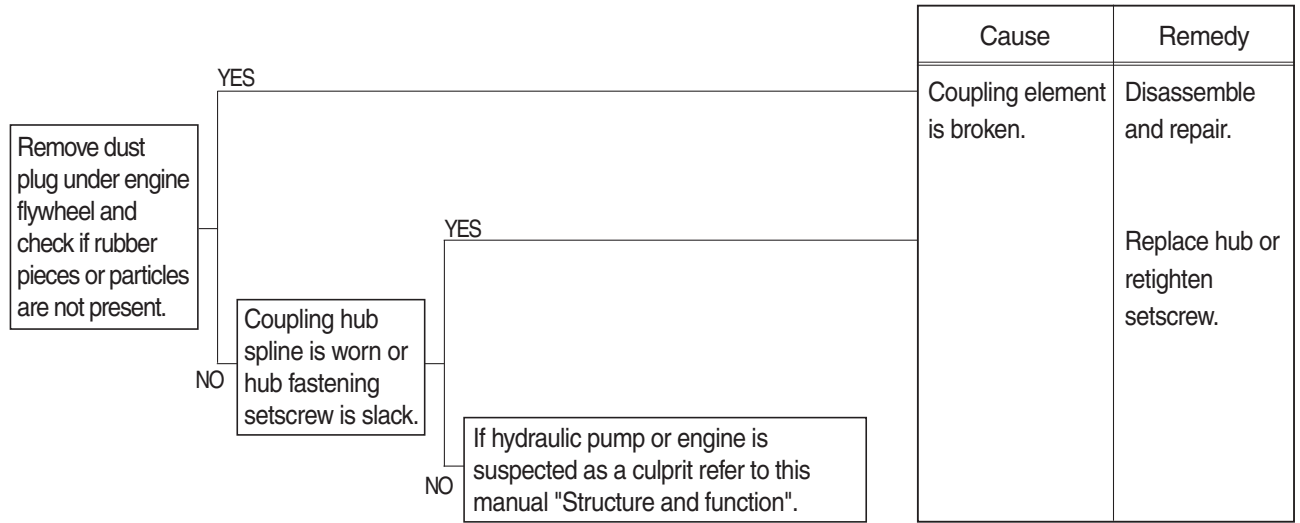

## 2) ENGINE STARTS BUT MACHINE DOES NOT OPERATE AT ALL

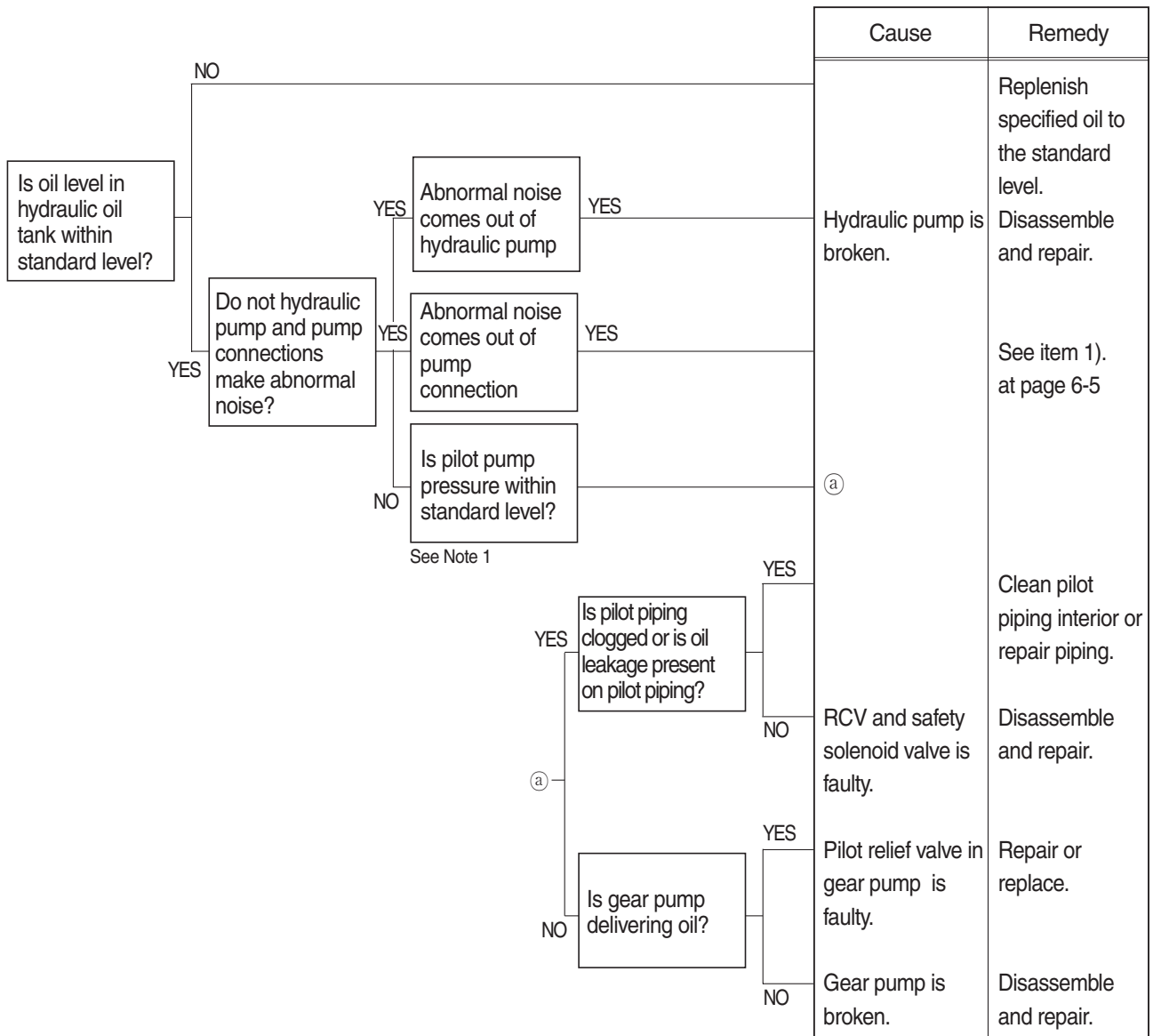

### 3. HYDRAULIC SYSTEM

#### 1) HYDRAULIC OIL IS CLOUDY

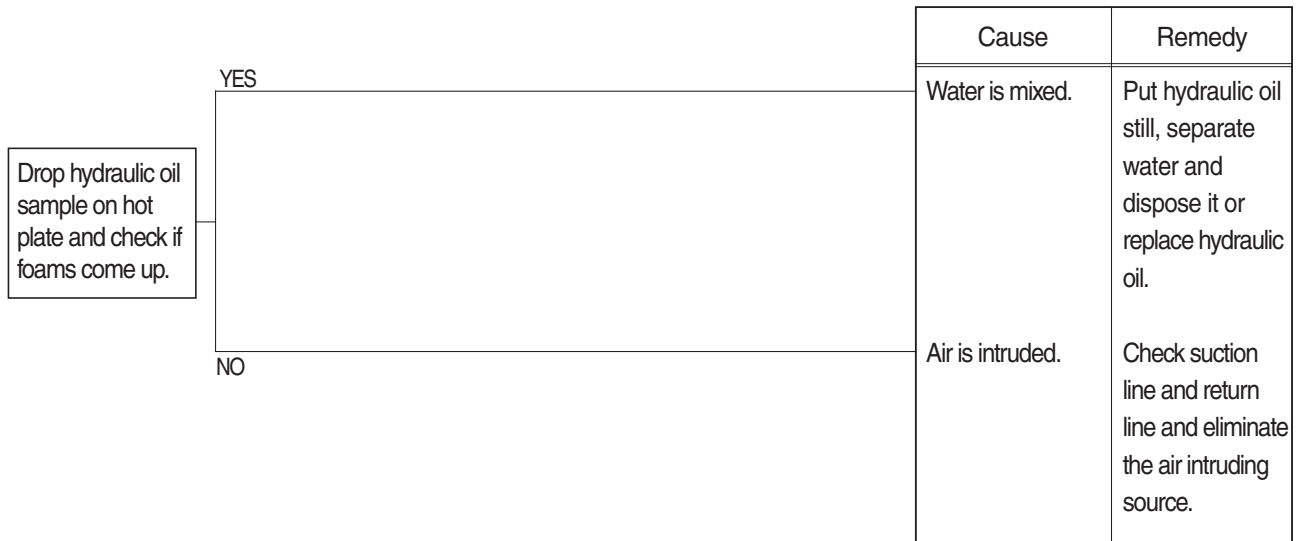

#### 2) HYDRAULIC OIL TEMPERATURE HAS RISEN ABNORMALLY

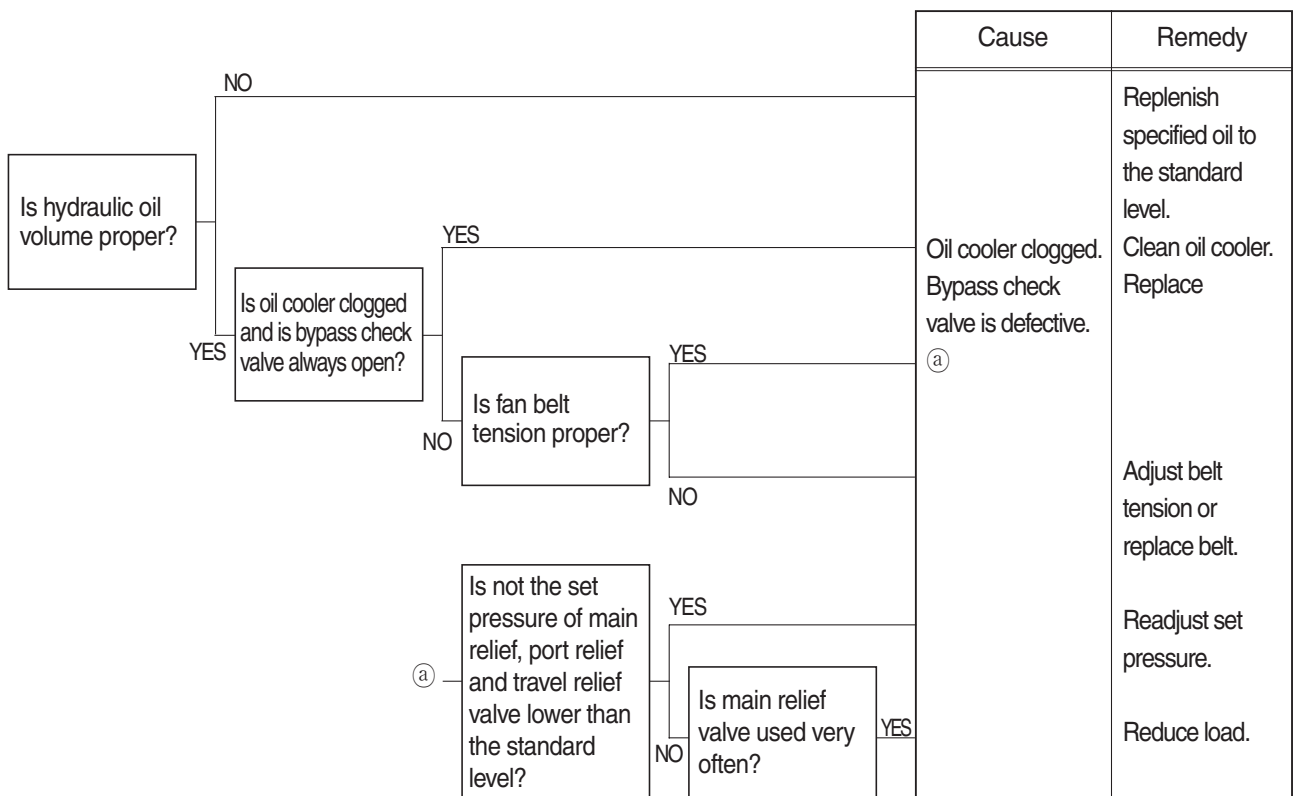

### 3) CAVITATION OCCURS WITH PUMP

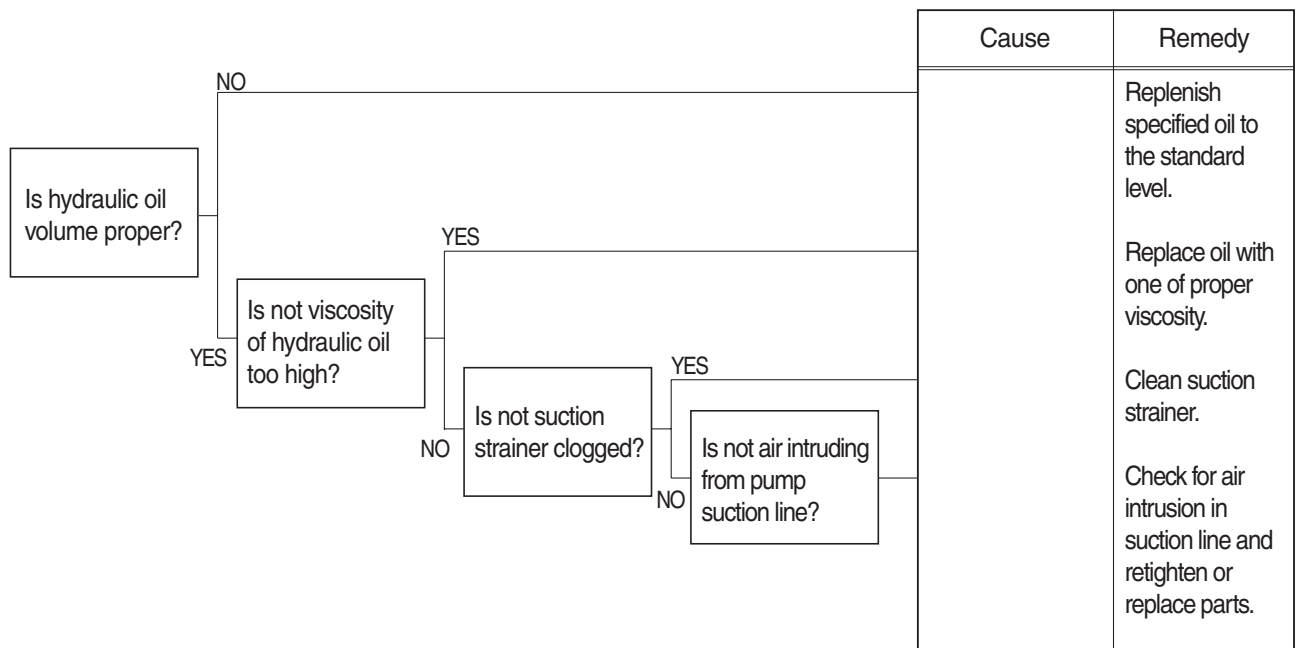

### 4) HYDRAULIC OIL IS CONTAMINATED

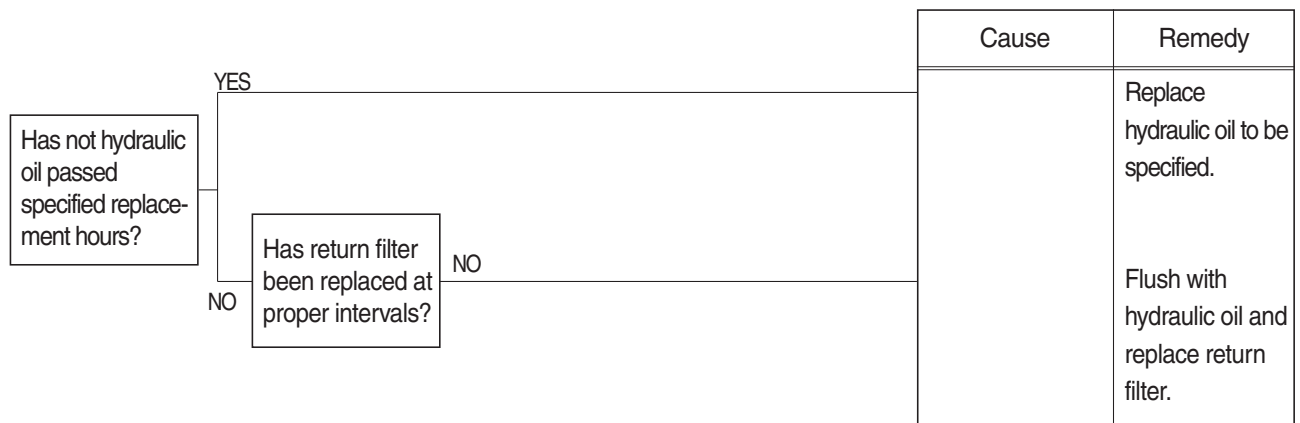

## 4. SWING SYSTEM

### 1) BOTH LH AND RH SWING ACTIONS ARE IMPOSSIBLE

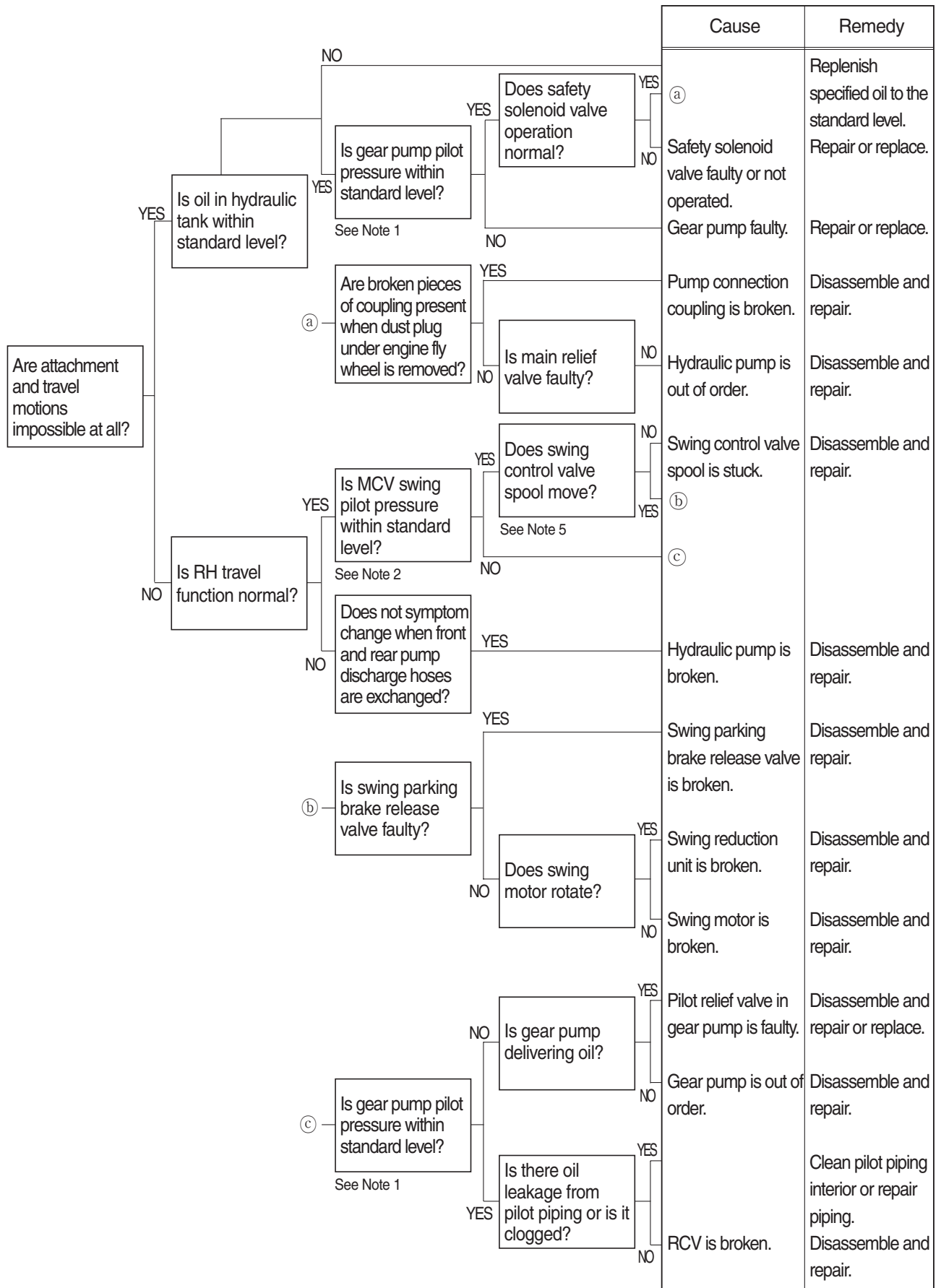

## 2) SWING SPEED IS LOW

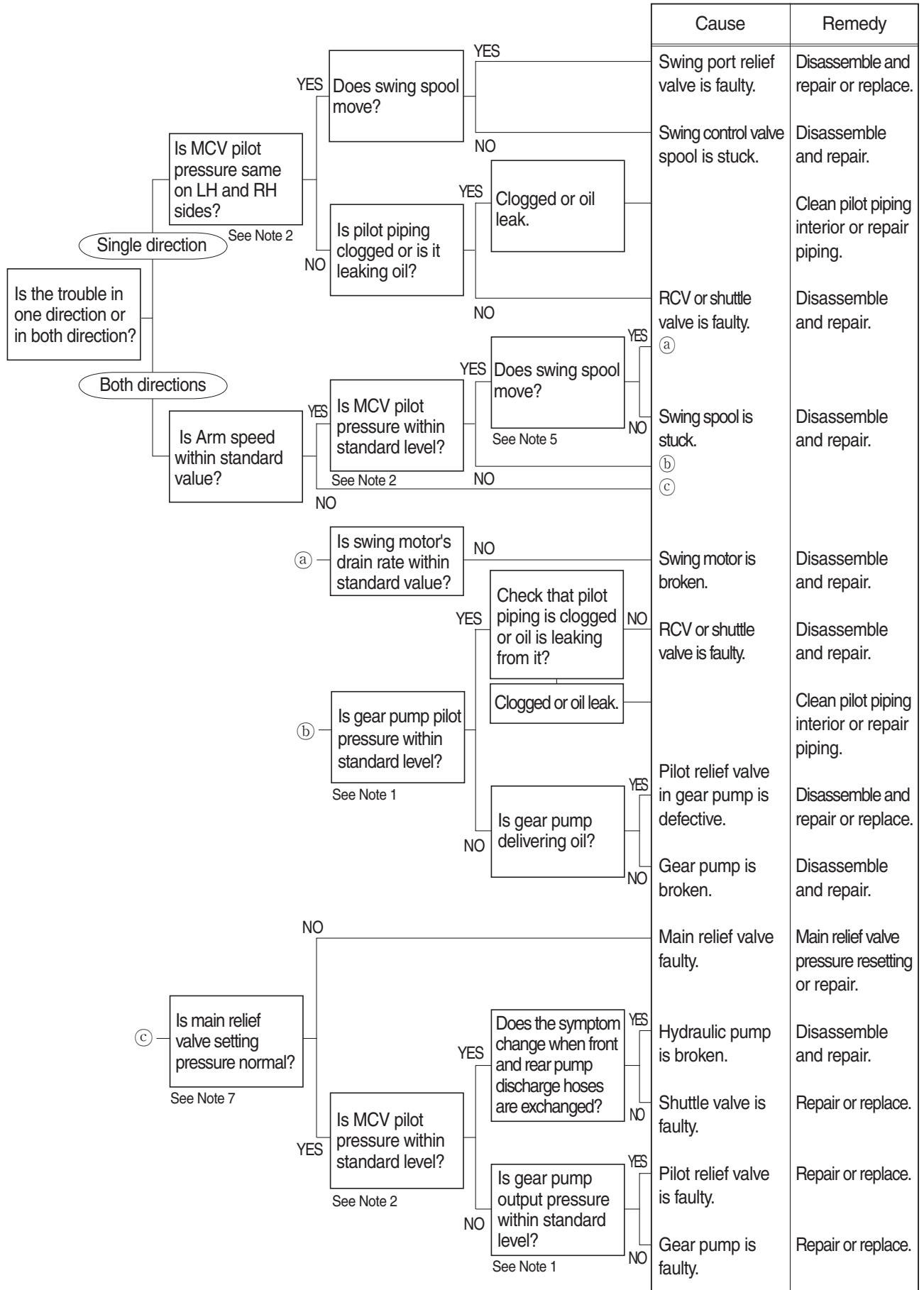

### 3) SWING MOTION IS IMPOSSIBLE IN ONE DIRECTION

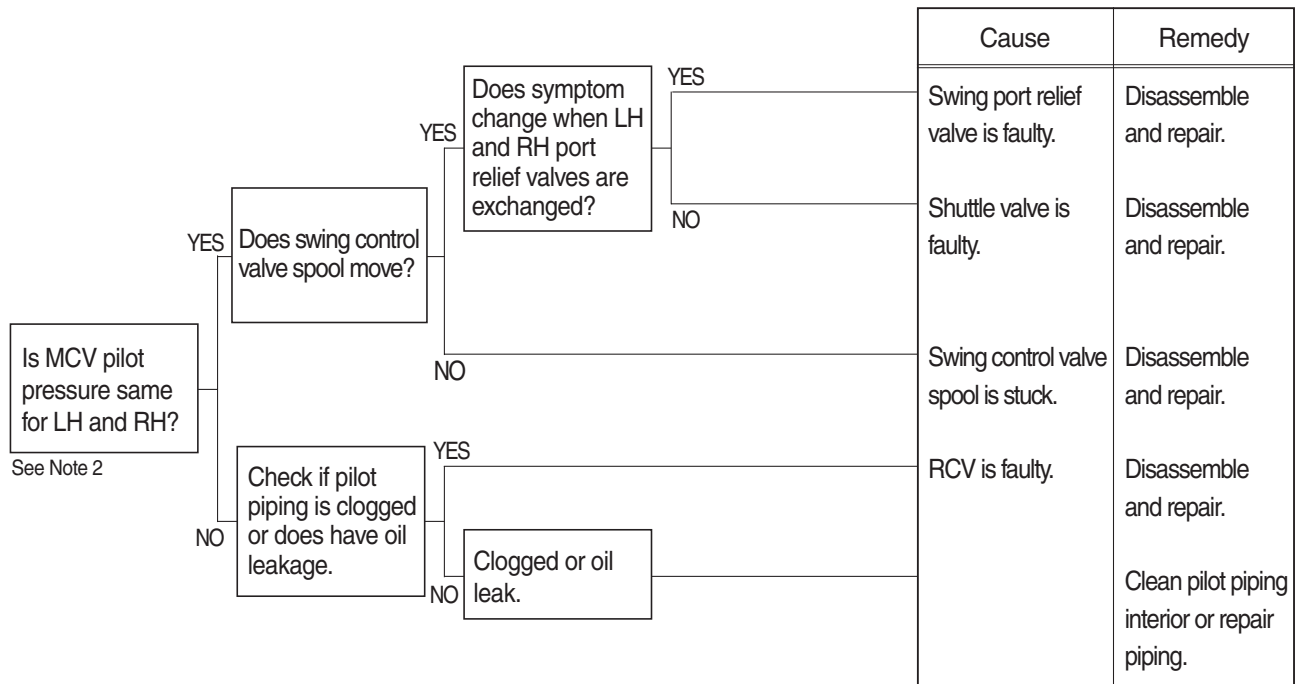

### 4) MACHINE SWINGS BUT DOES NOT STOP

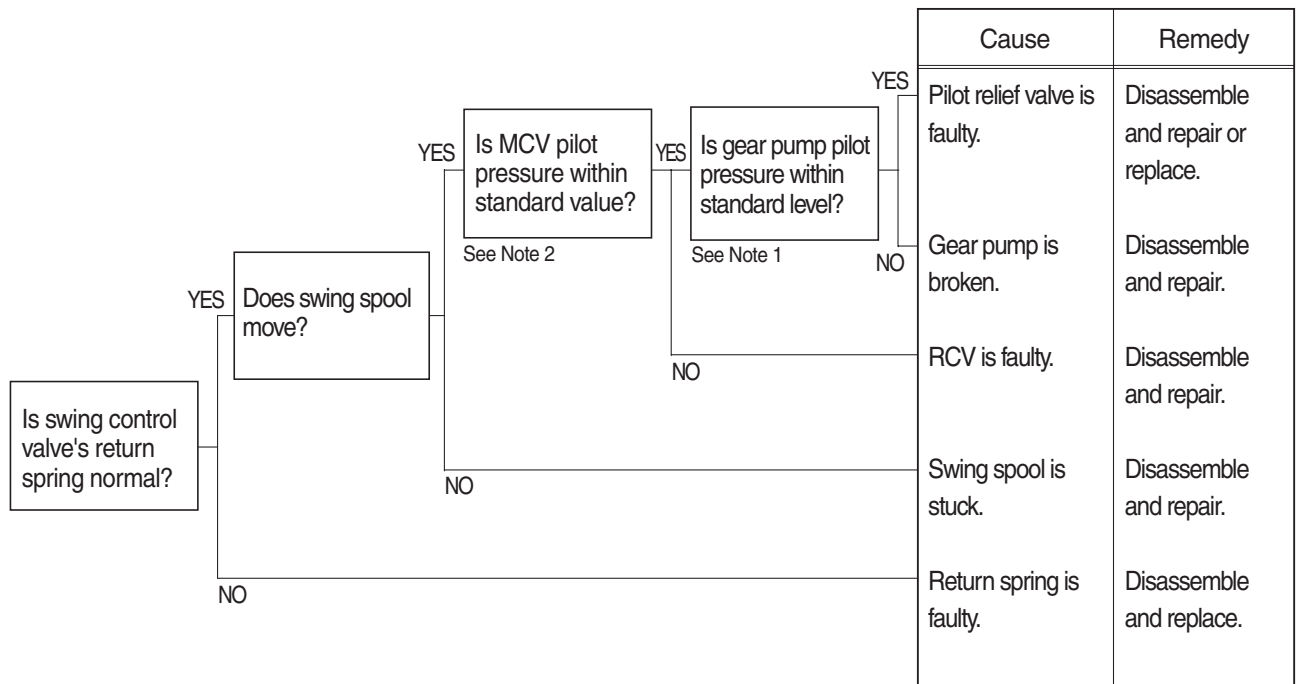



5) THE SWING UNIT DRIFTS WHEN THE MACHINE IS AT REST ON A SLOPE

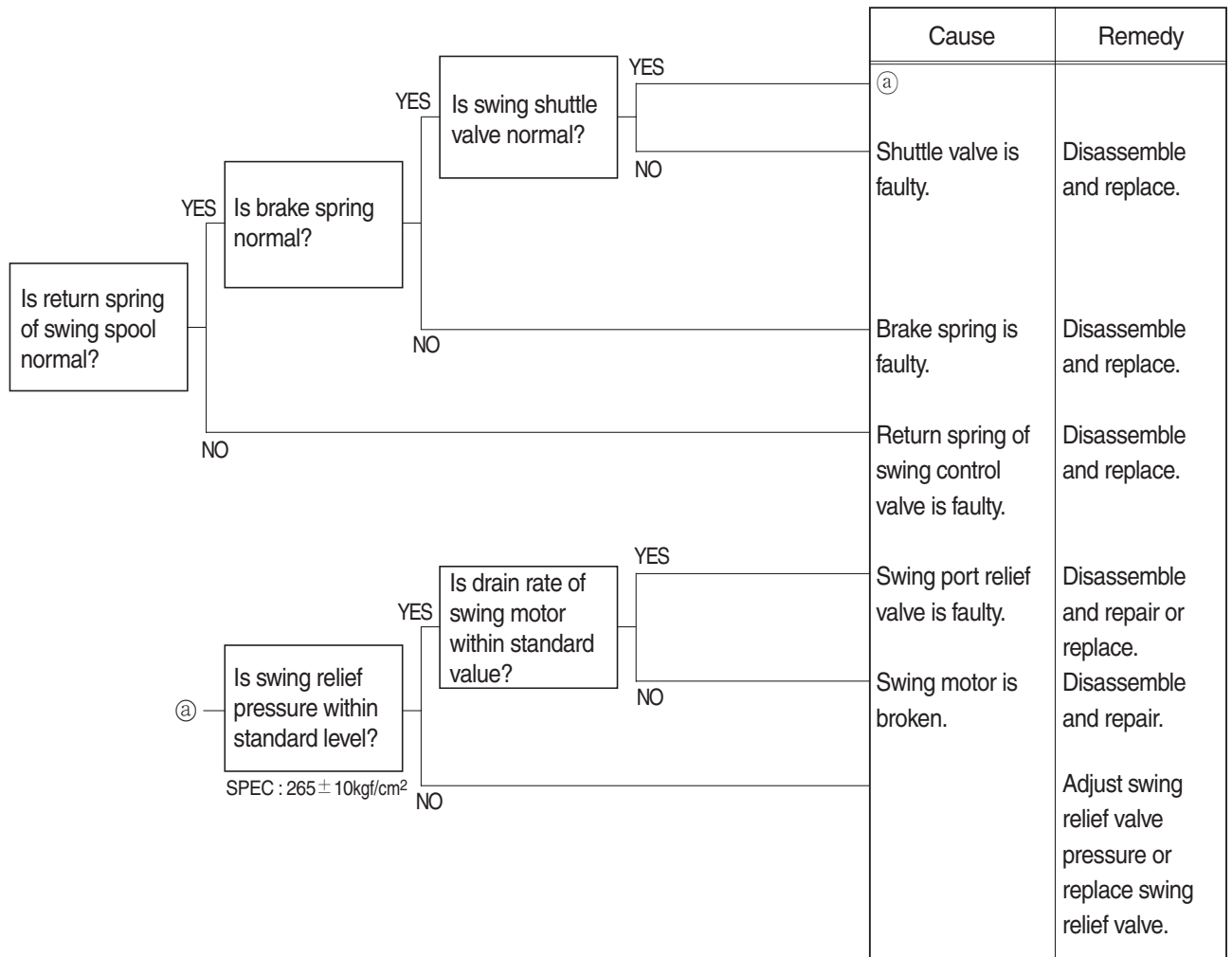

## 5. TRAVEL SYSTEM

### 1) TRAVEL DOES NOT FUNCTION AT ALL ON ONE SIDE

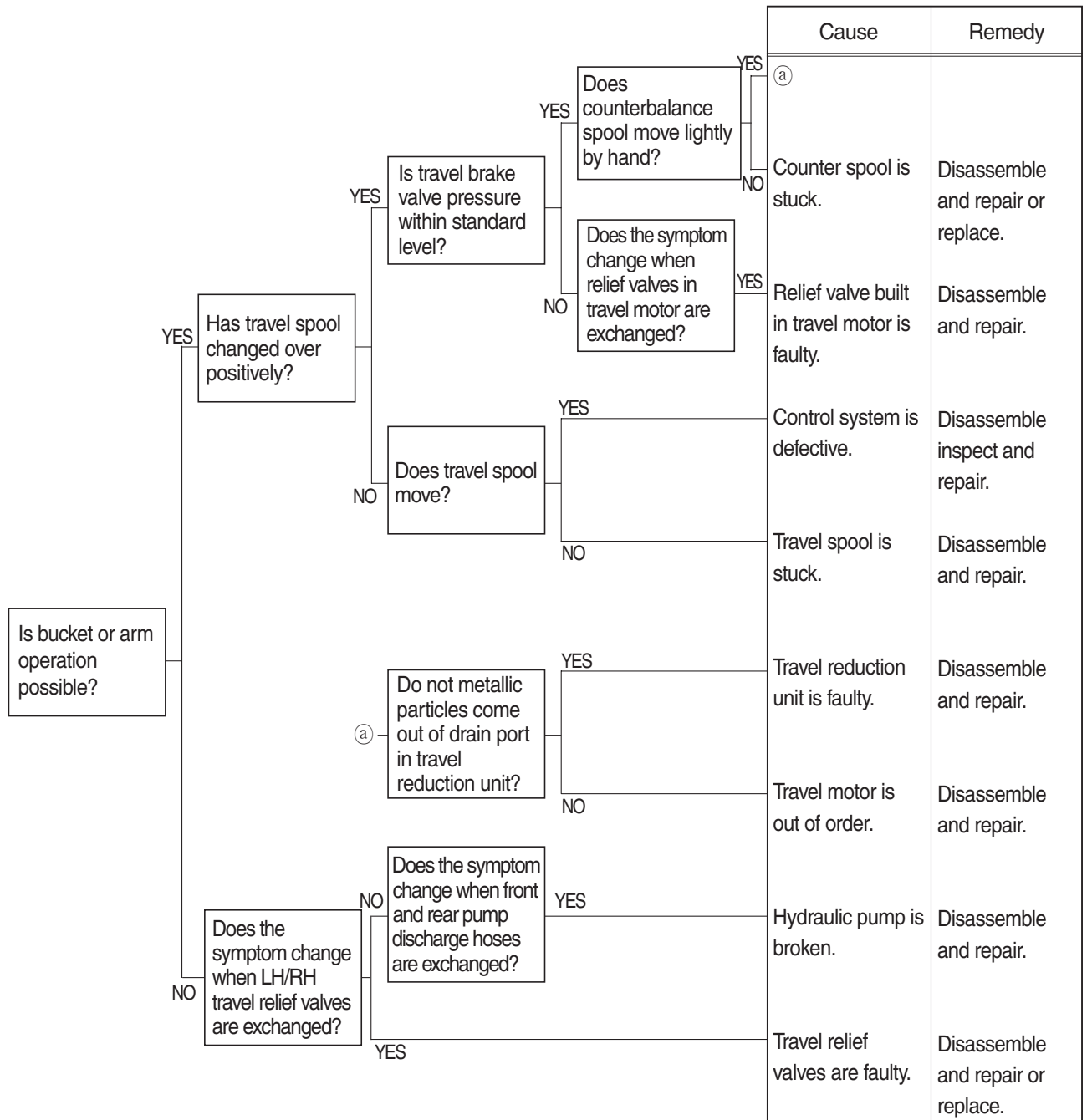

## 2) SPEED ON ONE SIDE FALLS AND THE MACHINE CURVES

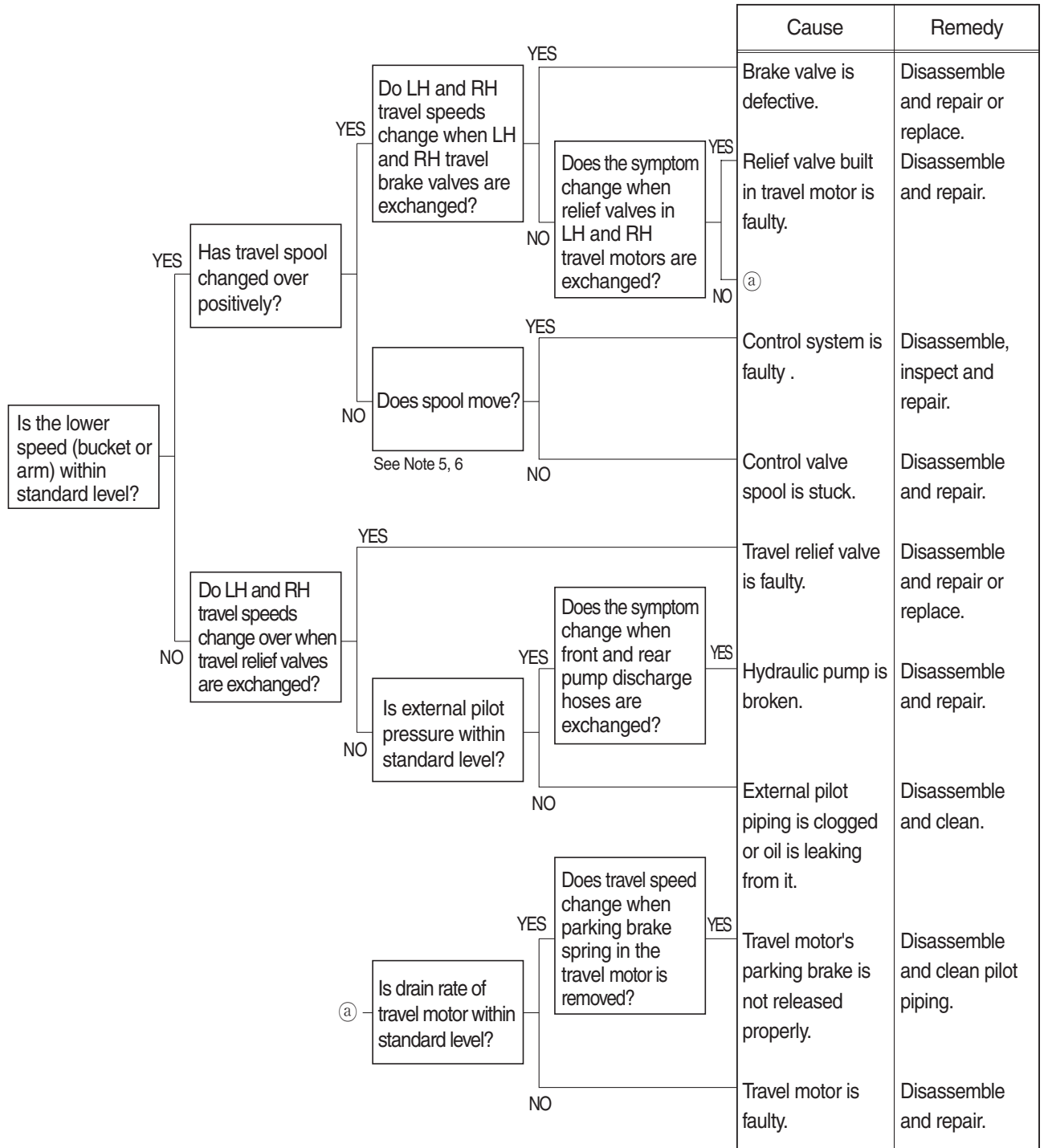

### 3) MACHINE DOES NOT STOP ON A SLOPE

Machine is pulled forward as sprocket rotates during digging operation.

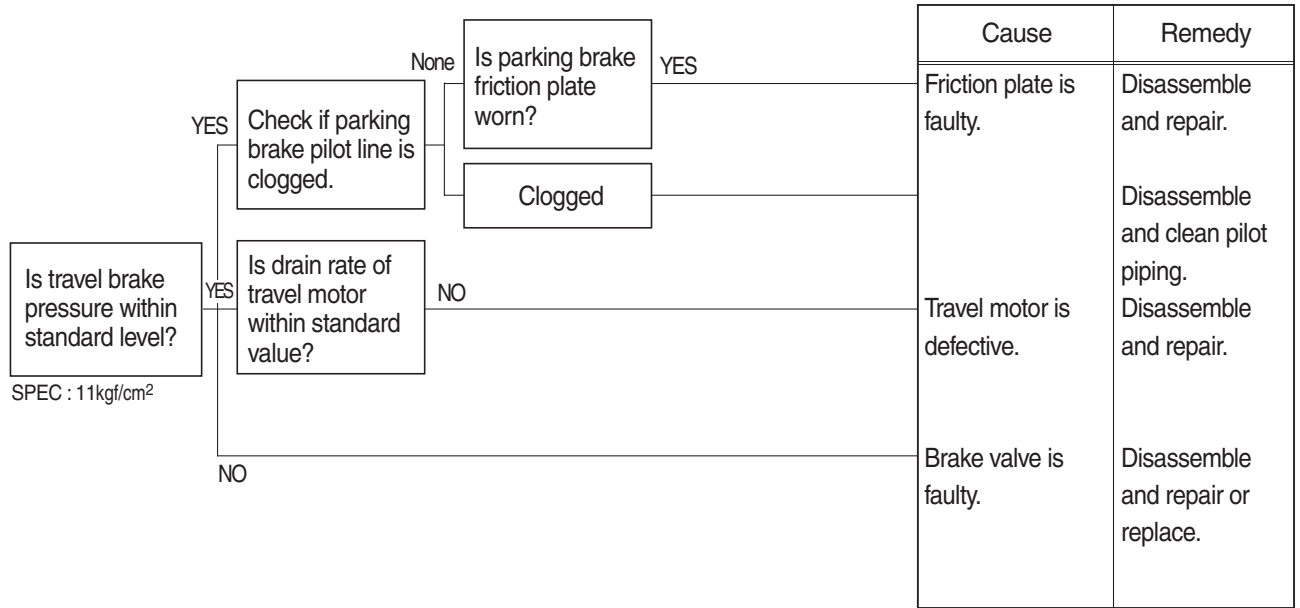

### 4) LH AND RH TRAVEL MOTIONS ARE IMPOSSIBLE

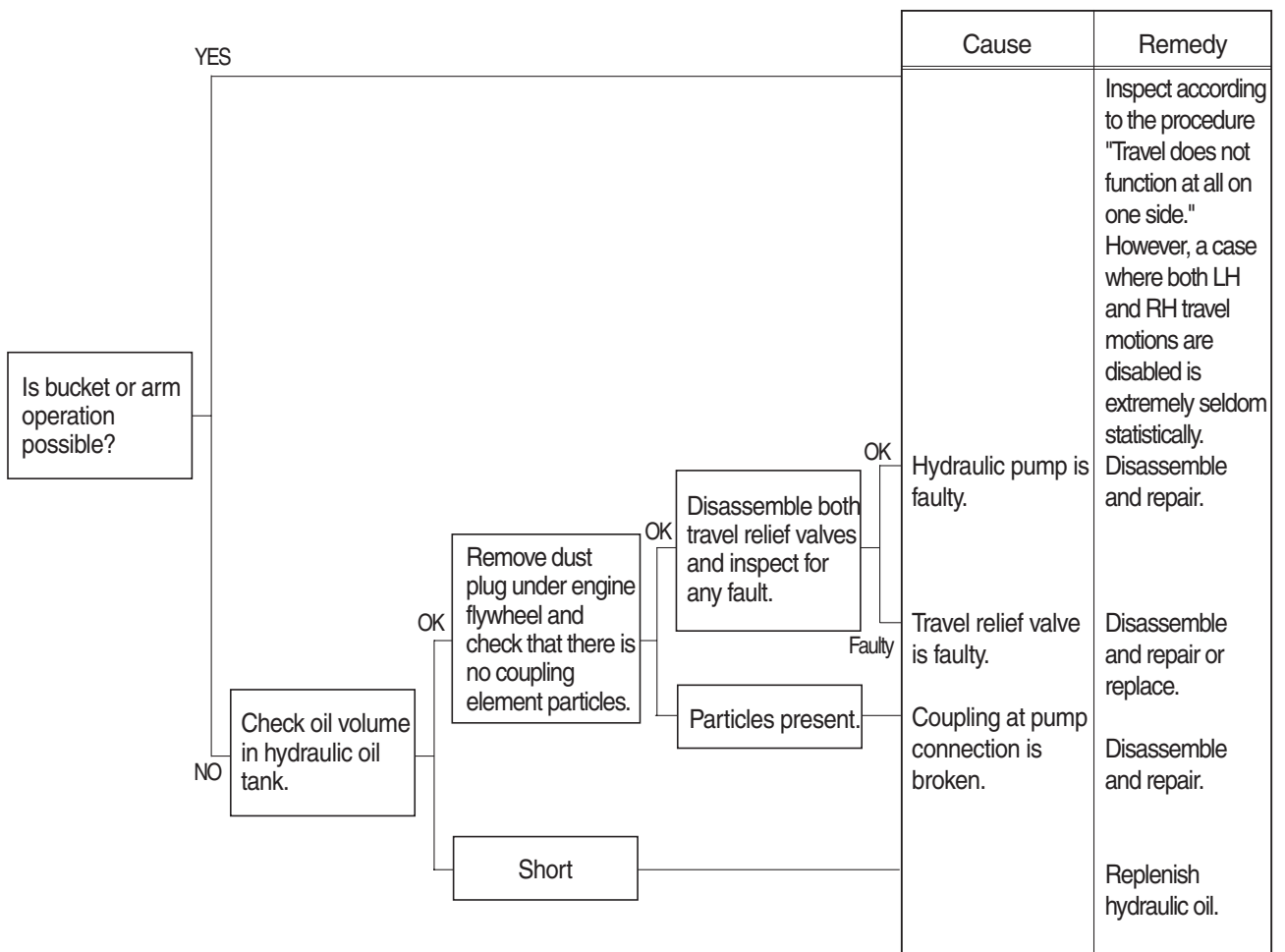

**5) TRAVEL ACTION IS POWERLESS (travel only)**

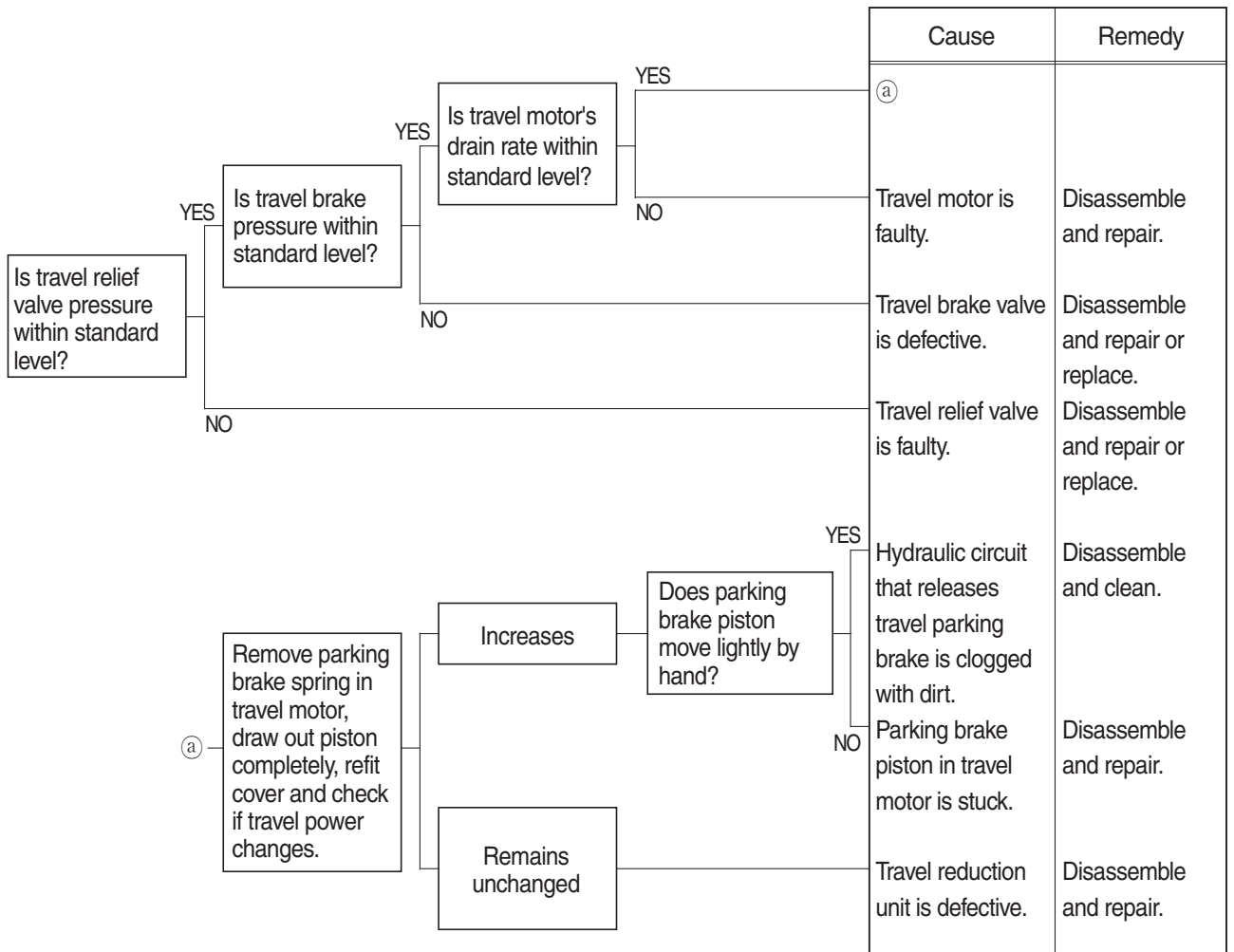

**6) MACHINE RUNS RECKLESSLY ON A SLOPE**



**7) MACHINE MAKES A CURVED TRAVEL OR DOES NOT TRAVEL AT ALL WHEN TRAVEL AND ATTACHMENT OPERATIONS ARE EXECUTED AT THE SAME TIME**

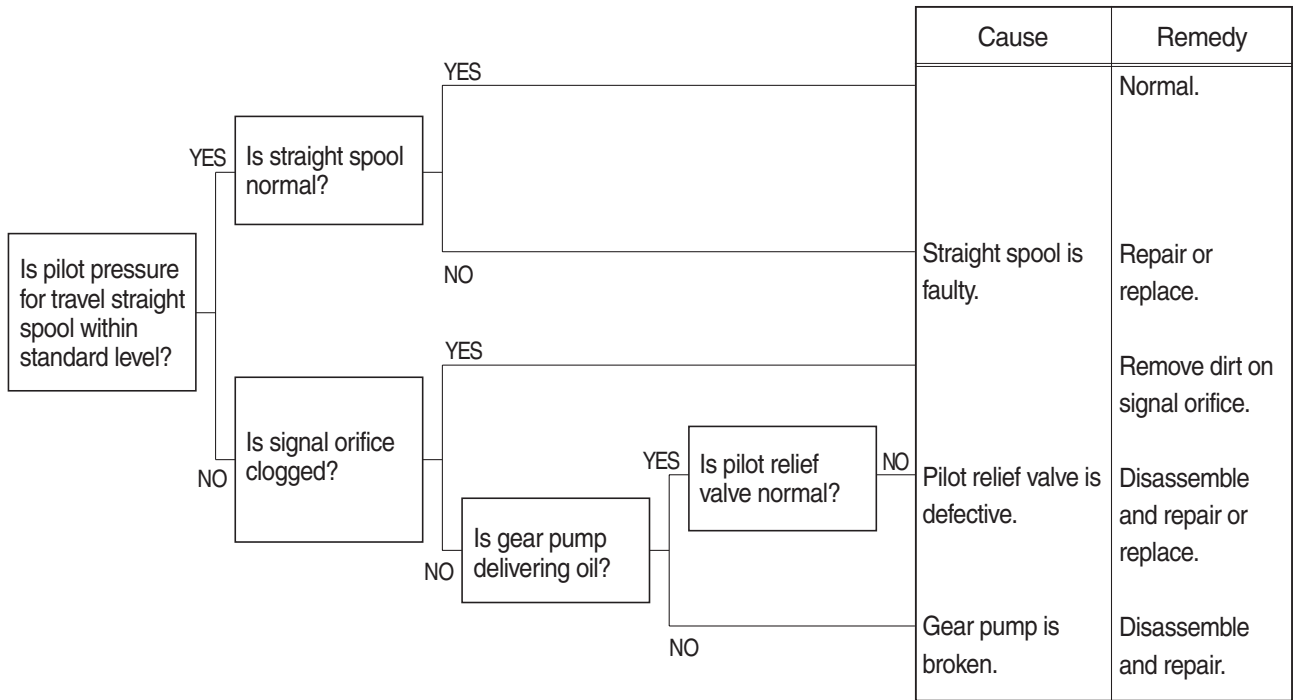

## 6. ATTACHMENT SYSTEM

### 1) BOOM OR ARM ACTION IS IMPOSSIBLE AT ALL

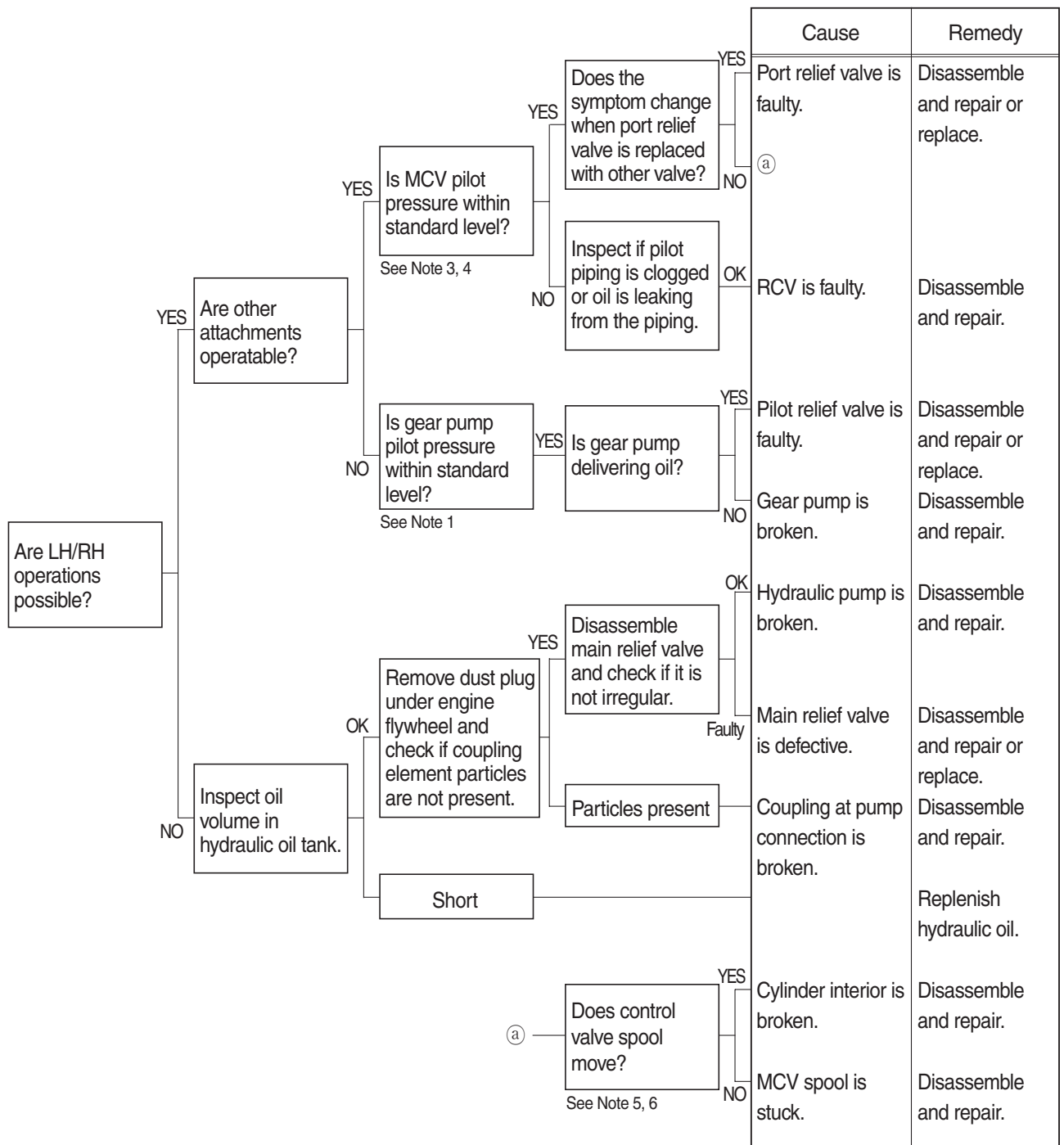

## 2) BOOM, ARM OR BUCKET SPEED IS LOW

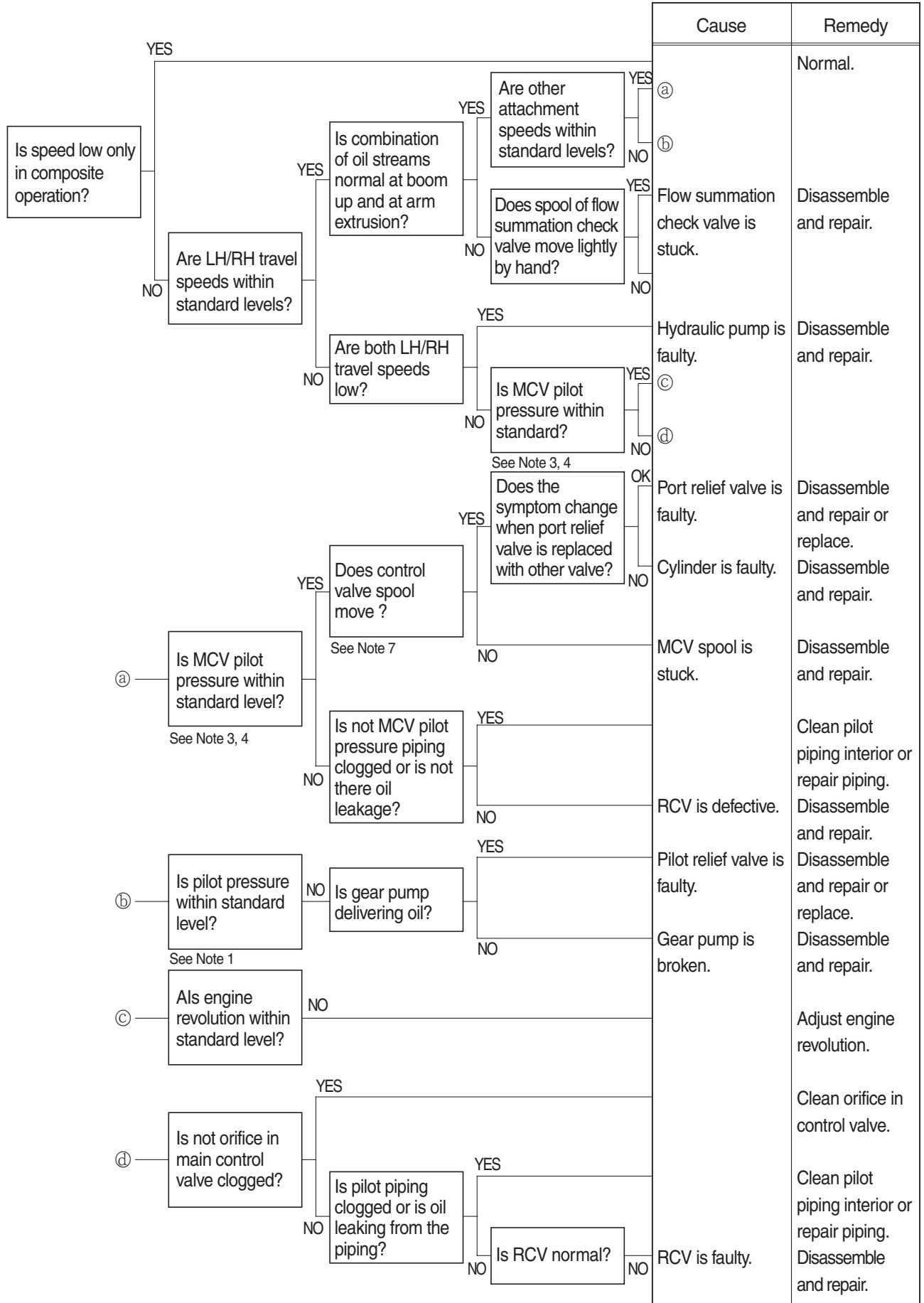



### 3) BOOM, ARM OR BUCKET CYLINDER EXTENDS OR CONTRACTS ITSELF AND ATTACHMENT FALLS

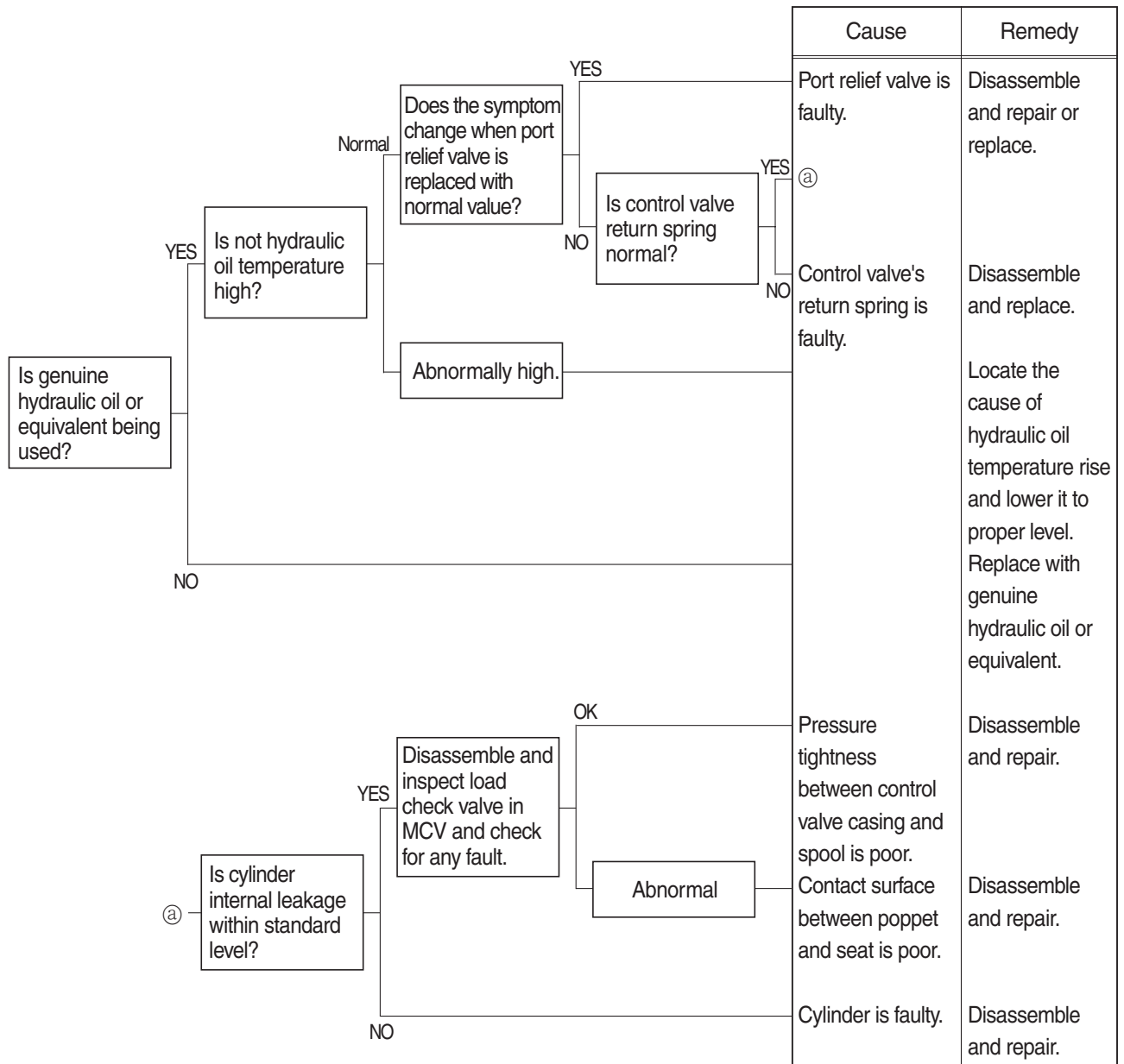

#### 4) BOOM, ARM OR BUCKET POWER IS WEAK

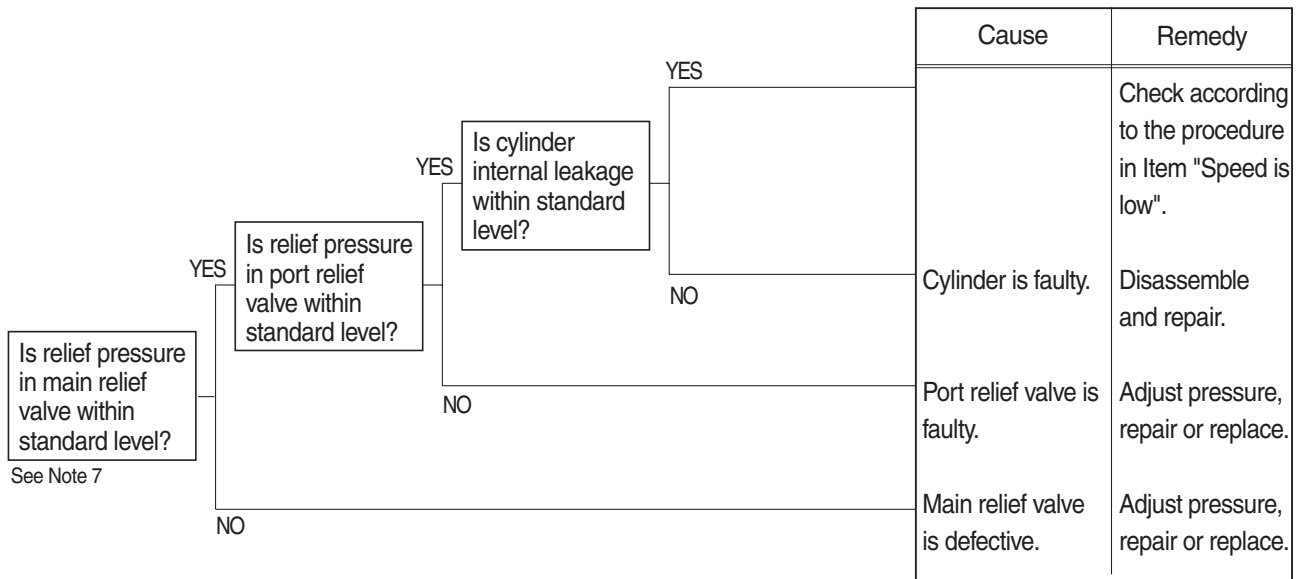

#### 5) ONLY BUCKET OPERATION IS TOTALLY IMPOSSIBLE

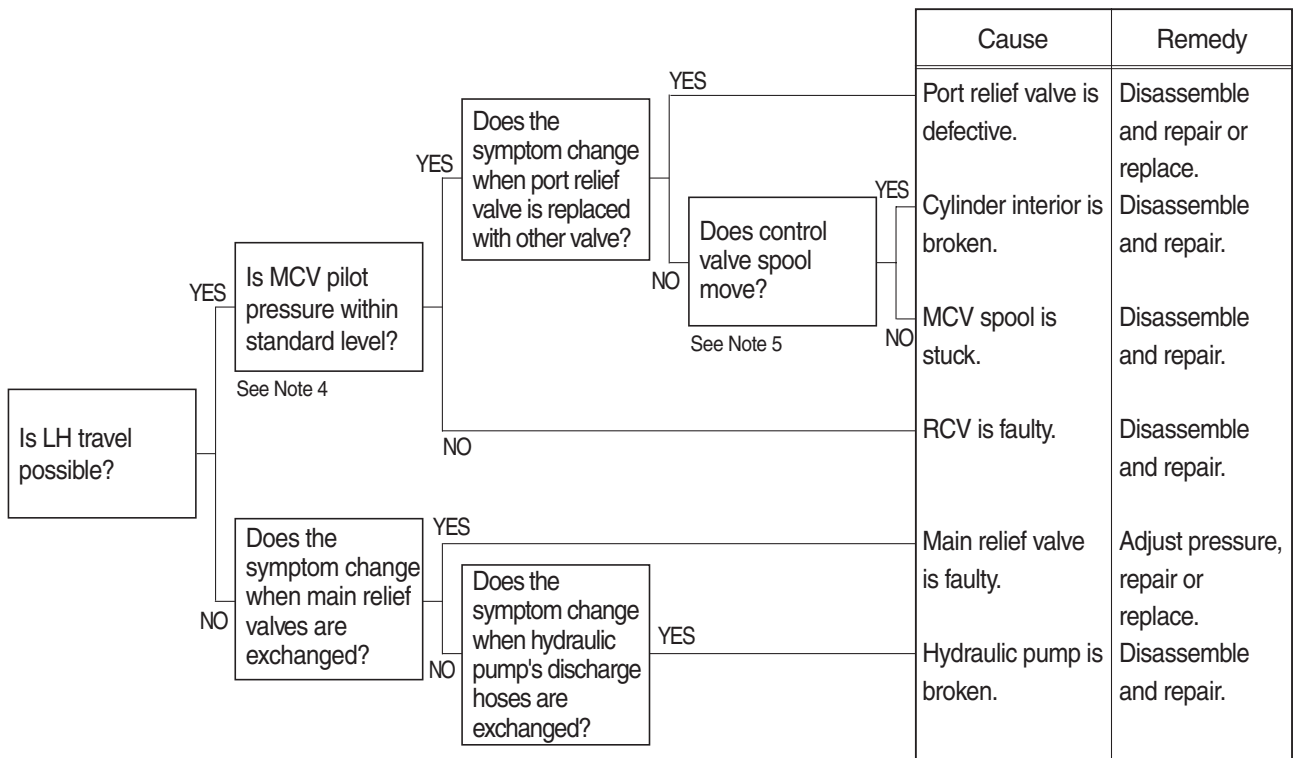

6) BOOM MAKES A SQUEAKING NOISE WHEN BOOM IS OPERATED

		Cause	Remedy
<p>Is boom foot pin greased sufficiently?</p>	<p>YES</p>		<p>Frictional noise occurs between the sliding faces of boom cylinder's oil seal and boom proper.</p> <p>※ Frictional noise will disappear if they are kept used.</p>
	<p>NO</p>	<p>Boom foot pin has run out of grease.</p>	<p>Supply grease to it.</p> <p>※ If seizure is in an initial stage, supply sufficient grease. If seizure is in a grown state, correct it by paper lapping or with an oil stone.</p>

## ※ HOW TO CHECK INTERNAL BOOM CYLINDER LEAKAGE

1. Lower the bucket teeth to the ground with bucket cylinder fully retracted and arm cylinder rod retracted almost in full.

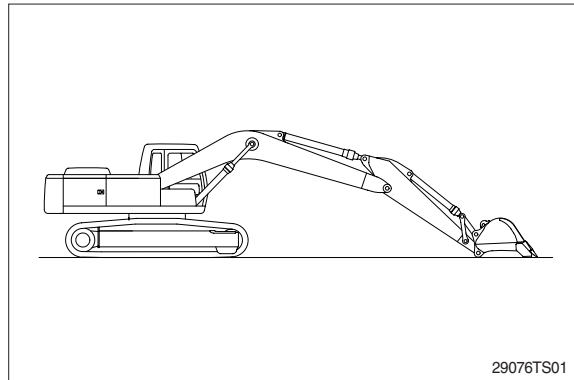

2. Disconnect hose (A) from rod side of boom cylinder and drain oil from cylinders and hose. (put cups on piping and hose ends)

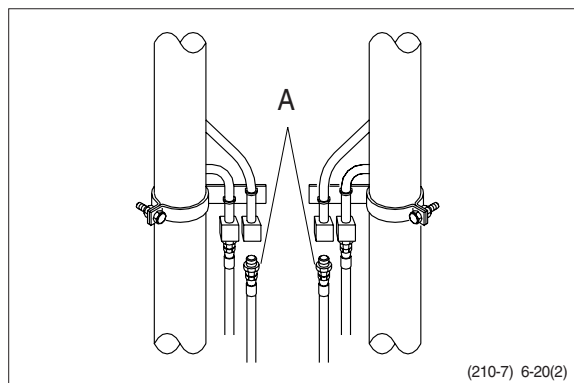

3. Raise bucket OFF the ground by retracting the arm cylinder rod.

If oil leaks from piping side and boom cylinder rod is retracted there is an internal leak in the cylinder.

If no oil leaks from piping side and boom cylinder rod is retracted, there is an internal leak in the control valve.

