

# SECTION 1 GENERAL



Group 1 Safety Hints .....	1-1
Group 2 Specifications .....	1-10

# SECTION 1 GENERAL

## GROUP 1 SAFETY

### FOLLOW SAFE PROCEDURE

Unsafe work practices are dangerous. Understand service procedure before doing work; Do not attempt shortcuts.

### WEAR PROTECTIVE CLOTHING

Wear close fitting clothing and safety equipment appropriate to the job.

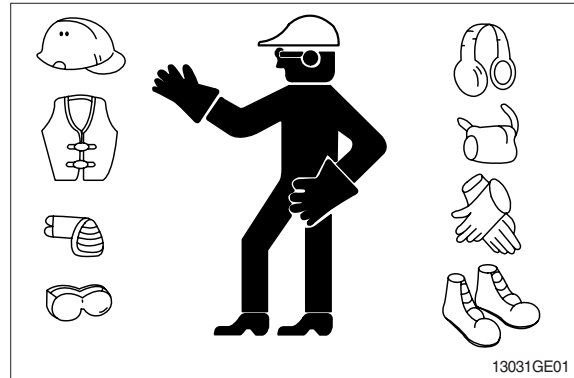

### WARN OTHERS OF SERVICE WORK

Unexpected machine movement can cause serious injury.

Before performing any work on the excavator, attach a 「Do Not Operate」 tag on the right side control lever.

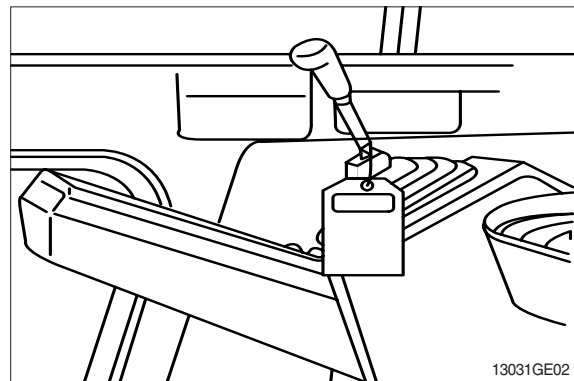

### USE HANDHOLDS AND STEPS

Falling is one of the major causes of personal injury.

When you get on and off the machine, always maintain a three point contact with the steps and handrails and face the machine. Do not use any controls as handholds.

Never jump on or off the machine. Never mount or dismount a moving machine.

Be careful of slippery conditions on platforms, steps, and handrails when leaving the machine.

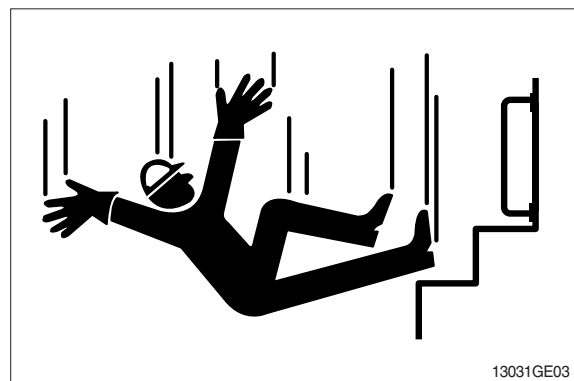

## PREPARE FOR EMERGENCIES

Be prepared if a fire starts.

Keep a first aid kit and fire extinguisher handy.

Keep emergency numbers for doctors, ambulance service, hospital, and fire department near your telephone.

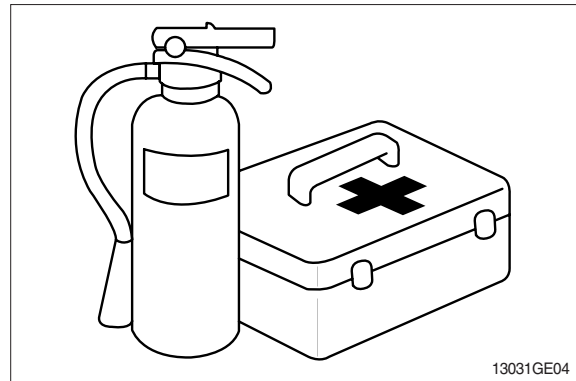

## PROTECT AGAINST FLYING DEBRIS

Guard against injury from flying pieces of metal or debris; Wear goggles or safety glasses.

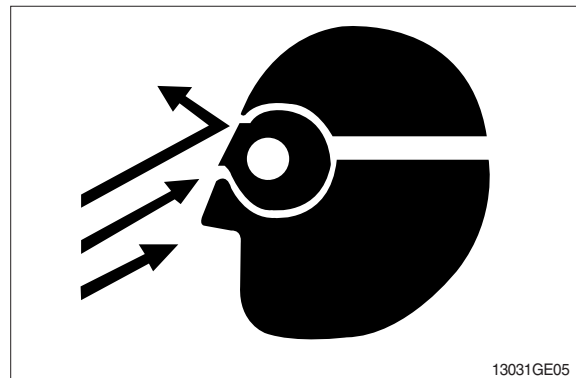

## PROTECT AGAINST NOISE

Prolonged exposure to loud noise can cause impairment or loss of hearing.

Wear a suitable hearing protective device such as earmuffs or earplugs to protect against objectionable or uncomfortable loud noises.

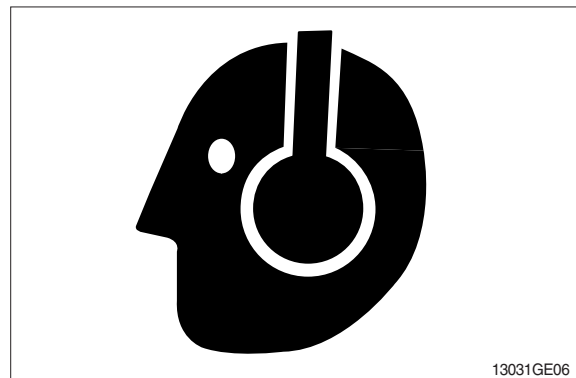

## AVOID POWER LINES

Serious injury or death can result from contact with electric lines.

Never move any part of the machine or load closer to electric line than 3m(10ft) plus twice the line insulator length.

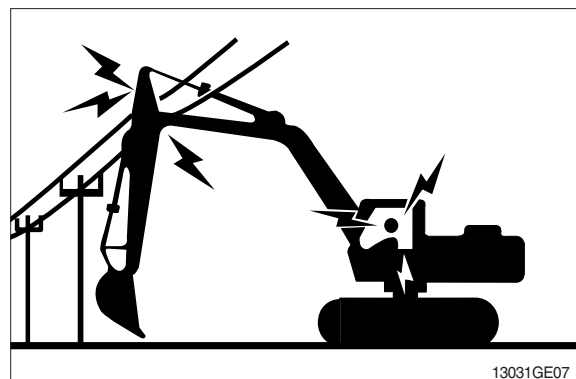

## KEEP RIDERS OFF EXCAVATOR

Only allow the operator on the excavator. Keep riders off.

Riders on excavator are subject to injury such as being struck by foreign objects and being thrown off the excavator. Riders also obstruct the operator's view resulting in the excavator being operated in an unsafe manner.

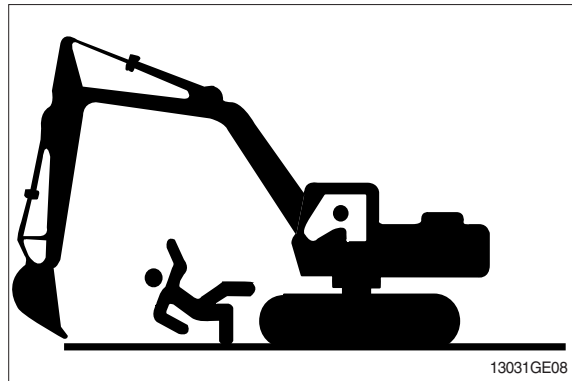

## MOVE AND OPERATE MACHINE SAFELY

Bystanders can be run over. Know the location of bystanders before moving, swinging, or operating the machine.

Always keep the travel alarm in working condition. It warns people when the excavator starts to move.

Use a signal person when moving, swinging, or operating the machine in congested areas. Coordinate hand signals before starting the excavator.

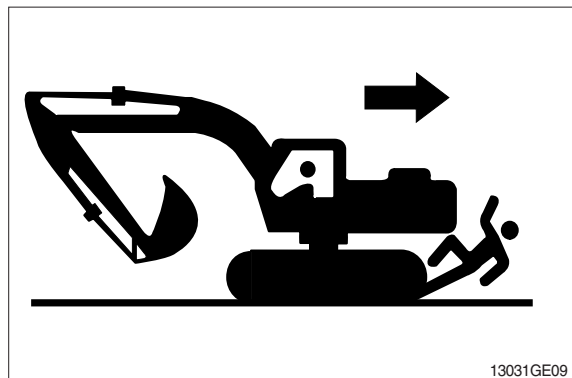

## OPERATE ONLY FROM OPERATOR'S SEAT

Avoid possible injury machine damage. Do not start engine by shorting across starter terminals.

NEVER start engine while standing on ground. Start engine only from operator's seat.



## PARK MACHINE SAFELY

Before working on the machine:

- Park machine on a level surface.
- Lower bucket to the ground.
- Turn auto idle switch off.
- Run engine at 1/2 speed without load for 2 minutes.
- Turn key switch to OFF to stop engine. Remove key from switch.
- Move pilot control shutoff lever to locked position.
- Allow engine to cool.

## SUPPORT MACHINE PROPERLY

Always lower the attachment or implement to the ground before you work on the machine. If you must work on a lifted machine or attachment, securely support the machine or attachment.

Do not support the machine on cinder blocks, hollow tiles, or props that may crumble under continuous load.

Do not work under a machine that is supported solely by a jack. Follow recommended procedures in this manual.

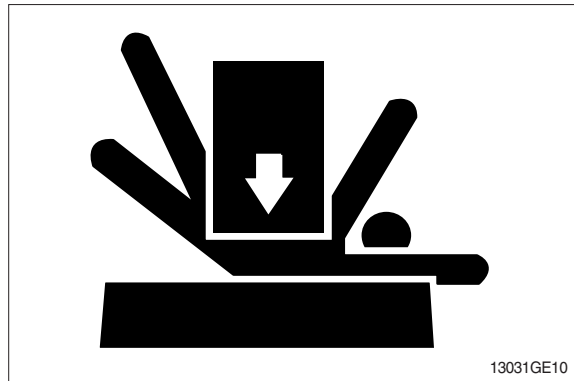

## SERVICE COOLING SYSTEM SAFELY

Explosive release of fluids from pressurized cooling system can cause serious burns.

Shut off engine. Only remove filler cap when cool enough to touch with bare hands.

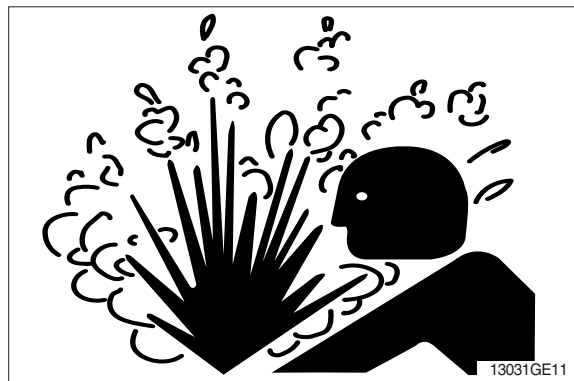

## HANDLE FLUIDS SAFELY-AVOID FIRES

Handle fuel with care; It is highly flammable. Do not refuel the machine while smoking or when near open flame or sparks. Always stop engine before refueling machine. Fill fuel tank outdoors.



Store flammable fluids away from fire hazards. Do not incinerate or puncture pressurized containers.

Make sure machine is clean of trash, grease, and debris.

Do not store oily rags; They can ignite and burn spontaneously.

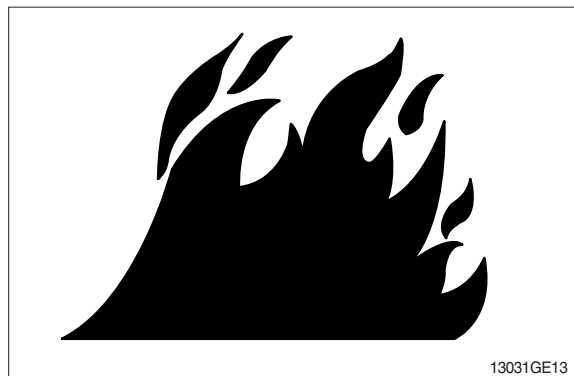

## BEWARE OF EXHAUST FUMES

Prevent asphyxiation. Engine exhaust fumes can cause sickness or death.

If you must operate in a building, be positive there is adequate ventilation. Either use an exhaust pipe extension to remove the exhaust fumes or open doors and windows to bring enough outside air into the area.

## REMOVE PAINT BEFORE WELDING OR HEATING

Avoid potentially toxic fumes and dust.

Hazardous fumes can be generated when paint is heated by welding, soldering, or using a torch.

Do all work outside or in a well ventilated area. Dispose of paint and solvent properly.

Remove paint before welding or heating:

- If you sand or grind paint, avoid breathing the dust.  
Wear an approved respirator.
- If you use solvent or paint stripper, remove stripper with soap and water before welding. Remove solvent or paint stripper containers and other flammable material from area. Allow fumes to disperse at least 15 minutes before welding or heating.

## ILLUMINATE WORK AREA SAFELY

Illuminate your work area adequately but safely. Use a portable safety light for working inside or under the machine. Make sure the bulb is enclosed by a wire cage. The hot filament of an accidentally broken bulb can ignite spilled fuel or oil.

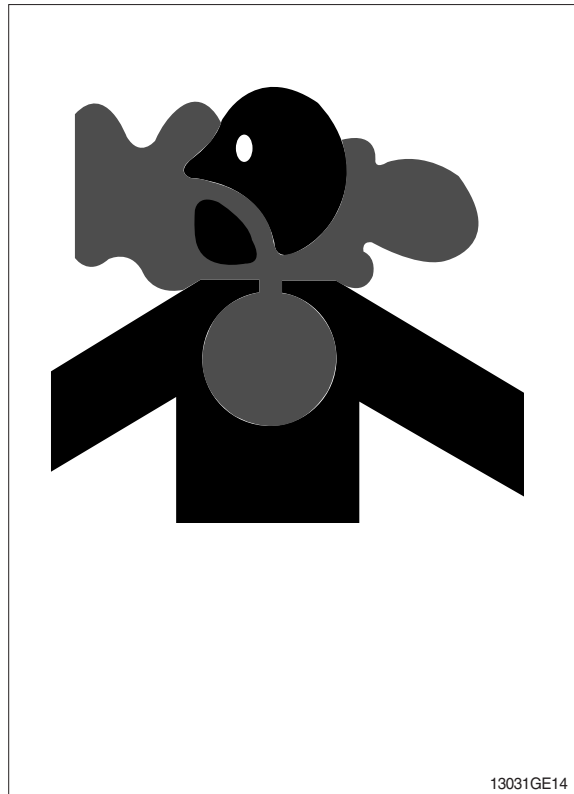

### SERVICE MACHINE SAFELY

Tie long hair behind your head. Do not wear a necktie, scarf, loose clothing or necklace when you work near machine tools or moving parts. If these items were to get caught, severe injury could result.

Remove rings and other jewelry to prevent electrical shorts and entanglement in moving parts.

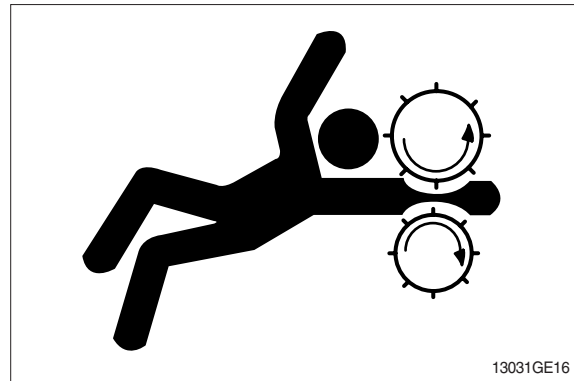

### STAY CLEAR OF MOVING PARTS

Entanglements in moving parts can cause serious injury.

To prevent accidents, use care when working around rotating parts.

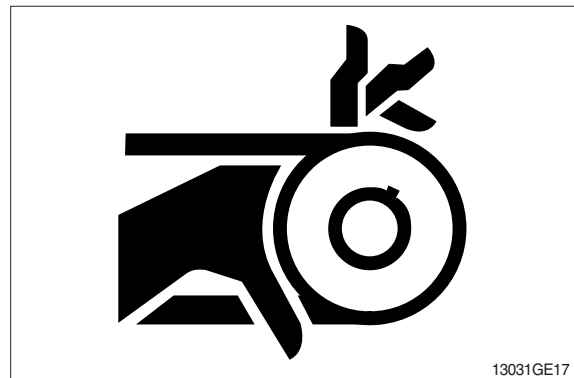

### AVOID HIGH PRESSURE FLUIDS

Escaping fluid under pressure can penetrate the skin causing serious injury.

Avoid the hazard by relieving pressure before disconnecting hydraulic or other lines. Tighten all connections before applying pressure.

Search for leaks with a piece of cardboard. Protect hands and body from high pressure fluids.

If an accident occurs, see a doctor immediately. Any fluid injected into the skin must be surgically removed within a few hours or gangrene may result.

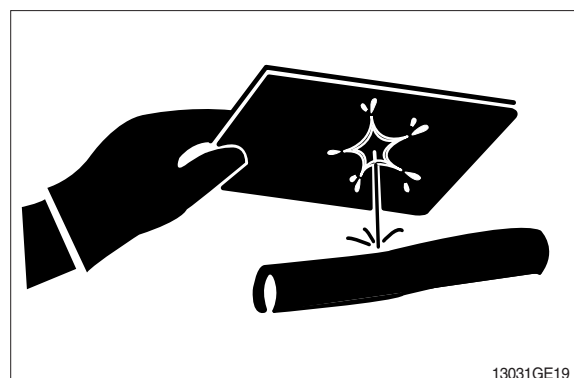

## AVOID HEATING NEAR PRESSURIZED FLUID LINES

Flammable spray can be generated by heating near pressurized fluid lines, resulting in severe burns to yourself and bystanders. Do not heat by welding, soldering, or using a torch near pressurized fluid lines or other flammable materials.

Pressurized lines can be accidentally cut when heat goes beyond the immediate flame area. Install fire resisting guards to protect hoses or other materials.



## PREVENT BATTERY EXPLOSIONS

Keep sparks, lighted matches, and flame away from the top of battery. Battery gas can explode.

Never check battery charge by placing a metal object across the posts. Use a volt-meter or hydrometer.

Do not charge a frozen battery; It may explode. Warm battery to 16°C (60°F).





## PREVENT ACID BURNS

Sulfuric acid in battery electrolyte is poisonous. It is strong enough to burn skin, eat holes in clothing, and cause blindness if splashed into eyes.

Avoid the hazard by:

1. Filling batteries in a well-ventilated area.
2. Wearing eye protection and rubber gloves.
3. Avoiding breathing fumes when electrolyte is added.
4. Avoiding spilling or dripping electrolyte.
5. Use proper jump start procedure.

If you spill acid on yourself:

1. Flush your skin with water.
2. Apply baking soda or lime to help neutralize the acid.
3. Flush your eyes with water for 10-15 minutes. Get medical attention immediately.

If acid is swallowed:

1. Drink large amounts of water or milk.
2. Then drink milk of magnesia, beaten eggs, or vegetable oil.
3. Get medical attention immediately.

## USE TOOLS PROPERLY

Use tools appropriate to the work. Makeshift tools, parts, and procedures can create safety hazards.

Use power tools only to loosen threaded tools and fasteners.

For loosening and tightening hardware, use the correct size tools. **DO NOT** use U.S. measurement tools on metric fasteners. Avoid bodily injury caused by slipping wrenches.

Use only recommended replacement parts. (See Parts catalogue.)

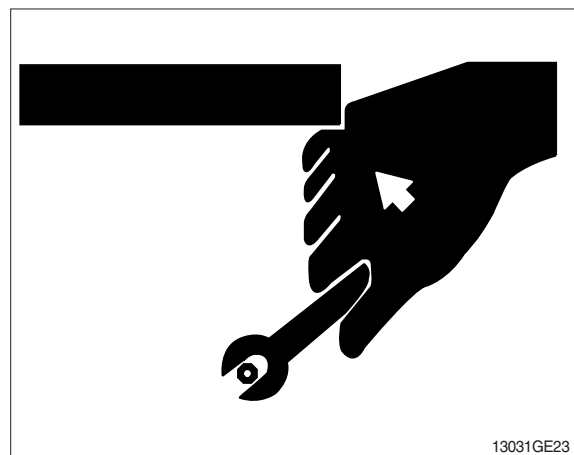
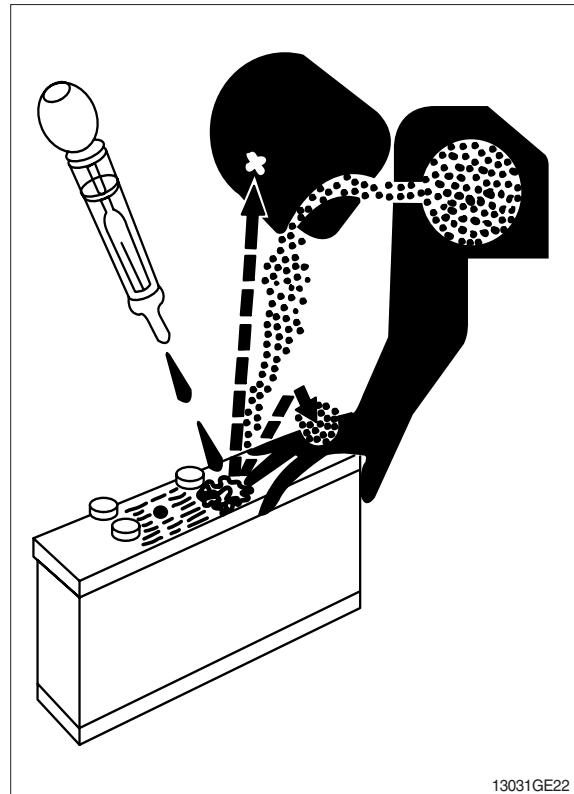

## DISPOSE OF FLUIDS PROPERLY

Improperly disposing of fluids can harm the environment and ecology. Before draining any fluids, find out the proper way to dispose of waste from your local environmental agency.

Use proper containers when draining fluids. Do not use food or beverage containers that may mislead someone into drinking from them.

DO NOT pour oil into the ground, down a drain, or into a stream, pond, or lake. Observe relevant environmental protection regulations when disposing of oil, fuel, coolant, brake fluid, filters, batteries, and other harmful waste.

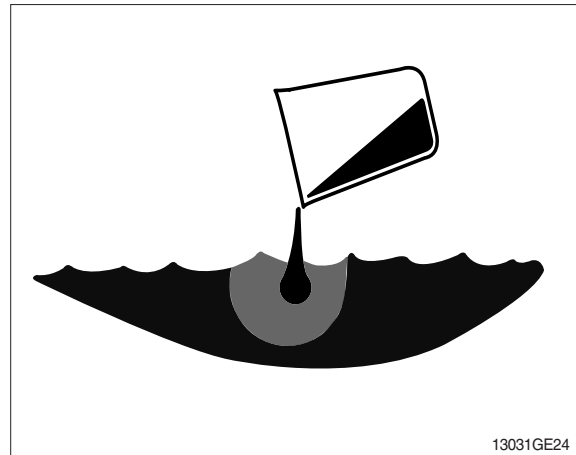

## REPLACE SAFETY SIGNS

Replace missing or damaged safety signs. See the machine operator's manual for correct safety sign placement.

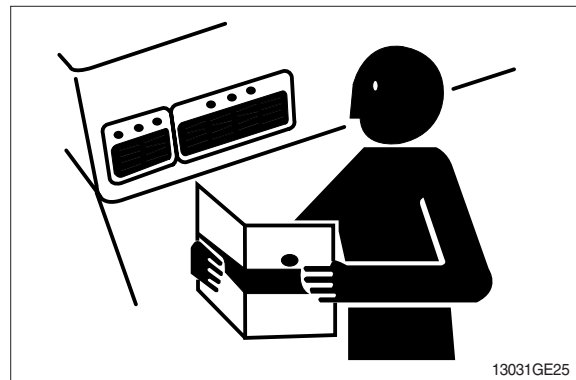

## LIVE WITH SAFETY

Before returning machine to customer, make sure machine is functioning properly, especially the safety systems. Install all guards and shields.

# GROUP 2 SPECIFICATIONS

## 1. MAJOR COMPONENT

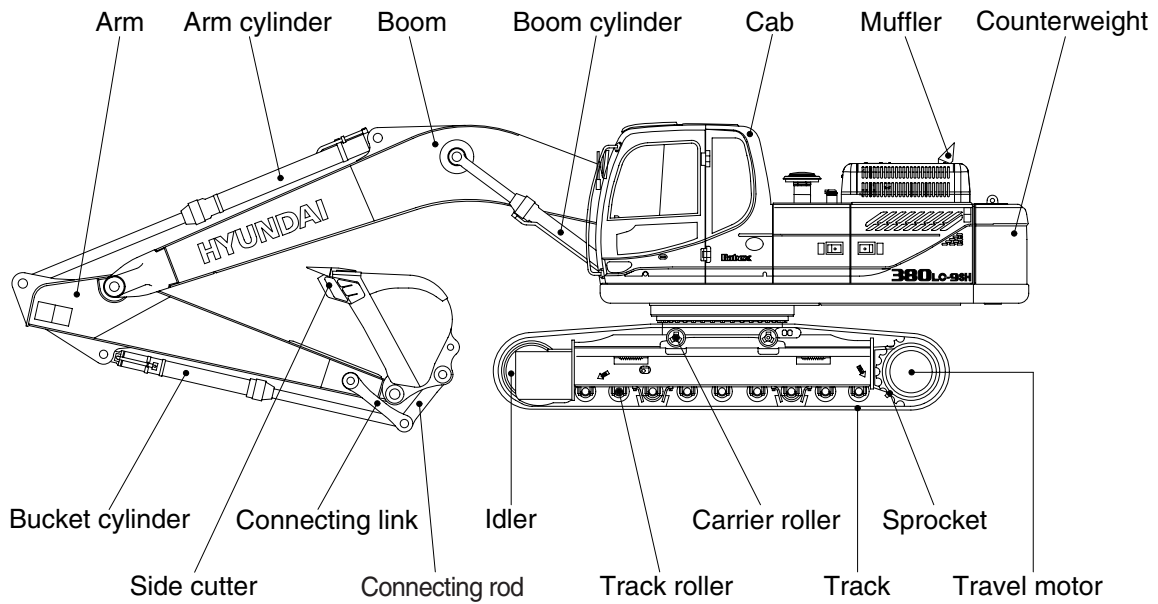
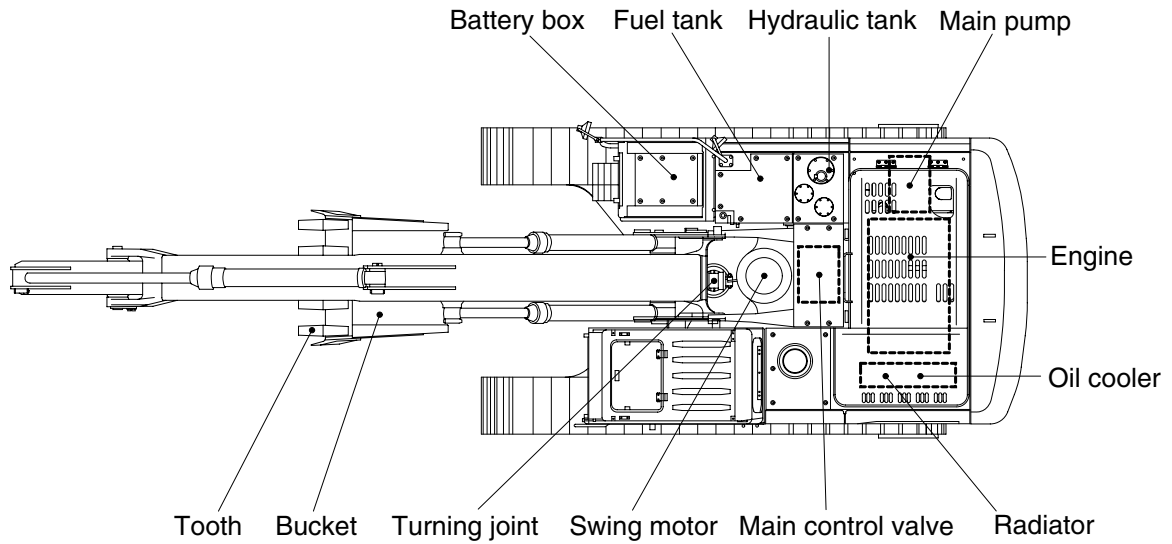

3809SH2SP01

## 2. SPECIFICATIONS

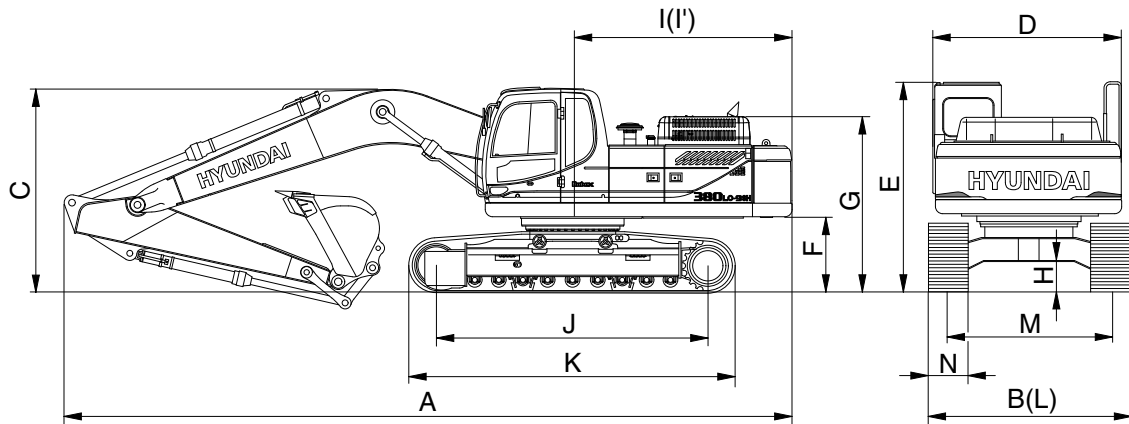

3809SH2SP02

Description		Unit	Specification
Operating weight		kg (lb)	38450 (84770)
Bucket capacity (SAE heaped), standard		m <sup>3</sup> (yd <sup>3</sup> )	1.62 (2.12)
Overall length	A	mm (ft-in)	11120 (36' 6")
Overall width, with 600 mm shoe	B		3340 (10'11")
Overall height	C		3450 (11' 4")
Superstructure width	D		2980 ( 9' 9")
Overall height of cab	E		3175 (10' 5")
Ground clearance of counterweight	F		1290 ( 4' 3")
Engine cover height	G		2790 ( 9' 2")
Minimum ground clearance	H		550 ( 1' 10")
Rear-end distance	I		3350 (11' 1")
Rear-end swing radius	I'		3415 (11' 2")
Distance between tumblers	J		4340 (14' 3")
Undercarriage length	K		5280 (17' 4")
Undercarriage width	L		3340 (11' 0")
Track gauge	M		2740 ( 9' 0")
Track shoe width, standard	N		600 (24")
Travel speed (low/high)		km/hr (mph)	3.1/5.0 (1.9/3.1)
Swing speed		rpm	9.7
Gradeability		Degree (%)	35 (70)
Ground pressure (600 mm shoe)		kgf/cm <sup>2</sup> (psi)	0.69 (9.81)
Max traction force		kg (lb)	32000 (70550)

### 3. WORKING RANGE

· 6.5 m (21' 4") BOOM

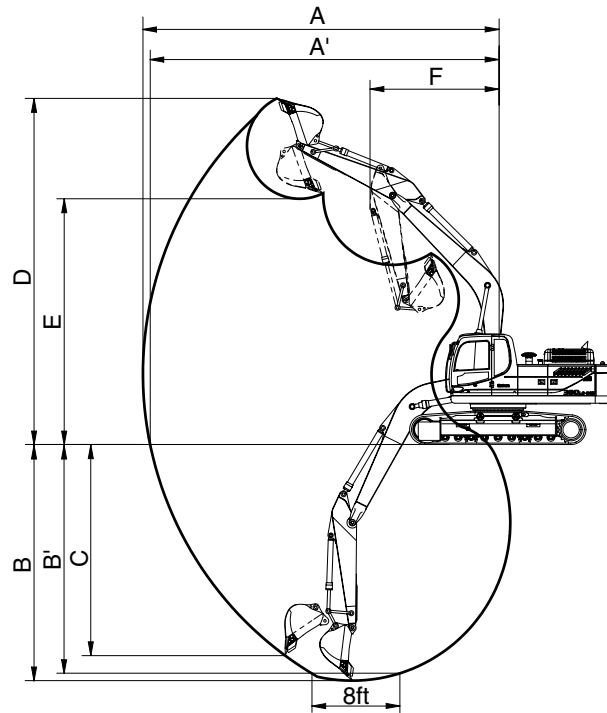

3809SH2SP03

Description		2.5 m (8' 2") Arm	*3.2 m (10' 6") Arm	3.9 m (12' 10") Arm	4.3 m (14' 1") Arm
Max digging reach	A	10720 mm (35' 2")	11250 mm (36'11")	11870 mm (38'11")	12380 mm (40' 7")
Max digging reach on ground	A'	10490 mm (34' 5")	11040 mm (36' 3")	11670 mm (38' 3")	12180 mm (40' 0")
Max digging depth	B	6820 mm (22' 5")	7520 mm (24' 8")	8220 mm (27' 0")	8620 mm (28' 3")
Max digging depth (8ft level)	B'	6640 mm (21' 9")	7360 mm (24' 2")	8080 mm (26' 6")	8490 mm (27'10")
Max vertical wall digging depth	C	5930 mm (19' 5")	6330 mm (20' 9")	7040 mm (23' 1")	7540 mm (24' 9")
Max digging height	D	10590 mm (34' 9")	10570 mm (34' 8")	10800 mm (35' 5")	11360 mm (37' 3")
Max dumping height	E	7370 mm (24' 2")	7410 mm (24' 4")	7640 mm (25' 1")	8160 mm (26' 9")
Min swing radius	F	4530 mm (14'10")	4450 mm (14' 7")	4440 mm (14' 7")	4460 mm (14' 8")
Bucket digging force	SAE	201.0 [219.3] kN	201.0 [219.3] kN	201.0 [219.3] kN	201.0 [219.3] kN
		20500 [22360] kgf	20500 [22360] kgf	20500 [22360] kgf	20500 [22360] kgf
		45190 [49300] lbf	45190 [49300] lbf	45190 [49300] lbf	45190 [49300] lbf
	ISO	228.5 [249.3] kN	228.5 [249.3] kN	228.5 [249.3] kN	228.5 [249.3] kN
		23300 [25420] kgf	23300 [25420] kgf	23300 [25420] kgf	23300 [25420] kgf
		51370 [56040] lbf	51370 [56040] lbf	51370 [56040] lbf	51370 [56040] lbf
Arm crowd force	SAE	184.4 [201.1] kN	152.0 [165.8] kN	135.3 [147.6] kN	124.5 [135.9] kN
		18800 [20510] kgf	15500 [16910] kgf	13800 [15050] kgf	12700 [13850] kgf
		41450 [45220] lbf	34170 [37280] lbf	30420 [33190] lbf	28000 [30550] lbf
	ISO	192.2 [209.7] kN	156.9 [171.2] kN	139.3 [151.9] kN	128.5 [140.1] kN
		19600 [21380] kgf	16000 [17450] kgf	14200 [15490] kgf	13100 [14290] kgf
		43210 [47140] lbf	35270 [38480] lbf	31310 [34160] lbf	28880 [31510] lbf

[ ] : Power boost      \* : STD

· 6.15 m (20' 2") BOOM

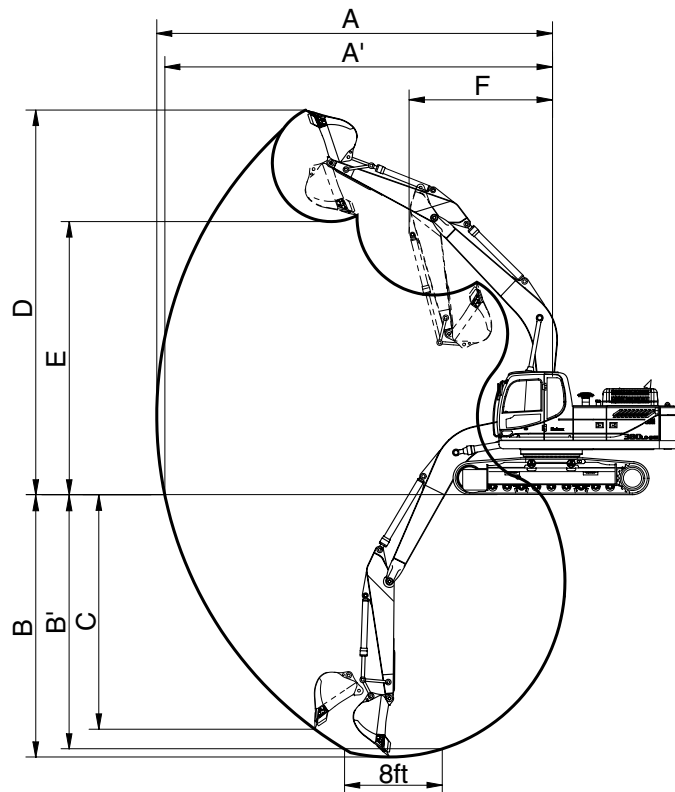

3809SH2SP03

Description		2.5 m (8' 2") Arm	
Max digging reach	A	10330 mm (33'11")	
Max digging reach on ground	A'	10100 mm (33' 2")	
Max digging depth	B	6450 mm (21' 2")	
Max digging depth (8ft level)	B'	6270 mm (20' 7")	
Max vertical wall digging depth	C	5490 mm (18' 0")	
Max digging height	D	10320 mm (33'10")	
Max dumping height	E	7120 mm (23' 4")	
Min swing radius	F	4220 mm (13'10")	
Bucket digging force	SAE	201.0 [219.3] kN	
		20500 [22360] kgf	
		45190 [49300] lbf	
	ISO	228.5 [249.3] kN	
		23300 [25420] kgf	
		51370 [56040] lbf	
Arm crowd force	SAE	184.4 [201.1] kN	
		18800 [20510] kgf	
		41450 [45220] lbf	
	ISO	192.2 [209.7] kN	
		19600 [21380] kgf	
		43210 [47140] lbf	

[ ] : Power boost

· 8.6 m (28' 3") BOOM

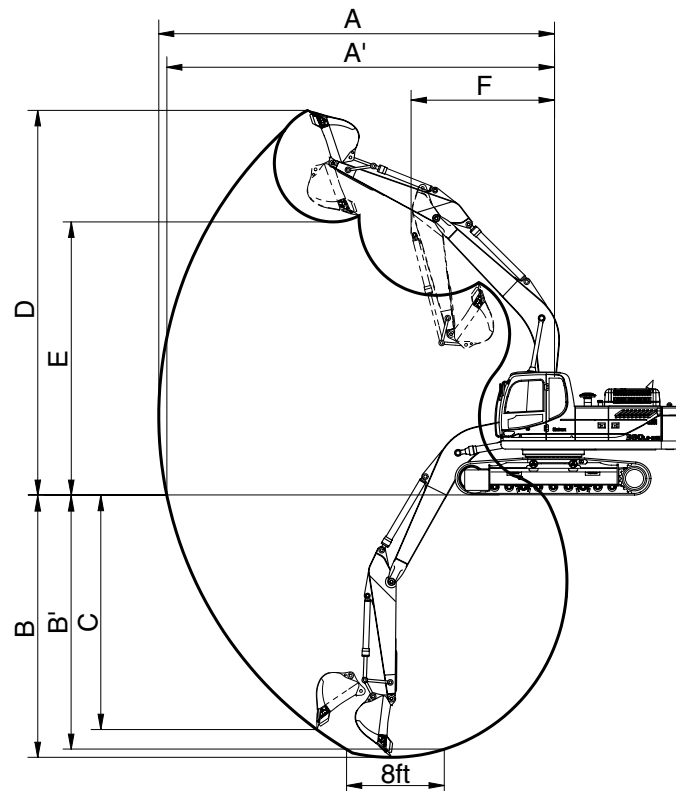

3809SH2SP03

Description		5.1 m (16' 9") Arm
Max digging reach	A	15280 mm (50' 2")
Max digging reach on ground	A'	15120 mm (49' 7")
Max digging depth	B	11230 mm (36' 10")
Max digging depth (8ft level)	B'	11120 mm (36' 6")
Max vertical wall digging depth	C	10060 mm (33' 0")
Max digging height	D	13350 mm (43' 10")
Max dumping height	E	10150 mm (33' 4")
Min swing radius	F	5900 mm (19' 4")
Bucket digging force	SAE	201.0 [220.4] kN
		20500 [22360] kgf
		45190 [49550] lbf
	ISO	228.5 [250.3] kN
		23300 [25420] kgf
		51370 [56280] lbf
Arm crowd force	SAE	109.8 [119.8] kN
		11200 [12220] kgf
		24690 [26930] lbf
	ISO	112.8 [123.0] kN
		11500 [12550] kgf
		25350 [27650] lbf

[ ] : Power boost

#### 4. WEIGHT















Item	R380LC-9SH		
	kg	lb	
Upperstructure assembly	15040	33160	
Main frame weld assembly	3090	6810	
Engine assembly	920	2030	
Main pump assembly	190	420	
Main control valve assembly	340	750	
Swing motor assembly	440	970	
Hydraulic oil tank assembly	340	750	
Fuel tank assembly	230	510	
Counterweight	6.5, 6.15 m boom	6500	14330
	8.6 m boom	8100	17860
Cab assembly	490	1080	
Lower chassis assembly	14310	31550	
Track frame weld assembly	5415	11940	
Swing bearing	560	1240	
Travel motor assembly	380	840	
Turning joint	65	140	
Track recoil spring	210	460	
Idler	260	570	
Carrier roller	41	90	
Track roller	80	180	
Track-chain assembly (600 mm standard triple grouser shoe)	2380	5250	
Front attachment assembly (6.5 m boom, 3.2 m arm, 1.62 m <sup>3</sup> SAE heaped bucket)	7720	17020	
6.5 m boom assembly	2930	6460	
3.2 m arm assembly	1340	2950	
1.62 m <sup>3</sup> SAE heaped bucket	1330	2930	
Boom cylinder assembly	370	820	
Arm cylinder assembly	490	1080	
Bucket cylinder assembly	320	710	
Bucket control linkage assembly	370	820	



## 5. LIFTING CAPACITIES











1) 6.5 m (21' 4") boom, 3.2 m (10' 6") arm equipped with 1.62 m<sup>3</sup> (SAE heaped) bucket and 600 mm (24") triple grouser shoe and 6500 kg (14330 lb counterweight).

-  : Rating over-front
-  : Rating over-side or 360 degree











Load point height	Load radius												At max. reach						
	1.5 m (5.0 ft)		3.0 m (10.0 ft)		4.5 m (15.0 ft)		6.0 m (20.0 ft)		7.5 m (25.0 ft)		9.0 m (30.0 ft)		Capacity	Reach					
															m (ft)				
9.0 m (30 ft)	kg																*5950	*5950	7.97
	lb																*13120	*13120	(26.1)
7.5 m (25.0 ft)	kg								*4560	*4560							*6020	4890	9.12
	lb								*10050	*10050							*13270	10780	(29.9)
6.0 m (20.0 ft)	kg								*6620	*6620							*6110	4070	9.87
	lb								*14590	*14590							*13470	8970	(32.4)
4.5 m (15.0 ft)	kg							*8260	*8260	*7320	6610	*4450	*4450	*6190	3600	10.32			
	lb							*18210	*18210	*16140	14570	*9810	*9810	*13650	7940	(33.9)			
3.0 m (10.0 ft)	kg				*13520	*13520	*9960	9020	*8240	6240	*6360	4490	6010	3360	10.50				
	lb				*29810	*29810	*21960	19890	*18170	13760	*14020	9900	13250	7410	(34.4)				
1.5 m (5.0 ft)	kg				*16390	13030	*11570	8370	*9170	5880	*7510	4300	5960	3310	10.45				
	lb				*36130	28730	*25510	18450	*20220	12960	*16560	9480	13140	7300	(34.3)				
Ground Line	kg			*13090	*13090	*17880	12390	*12690	7930	*9880	5600	*7070	4150	6200	10.14				
	lb			*28860	*28860	*39420	27320	*27980	17480	*21780	12350	*15590	9150	13670	(33.3)				
-1.5 m (-5.0 ft)	kg	*13720	*13720	*17520	*17520	*18150	12180	*13170	7710	9860	5450			6810	3800	9.57			
	lb	*30250	*30250	*38620	*38620	*40010	26850	*29030	17000	21740	12020			15010	8380	(31.4)			
-3.0 m (-10.0 ft)	kg	*17880	*17880	*22800	*22800	*17430	12250	*12880	7690	9860	5450			*7730	4560	8.65			
	lb	*39420	*39420	*50270	*50270	*38430	27010	*28400	16950	21740	12020			*17040	10050	(28.4)			
-4.5 m (-15.0 ft)	kg	*22600	*22600	*21880	*21880	*15520	12550	*11510	7890					*7690	6290	7.25			
	lb	*49820	*49820	*48240	*48240	*34220	27670	*25380	17390					*16950	13870	(23.8)			
-6.0 m (-20.0 ft)	kg					*11410	*11410												
	lb					*25150	*25150												

- Note
1. Lifting capacity are based on SAE J1097 and ISO 10567.
  2. Lifting capacity of the ROBEX series does not exceed 75% of tipping load with the machine on firm, level ground or 87% of full hydraulic capacity.
  3. The load point is a hook located on the back of the bucket.
  4. \*indicates load limited by hydraulic capacity.

















(2) 6.15 m (20' 2") boom, 2.5 m (8' 2") arm equipped with 1.62 m<sup>3</sup> (SAE heaped) bucket and 600 mm (24") triple grouser shoe and 6500 kg (14330 lb) counterweight.

Load point height		Load radius								At max. reach		
		3.0 m (10.0 ft)		4.5 m (15.0 ft)		6.0 m (20.0 ft)		7.5 m (25.0 ft)		Capacity		Reach
												m (ft)
9.0 m (30.0 ft)	kg									*7580	*7580	6.65
	lb									*16710	*16710	(21.8)
7.5 m (25.0 ft)	kg									*7420	6270	8.02
	lb									*16360	13820	(26.3)
6.0 m (20.0 ft)	kg					*8590	*8590	*6510	*6510	*7460	5050	8.88
	lb					*18940	*18940	*14350	*14350	*16450	11130	(29.1)
4.5 m (15.0 ft)	kg	*18270	*18270	*12170	*12170	*9790	*9790	*8620	6640	7560	4410	9.38
	lb	*40280	*40280	*26830	*26830	*21580	*21580	*19000	14640	16670	9720	(30.8)
3.0 m (10.0 ft)	kg			*15380	14360	*11300	9140	*9350	6330	7130	4100	9.58
	lb			*33910	31660	*24910	20150	*20610	13960	15720	9040	(31.4)
1.5 m (5.0 ft)	kg			*17740	13240	*12640	9140	*10060	6020	7090	4040	9.52
	lb			*39110	29190	*27870	20150	*22180	13270	15630	8910	(31.2)
Ground Line	kg	*13400	*13400	*18580	12720	*13410	8160	10230	5790	7450	4230	9.19
	lb	*29540	*29540	*40960	28040	*29560	17990	22550	12760	16420	9330	(30.2)
-1.5 m (-5.0 ft)	kg	*21020	*21020	*18170	12580	*13400	7990	10120	5690	*8340	4780	8.53
	lb	*46340	*46340	*40060	27730	*29540	17610	22310	12540	*18390	10540	(28.0)
-3.0 m (-10 ft)	kg	*22960	*22960	*16580	12700	*12330	8040			*8180	6030	7.47
	lb	*50620	*50620	*36550	28000	*27180	17730			*18030	13290	(24.5)
-1.5 m (-10 ft)	kg	*17870	*17870	*13110	*13110							
	lb	*39400	*39400	*28900	*28900							

















(3) 6.5 m (21' 4") boom, 2.5 m (8' 2") arm equipped with 1.62 m<sup>3</sup> (SAE heaped) bucket and 600 mm (24") triple grouser shoe and 6500 kg (14330 lb) counterweight.

Load point height		Load radius								At max. reach		
		3.0 m (10.0 ft)		4.5 m (15.0 ft)		6.0 m (20.0 ft)		7.5 m (25.0 ft)		Capacity		Reach
												m (ft)
9.0 m (30.0 ft)	kg									*6820	*6820	7.22
	lb									*15040	*15040	(23.7)
7.5 m (25.0 ft)	kg									*6770	5460	8.49
	lb									*14930	12040	(27.9)
6.0 m (20.0 ft)	kg					*7970	*7970	*7480	6680	*6850	4460	9.29
	lb					*17570	*17570	*16490	14730	*15100	9830	(30.5)
4.5 m (15.0 ft)	kg			*11870	*11870	*9290	*9290	*8060	6420	6880	3930	9.77
	lb			*26170	*26170	*20480	*20480	*17770	14150	15170	8660	(32.1)
3.0 m (10.0 ft)	kg			*15200	13580	*10870	8740	*8870	6090	6520	3670	9.97
	lb			*33510	29940	*23960	19270	*19550	13430	14370	8090	(32.7)
1.5 m (5.0 ft)	kg			*17480	12590	*12250	8170	*9650	5780	6500	3630	9.91
	lb			*38540	27760	*27010	18010	*21270	12740	14330	8000	(32.5)
Ground Line	kg			*18200	12240	*13060	7830	9980	5560	6820	3810	9.59
	lb			*40120	26980	*28790	17260	22000	12260	15040	8400	(31.5)
-1.5 m (-5.0 ft)	kg	*17830	*17830	*17860	12220	*13180	7720	9900	5490	7630	4300	8.97
	lb	*39310	*39310	*39370	26940	*29060	17020	21830	12100	16820	9480	(29.4)
-3.0 m (-10 ft)	kg	*22850	*22850	*16580	12420	*12430	7810			*7850	5340	7.97
	lb	*50380	*50380	*36550	27380	*27400	17220			*17310	11770	(26.1)
-1.5 m (-10 ft)	kg	*18790	*18790	*13880	12880					*7110	*7110	6.39
	lb	*41420	*41420	*30600	28400					*15670	*15670	(21.0)

(4) 6.5 m (21' 4") boom, 3.9 m (12' 10") arm equipped with 1.62 m<sup>3</sup> (SAE heaped) bucket and 600 mm (24") triple grouser shoe and 6500 kg (14330 lb) counterweight.

Load point height		Load radius												At max. reach						
		1.5 m (5.0 ft)		3.0 m (10.0 ft)		4.5 m (15.0 ft)		6.0 m (20.0 ft)		7.5 m (25.0 ft)		9.0 m (30.0 ft)		Capacity		Reach				
																		m (ft)		
9.0 m (30 ft)	kg																	*5220	*5220	8.81
	lb																	*11510	*11510	(28.9)
7.5 m (25.0 ft)	kg																	*5320	4220	9.85
	lb																	*11730	9300	(32.3)
6.0 m (20.0 ft)	kg									*5820	*5820	*3620	*3620	*5490	3550	10.54				
	lb									*12830	*12830	*7980	*7980	*12100	7830	(34.6)				
4.5 m (15.0 ft)	kg									*6570	*6570	*5410	4680	*5660	3160	10.95				
	lb									*14480	*14480	*11930	10320	*12480	6970	(35.9)				
3.0 m (10.0 ft)	kg			*19700	*19700	*11910	*11910	*9000	*9000	*7540	6240	*6730	4460	5390	2950	11.13				
	lb			*43430	*43430	*26260	*26260	*19840	*19840	*16620	13760	*14840	9830	11880	6500	(36.5)				
1.5 m (5.0 ft)	kg			*12690	*12690	*15110	13210	*10740	8390	*8560	5830	*7320	4230	5330	2890	11.07				
	lb			*27980	*27980	*33310	29120	*23680	18500	*18870	12850	*16140	9330	11750	6370	(36.3)				
Ground Line	kg			*13710	*13710	*17120	12340	*12090	7860	*9410	5500	7350	4040	5510	2970	10.79				
	lb			*30230	*30230	*37740	27210	*26650	17330	*20750	12130	16200	8910	12150	6550	(35.4)				
-1.5 m (-5.0 ft)	kg	*12630	*12630	*16860	*16860	*17890	11970	*12830	7550	9710	5300	7220	3930	5970	3240	10.26				
	lb	*27840	*27840	*37170	*37170	*39440	26390	*28290	16640	21410	11680	15920	8660	13160	7140	(33.7)				
-3.0 m (-10.0 ft)	kg	*16240	*16240	*21070	*21070	*17610	11920	*12860	7450	9630	5230			6900	3810	9.42				
	lb	*35800	*35800	*46450	*46450	*38820	26280	*28350	16420	21230	11530			15210	8400	(30.9)				
-4.5 m (-15.0 ft)	kg	*20300	*20300	*23540	*23540	*16240	12130	*11980	7560	*8980	5360			*7360	4970	8.17				
	lb	*44750	*44750	*51900	*51900	*35800	26740	*26410	16670	*19800	11820			*16230	10960	(26.8)				
-6.0 m (-20.0 ft)	kg			*18730	*18730	*13200	12640													
	lb			*41290	*41290	*29100	27870													

(5) 6.5 m (21' 4") boom, 4.3 m (14' 1") arm equipped with 1.62 m<sup>3</sup> (SAE heaped) bucket and 600 mm (24") triple grouser shoe and 6500 kg (14330 lb) counterweight.

Load point height		Load radius												At max. reach						
		1.5 m (5.0 ft)		3.0 m (10.0 ft)		4.5 m (15.0 ft)		6.0 m (20.0 ft)		7.5 m (25.0 ft)		9.0 m (30.0 ft)		10.5 m (35.0 ft)		Capacity		Reach		
																		m (ft)		
9.0 m (30 ft)	kg																	*4970	4590	9.45
	lb																	*10960	10250	(31.0)
7.5 m (25.0 ft)	kg											*2710	*2710					*4770	3710	10.42
	lb											*5970	*5970					*10520	8180	(34.2)
6.0 m (20.0 ft)	kg											*4420	*4420					*4670	3150	11.07
	lb											*9740	*9740					*10300	6940	(36.3)
4.5 m (15.0 ft)	kg									*6030	*6030	*5580	4730					*4690	2820	11.46
	lb									*13290	*13290	*12300	10430					*10340	6220	(37.6)
3.0 m (10.0 ft)	kg			*16870	*16870	*10740	*10740	*8310	*8310	*7050	6310	*6340	4490	*2620	*2620	*4830	2640	11.63		
	lb			*37190	*37190	*23680	*23680	*18320	*18320	*15540	13910	*13980	9900	*5780	*5780	*10650	5820	(38.2)		
1.5 m (5.0 ft)	kg			*13700	*13700	*14150	13480	*10140	8500	*8130	5870	*6980	4230	*2950	*2950	4880	2580	11.58		
	lb			*30200	*30200	*31200	29720	*22350	18740	*17920	12940	*15390	9330	*6500	*6500	10760	5690	(38.0)		
Ground Line	kg			*13070	*13070	*16510	12440	*11640	7900	*9070	5510	7330	4010			5030	2660	11.31		
	lb			*28810	*28810	*36400	27430	*25660	17420	*20000	12150	16160	8840			11090	5860	(37.1)		
-1.5 m (-5.0 ft)	kg	*11110	*11110	*15450	*15450	*17630	11930	*12570	7520	9670	5260	7170	3860			5420	2890	10.81		
	lb	*24490	*24490	*34060	*34060	*38870	26300	*27710	16580	21320	11600	15810	8510			11950	6370	(35.5)		
-3.0 m (-10.0 ft)	kg	*14410	*14410	*19090	*19090	*17690	11790	*12820	7360	9550	5150	*6600	3830			6180	3350	10.02		
	lb	*31770	*31770	*42090	*42090	*39000	25990	*28260	16230	21050	11350	*14550	8440			13620	7390	(32.9)		
-4.5 m (-15.0 ft)	kg	*18210	*18210	*24070	*24070	*16690	11930	*12250	7420	*9310	5120					*6710	4250	8.87		
	lb	*40150	*40150	*53070	*53070	*36800	26300	*27010	16360	*20530	11490					*14790	9370	(29.1)		
-6.0 m (-20.0 ft)	kg	*22860	*22860	*20530	*20530	*14250	12340	*10350	7720							*6520	6360	7.15		
	lb	*50400	*50400	*45260	*45260	*31420	27210	*22820	17020							*14370	14020	(23.5)		

(6) 8.6 m (28' 3") boom, 5.1 m (16' 9") arm equipped with 1.46 m<sup>3</sup> (SAE heaped) bucket and 600 mm (24") triple grouser shoe and 8100 kg (17860 lb) counterweight.

Load point height	Load radius																At max. reach						
	1.5 m (5.0 ft)		3.0 m (10.0 ft)		4.5 m (15.0 ft)		6.0 m (20.0 ft)		7.5 m (25.0 ft)		9.0 m (30.0 ft)		10.5 m (35.0 ft)		12.0 m (40.0 ft)		13.5 m (45.0 ft)		Capacity		Reach		
																						m (ft)	
9.0 m (30 ft)	kg													*3010	*3010						*3030	2560	12.91
	lb													*6640	*6640						*6680	5640	(42.4)
7.5 m (25.0 ft)	kg													*3110	*3110	*2630	*2630				*3100	2140	13.61
	lb													*6860	*6860	*5800	*5800				*6830	4720	(44.7)
6.0 m (20.0 ft)	kg													*3360	*3360	*3300	2870				*3180	1860	14.10
	lb													*7410	*7410	*7280	6330				*7010	4100	(46.3)
4.5 m (15.0 ft)	kg											*4100	*4100	*3730	3730	*3520	2730				*3290	1680	14.40
	lb											*9040	*9040	*8220	8220	*7760	6020				*7250	3700	(47.2)
3.0 m (10.0 ft)	kg				*10920	*10920	*7400	*7400	*5710	*5710	*4750	4690	*4160	3460	*3790	2560	*1720	*1720			3360	1560	14.53
	lb				*24070	*24070	*16310	*16310	*12590	*12590	*10470	10340	*9170	7630	*8360	5640	*3790	*3790			7410	3440	(47.7)
1.5 m (5.0 ft)	kg				*10890	*10890	*8990	8230	*6710	5840	*5420	4300	*4610	3210	*4090	2400	*1900	1770			3310	1520	14.49
	lb				*24010	*24010	*19820	18140	*14790	12870	*11950	9480	*10160	7080	*9020	5290	*4190	3900			7300	3350	(47.5)
Ground Line	kg				*10400	*10400	*10190	7550	*7560	5370	*6010	3970	*5030	2990	*4370	2260					3370	1540	14.28
	lb				*22930	*22930	*22470	16640	*16670	11840	*13250	8750	*11090	6590	*9630	4980					7430	3400	(46.9)
-1.5 m (-5.0 ft)	kg			*7990	*7990	*11720	11360	*10930	7170	*8180	5050	*6480	3730	*5370	2820	4450	2150				3520	1630	13.90
	lb			*17610	*17610	*25840	25040	*24100	15810	*18030	11130	*14290	8220	*11840	6220	9810	4740				7760	3590	(45.6)
-3.0 m (-10.0 ft)	kg	*8910	*8910	*10270	*10270	*13880	11320	*11250	7010	*8540	4880	*6780	3600	5490	2730	4410	2110				3820	1810	13.31
	lb	*19640	*19640	*22640	*22640	*30600	24960	*24800	15450	*18830	10760	*14950	7940	12100	6020	9720	4650				8420	3990	(43.7)
-4.5 m (-15.0 ft)	kg	*11090	*11090	*12810	*12810	*15320	11460	*11200	7020	*8610	4840	*6850	3560	5480	2710						4230	2130	12.50
	lb	*24450	*24450	*28240	*28240	*33770	25260	*24690	15480	*18980	10670	*15100	7850	12080	5970						9330	4700	(41.0)
-6.0 m (-20.0 ft)	kg	*13540	*13540	*15800	*15800	*14460	11750	*10750	7160	*8340	4930	*6630	3630	*5260	2820						4390	2660	11.41
	lb	*29850	*29850	*34830	*34830	*31880	25900	*23700	15790	*18390	10870	*14620	8000	*11600	6220						9680	5860	(37.4)
-7.5 m (-25.0 ft)	kg	*16440	*16440	*18490	*18490	*12970	12210	*9770	7460	*7580	5160	*5850	3860								4450	3630	9.94
	lb	*36240	*36240	*40760	*40760	*28590	26920	*21540	16450	*16710	11380	*12900	8510								9810	8000	(32.6)
-9.0 m (-30.0 ft)	kg			*14620	*14620	*10500	*10500	*7900	*7900	*5800	5630												
	lb			*32230	*32230	*23150	*23150	*17420	*17420	*12790	12410												

## 6. BUCKET SELECTION GUIDE

### 1) GENERAL BUCKET

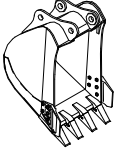
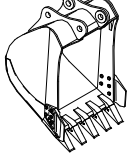
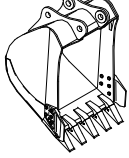
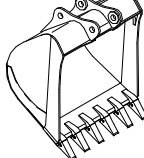
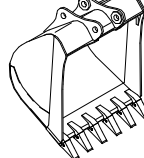
				
1.46 m <sup>3</sup> SAE heaped bucket	※ 1.62 m <sup>3</sup> SAE heaped bucket	1.90 m <sup>3</sup> SAE heaped bucket	2.10 m <sup>3</sup> SAE heaped bucket	2.32 m <sup>3</sup> SAE heaped bucket

Capacity m <sup>3</sup> (yd <sup>3</sup> )				Width mm (in)		Weight kg (lb)		Tooth EA	Recommendation mm (ft-in)						
									6150 (20' 2") boom	6500 (21' 4") boom					8600 (28' 3") boom
SAE heaped		CECE heaped							2500 (8' 2") arm	2500 (8' 2") arm	2900 (9' 6") arm	3200 (10' 6") arm	3900 (12' 10") arm	4300 (14' 1") arm	5100 (16' 9") arm
1.46	(1.91)	1.28	(1.67)	1370	(54")	1430	(3150)	4	●	●	●	●	◐	■	▲
※ 1.62	(2.12)	1.42	(1.86)	1480	(58")	1530	(3370)	5	●	●	●	◐	■	■	
1.90	(2.49)	1.65	(2.16)	1665	(66")	1640	(2450)	5	●	◐	◐	■	▲	▲	
2.10	(2.75)	1.84	(2.41)	1800	(71")	1720	(3790)	5	◐	■	■	■	▲		
2.32	(3.03)	2.02	(2.64)	1950	(77")	1830	(4030)	6	■	■	▲	▲			

※ : Standard bucket

- Applicable for materials with density of 2100 kg/m<sup>3</sup> (3500 lb/yd<sup>3</sup>) or less
- ◐ Applicable for materials with density of 1800 kg/m<sup>3</sup> (3000 lb/yd<sup>3</sup>) or less
- Applicable for materials with density of 1500 kg/m<sup>3</sup> (2500 lb/yd<sup>3</sup>) or less
- ▲ Applicable for materials with density of 1200 kg/m<sup>3</sup> (2000 lb/yd<sup>3</sup>) or less

## 2) HEAVY DUTY AND ROCK-HEAVY DUTY BUCKET

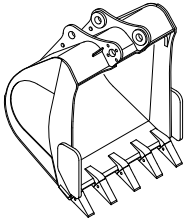
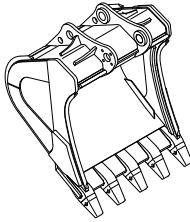
	
<p>◆ 1.62 m<sup>3</sup> SAE          ◆ 1.90 m<sup>3</sup> SAE          ◆ 2.10 m<sup>3</sup> SAE          heaped bucket</p>	<p>◎ 1.62 m<sup>3</sup> SAE          ◎ 1.90 m<sup>3</sup> SAE          heaped bucket</p>

Capacity m <sup>3</sup> (yd <sup>3</sup> )				Width mm (in)		Weight kg (lb)		Tooth EA	Recommendation mm (ft-in)					
									6150 (20' 2") boom	6500 (21' 4") boom				
SAE heaped		CECE heaped							2500 (8' 2") arm	2500 (8' 2") arm	2900 (9' 6") arm	3200 (10' 6") arm	3900 (12' 10") arm	4300 (14' 1") arm
◆1.62	(2.12)	1.42	(1.86)	1480	(58")	1660	(3660)	5	●	●	●	◐	■	▲
◆1.90	(2.49)	1.65	(2.16)	1665	(66")	1790	(3950)	5	●	◐	■	■	▲	▲
◆2.10	(2.75)	1.84	(2.41)	1800	(71")	1880	(4140)	5	◐	■	■	▲	▲	
◎1.62	(2.12)	1.42	(1.86)	1480	(58")	1850	(4080)	5	●	●	◐	◐		
◎1.90	(2.49)	1.65	(2.16)	1665	(66")	1990	(4390)	5	◐	◐	■	■		

◆ : Heavy duty bucket

◎ : Rock-heavy duty bucket

● Applicable for materials with density of 2100 kg/m<sup>3</sup> (3500 lb/yd<sup>3</sup>) or less

◐ Applicable for materials with density of 1800 kg/m<sup>3</sup> (3000 lb/yd<sup>3</sup>) or less

■ Applicable for materials with density of 1500 kg/m<sup>3</sup> (2500 lb/yd<sup>3</sup>) or less

▲ Applicable for materials with density of 1200 kg/m<sup>3</sup> (2000 lb/yd<sup>3</sup>) or less

## 7. UNDERCARRIAGE

### 1) TRACKS

X-leg type center frame is integrally welded with reinforced box-section track frames. The design includes dry tracks, lubricated rollers, idlers, sprockets, hydraulic track adjusters with shock absorbing springs and assembled track-type tractor shoes with triple grousers.

### 2) TYPES OF SHOES

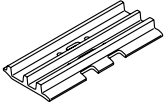
Model	Shapes		Triple grouser				
							
R380LC-9SH	Shoe width	mm (in)	600 (24)	700 (28)	750 (30)	800 (32)	900 (36)
	Operating weight	kg (lb)	38400 (84660)	38850 (85650)	39075 (86140)	39300 (86640)	39750 (87630)
	Ground pressure	kgf/cm <sup>2</sup> (psi)	0.69 (9.81)	0.60 (8.53)	0.56 (7.96)	0.53 (7.54)	0.47 (6.68)
	Overall width	mm (ft-in)	3340 (10' 11")	3440 (11' 3")	3490 (11' 5")	3540 (11' 7")	3640 (11' 11")

### 3) NUMBER OF ROLLERS AND SHOES ON EACH SIDE

Item	Quantity
Carrier rollers	2 EA
Track rollers	9 EA
Track shoes	51 EA

#### 4) SELECTION OF TRACK SHOE

Suitable track shoes should be selected according to operating conditions.

##### Method of selecting shoes

Confirm the category from the list of applications in table 2, then use table 1 to select the shoe.

Wide shoes (categories B and C) have limitations on applications. Before using wide shoes, check the precautions, then investigate and study the operating conditions to confirm if these shoes are suitable.

Select the narrowest shoe possible to meet the required flotation and ground pressure.

Application of wider shoes than recommendations will cause unexpected problem such as bending of shoes, crack of link, breakage of pin, loosening of shoe bolts and the other various problems.

※ Table 1

Track shoe	Specification	Category
600 mm triple grouser	Standard	A
700 mm triple grouser	Option	B
750 mm triple grouser	Option	B
800 mm triple grouser	Option	C
900 mm triple grouser	Option	C

※ Table 2

Category	Applications	Applications
A	Rocky ground, river beds, normal soil	<ul style="list-style-type: none"> <li>Travel at low speed on rough ground with large obstacles such as boulders or fallen trees</li> </ul>
B	Normal soil, soft ground	<ul style="list-style-type: none"> <li>These shoes cannot be used on rough ground with large obstacles such as boulders or fallen trees</li> <li>Travel at high speed only on flat ground</li> <li>Travel slowly at low speed if it is impossible to avoid going over obstacles</li> </ul>
C	Extremely soft ground (swampy ground)	<ul style="list-style-type: none"> <li>Use the shoes only in the conditions that the machine sinks and it is impossible to use the shoes of category A or B</li> <li>These shoes cannot be used on rough ground with large obstacles such as boulders or fallen trees</li> <li>Travel at high speed only on flat ground</li> <li>Travel slowly at low speed if it is impossible to avoid going over obstacles</li> </ul>



### 3) GEAR PUMP

Item	Specification
Type	Fixed displacement gear pump single stage
Capacity	15cc/rev
Maximum pressure	40 kgf/cm <sup>2</sup> (570 psi)
Rated oil flow	24 ℓ /min (6.34 U.S. gpm/5.28 U.K. gpm)

### 4) MAIN CONTROL VALVE

Item	Specification
Type	9 spools
Operating method	Hydraulic pilot system
Main relief valve pressure	330 kgf/cm <sup>2</sup> (4690 psi) [360 kgf/cm <sup>2</sup> (5120 psi)]
Overload relief valve pressure	380 kgf/cm <sup>2</sup> (5400 psi)

[ ]: Power boost

### 5) SWING MOTOR

Item	Specification	
Machine serial No.	-#0893	#0894-
Type	Axial piston motor	
Capacity	233 cc/rev	240 cc/rev
Relief pressure	290 kgf/cm <sup>2</sup> (4120 psi)	
Braking system	Automatic, spring applied hydraulic released	
Braking torque	107 kgf · m (773 lbf · ft)	134 kgf · m (969 lbf · ft)
Brake release pressure	30~50 kgf/cm <sup>2</sup> (427~711 psi)	26 kgf/cm <sup>2</sup> (370 psi)
Reduction gear type	2 - stage planetary	

### 6) TRAVEL MOTOR

Item	Specification
Type	Variable displacement axial piston motor
Relief pressure	360 kgf/cm <sup>2</sup> (5120 psi)
Capacity (max / min)	185.2/114.2 cc/rev
Reduction gear type	3-stage planetary
Braking system	Automatic, spring applied hydraulic released
Brake release pressure	8.5 kgf/cm <sup>2</sup> (121 psi)
Braking torque	44.4 kgf · m (321 lbf · ft)

### 3) GEAR PUMP

Item	Specification
Type	Fixed displacement gear pump single stage
Capacity	15cc/rev
Maximum pressure	40 kgf/cm <sup>2</sup> (570 psi)
Rated oil flow	24 l /min (6.34 U.S. gpm/5.28 U.K. gpm)

### 4) MAIN CONTROL VALVE

Item	Specification
Type	9 spools
Operating method	Hydraulic pilot system
Main relief valve pressure	330 kgf/cm <sup>2</sup> (4690 psi) [360 kgf/cm <sup>2</sup> (5120 psi)]
Overload relief valve pressure	380 kgf/cm <sup>2</sup> (5400 psi)

[ ]: Power boost

### 5) SWING MOTOR

Item	Specification
Type	Axial piston motor
Capacity	233 cc/rev
Relief pressure	290 kgf/cm <sup>2</sup> (4120 psi)
Braking system	Automatic, spring applied hydraulic released
Braking torque	107 kgf · m (773 lbf · ft)
Brake release pressure	30~50 kgf/cm <sup>2</sup> (427~711 psi)
Reduction gear type	2 - stage planetary

### 6) TRAVEL MOTOR

Item	Specification
Type	Variable displacement axial piston motor
Relief pressure	360 kgf/cm <sup>2</sup> (5120 psi)
Capacity (max / min)	185.2/114.2 cc/rev
Reduction gear type	3-stage planetary
Braking system	Automatic, spring applied hydraulic released
Brake release pressure	8.5 kgf/cm <sup>2</sup> (121 psi)
Braking torque	44.4 kgf · m (321 lbf · ft)

## 7) CYLINDER

Item		Specification
Boom cylinder	Bore dia × Stroke	∅ 160 × 1500 mm
	Cushion	Extend only
Arm cylinder	Bore dia × Stroke	∅ 170 × 1760 mm
	Cushion	Extend and retract
Bucket cylinder	Bore dia × Stroke	∅ 150 × 1295 mm
	Cushion	Extend only

※ Discoloration of cylinder rod can occur when the friction reduction additive of lubrication oil spreads on the rod surface.

※ Discoloration does not cause any harmful effect on the cylinder performance.

## 8) SHOE

Item		Width	Ground pressure	Link quantity	Overall width
R380LC-9SH	Standard	600 mm (24")	0.69 kgf/cm <sup>2</sup> (9.81 psi)	51	3340 mm (10' 11")
	Option	700 mm (28")	0.60 kgf/cm <sup>2</sup> (8.53 psi)	51	3440 mm (11' 3")
		750 mm (30")	0.56 kgf/cm <sup>2</sup> (7.96 psi)	51	3490 mm (11' 5")
		800 mm (32")	0.53 kgf/cm <sup>2</sup> (7.54 psi)	51	3540 mm (11' 7")
		900 mm (36")	0.47 kgf/cm <sup>2</sup> (6.68 psi)	51	3640 mm (11' 11")

## 9) BUCKET

Item		Capacity m <sup>3</sup> (yd <sup>3</sup> )				Tooth quantity EA	Width mm (in)	
		SAE heaped		CECE heaped				
R380LC-9SH	Standard	1.62	(2.12)	1.42	(1.86)	5	1530	(3370)
	Option	1.46	(1.91)	1.28	(1.67)	4	1430	(3150)
		1.90	(2.49)	1.65	(2.16)	5	1640	(2450)
		2.10	(2.75)	1.84	(2.41)	5	1720	(3790)
		2.32	(3.03)	2.02	(2.64)	6	1830	(4030)
		◆ 1.62	(2.12)	1.42	(1.86)	5	1660	(3660)
		◆ 1.90	(2.49)	1.65	(2.16)	5	1790	(3950)
		◆ 2.10	(2.75)	1.84	(2.41)	5	1880	(4140)
		◎ 1.62	(2.12)	1.42	(1.86)	5	1850	(4080)
		◎ 1.90	(2.49)	1.65	(2.16)	5	1990	(4390)

◆ : Heavy duty bucket

◎ : Rock bucket (esco type)

## 9. RECOMMENDED OILS

Use only oils listed below. Do not mix different brand oil.

Please use HYUNDAI genuine oil and grease.

Service point	Kind of fluid	Capacity ℓ (U.S. gal)	Ambient temperature °C (°F)						
			-50 (-58)	-30 (-22)	-20 (-4)	-10 (14)	0 (32)	10 (50)	20 (68)
Engine oil pan	Engine oil	27.3 (7.2)	★SAE 5W-40						
			SAE 30						
			SAE 10W						
			SAE 10W-30						
			SAE 15W-40						
Swing drive	Gear oil	8.0 (2.1)	★SAE 75W-90						
Final drive		4.3×2 (1.1×2)	SAE 80W-90						
Hydraulic tank	Hydraulic oil	Tank; 210 (55.5)  System; 410 (108.3)	★ISO VG 15						
			ISO VG 32						
			ISO VG 46						
			ISO VG 68						
Fuel tank	Diesel fuel	550 (145)	★ASTM D975 NO.1						
			ASTM D975 NO.2						
Fitting (grease nipple)	Grease	As required	★NLGI NO.1						
			NLGI NO.2						
Radiator (reservoir tank)	Mixture of antifreeze and water	52 (13.7)	Ethylene glycol base permanent type (50 : 50)						
			★Ethylene glycol base permanent type (60 : 40)						

**SAE** : Society of Automotive Engineers

★ : Arctic machine

**API** : American Petroleum Institute

**ISO** : International Organization for Standardization

**NLGI** : National Lubricating Grease Institute

**ASTM** : American Society of Testing and Material