

## GROUP 6 TRAVEL DEVICE

### 1. REMOVAL AND INSTALL

#### 1) REMOVAL

- (1) Swing the work equipment 90° and lower it completely to the ground.
- (2) Operate the control levers and pedals several times to release the remaining pressure in the hydraulic piping.
- (3) Loosen the breather slowly to release the pressure inside the hydraulic tank.

**▲ Escaping fluid under pressure can penetrate the skin causing serious injury.**

※ When pipes and hoses are disconnected, the oil inside the piping will flow out, so catch it in oil pan.

- (4) Remove the track shoe assembly.  
For details, see **removal of track shoe assembly**.
- (5) Remove the cover.
- (6) Remove the hoses.  
※ Fit blind plugs to the disconnected hoses.
- (7) Remove the bolts and the sprocket.
- (8) Sling travel device assembly(1).
- (9) Remove the mounting bolts(2), then remove the travel device assembly.  
· Weight : 380kg(840lb)

#### 2) INSTALL

- (1) Carry out installation in the reverse order to removal.
- (2) Bleed the air from the travel motor.
  - ① Remove the air vent plug.
  - ② Pour in hydraulic oil until it overflows from the port.
  - ③ Tighten plug lightly.
  - ④ Start the engine, run at low idling, and check oil come out from plug.
  - ⑤ Tighten plug fully.
- (3) Confirm the hydraulic oil level and check the hydraulic oil leak or not.

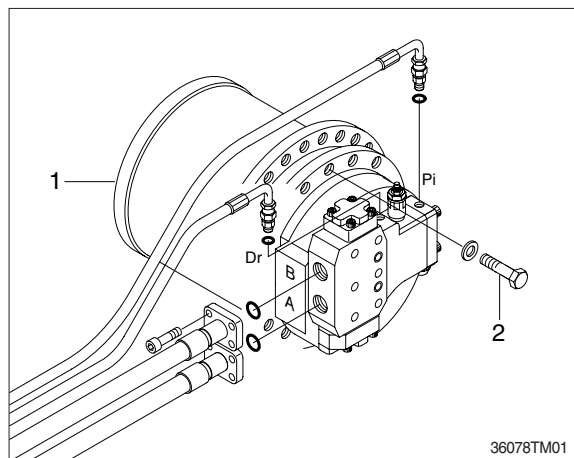

## 2. TRAVEL MOTOR

### 1) STRUCTURE(1/2)

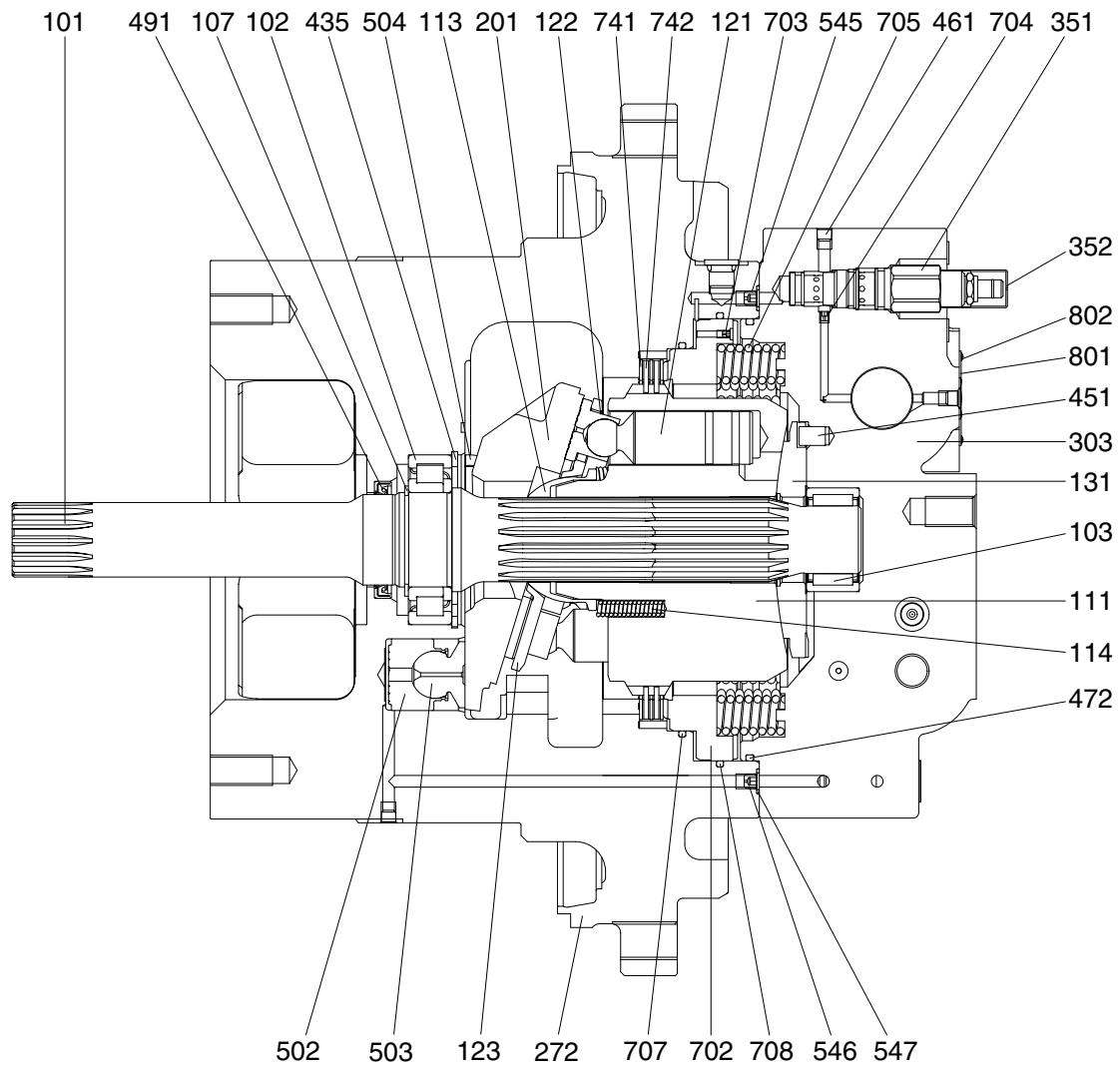

3607A2TM02

101 Drive shaft	303 Valve casing	547 O-ring
102 Roller bearing	351 Reducing valve	702 Brake piston
103 Needle bearing	352 Cover	703 Orifice
107 Snap ring	435 Snap ring	704 Orifice
111 Cylinder block	451 Pin	705 Brake spring
113 Spherical bushing	461 Plug	707 O-ring
114 Cylinder spring	472 O-ring	708 O-ring
121 Piston	491 Oil seal	741 Separation plate
122 Shoe	502 Piston	742 Friction plate
123 Set plate	503 Shoe	801 Name plate
131 Valve plate	504 Pivot ball	802 Rivet
201 Swash plate	545 Orifice	
272 Shaft casing	546 Orifice	

## STRUCTURE(2/2)

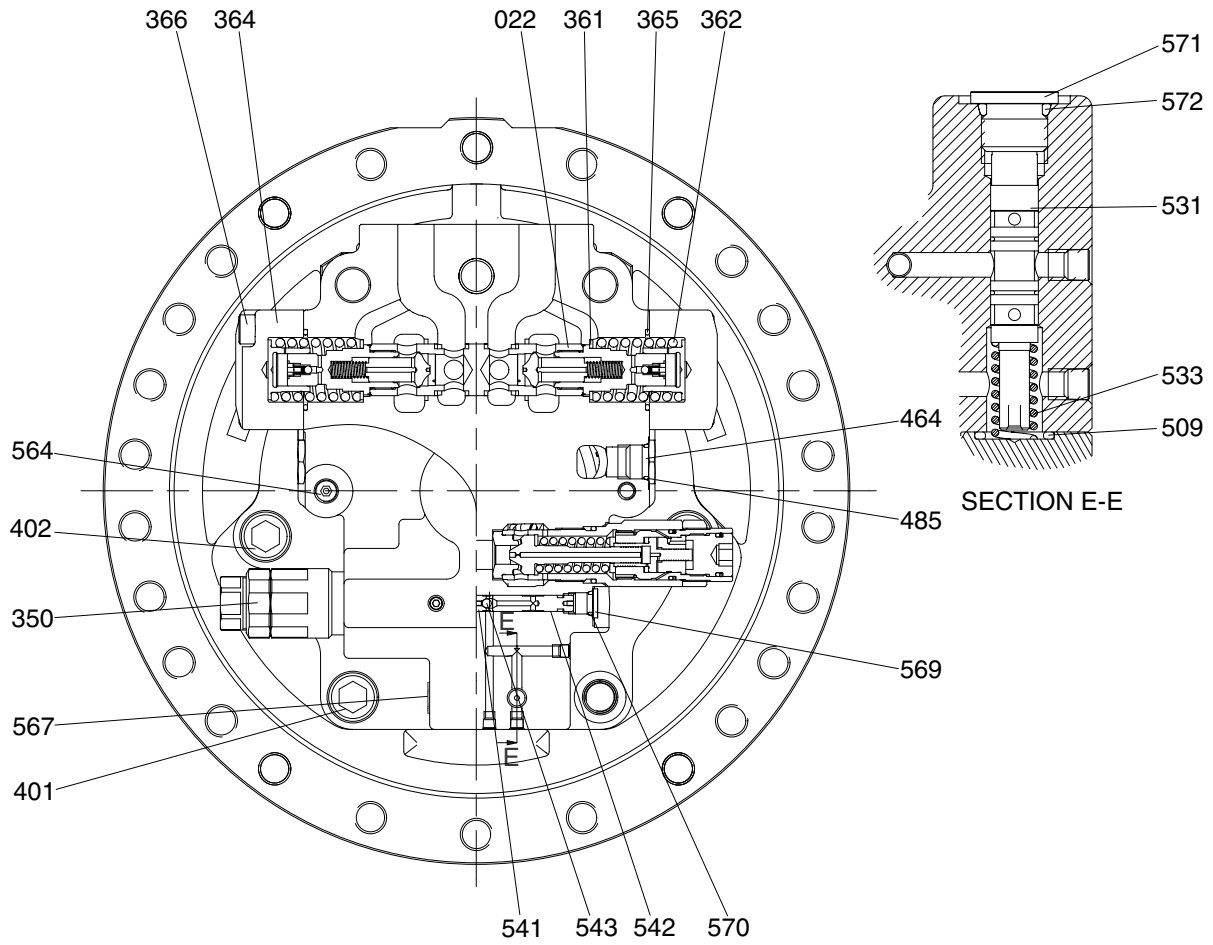

37007TM03

022	Counterbalance spool	402	Hex socket bolt	543	Steel ball
350	Relief valve	464	VP plug	564	Plug
361	Washer	485	O-ring	567	VP plug
362	Counterbalance spring	509	O-ring	569	RO plug
364	Counterbalance cover	531	Tilting spool	570	O-ring
365	O-ring	533	Tilting spring	571	RO plug
366	Hex socket bolt	541	Seat	572	O-ring
401	Hex socket bolt	542	Stopper	702	Brake piston

## 2) TOOLS AND TIGHTENING TORQUE

### (1) Tools

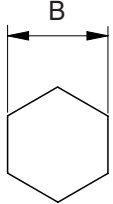
Tool name	Remark		
Allen wrench	2		
	2.5		
	4		
	6		
	8		
	10		
	17		
Socket for socket wrench, spanner	19		
	22.4		
	27		
	42		
Torque wrench	Capable of tightening with the specified torques.		
Plier(For hole, TPR-90)	For snap ring(435)		
Plier(For shaft)	For snap ring(107)		
( - ) Driver	-		
Plastic hammer	Wooden hammer allowed. Nominal 1 or so		
Steel rod approx	7×7×200mm, Bearing(102, 103)		
Monkey wrench	-		
Oil seal inserting jig	-		
Bearing plier	-		
Seal tape	-		

### (2) Tightening torque

Part name	Item	Size	Torque		Wrench size	
			kgf · m	lbf · ft	in	mm
Socket bolt	366	M12×45	10	72.3	0.39	10
Socket bolt	401	M20×100	44	318	0.67	17
Socket bolt	402	M20×50	44	318	0.67	17
Plug	461	NPTF 1/16	0.9	6.5	0.16	4
VP Plug	464	PF 1/4	11	79.6	1.06	27
Orifice	545, 546	NPTF 1/16	0.7	5.1	0.16	4
Plug	564	PT 1/2	2.2	15.9	0.24	6
VP Plug	567	PF 1/4	3.7	26.8	0.75	19
Plug	569	PF 1/4	3.7	26.8	0.24	6
Plug	571	PF 3/8	7.5	54.2	0.31	8
Orifice	703	M4×0.7	0.35	2.5	0.08	2
Orifice	704	M5×0.8	0.7	5.1	0.1	2.5



### 3. TRAVEL REDUCTION GEAR

#### 1) STRUCTURE

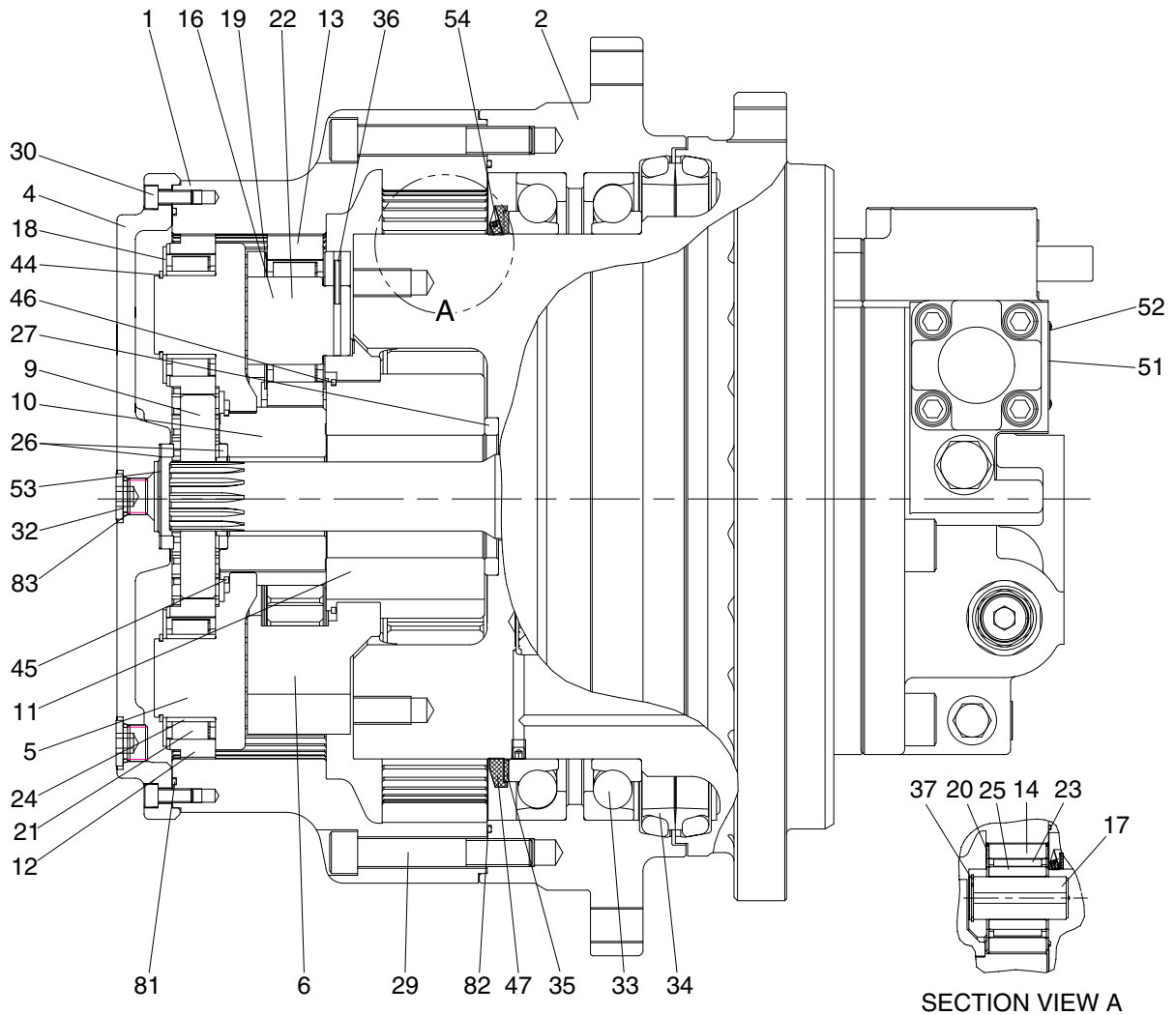

1	Ring gear	19	Side plate	35	Shim
2	Housing	20	Side plate	36	Spring pin
4	Side cover	21	Needle cage	37	Snap ring
5	Carrier 1	22	Needle cage	44	Snap ring
6	Carrier 2	23	Needle cage	45	Clip
9	Sun gear 1	24	Inner ring	46	W clip
10	Sun gear 2	25	Floating bushing	47	Nut ring
11	Sun gear 3	26	Thrust ring	51	Name plate
12	Planetary gear 1	27	Thrust ring	52	Rivet
13	Planetary gear 2	29	Socket bolt	53	Washer
14	Planetary gear 3	30	Socket bolt	54	Set screw
16	Pin 2	32	RO plug	81	O-ring
17	Pin 3	33	Angular bearing	82	O-ring
18	Side plate	34	Floating seal	83	O-ring

37007TRG01

## 2) TOOLS AND TIGHTENING TORQUE

### (1) Tools

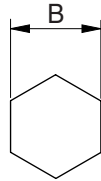
Tool name	Remark	
Allen wrench	4	
	8	
	10	
	14	
Spanner	27	
Torque wrench	Capable of tightening with the specified torques.	
Plier(For shaft)	Snap ring(037, 044)	
( - ) Driver	For removing floating seal	
Plastic hammer	Wooden hammer allowed	
Eye bolt	M8, M10, M16, M20, For lifting-up	
Press(1 ton)	Angular bearing(033)	
Depth gauge straight edge	100mm depth, for adjusting shins(053)	
Tap M16	For removing screw lock in tapped holes	
Oil stone	For finishing mating faces	
Punch	For preventing spring pin from coming out	
Loctite(Three bond 1373B)	Set screw(054)	
Loctite	Socket bolt(029)	
Nut ring inserting jig	Nut ring(047)	

### (2) Tightening torque

Part name	Item	Size	Torque		Wrench size	
			kgf · m	lbf · ft	in	mm
Socket bolt	29	M16×100	30	217	0.55	14
	30	M8×20	3.5	25.3	0.24	6
Plug	32	PF 1/2	11	79.6	0.39	10
Set screw	54	M8×16	1.0	7.2	0.24	6

## 4. DISASSEMBLING

### 1) GENERAL PRECAUTIONS

- (1) Pay attention to not damaging contact surfaces for O-rings, oil seals, etc. and contact/sliding surfaces for gears, pins, bearings, etc.
- (2) This motor can be disassembled even in a state on the reduction gear.  
However, in that case, pay full attention to preventing mud, dust, etc. from entering in it.
- (3) The numerical in parentheses following each part name indicates its part number shown in the attached **assembly drawings**.
- (4) The piping side of the motor is referred to as the rear side, and the output side as the front side.

### 2) DISASSEMBLY OF REDUCTION GEAR

- (1) Select a disassembling place.
  - ※ Select a clean place.
  - ※ Spread rubber sheet or cloth on work bench to prevent parts from being damaged.
- (2) Remove dust, mud, etc. from reduction gear surfaces with washing oil or so.
- (3) Place reduction gear with its gear oil drain port or level gauge at the lowest position, and drain reduction gear oil.
  - ※ Receive gear oil with clean vessel and check it for abnormalities.  
Renew gear oil.
- (4) Place reduction gear with its side cover (4) upward, and remove socket bolt(30), and remove side cover(4) and O-ring(81).



370078TM01

- (5) Remove sun gear 1(9).

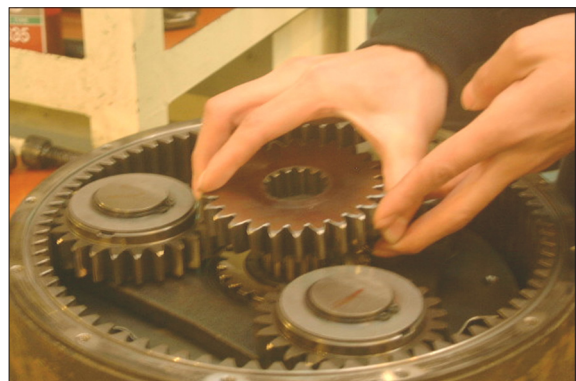

370078TM02

- (6) Remove carrier 1(5), together with planetary gears 1(12), sun gear 2(10), etc. fitted.



370078TM03

**(7) Disassembling of carrier 1 sub-assembly**

- ① Remove snap ring(44), and then remove side plate (18), planetary gear 1 (12), needle cage(21) and side plate(18).

※ If flaking is observed on the inner ring surface replace inner ring. In this case, replace planetary gear 1 and needle cage simultaneously.



370078TM04

- ② Remove circlip(45), and then remove carrier 1(5) from sun gear 2(10).

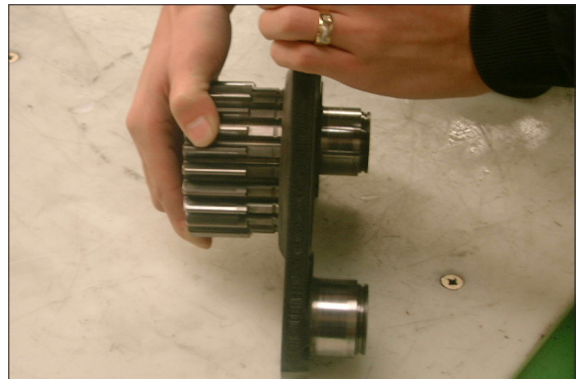

370078TM05

- ③ Remove thrust ring(26).

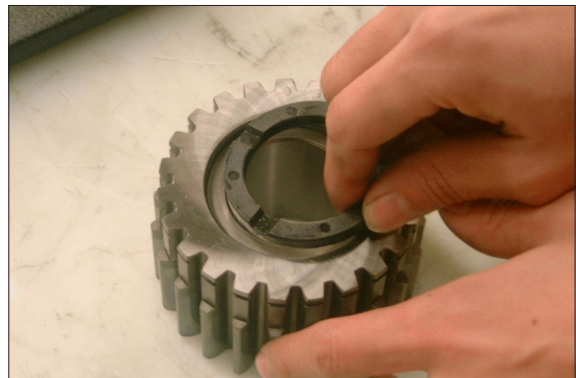

370078TM06



(8) Remove carrier 2(6), with planetary gears 2(13), sun gear 3(11), etc. fitted.

※ Use M10 eyebolt. In this case, thrust ring(26) is removed simultaneously.

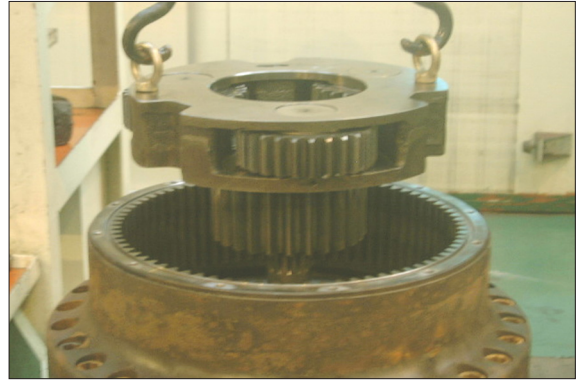

370078TM07

### (9) Disassembling of carrier 2 sub-assembly

① Push in spring pin(36), and remove pin 2(16), from carrier 2.

※ Carry out the following check in advance. If any abnormality should be found, carry out disassembling.

- Is there any crevice, crack or pitting on tooth surface of planetary gear?
- When turning planetary gear lightly, is there any abnormal noise or eccentric clearance? Carry out check similarly to the above for carrier 3.

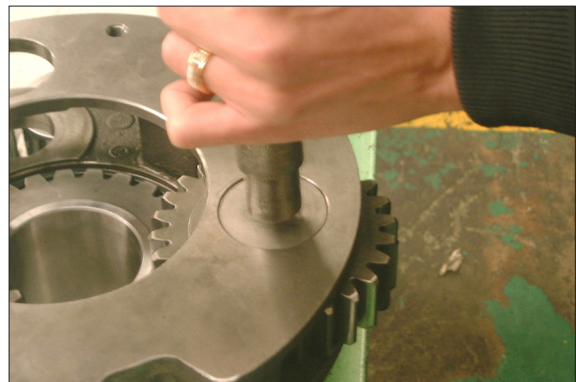

370078TM08

② Remove side plate(20), planetary gear 2(13), and needle bearing(22) from carrier 2.

③ Remove thrust ring(26).

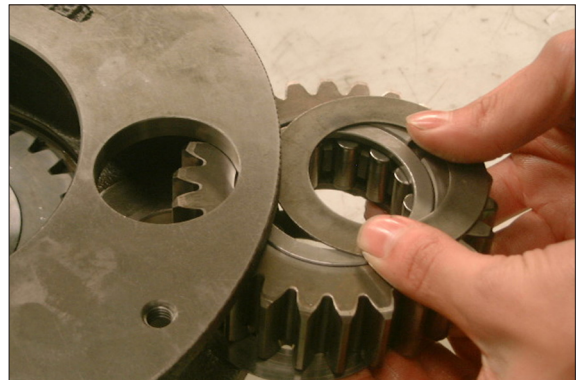

370078TM09

④ Remove snap ring(46), and remove carrier 2(6) from sun gear 3(11).

⑤ Remove thrust ring(27) from sun gear 3(11).



370078TM10

(10) Remove socket bolt(29), and then screw two M8 eyebolts on front side of ring gear(1), lift up ring gear with crane, and remove O-ring(82) from housing(2).

※ It is difficult to separate them, because it is assembled by LOCTITE.  
In this case, if you can use wrench and pipe, it is easy to separate them.

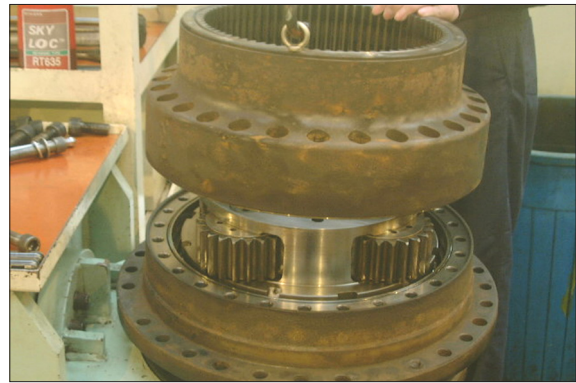

370078TM11

(11) Remove snap ring(37) and then remove pin 3(17) from shaft casing(272).

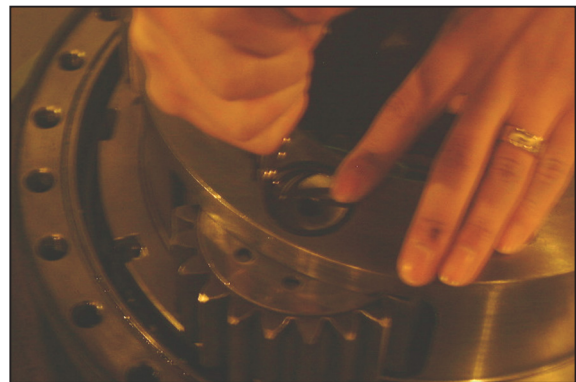

370078TM12

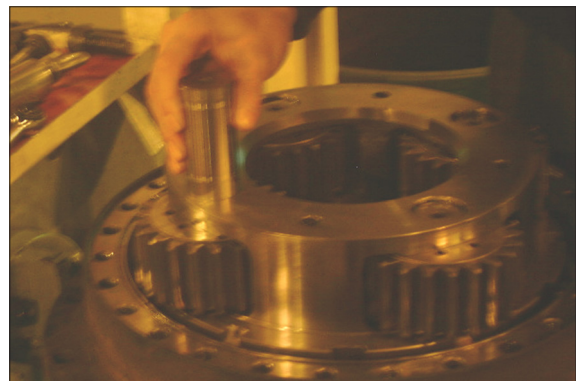

370078TM13

(12) Remove side plate(20), planetary gear 3(14), needle cage(23), floating bushing (25) from shaft casing(272).

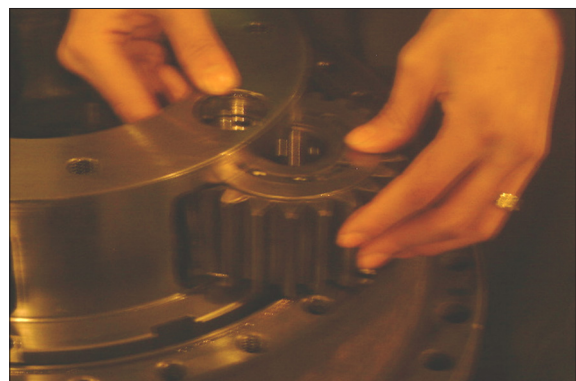

370078TM14

(13) Remove set screw(54) from nut ring(47), and then remove nut ring(47) from shaft casing(272).

- ※ When disassembling nut ring, remove dust, mud, etc. from set screw hole by blasting compressed air.  
And remove the nut ring by using the special tool for removing the nut ring.

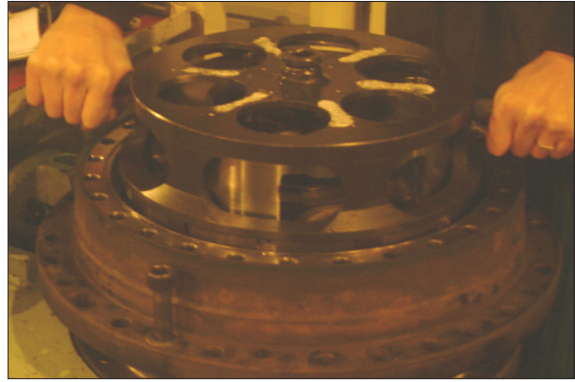

370078TM15

(14) Remove housing(2), angular bearing(33), floating seal(34) from shaft casing(272).

- ※ Screw two M16 eye bolts on front side of housing(2).  
Lift up housing(2) with crane.

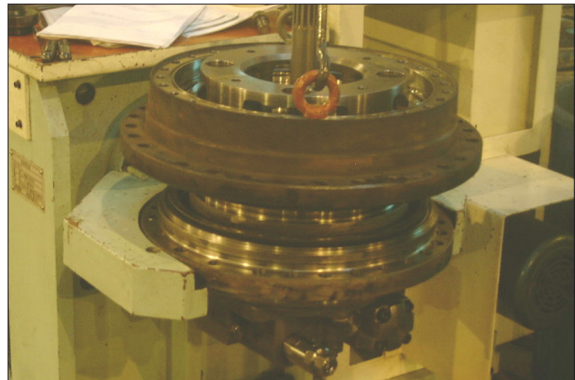

370078TM17

(15) Remove floating seal(34) from housing(2), paying attention to not damaging it.

- ※ Pay attention to O-ring and sheet faces.



370078TM18

(16) Remove floating seal(34) from casing (272), pay attention to not damaging it.

- ※ Pay attention to O-ring and sheet faces.

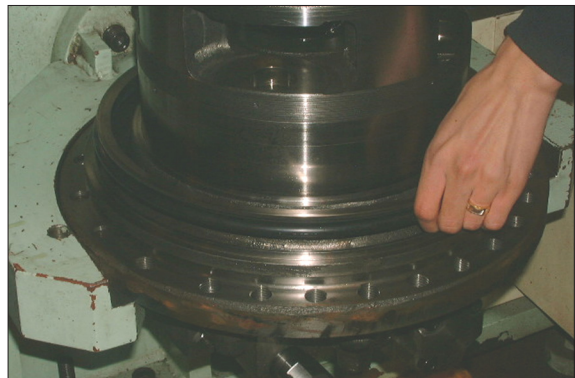

370078TM19



(17) Remove angular bearing(33) from housing(2).

※ Bearing should be renewed once it is removed.



370078TM20

### 3) DISASSEMBLY OF MOTOR

#### (1) Disassembling of motor main body

① Place hydraulic motor on bench with its output shaft down.

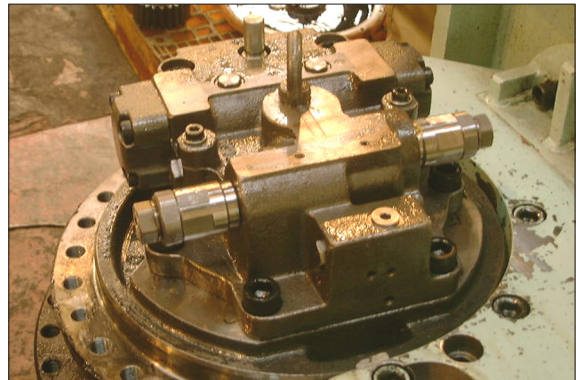

370078TM21

② Loosen relief valve(350), reducing valve (351), cover(352), plug, etc. They are fitted to valve casing(303).

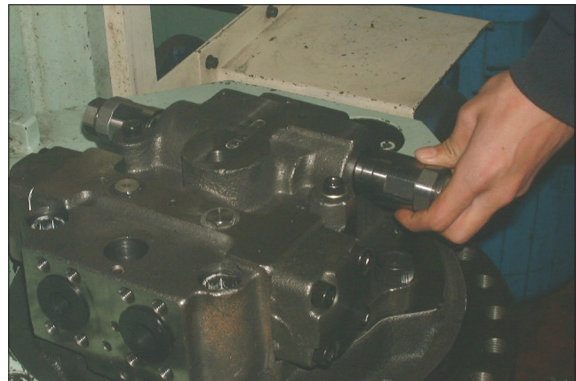

370078TM22

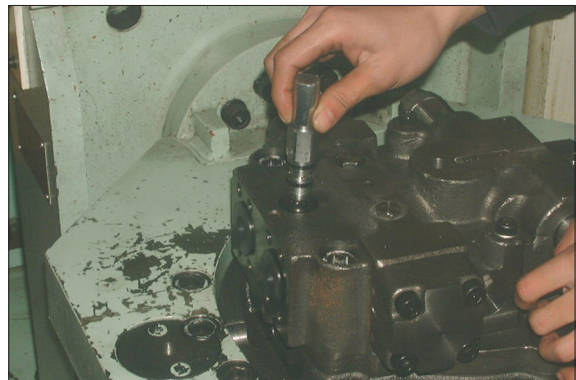

370078TM23



- ③ Remove plug(564) from valve casing (303). And then screw two M10×135 bolts on the holes of competent brake release. Sub assembly(valve casing & brake piston)

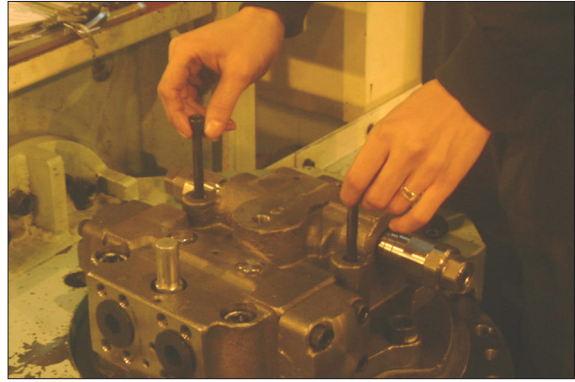

370078TM24

- ④ Remove socket bolts(401, 402) that assemble valve casing(303).

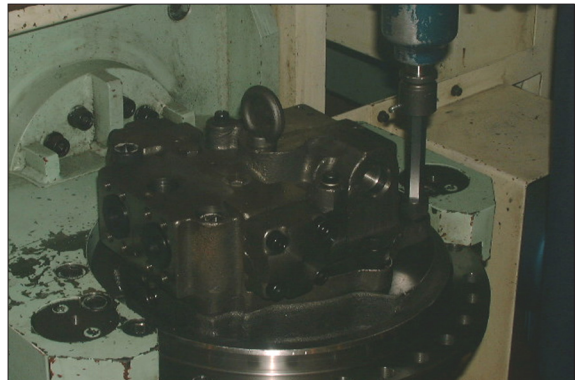

370078TM25

- ⑤ Remove the above socket bolt, and then separate valve casing sub-assembly and remove valve plate(131).

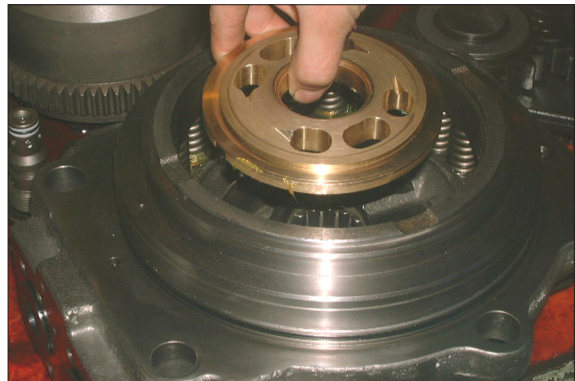

370078TM26

- ⑥ Pull out friction plate(742) and separation plate(741) from cylinder block(111).

- ※ In this case, motor should be located in horizontally.

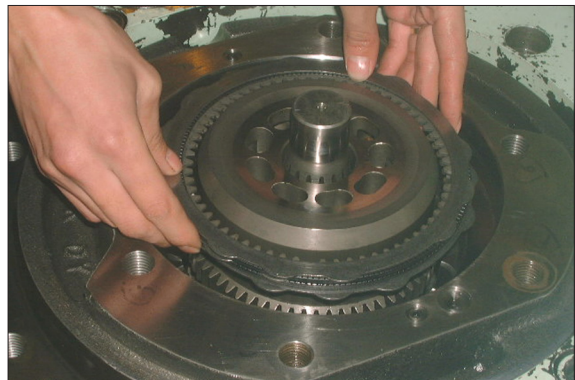

370078TM27

⑦ Pull out cylinder block and piston sub-assembly.

- ※ After placing the motor horizontally, take out cylinder block from casing.
- ※ Be careful not to damage the sliding parts of the cylinder block, spherical bushing and shoe.

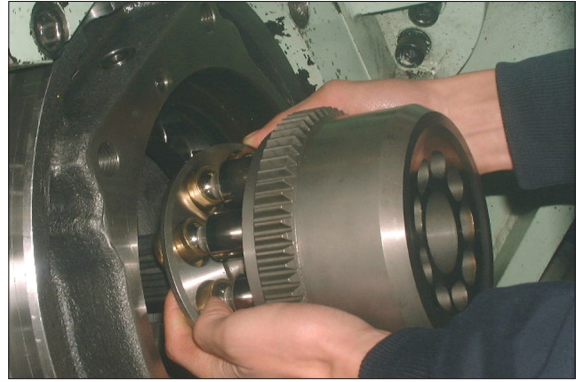

370078TM28

⑧ Remove swash plate(201).



370078TM29

⑨ Remove pivot ball(504) and tilting piston sub assembly.



370078TM30

⑩ Take out snap ring(435), and then hit front side end face of shaft(101) lightly with plastic hammer or so to remove from casing(272).

- ※ Do not remove cylindrical roller bearing (102) as far as it remains normal.

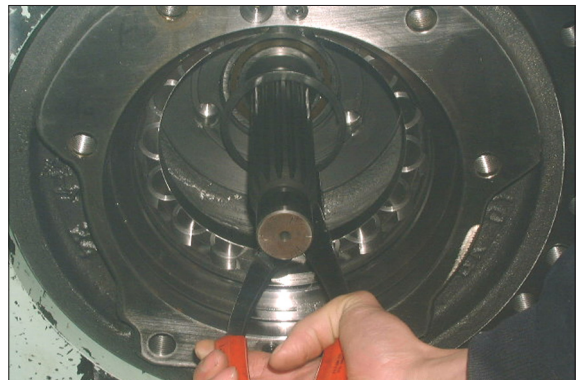

370078TM31



⑪ Take out oil seal(491) from shaft casing(272).

※ Do not reuse the disassembling oil seal(491).

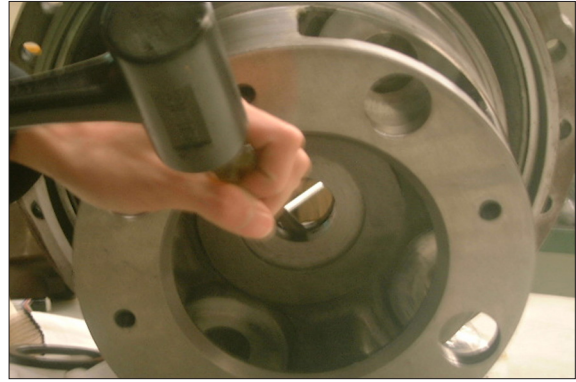

370078TM32

## (2) Disassembling of valve casing sub-assembly

① Remove two M10×135 bolts for compelling brake release. Disassemble brake piston from valve casing.

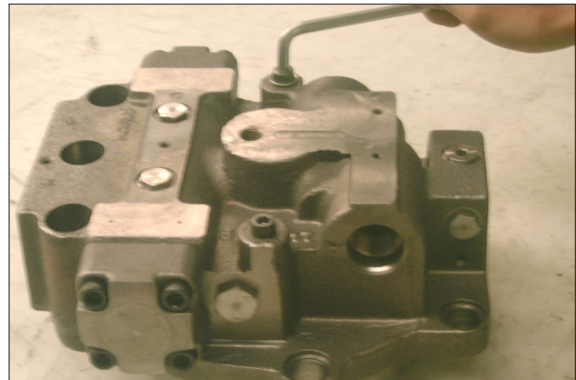

370078TM33

② Remove plug(571), tilting spring(533), and tilting spool(531) from valve casing.

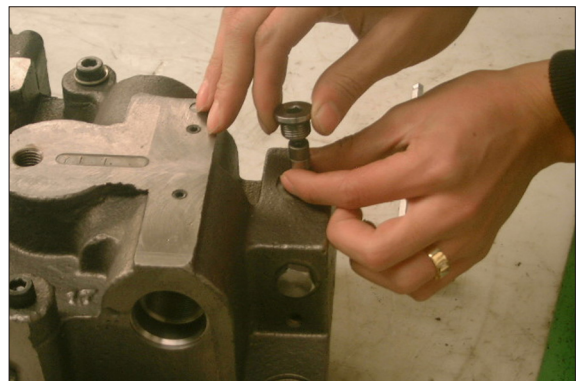

370078TM34

③ Remove socket bolts(366), counterbalance cover(364), and counterbalance spool assembly.

※ When any abnormality is found in counterbalance spool, counterbalance spring, etc. replace with the counterbalance spool sub assembly as a set.

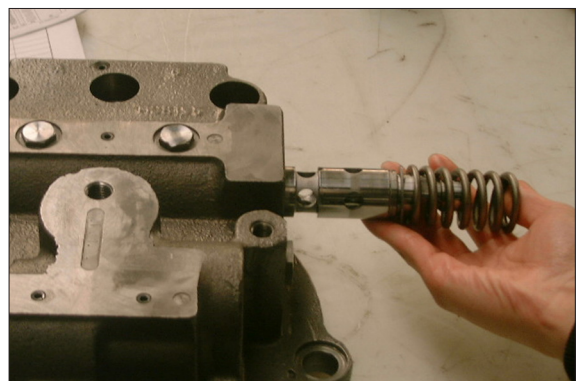

370078TM35

- ④ Remove plug(569), stopper(542), steel ball(543) and seat(541).

※ When no abnormality is found in displacement changeover, it is not necessary to overhaul it specifically.  
And don't remove needle bearing(103) as far as it remains normal.

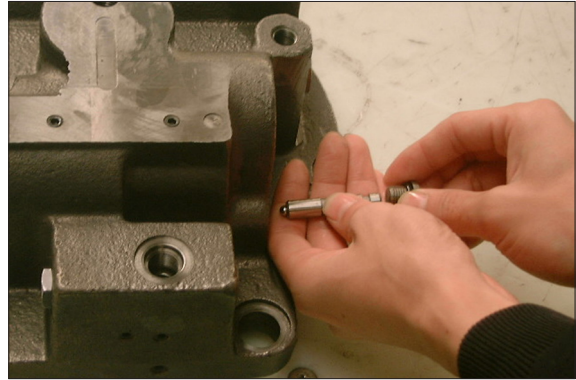

370078TM36

### (3) Disassembling of cylinder sub-assembly

- ① Pull out set plate(123), piston(121), and shoe(122) sub-assembly.



370078TM37

- ② Remove spherical bush(113) and cylinder spring(114).  
That is all of the disassembling work.  
The pins(451) force-fitted to the valve casing cannot be removed.



370078TM38

## 5. ASSEMBLING

### 1) GENERAL CAUTIONS

- (1) Clean each part fully with washing oil and dry it by blasting compressed air. It is better not to use waste cloths as much as possible.  
However, if they are to be used, use clean ones, and pay attention to not leaving lint and so on.  
Don't clean the friction plate with washing oil without fail.
- (2) Use the torque wrench in tightening fitting screws and plugs to their respective torque shown in page 8-75, 8-77.
- (3) When hammering is required, use the plastic hammer and try to hit parts lightly.
- (4) Similarly to the disassembling procedures, the numeral in parentheses following each part name indicates its item number shown in the attached **assembly drawings**.

### 2) ASSEMBLY OF MOTOR

#### (1) Assembling driving shaft sub-assembly

- ① Put roller bearing (102) on drive shaft (101), and assemble snap ring(107) by using the plier.
  - ※ Roller bearing is press fit by the heat to drive shaft.
  - ※ Pay attention to not damaging oil seal sliding area of driving shaft.
  - ※ Pay attention to not fitting snap ring the other way around.

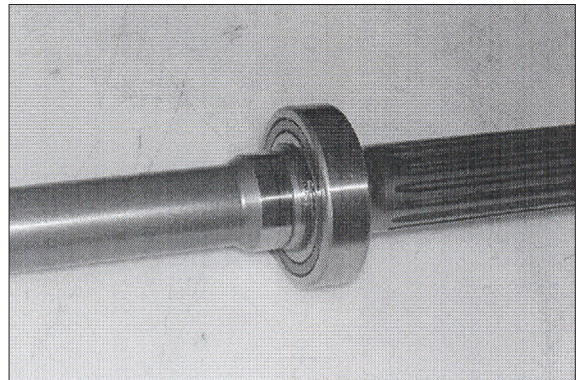

370078TM39

#### (2) Assembling of valve casing sub-assembly

- ① Tighten plugs(461, 564) into valve casing (303) with specified torque.
  - Plug(461) : 0.9kgf · m(6.5lbf · ft)
  - Plug(564) : 2.2kgf · m(15.9lbf · ft)



370078TM40

- ② Interference-fit pin(451).

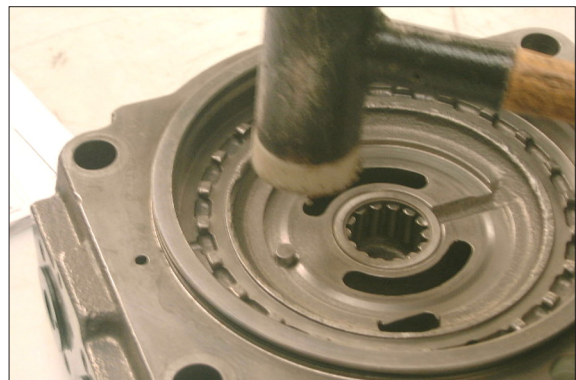

370078TM41



③ Interference-fit needle bearing(103).

- ※ It is necessary when needle bearing was disassembled from the valve casing.

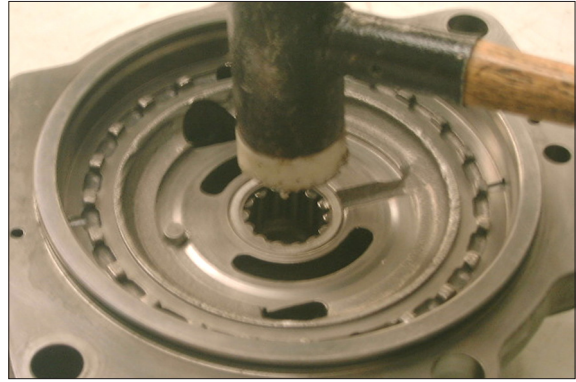

370078TM42

④ Assemble seat(541), steel ball(543), stopper(542) and RO plug(569) in the order named.

- Tightening torque : 3.7kgf · m(26.8lb · ft)

- ※ Pay attention to not assembling seat and stopper the other way around.

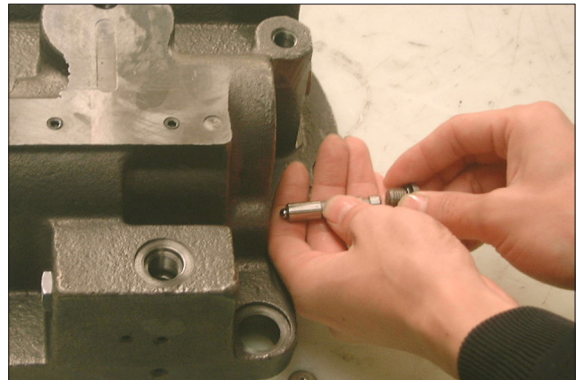

370078TM43

⑤ Assemble counterbalance spool(360), washer(361), spring(362) in the order named.

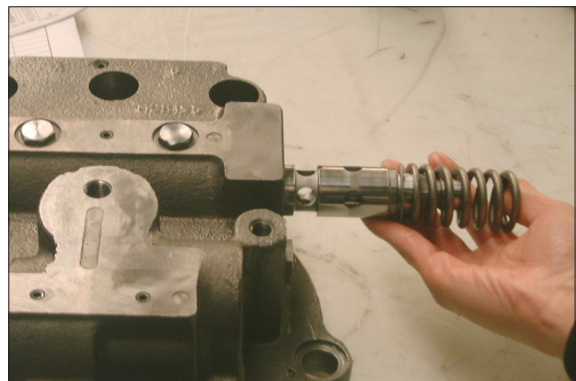

370078TM44

⑥ Fit counterbalance cover(364) by tightening socket bolt(366).

- Tightening torque : 10kgf · m(72.3lb · ft)

- ※ Confirm that O-ring(365) has been inserted in cover.

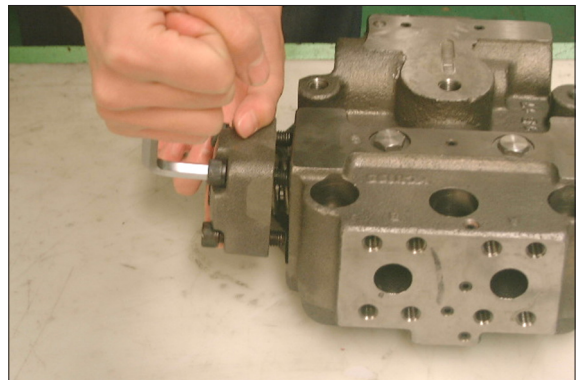

370078TM45

- ⑦ Assemble tilting spool(531), tilting spring(533) and plug(571) in the order named.

· Tightening torque : 7.5kgf · m(54.2lbf · ft)

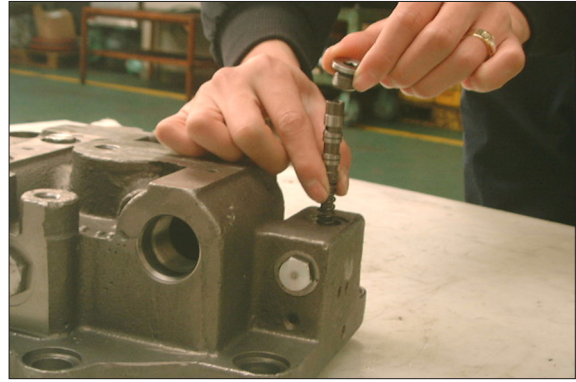

370078TM46

- ⑧ Assemble orifice(703) and tighten them into brake piston(702) to specified torque.

· Tightening torque : 0.35kgf · m(2.5lbf · ft)

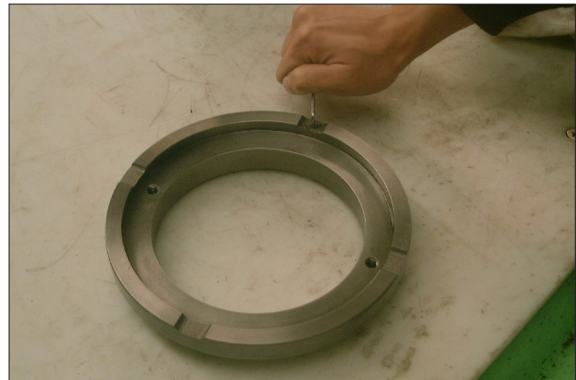

370078TM47

- ⑨ Assemble brake spring(705) in brake piston(702). And then screw two M10×135 bolts on the holes for complete brake release.

Sub-assembly(valve casing & brake piston)

※ After finishing assembly, two M10×135 bolts will be removed.

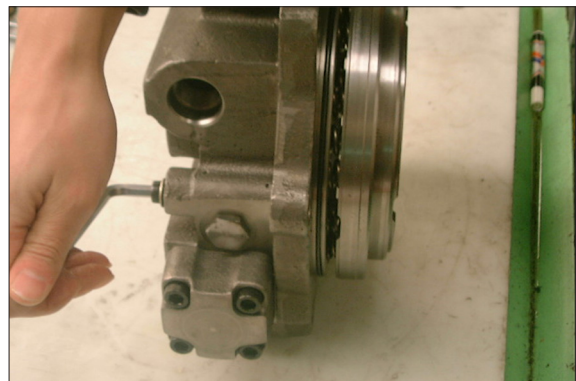

370078TM48

### (3) Assembling of cylinder sub-assembly

- ① Fit cylinder spring(114) and spherical bush(113) to cylinder block(111).

※ Match spline phase of cylinder block (111) to that of spherical bush.



370078TM49

- ② Put piston(121), shoe(122) sub-assembly in set plate(123) and then assemble them to cylinder block(111).



370078TM50

#### (4) Assembling of motor main body

- ① Tighten plug(461) and orifice(545, 546) into shaft casing(272) to specified torque.
- Plug(461) : 0.9kgf · m(6.5lbf · ft)
  - Plug(545, 546) : 0.7kgf · m(5.1lbf · ft)



370078TM51

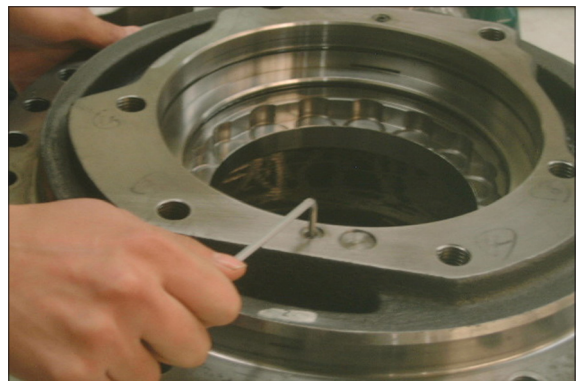

370078TM51A

- ② Interference-fit oil seal(491) into shaft casing(272) by special tool.



370078TM52



③ Interference-fit the shaft sub-assembly.  
And then assemble snap ring(435).

※ Interference-fit outer race of cylindrical roller bearing(102) by hitting lightly with hammer, utilizing key.

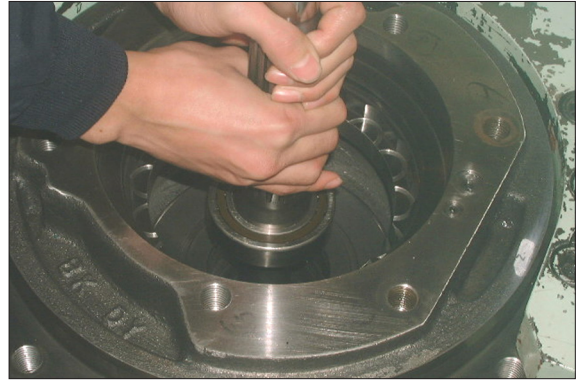

370078TM53

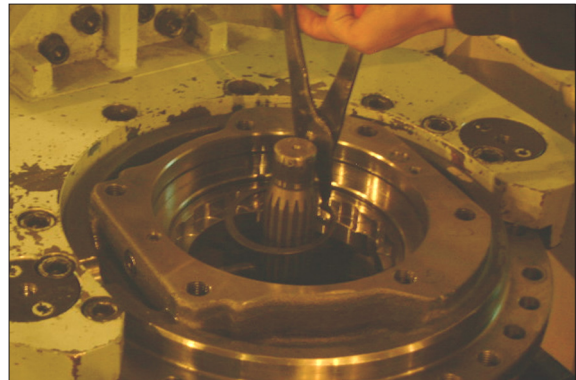

370078TM54A

④ Assemble tilting piston sub-assembly and  
pivot ball(504) into shaft casing(272).



370078TM54

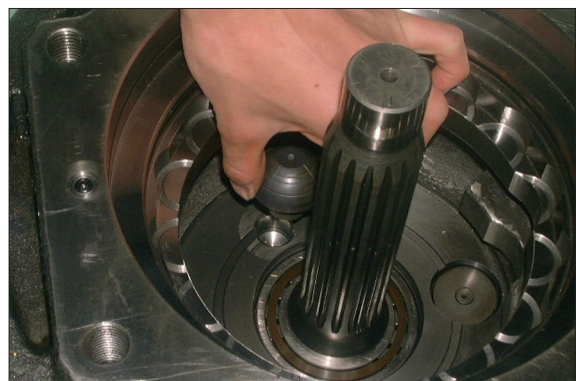

370078TM54A

⑤ Assemble swash plate(201) onto pivot ball(504).

- ※ Apply grease on sliding area of swash plate rear surface.
- ※ Confirm with finger tips of both hands if swash plate moves smoothly.



370078TM55

⑥ Change position of shaft casing(272) from vertical one to horizontal one. And then mount cylinder block sub-assembly.

- ※ Pay attention to not dropping swash plate.

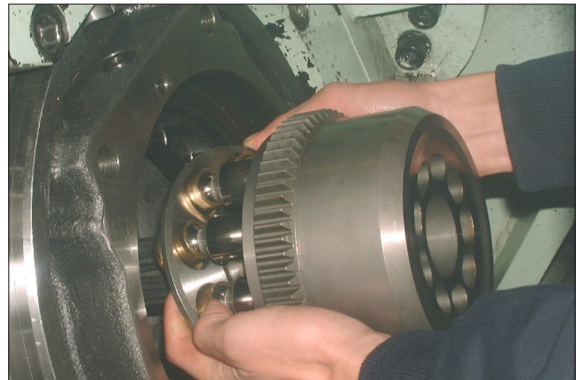

370078TM56

⑦ Change position of shaft casing(272) from horizontal one to vertical one.



370078TM57

⑧ Fit separation plate(741) and friction plate(742) into cylinder block(111).

- ※ Mate hole of separation plate each other.

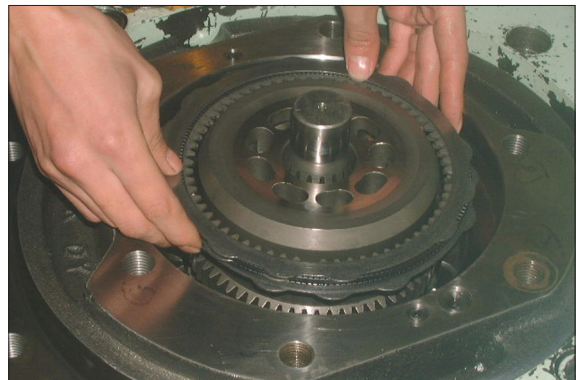

370078TM27



⑨ Assemble O-ring(707, 708) into shaft casing(272).

- ※ Do not reuse the disassembling O-ring (707, 708).
- ※ Coat the O-ring with grease.  
(O-ring can be protected by grease)

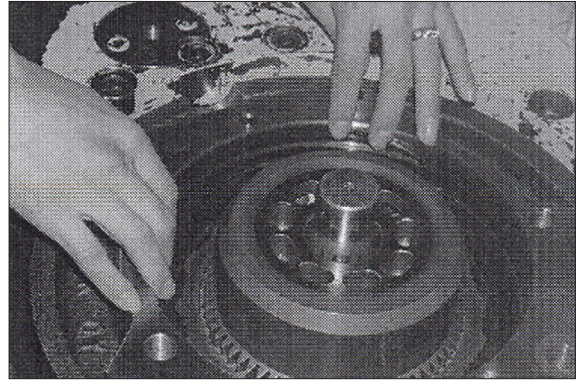

370078TM59

⑩ Fit valve plate(131) to valve casing(303) sub-assembly. Assemble them to casing, and then tighten them with socket bolt(401, 402).

- Socket bolt(401, 402) Tightening torque : 44kgf · m(318lbf · ft)

- ※ Apply grease on valve plate rear surface and pay attention to not dropping valve plate.
- ※ Use guide bolt.
- ※ Apply grease on roller of needle bearing and pay attention to easy to assemble with driving shaft.
- ※ Use crane in assembling valve casing to shaft casing.

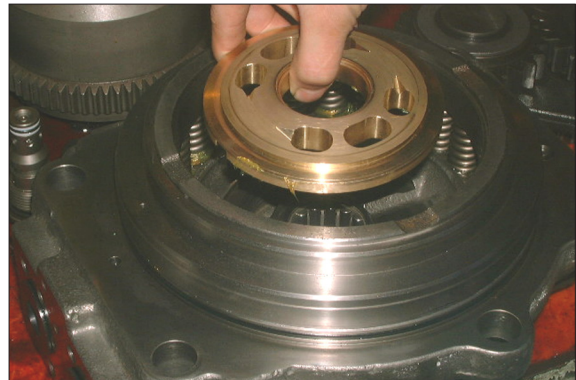

370078TM60

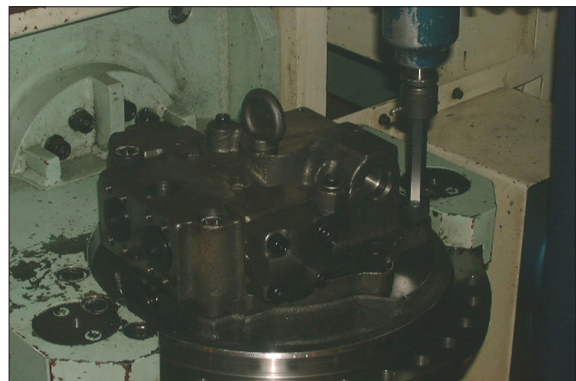

370078TM60A

⑪ Tighten to specified torque plugs, relief valve(350), reducing valve(351), etc. fitted to valve casing sub-assembly.

- Tightening torque :
  - Relief valve(350) : 18kgf · m(130lbf · ft)
  - Reducing valve(351) : 4.5kgf · m(32.5lbf · ft)

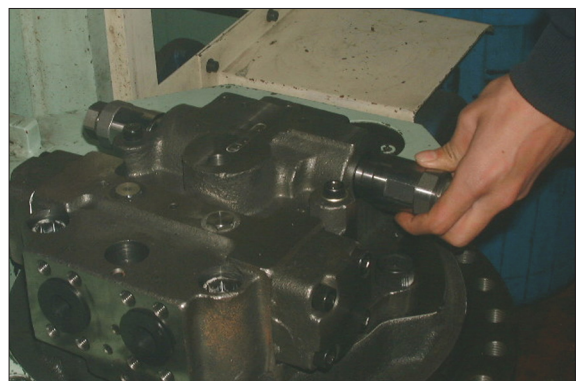

370078TM61

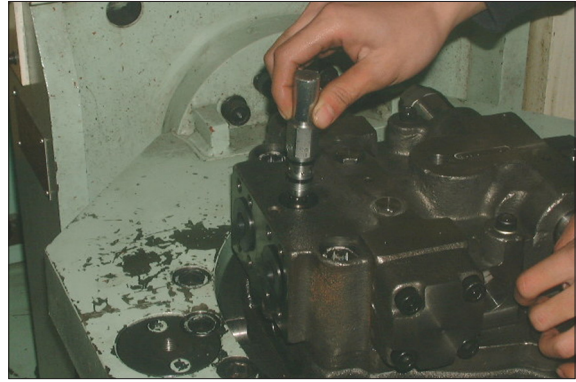

370078TM61A

⑫ Mount cover(352).

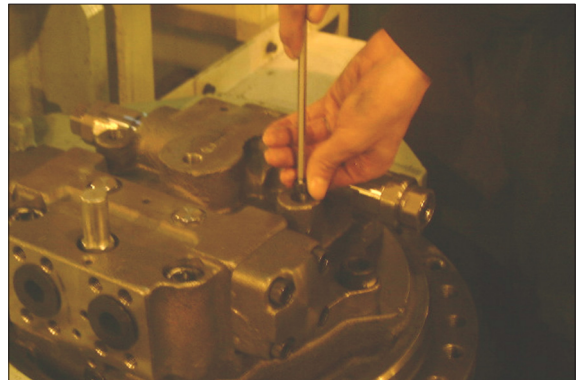

370078TM63

⑬ Disassemble two M10×135 bolts on the holes for complete brake release. And then assemble plug(564).  
· Tightening torque : 2.2kgf · m(15.9lbf · ft)

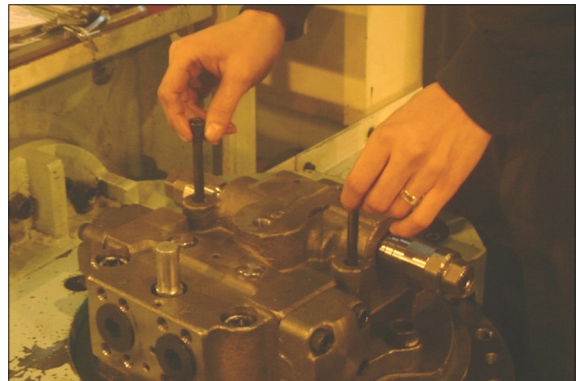

370078TM24

### 3) ASSEMBLY OF REDUCTION GEAR

(1) Place housing(2) with its front side up, and fit angular bearings(33) with their back faces mated.

- ※ Fit angular bearings one by one with press or key hammer.
- ※ When housing is to be reused, remove screw lock of its tapped holes with M16 tap.

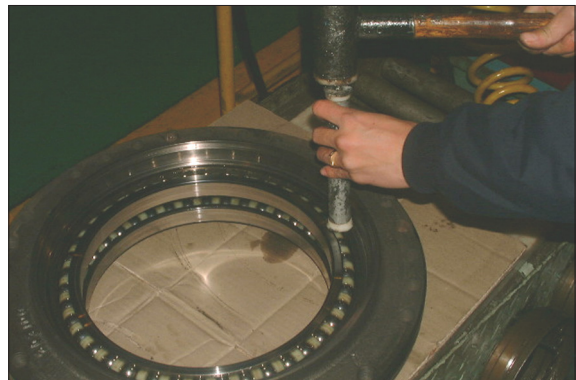

370078TM64



(2) Fit O-ring to floating seal(34) without twisting it, and then to housing(2).

- ※ Apply grease to O-ring thinly.
- ※ Do not reuse the disassembling O-ring.

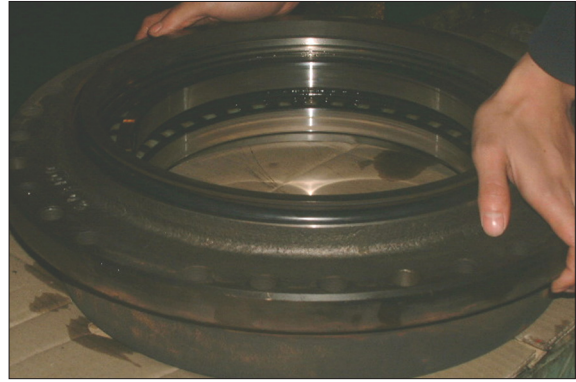

370078TM65

(3) Similarly, fit floating seal to shaft casing(272) of hydraulic motor.

- ※ Do not reuse the disassembling O-ring.

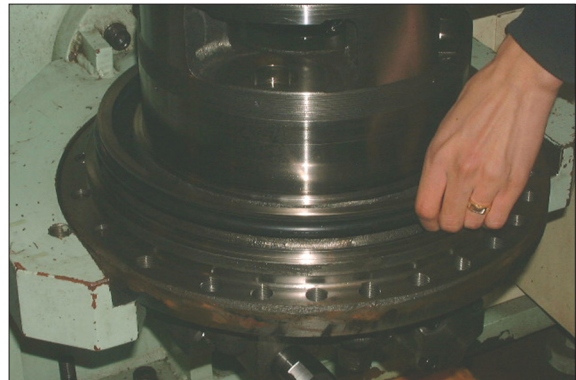

370078TM66

(4) Lift up housing sub-assembly with its floating seal side down, and put inner diameter of angular bearing on outer diameter of shaft casing.

- ※ Pay attention to not damaging sliding faces of floating seal.

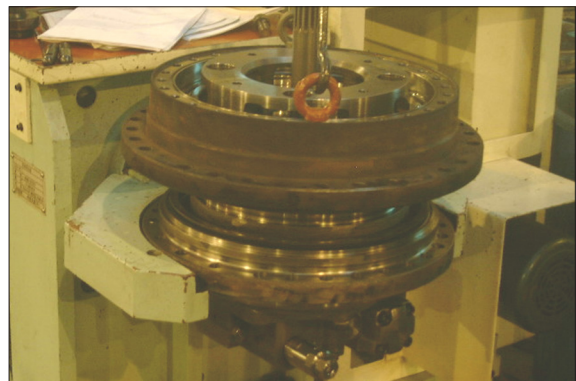

370078TM67

(5) Assemble shim(35) to nut ring(47).

- ※ Apply grease between shim and nut ring.



370078TM68

(6) Insert nut ring assembled shim to shaft casing, and then tighten it to specified torque, utilizing special tool.

※ After tighten it to maximum torque and then disassemble, and then tighten it to specified torque.

· Tightening torque : 60kgf · m(434lbf · ft)

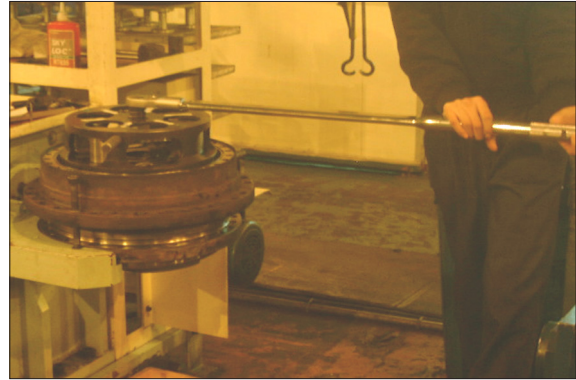

370078TM70

(7) After assemble set screw(54) affixed LOCTITE, and punch at hole to lock it. Pay attention to not be lifted nut ring(47).

※ Screw the set screw, until upper side of set screw is lower than tilting side of nut ring.

· Loctite specifications : Three bond 1373B

· Tightening torque : 1kgf · m(7.2lbf · ft)



370078TM71

(8) Assemble thrust ring(27) into shaft casing(272).

※ Pay attention to not assembling thrust ring(27) the other way around. (Oil groove is located upside.)



370078TM72

(9) Put needle cage(23) into inside of planetary gears 3(14), and insert them into shaft casing, holding them between side plates(20).

※ Mate pin hole of shaft casing with center of planetary gear.

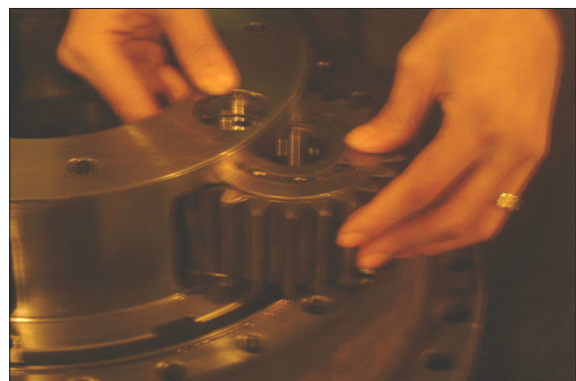

370078TM73

(10) Insert pin 3(17) into shaft casing, and then assemble snap ring(37).

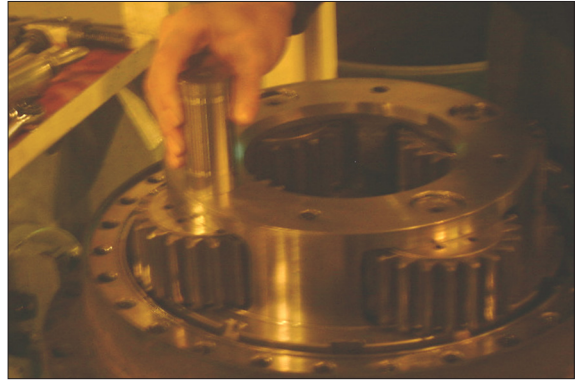

370078TM74

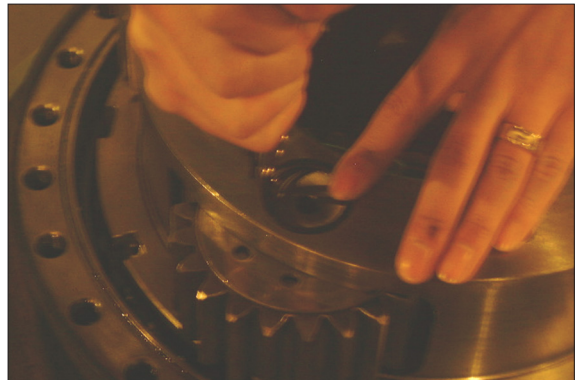

370078TM74A

(11) Assemble O-ring(82) to housing(2), and then assemble ring gear(1).  
Pay attention to its meshing planetary gear 3(14) and ring gear(1), utilizing crane.

- ※ Applying grease to O-ring thinly.
- ※ Do not reuse the disassembling O-ring.



370078TM75

(12) Assemble ring gear(1) and housing(29).  
(Screw socket bolt(29), and tighten it to specified torque, with torque wrench.)  
· Tightening torque : 30kgf · m(217lb · ft)  
· Loctite specifications : #636



370078TM76



**(13) Assembling carrier 2 sub-assembly**

- ① Assemble carrier 2(6) to sun gear 3(11), and fit clip(46).
- ② Place carrier 2 with sun gear 3 up.

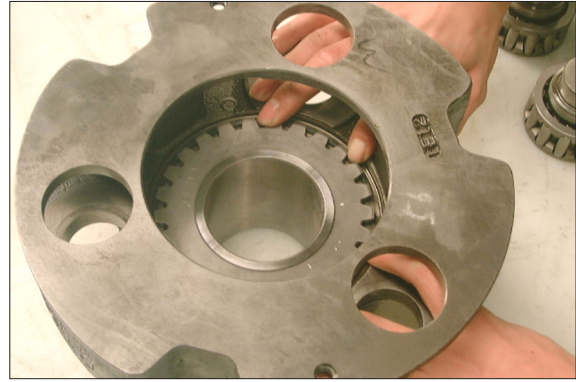

370078TM77

- ③ Put needle cage(22) into inside of planetary gear 2(13), and insert them into carrier 2, holding them between side plates(19).

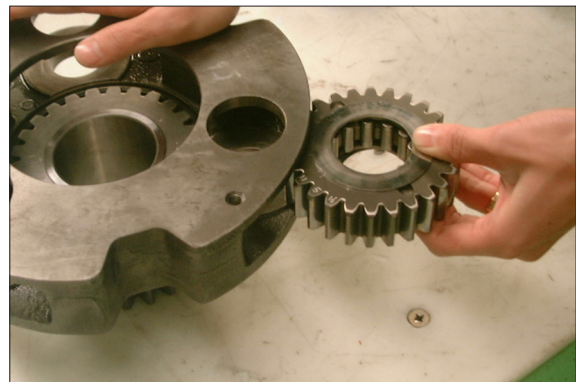

370078TM78

- ④ Insert pins 2(16) into carrier 2.

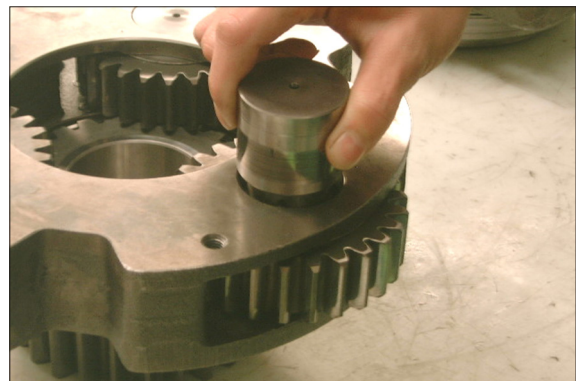

370078TM78A

- ⑤ Insert spring pin(36) into pin holes of carrier 2 and pin 2, and punch at two points as figure to lock it.

※ Mate pin hole of carrier 2 with center of planetary gear.

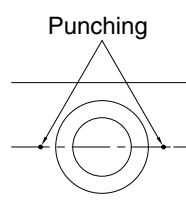

370078TM79



- (14) Screw two M10 eyebolts into carrier 2 sub-assembly, and assemble it with crane, paying attention to its meshing with planetary gear 2 and ring gear.

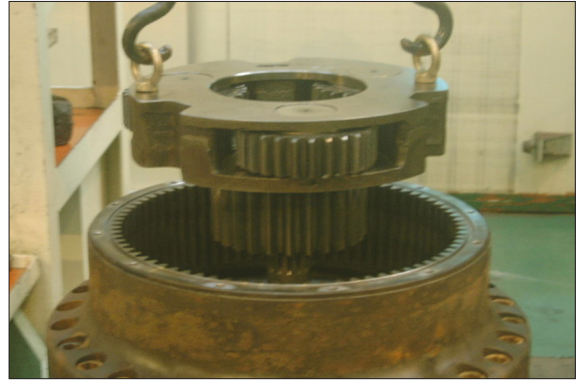

370078TM80

**(15) Assembling of carrier 1 sub-assembly**

- ① Interference-fit inner ring(24) to carrier 1(5).  
※ Inner ring is press-fit by the heat to carrier 1(5).

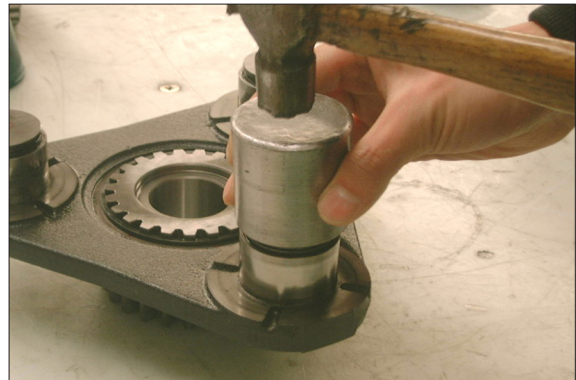

370078TM81

- ② Assemble carrier 1(5) to sun gear 2(10), and fit clip(45).



370078TM82

- ③ Assemble thrust ring(26) to sun gear 2(10).

- ※ Pay attention to not assembling thrust ring(26) the other way around.  
(Oil groove is located upside.)



370078TM83

- ④ Put needle cage(21) into inside of planetary gear 1(12), and assemble them, holding them between side plates (18). Then fit snap ring(44) on them.

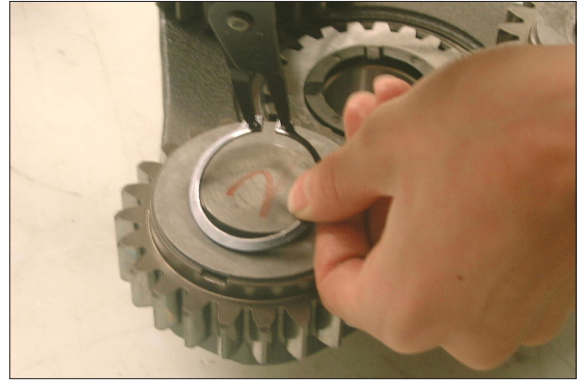

370078TM84

- (16) Assemble carrier 1(5) sub-assembly to ring gear(1).  
Paying attention to its meshing with carrier 1 sub-assembly and ring gear(1).



370078TM85

- (17) Assemble sun gear 1(9) to drive shaft (101) paying attention to its meshing with sun gear and drive shaft(101).

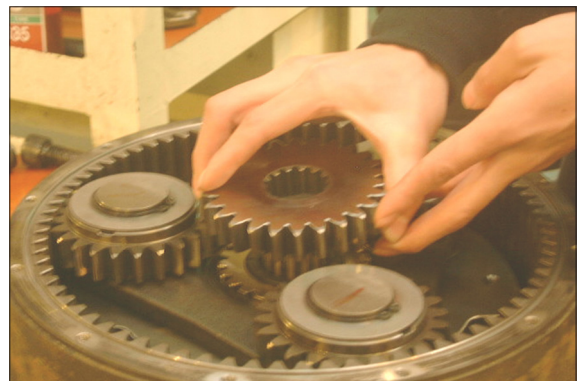

- (18) Measure height "A" from sun gear 1 end face to ring gear(1) mating face with straight edge and depth gage.



370078TM87

- (19) Measure height "B" from side cover(4) mating face to center hold bottom with straight edge and depth gage.

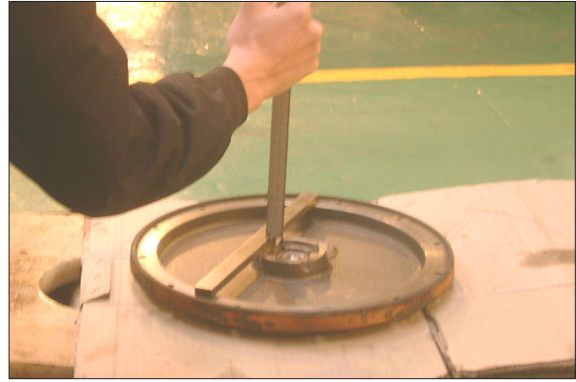

370078TM88

- (20) Obtain optimum thickness with the following formula.

$$1.5 \sim 2.0 = (B+A)$$

- (Thickness of thrust ring + thickness of washer)

- ※ Keep axial clearance between sun gear and washer 1.5~2.0mm.

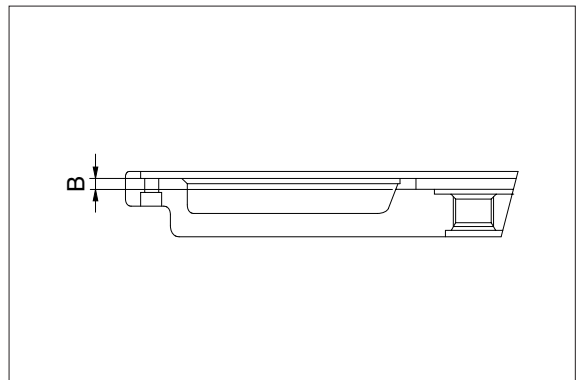

370078TM89

- (21) Place washer(53) of above-selected thickness and thrust ring(26) to center of side cover(4).

- ※ Pay attention to not assembling thrust ring (26) the other way around and punch it (Oil groove is located upside)



370078TM90

- (22) Assemble O-ring(81) into ring gear.

And decrease and dry mating faces of side cover & ring gear. Then lift side cover(4) up, and place it on ring gear.

And tighten socket bolt(30) to specified torque to fix side cover.

- Tightening torque : 3.5kgf · m(25.3lbf · ft)



370078TM91



(23) Tighten plug(32) to specified torque at side cover(4).

- Tightening torque : 11.0kgf · m(79.6lbf · ft)

That is all of the assembling work. After fitting the motor this reduction gear, supply oil until overflows from the level gauge.



370078TM92

#### 4) CHECKING FACTS AFTER ASSEMBLY

##### (1) Air test of reduction gear

Disassemble plug(32) of reduction gear part.

When compressed air(0.3kgf/cm<sup>2</sup>) is inserted that in water during the 2 minutes, it should be not happened air bubble.

- Gear oil : 5.5 liter (SAE 85W-140, API GL-5 or better)

##### (2) Air test of hydraulic motor

One port should be opened, the others port should be closed.

When compressed air(3kgf/cm<sup>2</sup>) is inserted opened port in water during the 2 minutes, it should be not happened air bubble.

- Working fluid : 1.5 liter