

GROUP 5 UNDERCARRIAGE

ADJUST COMPONENT

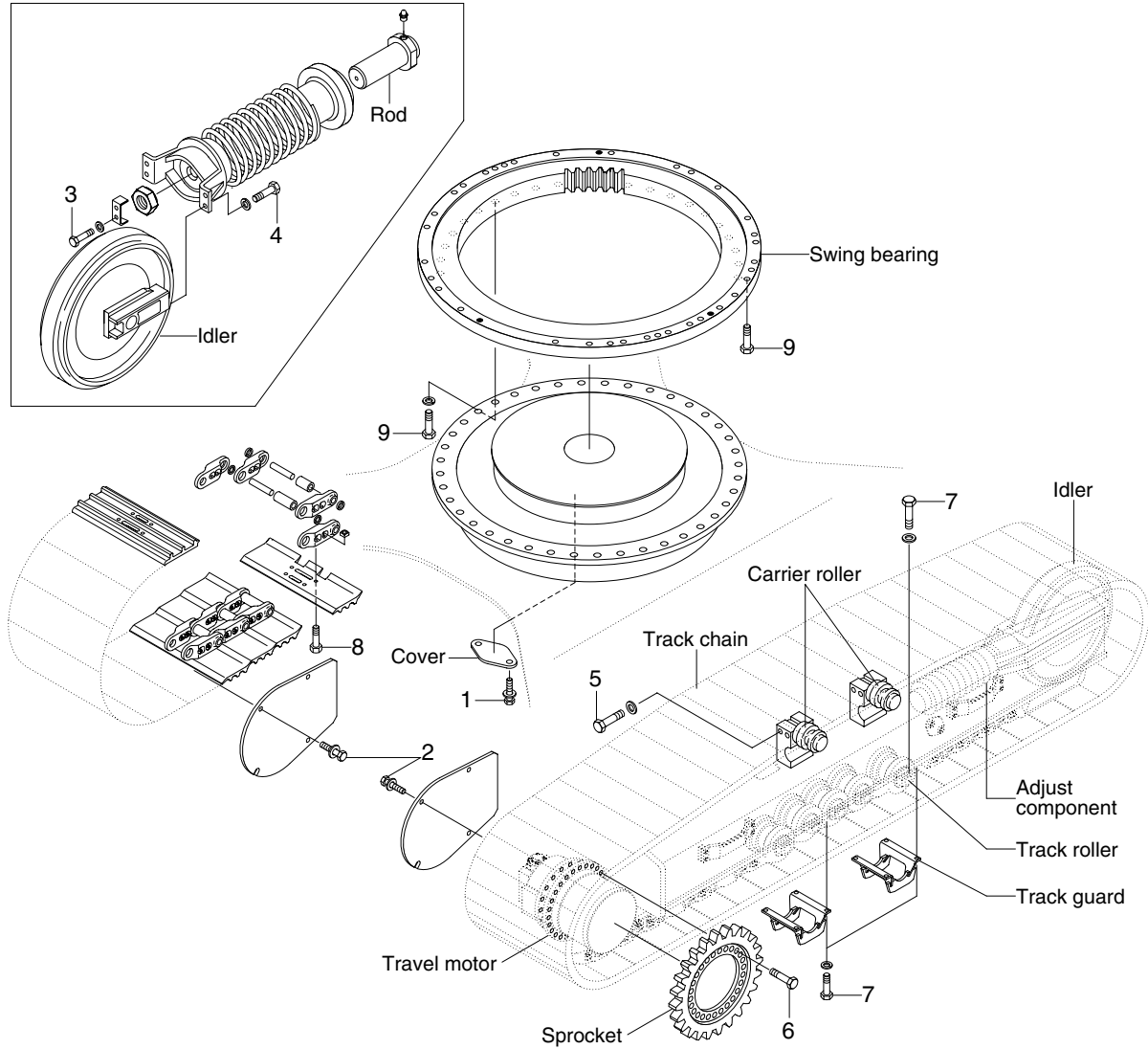

36079CM08

· Tightening torque

Item	Size	kgf · m	lbf · ft
1	M10×1.5	6.9±1.4	49.9±10.1
2	M12×1.75	12.8±3.0	92.6±21.7
3	M12×1.25	13.3±2.7	96.2±19.5
4	M16×2.0	26.6±3.2	214±23.1
5	M16×2.0	29.7±4.0	215±28.9

Item	Size	kgf · m	lbf · ft
6	M20×2.5	51±4.0	369±28.9
7	M22×2.5	77.4±11	560±79.6
8	3/4-16UNF	78±3.0	564±21.7
9	M24×3.0	97.8±10	707±72.3
-	-	-	-