

GROUP 5 UNDERCARRIAGE

UNDERCARRIAGE MOUNTING

ADJUST COMPONENT

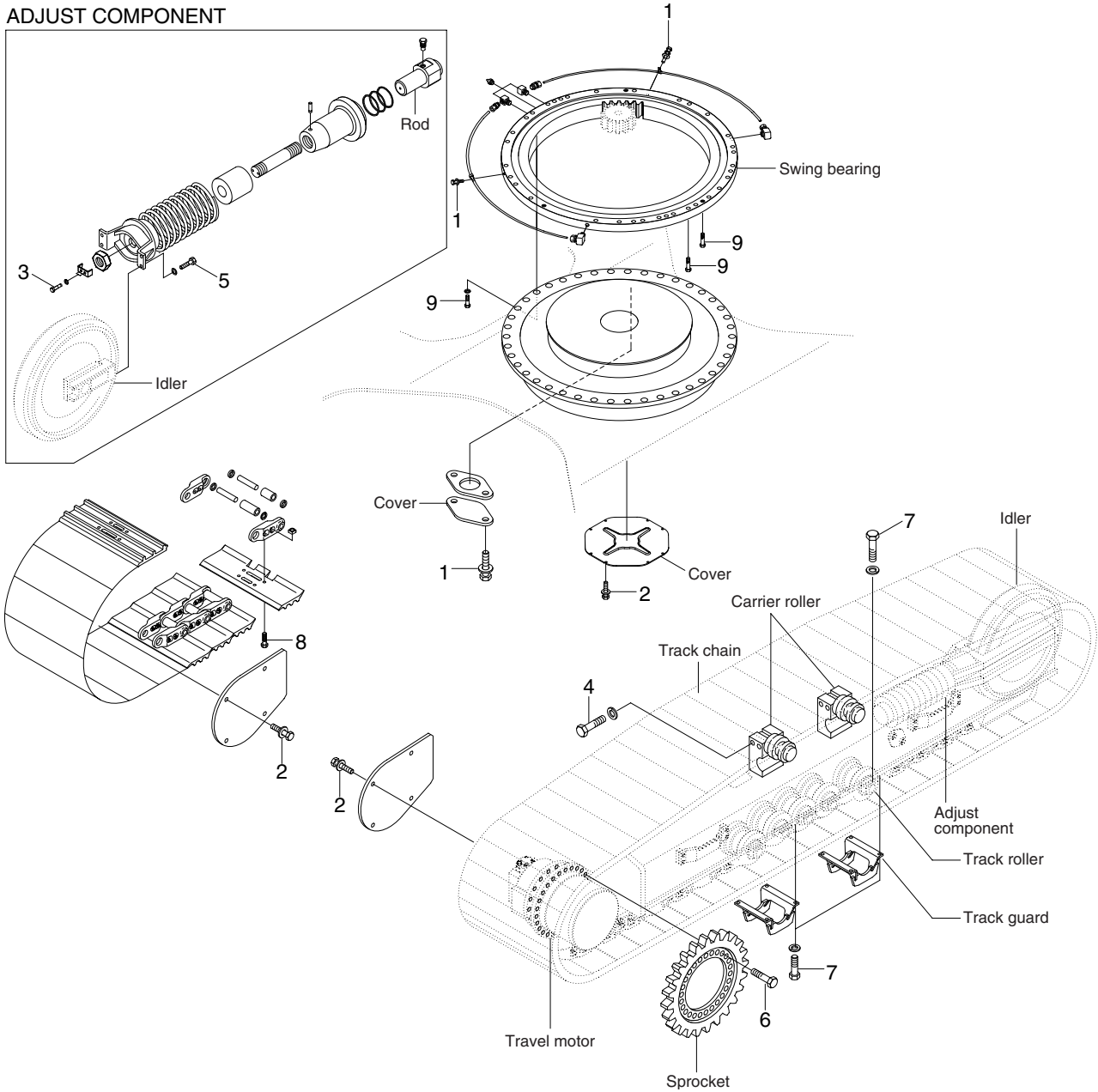

3309S9CM08

· Tightening torque

Item	Size	kgf · m	lbf · ft
1	M10×1.5	6.9±1.4	49.9±10.1
2	M12×1.75	12.8±3.0	92.6±21.7
3	M12×1.75	15±0.5	108±3.6
4	M16×2.0	29.7±3.0	215±21.7

Item	Size	kgf · m	lbf · ft
5	M16×2.0	29.7±4.5	215±32.5
6	M20×2.5	57.9±6.0	419±43.4
7	M22×1.5	115±5.0	831±36
8	M24×3.0	100±10	723±72.3

UNDERCARRIAGE MOUNTING (HIGH WALKER)

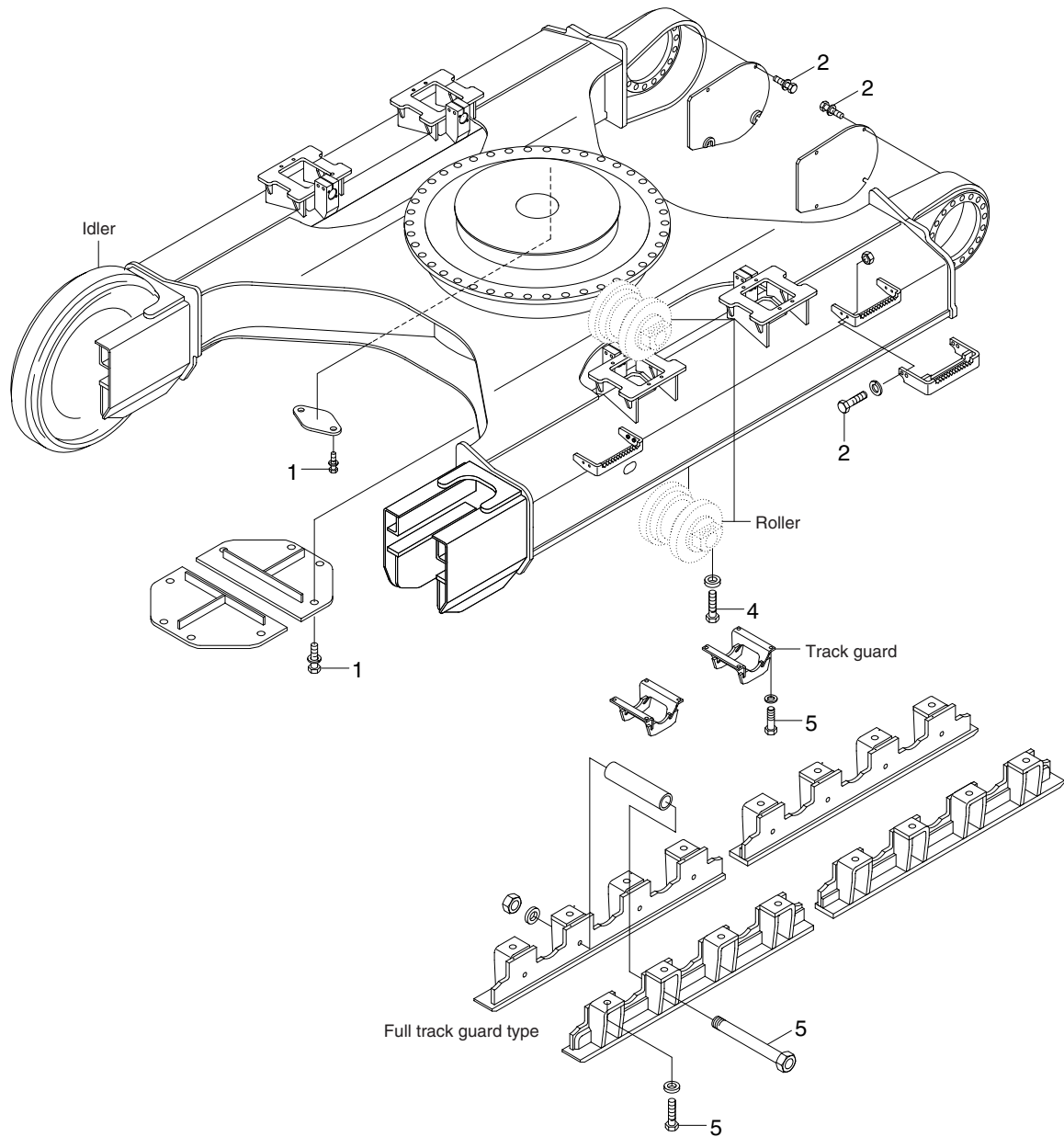

3309S9CM09

· Tightening torque

Item	Size	kgf · m	lbf · ft
1	M10×1.5	6.9±1.4	49.9±10.1
2	M12×1.75	12.2±1.3	88.2±9.4
3	M20×2.5	51±4.0	369±28.9

Item	Size	kgf · m	lbf · ft
4	M20×2.5	57.9±8.6	419±62.2
5	M24×3.0	100±15	723±108
6	-	-	-