

GROUP 6 TRAVEL DEVICE (TYPE 2, 3)

1. REMOVAL AND INSTALL

1) REMOVAL

- (1) Swing the work equipment 90° and lower it completely to the ground.
- (2) Operate the control levers and pedals several times to release the remaining pressure in the hydraulic piping.
- (3) Loosen the breather slowly to release the pressure inside the hydraulic tank.

▲ Escaping fluid under pressure can penetrate the skin causing serious injury.

※ When pipes and hoses are disconnected, the oil inside the piping will flow out, so catch it in oil pan.

- (4) Remove the track shoe assembly.
For details, see **removal of track shoe assembly**.
- (5) Remove the cover.
- (6) Remove the hoses.
※ Fit blind plugs to the disconnected hoses.
- (7) Remove the bolts and the sprocket.
- (8) Sling travel device assembly (1).
- (9) Remove the mounting bolts (2), then remove the travel device assembly.
· Weight : 430 kg (950 lb)

2) INSTALL

- (1) Carry out installation in the reverse order to removal.
- (2) Bleed the air from the travel motor.
 - ① Remove the air vent plug.
 - ② Pour in hydraulic oil until it overflows from the port.
 - ③ Tighten plug lightly.
 - ④ Start the engine, run at low idling, and check oil come out from plug.
 - ⑤ Tighten plug fully.
- (3) Confirm the hydraulic oil level and check the hydraulic oil leak or not.

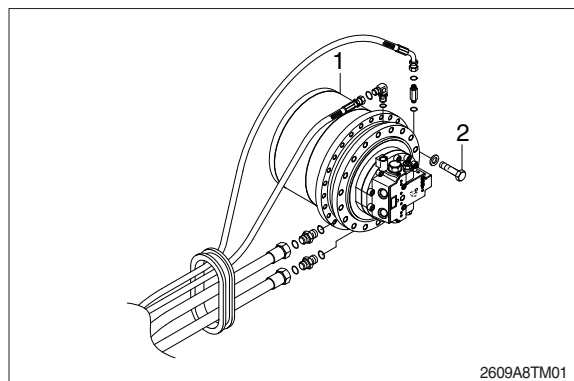

2. SPECIFICATION

1) TRAVEL MOTOR

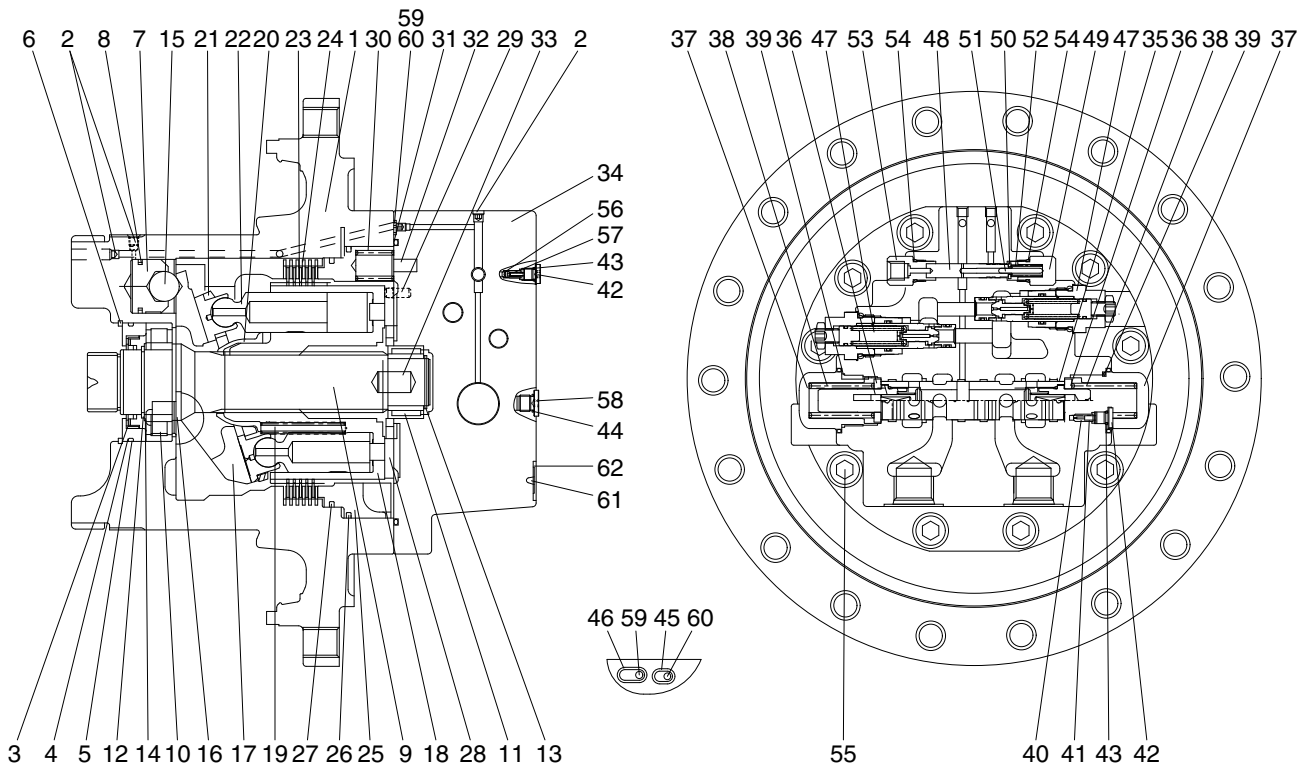

2609A2TM02

1	Casing	22	Piston assy	43	O-ring
2	Plug	23	Friction plate	44	O-ring
3	Oil seal	24	Separated plate	45	O-ring
4	Thrust block	25	Parking piston	46	O-ring
5	O-ring	26	D-ring	47	Relief valve
6	Snap ring	27	D-ring	48	Spool
7	Piston	28	Valve plate	49	Plug
8	Piston seal	29	Parallel pin	50	Spring seat
9	Shaft	30	Spring	51	Parallel pin
10	Cylinder roller bearing	31	O-ring	52	Spring
11	Needle bearing	32	Spring pin	53	Connector
12	Snap ring	33	Parallel pin	54	O-ring
13	Snap ring	34	Rear cover	55	Hexagon socket head bolt
14	Thrust plate	35	Main spool assy	56	Check valve
15	Steel ball	36	Spring seat	57	Spring
16	Pivot	37	Plug	58	Plug
17	Swash plate	38	Spring	59	Restrictor
18	Cylinder block	39	O-ring	60	Restrictor
19	Spring	40	Restrictor	61	Name plate
20	Ball guide	41	Spring	62	Rivet
21	Retainer plate	42	Plug		

2) TOOL AND TIGHTENING TORQUE

(1) Tools

Name of tools	B-size	Name of part applied
Hexagonal L-Wrench	4	Plug (2), Orifice screw (3, 4, 38)
	8	Hex socket bolt (50), Lock screw (62, 72), Plug (65)
	10	Hex socket bolt (49)
	46	Hex (57)
Socket wrench/ spanner	19	Hp plug (54)
	24	Hex nut (63)
	27	Hp plug (56)
Snap-ring plier (for holes, axis)		Ring stop (14), Ring lock (74)
Solder hammer		Needle bearing (34), Pin (5, 6, 36)
Torque wrench		Size : 500, 3000
Jig for assembling oil seal		Oil seal (73)
Induction heating apparatus for bearing		Roller bearing (13)

(2) Tightening torque

NO.	Part name	Standard	Size	Torque	
				kgf · m	lbf · ft
2	Plug	NPTF 1/16	4	0.9±0.2	6.51±1.45
3, 4, 38	Orifice screw	NPTF 1/16	4	0.7	5.06
49	Hex socket bolt	M12	10	10	72.33
50	Hex socket bolt	M10	8	6.7	48.46
54	Plug	PF 1/4	19	3.7	26.76
56	Plug	PF 1/2	27	11	79.56
57	Relief valve	HEX 27	1 5/16	34±3.4	246±24.6
63	Nut	M16	24	24	173.59
65	Plug	PF 3/8	8	7.5	54.25
70, 72	Hex socket bolt	M16	14	24	173.59
71	Hex socket bolt	M16	14	24	173.59

3. DISASSEMBLING

1) GENERAL INSTRUCTIONS

- ▲ Combustibles such as white kerosene are used for washing parts.**
These combustibles are easily ignited, and could result in fire or injury.
Be very careful when using.
 - ▲ Internal parts are coated with hydraulic fluid during disassembling and are slippery.**
If a part slips out of your hand and falls, it could result in bodily injury or could damage the park.
Be very careful when handling.
- (1) Generally, hydraulic equipment is precisely manufactured and clearances between each parts are very narrow. Therefore, disassembling and assembling works should be performed on the clean place where dusts hardly gather. Tools and kerosene to wash parts should also be clean and handled with great care.
 - (2) When motor is removed from the host machine, wash around the ports sufficiently and put the plugs so that no dust and/or water may invade. Take off these plugs just before the piping works when re-attach it to the host machine.
 - (3) Before disassembling, review the sectional drawing and prepare the required parts, depending on the purpose and the range of disassembling.
Seals, O-rings, etc., if once disassembled, are not reusable.
There are some parts that should be replaced as a subassembly.
Consult with the parts manual in advance.
 - (4) The piston can be inserted to whichever cylinder block for the initial assembling.
However, their combination should not be changed if they are once used. To reuse them, put the matching mark on both pistons and cylinder block before disassembling.
- ▲ Take great care not to pinch your hand between parts while disassembling nor let fall parts on your foot while lifting them.**

2) DISASSEMBLING TRAVEL MOTOR

- (1) Disassemble main spool cover (36) into rear cover (34) using spanner and torque wrench and then disassemble spring (37), main spool assy (35).

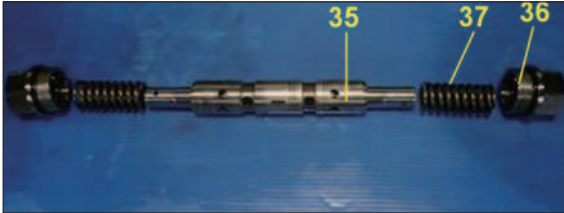

2609A8TM02

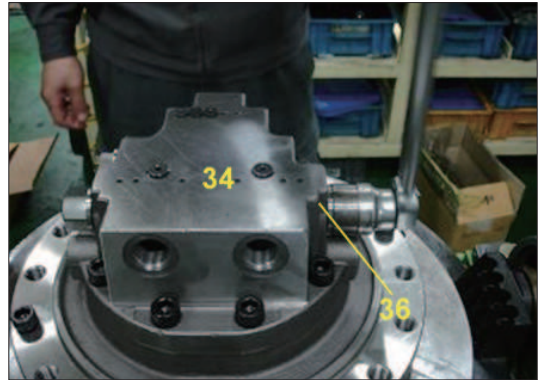

2609A8TM03

- (2) Disassemble wrench bolt (54) using torque wrench.

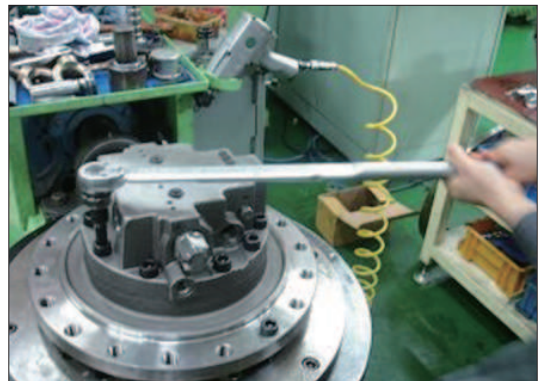

2609A8TM04

- (3) Take out rear cover (34) into casing (1).



2609A8TM05

- (4) Remove brake spring (30, 14EA)



2609A8TM06

(5) Disassemble parking piston (25) using jig.

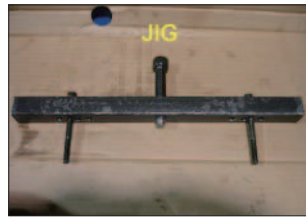

2609A8TM07

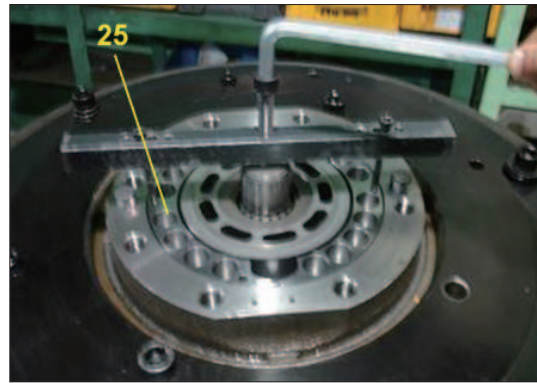

2609A8TM08

(6) Disassemble separate plate (24, 5EA) and friction plate (23, 4EA).

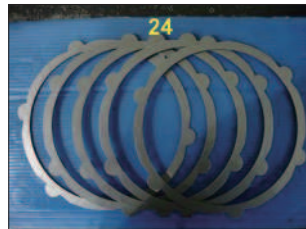

2609A8TM09



2609A8TM10

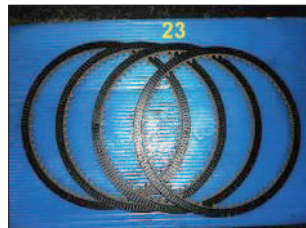

2609A8TM11

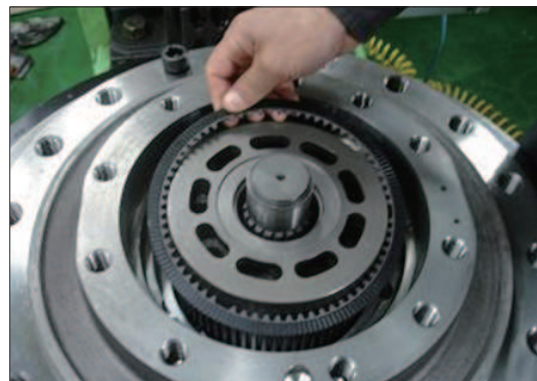

2609A8TM12

(7) Remove cylinder block kit.

It is easier to work by placing the casing (1) horizontal.



2609A8TM13

(8) Disassemble cylinder block (18), retainer plate (21), piston assy (22), ball guide (20) and spring (19) into cylinder block kit.



2609A8TM14



2609A8TM15

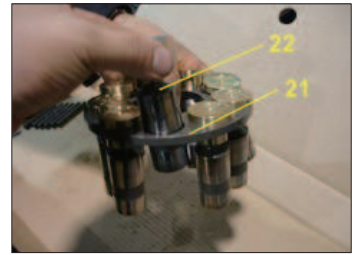

2609A8TM16

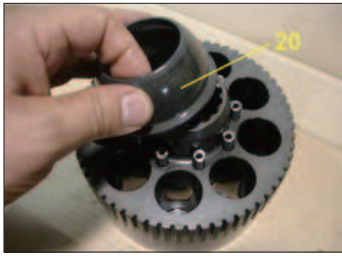

2609A8TM17

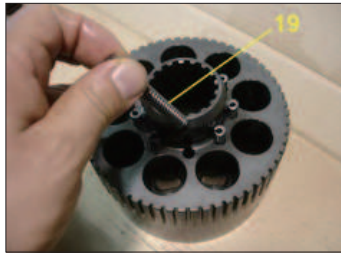

2609A8TM18

(9) Disassemble swash plate (17) into casing (1).



2609A8TM19



2609A8TM20

(10) Disassemble steel ball (15), swash piston (7) into casing (1).

※ Hole in the Casing(1) of two speed line is decomposed by injecting air.



2609A8TM21



2609A8TM22



2609A8TM23

(11) Disassemble pivot (16, 2EA) into casing (1).

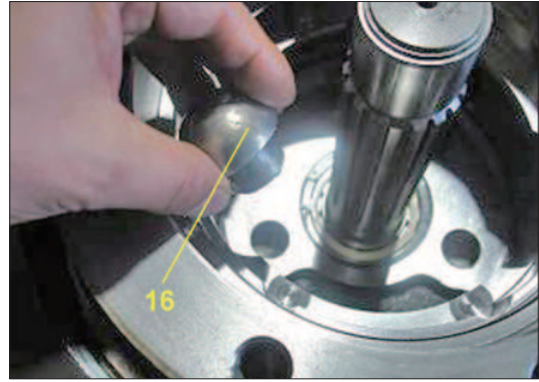

2609A8TM24

(12) Disassemble snap ring (6) using pliers.



2609A8TM25

(13) Disassemble trust block (4) and oil-seal (3) into casing (1).

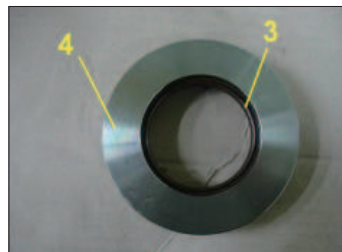

2609A8TM26



2609A8TM27

(14) In the casing (1), the arrow part of the shaft (8) using a rubber mallet taps and then disassemble the shaft (8) and bearing-roller (10) to the other side.

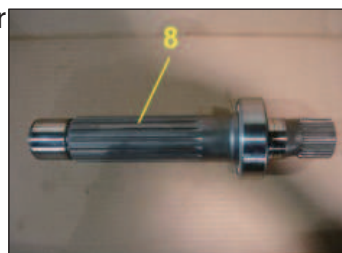

2609A8TM28

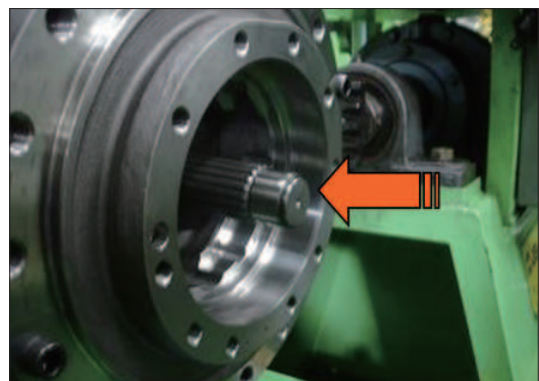

2609A8TM29

(15) Disassemble valve plate (28) into rear cover (34).

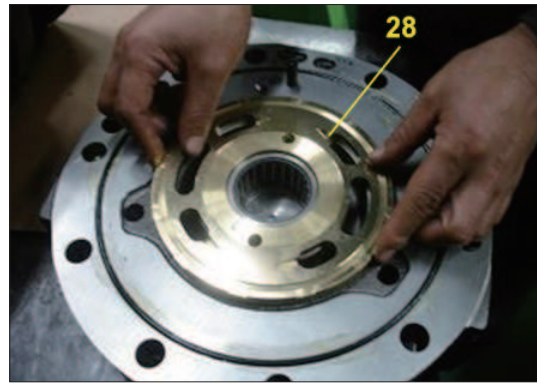

2609A8TM30

(16) Disassemble relief valve (46, 2EA) into rear cover (34) using the torque wrench.



2609A8TM31

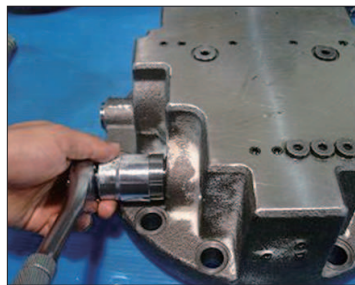

2609A8TM32

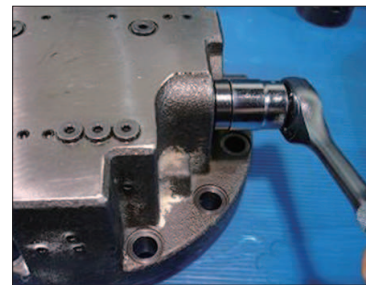

2609A8TM33

(17) Disassemble plug (48), connector (52) into rear cover (34) using the torque wrench and then disassemble spring (51), spring seat (49), parallel pin (50) and spool (47) in regular sequence.



2609A8TM34



2609A8TM35



2609A8TM36

(18) Disassemble plug (57) into rear cover (34).

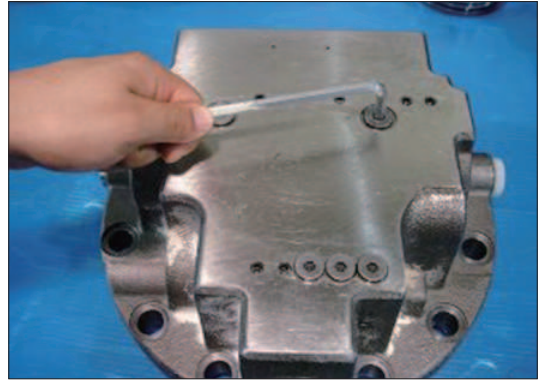

2609A8TM37

(19) Disassemble plug (57) into rear cover (34) and then disassemble spring (56), check valve (55) into rear cover (34) in regular sequence.

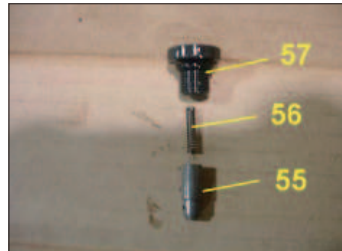

2609A8TM38

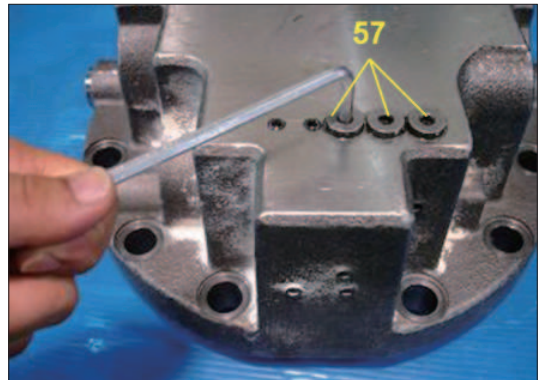

2609A8TM39

4. REASSEMBLING

1) ASSEMBLING MOTOR

- REAR COVER ASSY

- (1) Assemble check valve (55), spring (56) into rear cover (34) and then assemble plug (57) using L-wrench.

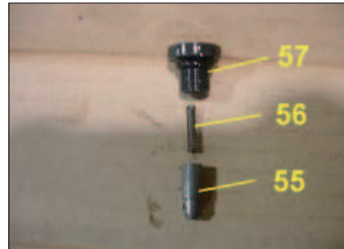

2609A8TM40

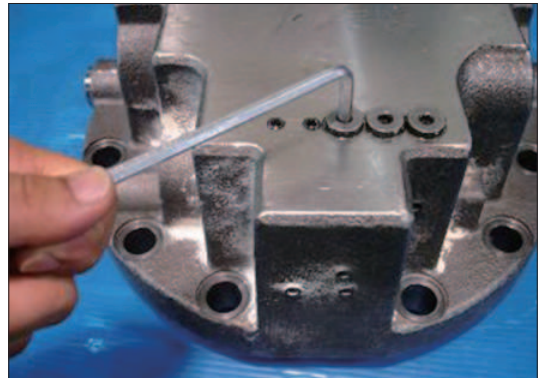

2609A8TM41

- (2) Apply loctite #242 on the NPTF 1/16 plug (2) and then assemble 12-NPTF 1/16 Plug (2) into rear cover(34).



2609A8TM42

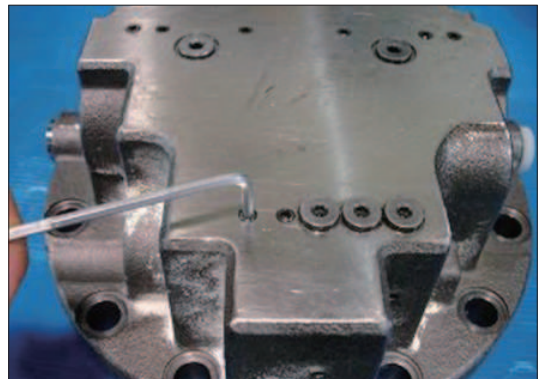

2609A8TM43

- (3) Assemble spool (47), parallel pin (50), spring seat (49) and spring (51) into rear cover (34) in regular sequence and then assemble plug (48) and connector (52).



2609A8TM44



2609A8TM45

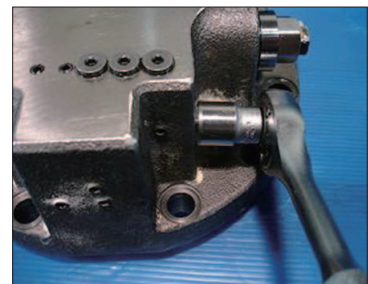

2609A8TM46

- (4) Assemble relief valve (42, 2EA) into rear cover (34).



2609A8TM47

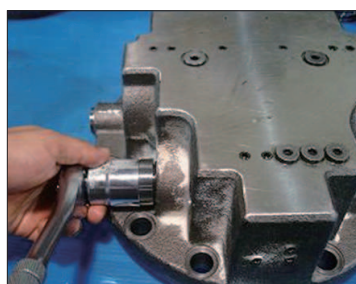

2609A8TM48



2609A8TM49

- (5) Press needle bearing (11) into rear cover (34) using jig.

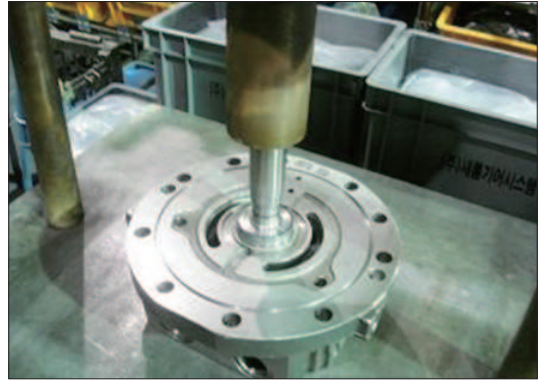

2609A8TM50

- (6) Assemble spring pin (32) and parallel pin (29) using small hammer.



2609A8TM51

- (7) Assemble valve plate (28) into rear cover (34).

- ※ **Apply grease to the valve plate contact and then assemble valve plate into rear cover (34).**



2609A8TM52

- (8) Apply grease to the O-ring and then assemble O-ring into rear cover (34).



2609A8TM53

(9) Install casing (1) into assembling jig.

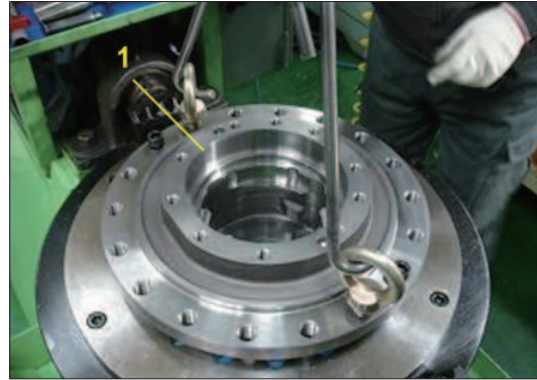

2609A8TM54

(10) Assemble the heated Roller Bearing(10) onto the Shaft(8).

① The temperature of the Roller Bearing : 100°C.

Using tool : Heater.

※ **Be careful not to damage the sliding surface for the Oil seal on the shaft.**



2609A8TM55



2609A8TM56



2609A8TM57

(11) Assemble the heated needle bearing inner ring on the shaft (8).



2609A8TM58

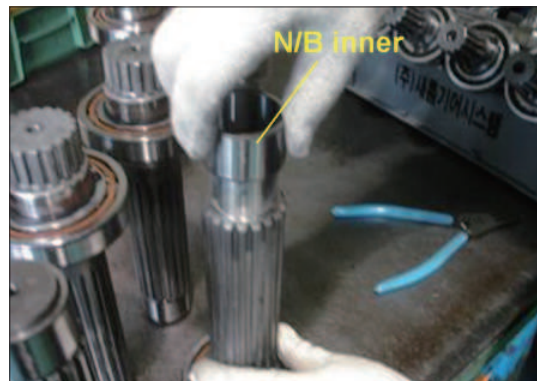

2609A8TM59

(12) Assemble snap ring (13) into Shaft (8) using pliers.



2609A8TM60

(13) Insert assembled shaft assy in the direction of the arrow into casing (1) using a rubber mallet.

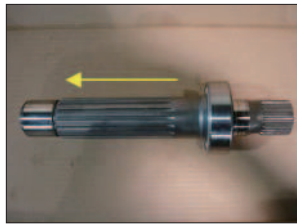

2609A8TM61

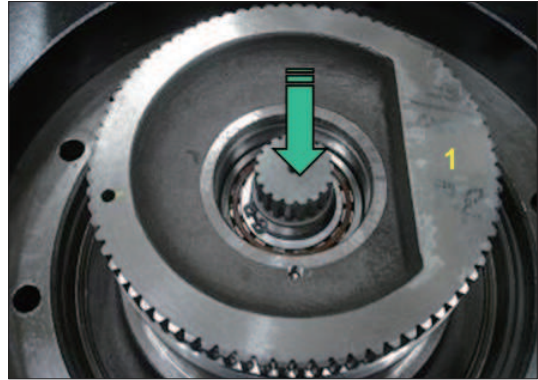

2609A8TM62

(14) Assemble oil seal(3) into trust block (4) with a assembling jig and press it into casing (1). Caution the direction of oil seal (3).

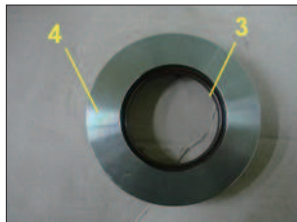

2609A8TM63

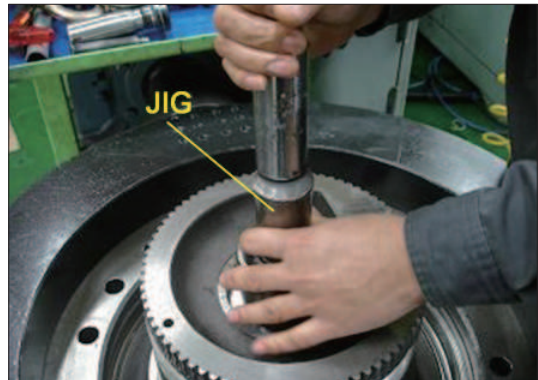

2609A8TM64

(15) Assemble snap ring(6) into casing(1) using pliers.



2609A8TM65

(16) Apply the grease to pivot (16, 2EA) and then assemble pivot (16) into casing(1).

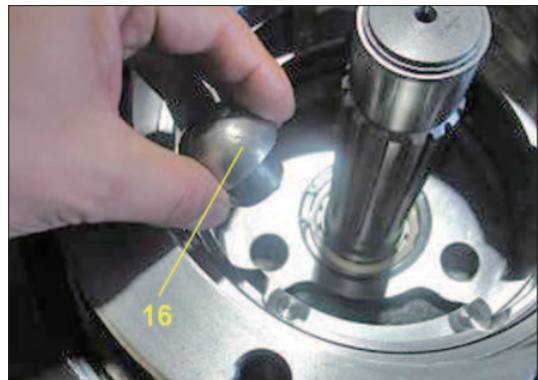

2609A8TM66

(17) Warm piston seal (8) and assemble it on swash piston (7) and then bind the piston seal (8) with a bend for a minute. Remove the bend and assemble it into casing (1).

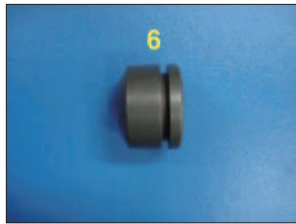

2609A8TM67



2609A8TM68

(18) Apply the grease to steel ball (15) and then assemble steel ball (15) into casing (1).



2609A8TM69



2609A8TM70

(19) Apply the grease to swash plate (17) and then assemble swash plate (17) into casing (1).



2609A8TM71



2609A8TM72

(20) Assemble spring (19), ball guide((20), retainer plate (21), piston assy (22) into cylinder block (18) in regular sequence.

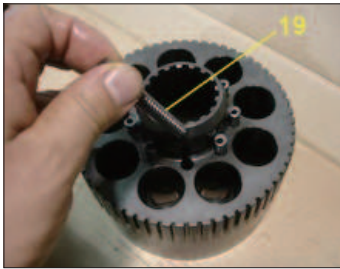

2609A8TM73

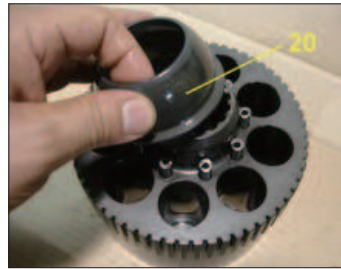

2609A8TM74

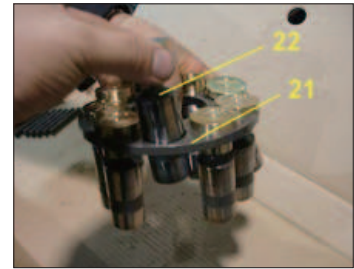

2609A8TM75

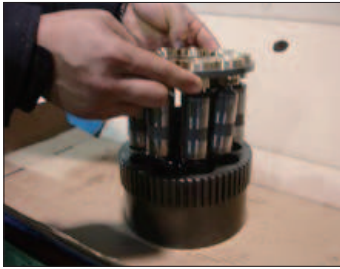

2609A8TM76



2609A8TM77

(21) Start the casing (1) and then assemble cylinder block kit into casing (1).



2609A8TM78

(22) Assemble separated plate (24), friction plate (23) into cylinder block in regular sequence.

Friction plate : 4EA

Separated plate : 5EA



2609A8TM79



2609A8TM80

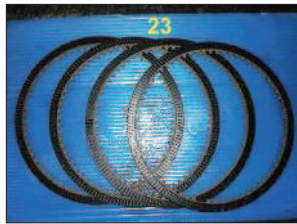

2609A8TM81

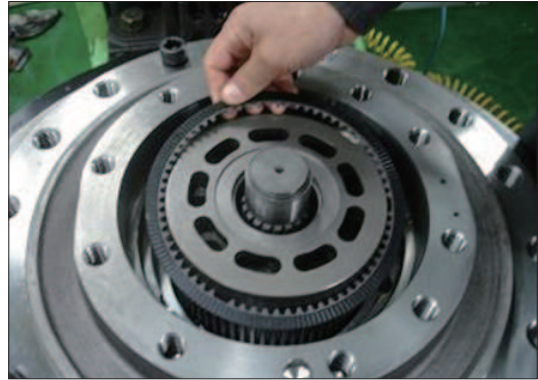

2609A8TM82

(23) Apply the grease to D-ring (26, 27) and then assemble D-ring (26, 27) into parking piston (25).

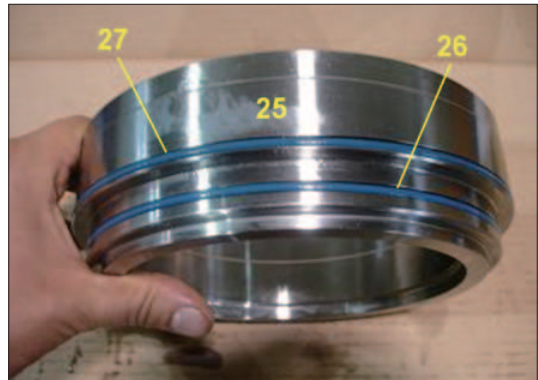

2609A8TM83

(24) Assemble parking piston into casing using jig.

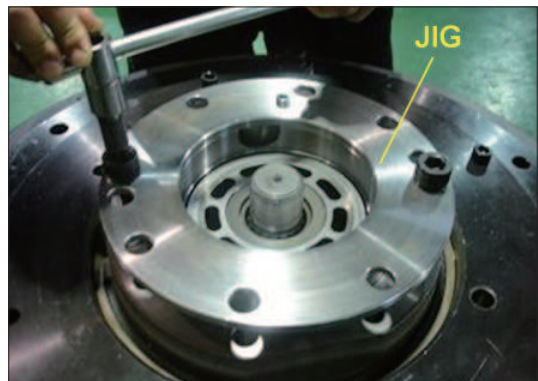

2609A8TM84

(25) Assemble brake spring (30, 18EA).



2609A8TM85

(26) Put on the rear cover (34) on the casing (1).



2609A8TM86

(27) Assemble rear cover (34) into casing (1) and then tighten the wrench bolt (54, 55) using torque wrench.

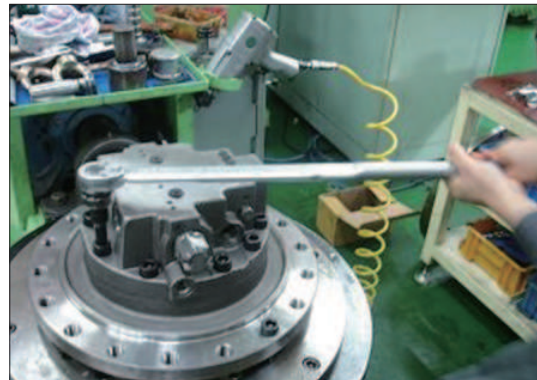

2609A8TM87

(28) Assemble main spool assy (35) into rear cover (34) after checking the direction to be correct.



2609A8TM88

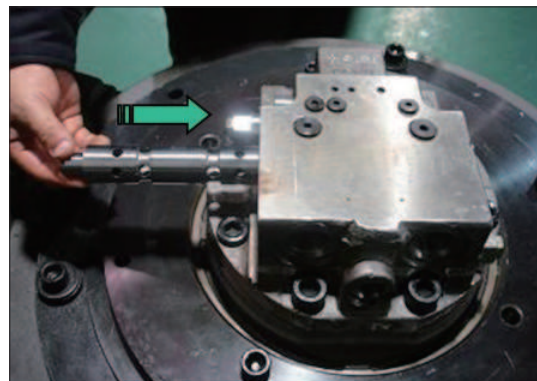

2609A8TM89

(29) Assemble spring (37), plug (36) into rear cover (34) in regular sequence and then plug (36) into rear cover (34) using torque wrench.

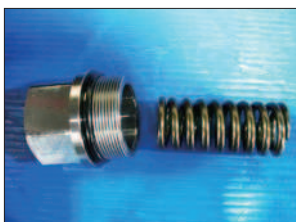

2609A8TM90

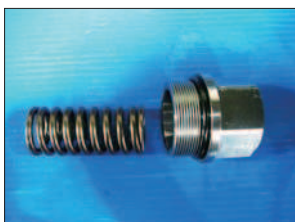

2609A8TM91

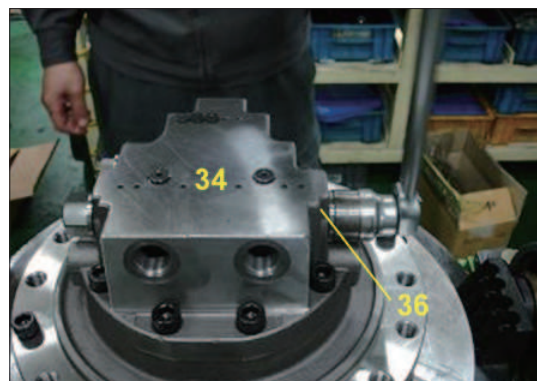

2609A8TM92

2) TRAVEL REDUCTION GEAR

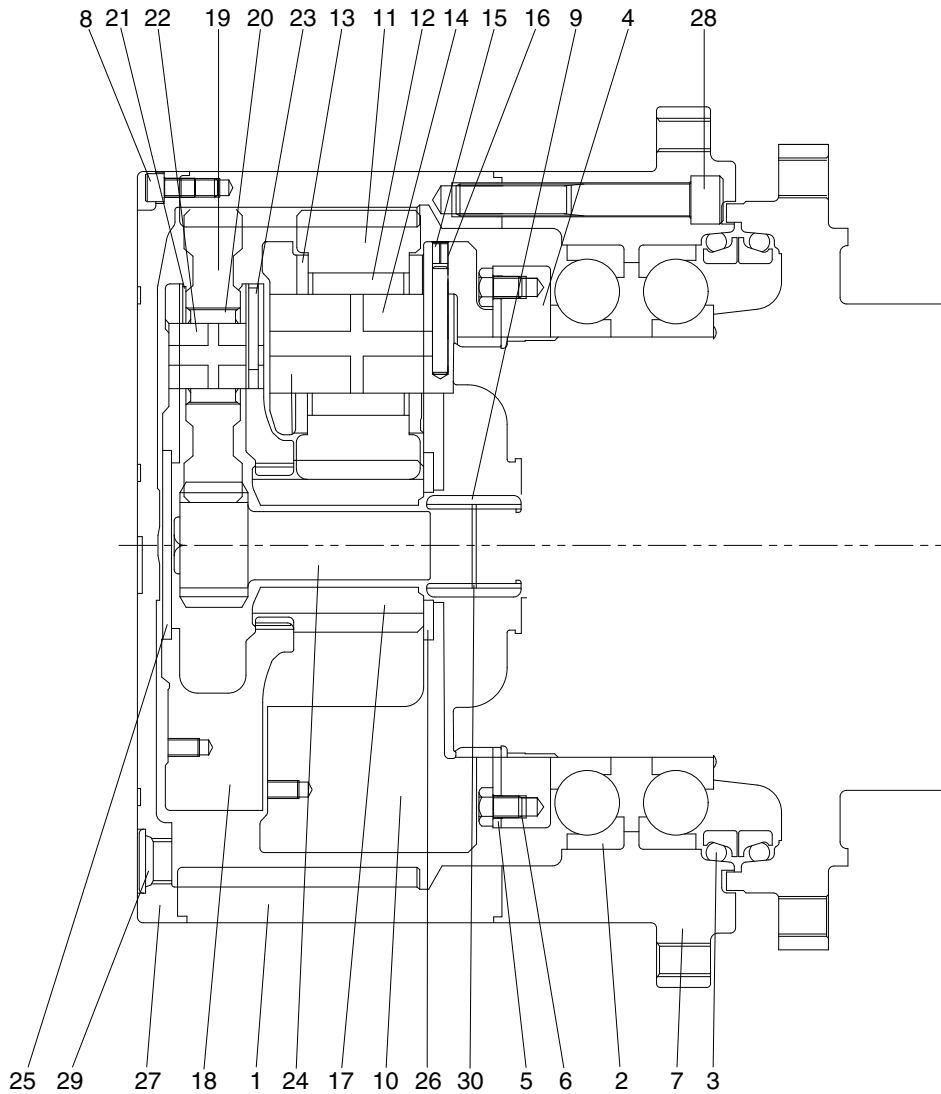

2609A2TM03

- | | | | | | |
|----|--------------------------|----|------------------|----|--------------------------|
| 1 | Gear ring | 11 | Planetary gear 2 | 21 | Thrust washer 1 |
| 2 | Ball bearing | 12 | Needle bearing 2 | 22 | Carrier pin 1 |
| 3 | Floating seal assy | 13 | Thrust washer 2 | 23 | Spring pin 1 |
| 4 | Nut ring | 14 | Carrier pin 2 | 24 | Sun gear 1 |
| 5 | Lock plate | 15 | Spring pin 2 | 25 | Thrust plate |
| 6 | Hexagon socket head bolt | 16 | Solid pin 2 | 26 | Thrust plate |
| 7 | Housing | 17 | Sun gear 2 | 27 | Cover |
| 8 | Hexagon socket head bolt | 18 | Carrier 1 | 28 | Hexagon socket head bolt |
| 9 | Coupling | 19 | Planetary gear 1 | 29 | Plug |
| 10 | Carrier 2 | 20 | Needle bearing 1 | 30 | Snap ring |

6. DISASSEMBLING

1) GENERAL INSTRUCTIONS

- ▲ Combustibles such as white kerosene are used for washing parts.**
These combustibles are easily ignited, and could result in fire or injury.
Be very careful when using.
 - ▲ Internal parts are coated with gear oil during disassembling and are slippery.**
If a part slips off from your hand and falls, it could result in bodily injury or could damage the park.
Be very careful when handling.
- (1) Therefore, disassembling and assembling works should be performed on the clean place where dusts hardly gather.
Tools and kerosene to wash parts should also be clean and handled with great care.
- (2) Before disassembling, review the sectional drawing and prepare the required parts, depending on the purpose and the range of disassembling.
Seals, O-rings, etc., if once disassembled, are not reusable.
There are some parts that should be replaced as a subassembly.
Consult with the parts manual in advance.
- ▲ Take great care not to pinch your hand between parts while disassembling nor let fall parts on your foot while lifting them.**

2) DISASSEMBLING TRAVEL REDUCTION GEAR

(1) Preparation for disassembling

- ① The reduction units removed from excavator are usually covered with mud. Wash outside of propelling unit and dry it.
- ② Locate reducer in order for drain port to be at the lowest level loosen taper screw plug of drain port, and drain oil from reduction gear.

※ While oil is still hot, inside of the unit may be pressurized.

▲ Take care of the hot oil gushing out of the unit when loosening the plug.

③ Mark for mating

Put marks on each mating parts when disassembling so as to reassemble correctly as before.

(2) Set the reduction unit on table

- ① Remove 7/16-14UNC hexagon socket head bolts at 3 places from cover almost equally apart each other, and then install 7/16-14UNC eye bolts.

▲ Take great care not to pinch your hand between parts while disassembling nor let fall parts on your foot while lifting them.

(3) Removing cover

- ① Remove 22 socket bolts (7/16-14UNC) those are attached to ring gear.
- ② Cover is stuck (27) to ring gear (1).
So use sharp chisel for removing cover (27) from ring gear (1).

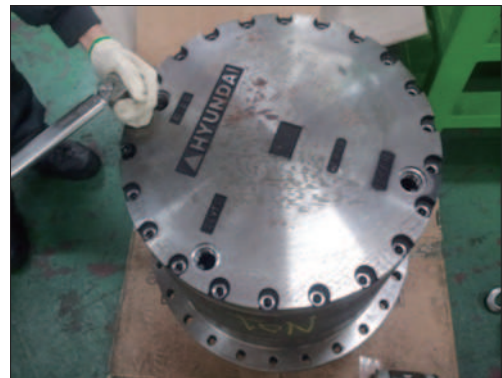

2609A8TM02

(4) Removing sun gear No.1

Pull sun gear No.1 (24) vertically slow after removing thrust plate (25).



2609A8TM03

(5) Removing carrier No.1 sub assembly

Pull away carrier No.1 (18) with attached eye-bolt (M10) that is assembled to hole on carrier sub-assembly.



2609A8TM04

(6) Removing sun gear No.2

Pull away sun gear No.2 (17) for removing.



2609A8TM05

(7) Deassembling carrier No.2 sub-assembly

Attach eye-bolt (M10) to the hole of carrier No.2 (10), and remove the carrier No.2 sub-assembly to lift up slowly.

※ **Keep horizontal to ground and make sure the eye-bolts to be safe operation.**



2609A8TM06

(8) Take away coupling

Take away the coupling (9) from casing (1).



2609A8TM07

(9) Lock plate

Release four hex head bolts (6, M12) and remove lock plate (5).

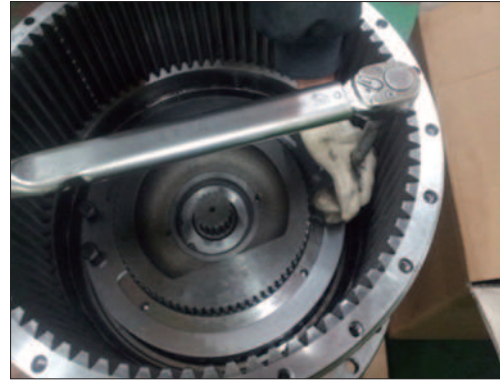

2609A8TM08

(10) Nut ring

Release nut ring with removing jig.



2609A8TM09

(11) Housing sub-assembly

Lift up housing part slowly with hoist after attaching eye-bolt (7/16-14UNC) on it. If you hit softly the center of motor with hammer and particular jig, you can remove the device easily.

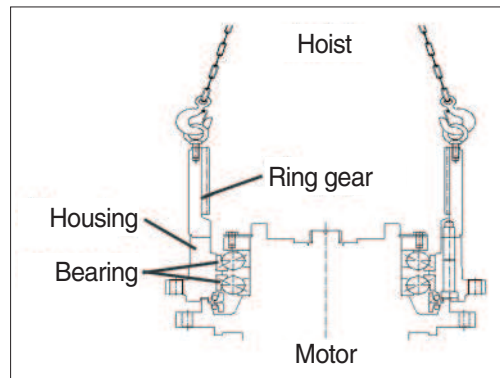

2609A8TM10

(12) Ring gear

- ① Reverse the housing sub-assembly part with machine, and remove floating seal (3) from the inside.



2609A8TM11

- ② Release 25 hex wrench bolts (28. M18) and remove ring gear (1) from housing (7).

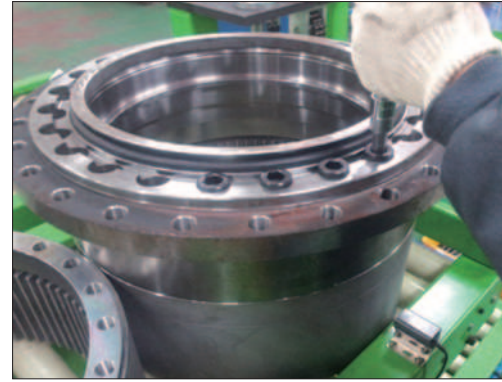

2609A8TM12

(13) Angular Bearing

Put the housing sub-assembly (7) like this figure. And hit each opposite side of bearing with driver and hammer.

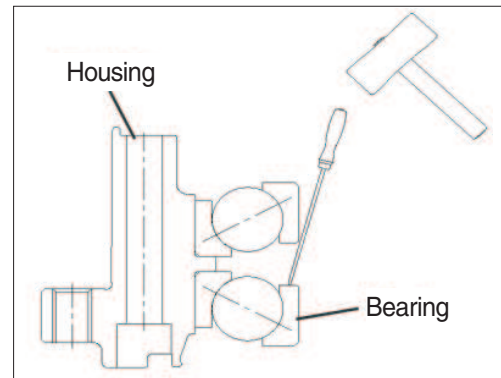

2609A8TM13

(14) Carrier No.1 sub-assembly

- ① Lay it on deassemblig jig. And remove pin No.1 (22) with press machine.



2609A8TM14

- ② Then remove planet gear No.1 (19) and thrust washer No.1 (21) from carrier No.1 (18).



2609A8TM15

(15) Carrier No.2 sub-assembly

Same as carrier No.1 (12) sub-assembly.



2609A8TM16

(16) Coupling

Remove snap ring (30) inside coupling (9) with nipper.



2609A8TM17

7. ASSEMBLY REDUTION UNIT

1) GENERAL NOTES

- (1) Clean every part by kerosene and dry them by air blow.
- (2) Surfaces to be applied by loctite must be decreased by solvent.
- (3) Check every part for any abnormal.
- (4) Each hexagon socket head bolt should be used with loctite No.242 applied on its threads.
- (5) Apply gear oil slightly on each part before assembling.

**▲ Take great care not to pinch your hand between parts or tools while assembling nor let fall parts on your foot while lifting them.
Inspection before reassembling.**

Thrust washer

- Check if there are seizure, abnormal wear or uneven wear.
- Check if wear is over the allowable limit.

Gear

- Check if there are pitting or seizure on the tooth surface.
- Check if there are cracks on the root of tooth by die check.

Bearing

- Rotate by hand to see if there are something unusual such as noise or uneven rotation.

Floating seal

- Check flaw or score on sliding surfaces or O-ring.

2) ASSEMBLING CARRIER 1 SUB-ASSY

- (1) Put carrier No.1 (18) on the flat table.
- (2) Insert needle bearing No.1 (20) in planet gear No.1 (20), and attach 2 thrust washers No.1 (21) on the both side of planet gear No.1. then assemble them in carrier No.1 (18).

※ When assembling thrust washer, rounded edge-side should be facing casting side of carrier.

- (3) Insert pin No.1 (22) into pinhole of carrier correctly.

※ Insert careful the pin not to scratch thrust washer and needle bearing.



2609A8TM18



2609A8TM19

(4) Press spring pin No.1 (23) with jig and strike round spring pinhole (2 symmetrical point) with tool.

※ **After striking, draw the line by marker pen.**

※ **Check swinging conditon of planet gears.**

(5) Press two more pins and spring pins on the same way.



2609A8TM20

3) ASSEMBLING CARRIER 2 SUB-ASSY

(1) Put thrust plate (26) inside of carrier No.2 (10).



2609A8TM21

(2) Insert needle bearing No.2 (12) in planet gear No.2 (11) and attach 2 thrust washers No.2 (13) on the both side of planet gear No.2. Then assemble them in carrier No.2 (10).

※ **When assembling thrust washer, rounded edge-side should be facing casting side of carrier.**

(3) Insert pin No.2 (14) into pinhole of carrier No.2 correctly.

※ **Insert careful pin No.2 not to scratch thrust washer and needle bearing.**



2609A8TM22

(4) Insert solid pin No.2 (16) with pressing jig and insert spring pin No.2 (15) in the same position. When insertion is done, strike inner circle of spring pin (2 symmetrical point) with tool.

※ **After striking, draw the line by marker pen.**

※ **Check the spining condition of planet gear.**

(5) Insert two more pins and spring pins on the same way.



2609A8TM23

4) ANGULAR BEARING

(1) Put the jig on housing (7) and insert angular bearing (2) into it with pressing machine, and turn down the upside of housing (7) by reversing machine.

※ Check the direction of bearing when inserting it.

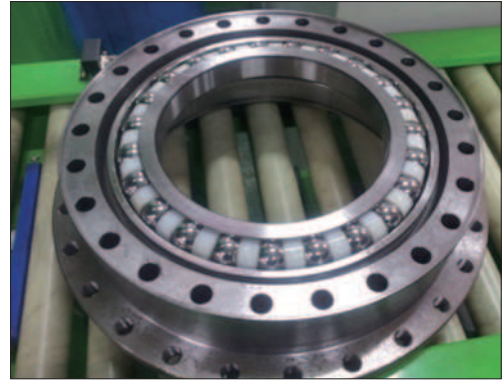

2609A8TM24

(2) Insert angular bearing (2) into reversed housing (7) on the same way.

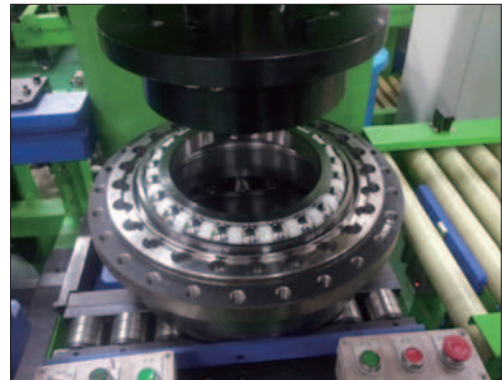

2609A8TM25

5) ASSEMBLING FLOATING SEAL

(1) Paint alchole on floating seal (3) and polish it.



2609A8TM26

(2) Put floating seal (3) on the right position of housing (3) and insert it by pressing jig. After complete, check the condition by lifting with hand softly.

※ Keep clean on surface of floating seal while assembling.



2609A8TM27

(3) Put the gauge for seal measurement on floating seal (3) and check the horizontal angle by gauge scale.

※ **Two gauge scales should be same.**
(pass inspection)



2609A8TM28

(4) Attach floating seal to motor that will be assembled with housing (on the same way to (1), (2))



2609A8TM29

(5) Put the measuring jig on floating seal (3) and check the horizontal angle condition with both gauge scale.

※ **Two gauge scales should be same.**
(pass inspection)

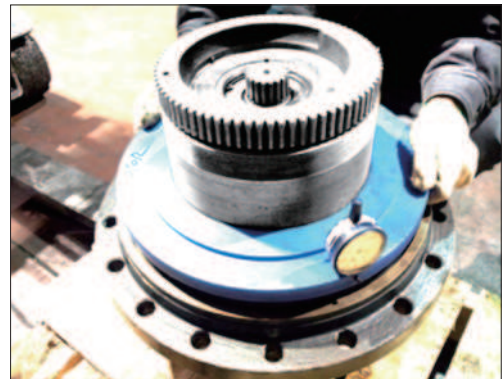

2609A8TM30

6) ASSEMBLING RING GEAR

(1) Put ring gear (1) on contact surface (should be upside) of housing (7).

(2) Paint loctite #515 on ring gear (1) and put on housing (7). Then assemble 25 hexwrench bolts (28, M18)

※ **Paint loctite #262 on hex-wrench bolts (28) before assembling.**

※ **Tightening torque : 38.5 ± 3.8 kgf · m**
(278.5 ± 27.5 lbf · ft)

※ **Bolts should be assembled with luster preventing oil.**

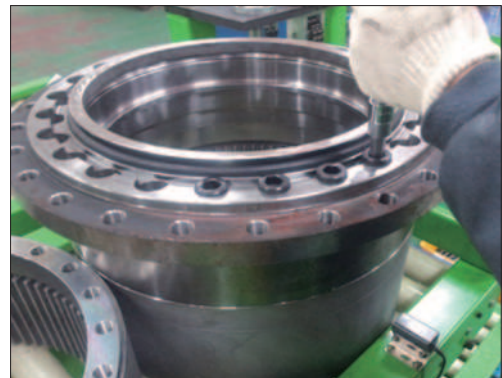

2609A8TM31

7) ASSEMBLING NUT RING

- (1) Put housing (7) sub-assembly upside down (ring gear side is up), and attach it to motor by lifting with hoist. (shaking it lightly)
 - (2) When housing (7) sub-assembly is set, put nut ring (4) on it, and assemble with jig.
- ※ **Tightening torque for assembling nut ring :**
 $66 \pm 6.0 \text{ kgf} \cdot \text{m}$ ($477.3 \pm 43.3 \text{ lbf} \cdot \text{ft}$)
 - ※ **Floating seal should not be damaged or separated while assembling.**



2609A8TM32

8) ASSEMBLING LOCK PLATE

- (1) Put lock plate (5) on nut ring (4) to fit to M12 bolt hole. Then assemble 4 hex-head bolts (6, M12)
- ※ **Paint loctite #262 on hex-head bolts.**
 - ※ **Tightening torque : $6.05 \pm 0.6 \text{ kgf} \cdot \text{m}$**
 $(43.8 \pm 4.3 \text{ lbf} \cdot \text{ft})$
 - ※ **Bolts should be assembled with lust preventing oil.**



2609A8TM33

9) ASSEMBLING COUPLING

- (1) Attach snap ring (3) into coupling (9) with nipper.



2609A8TM34

- (2) Put coupling (9) on motor shaft to fit.



2609A8TM35

10) ASSEMBLING NO.2 CARRIER SUB-ASSY

- (1) Lift carrier No.2 subassembly and put on ring gear (1), and fit it into internal side of ring gear (1). Then hit urethan hammer to fit.

※ Check turning and cocking condition before assembling.



2609A8TM36

11) ASSEMBLING NO.2 SUN GEAR

- (1) Insert sun gear No.2 (17) in the middle of carrier No.2 sub assembly and make it fit in carrier No.2.



2609A8TM37

12) ASSEMBLING NO.1 CARRIER SUB-ASSY

- (1) Lift carrier No.1 sub-assembly and put it into ring gear (1) and shake carrier No.1 to fit into ring gear.

※ Check turning and cocking condition before assembling.



2609A8TM38

13) SWINGING TORQUE INSPECTION

- (1) Attach inspection jig before assembling sun gear No.1 (24).



2609A8TM39

(2) Attach torque wrench to the jig, check the torque when it swings.

※ **Swinging torque : below 3.0 kgf · m (21.7 lbf · ft)**



2609A8TM40

14) ASSEMBLING NO.1 SUN GEAR

(1) Remove the jig and wrench after torque inspection complete. And assemble sun gear No.1 (24) with pushing round to fix to the center of carrier No.1



2609A8TM41

15) ASSEMBLING THRUST PLATE

(1) Put thrust plate (25) on carrier No.1 sub assembly. And paint loctite #515 on flat side of ring gear (1).

※ **When assembling thrust washer, rounded edge-side should be facing casting side of carrier.**



2609A8TM42

16) ASSEMBLING COVER

(1) Attach cover on ring gear (1) with assembling 22 hex-wrench bolts (8, 7/16-16UNC).

※ **Paint loctite #262 on screw of hex bolts.**

※ **Tightening torque : 8.1 ± 0.8 kgf · m
(58.6 ± 5.8 lbf · ft)**

※ **Bolts should be assembled with luster preventing oil.**

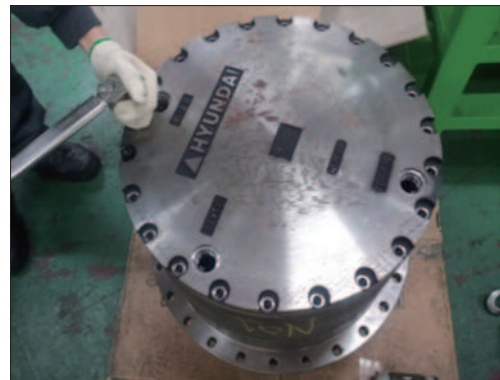

2609A8TM43

17) ASSEMBLING OIL INJECTION

- (1) Inject the oil (10 ℓ) through PF3/4 hole on cover (27).



2609A8TM44

18) ASSEMBLING PLUG

- (1) Assemble 3 plugs (29, PF3/4) after oil injection complete.

※ **Tightening torque : 10 ± 1.0 kgf · m**
(72.3 ± 7.2 lbf · ft)



2609A8TM45