

GROUP 5 UNDERCARRIAGE

UNDERCARRIAGE MOUNTING

ADJUST COMPONENT

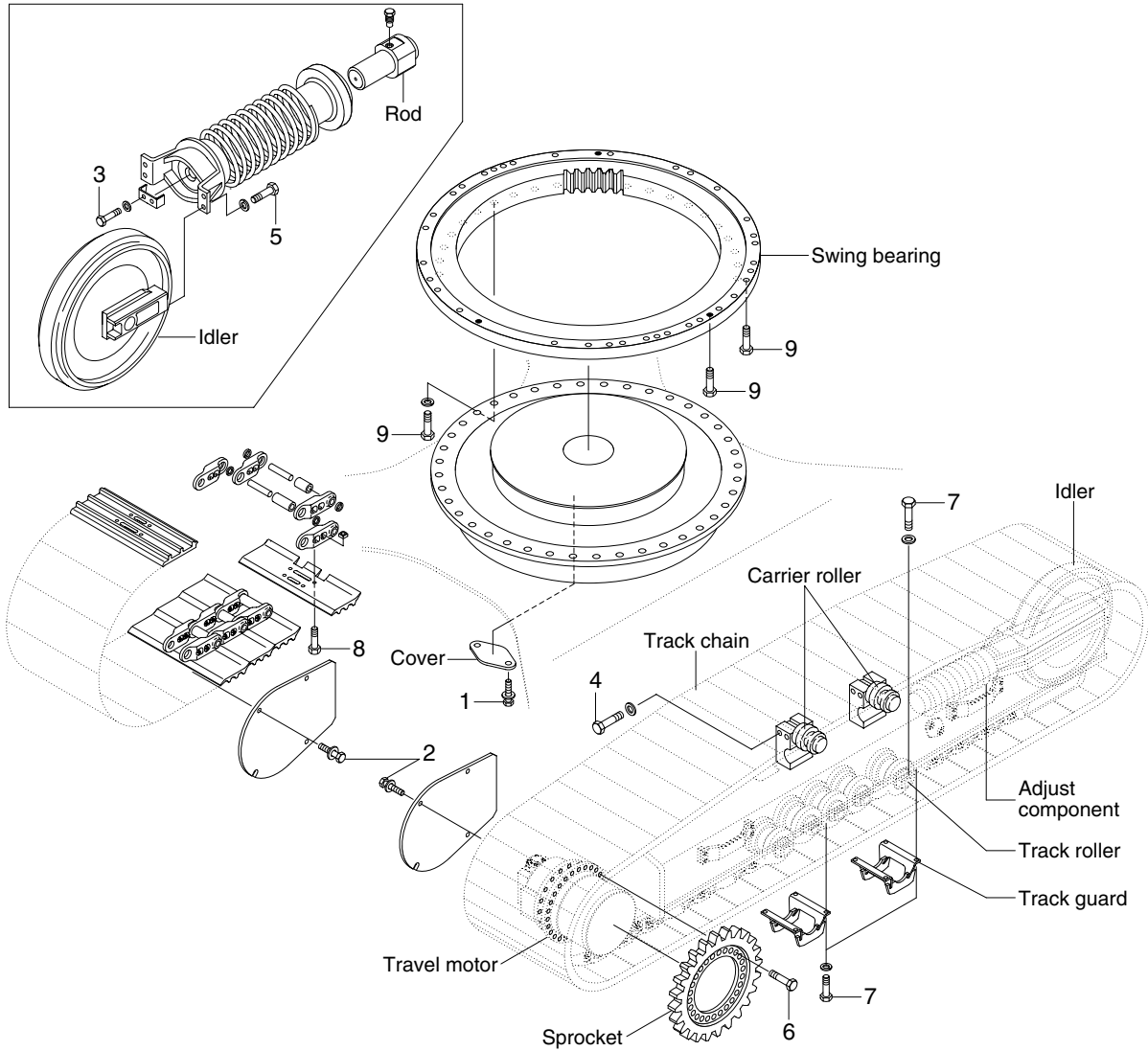

29079CM08

· Tightening torque

Item	Size	kgf · m	lbf · ft
1	M10×1.5	6.9±1.4	49.9±10.1
2	M12×1.75	12.8±3.0	92.6±21.7
3	M12×1.75	15±0.5	108±3.6
4	M16×2.0	29.7±4.5	215±32.5
5	M16×1.5	31.3±4.7	226±34

Item	Size	kgf · m	lbf · ft
6	M20×2.5	57±6.0	412±43.3
7	M20×2.5	57.9±8.6	419±62.2
8	M22×1.5	115±5.0	831±36
9	M24×3.0	97.8±10	707±72.3
-	-	-	-

UNDERCARRIAGE MOUNTING(HIGH WALKER)

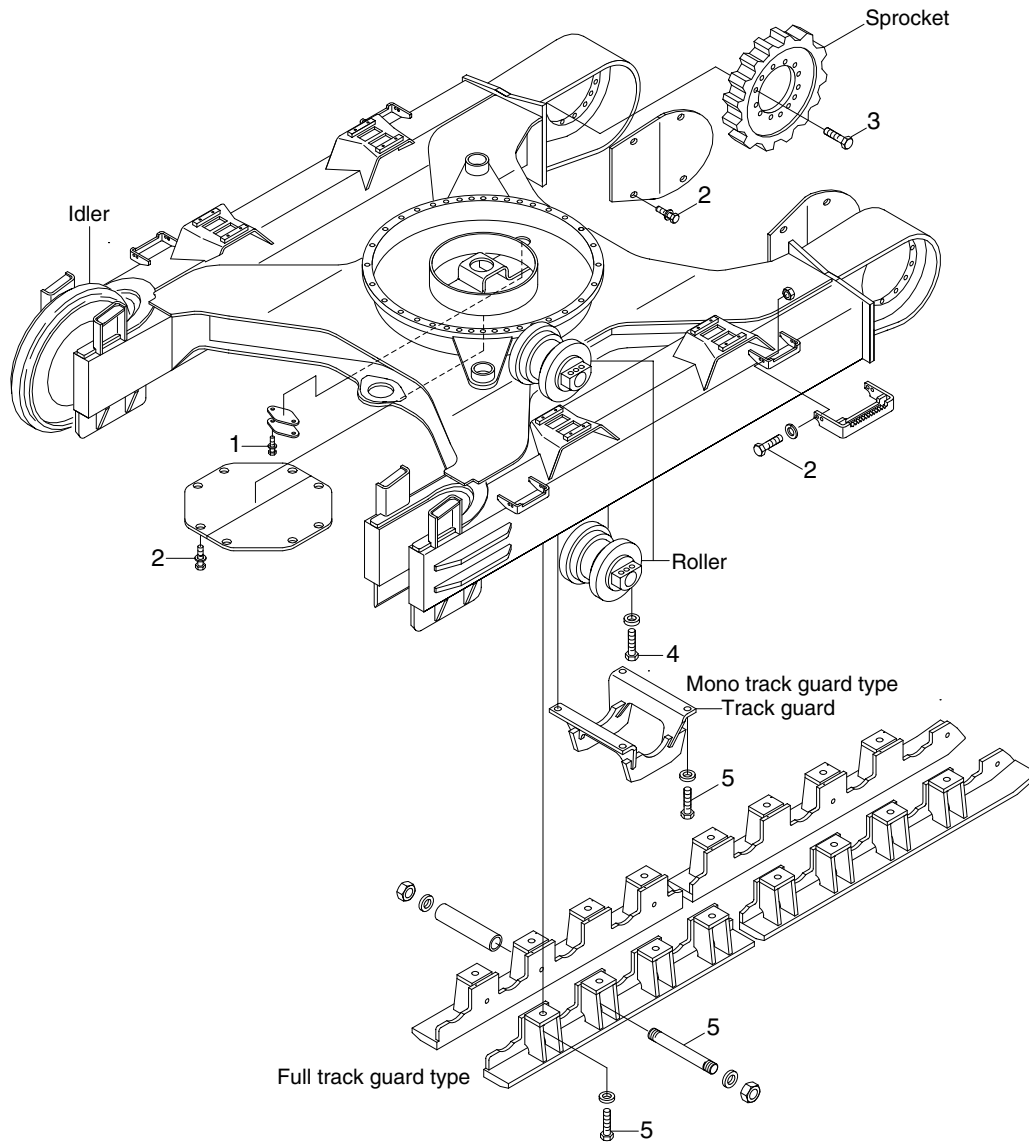

29079CM11

· Tightening torque

Item	Size	kgf · m	lbf · ft
1	M10×1.5	6.9±1.4	49.9±10.1
2	M12×1.75	12.2±1.3	88.2±9.4
3	M20×2.5	51±4.0	369±28.9

Item	Size	kgf · m	lbf · ft
4	M20×2.5	57.9±8.6	419±62.2
5	M24×3.0	100±15	723±108
6	-	-	-