

GROUP 2 ELECTRICAL CIRCUIT

ELECTRICAL CIRCUIT (1/2, SERIAL NO. : -#1634)

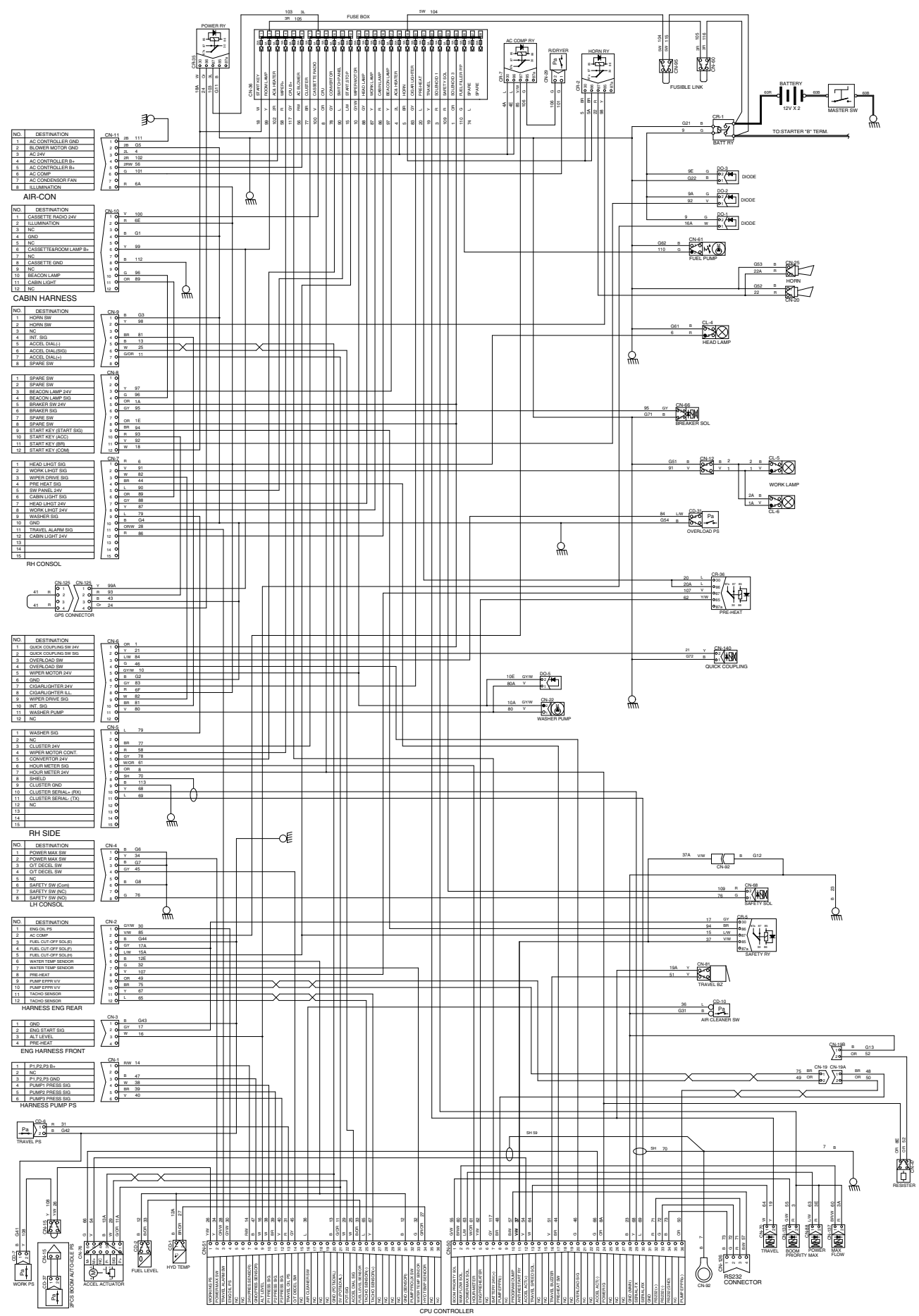
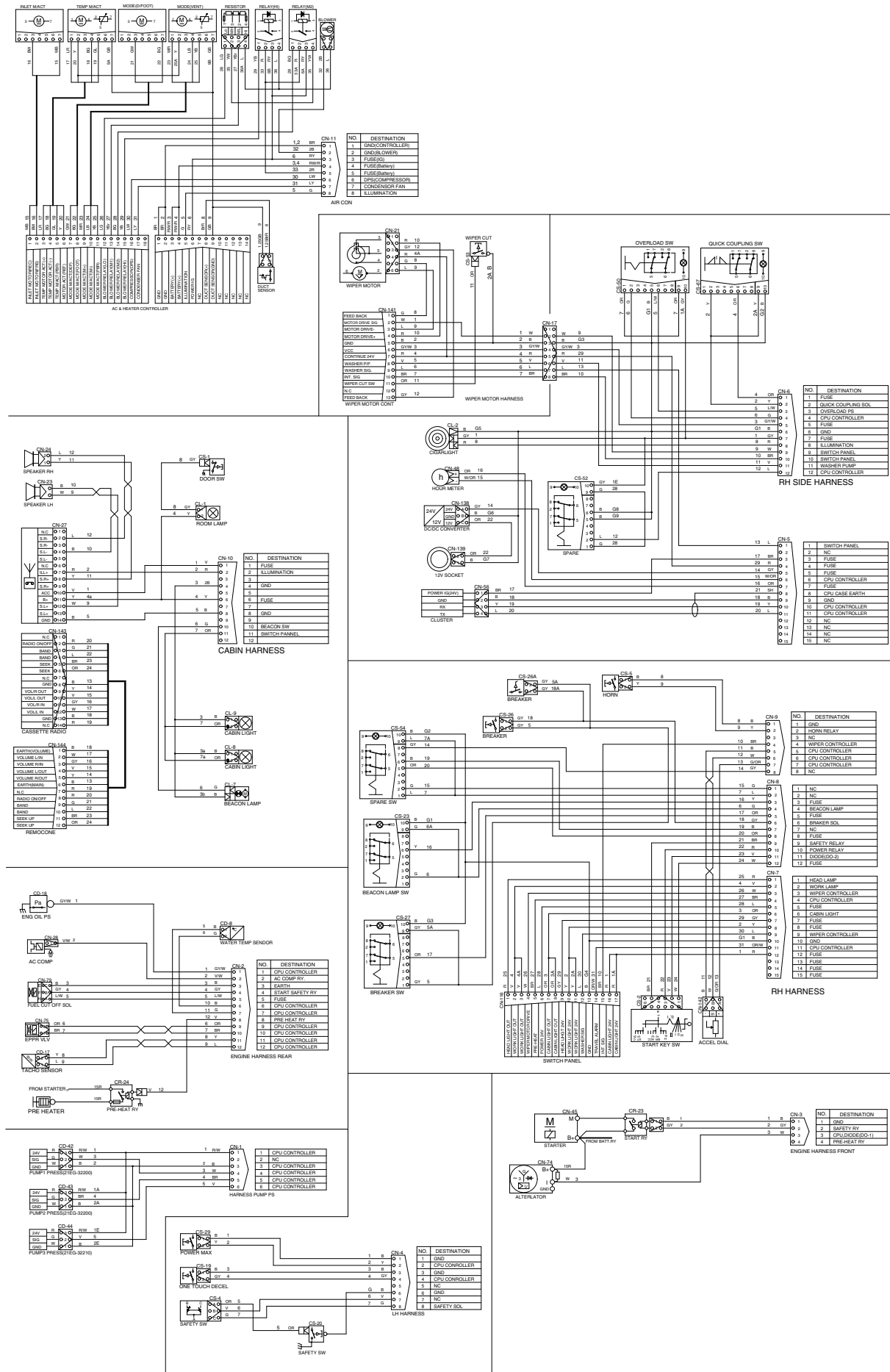

1. POWER CIRCUIT

The negative terminal of battery is grounded to the machine chassis through master switch.

When the start switch is in the OFF position, the current flows from the positive battery terminal as shown below.

1) OPERATING FLOW

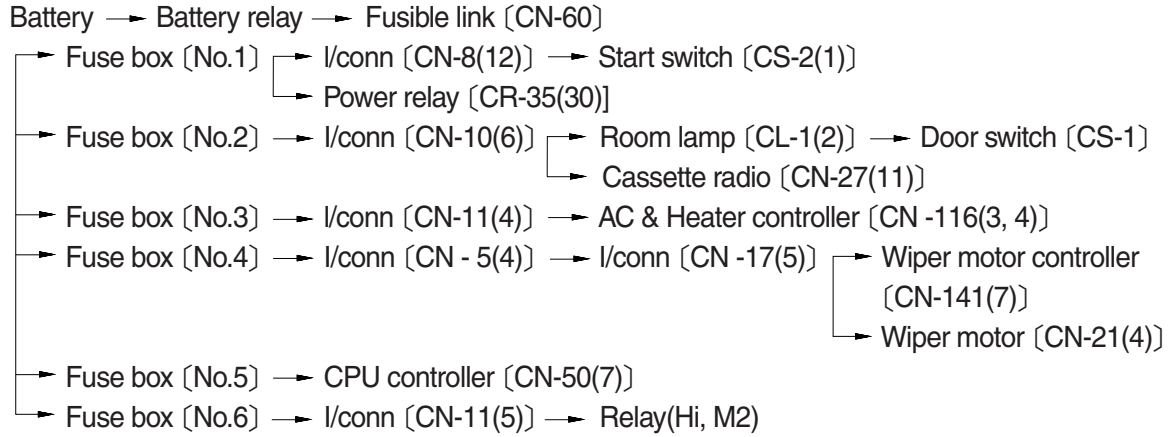

※ I/conn : Intermediate connector

2) CHECK POINT

Engine	Start switch	Check point	Voltage
OFF	OFF	① - GND (Battery 1EA) ② - GND (Battery 2EA) ③ - GND (Battery 2EA) ④ - GND (Fusible link)	10~12.5V 20~25V 20~25V 20~25V

※ GND : Ground

2. STARTING CIRCUIT

1) OPERATING FLOW

Battery(+) terminal → Battery relay [CR-1] → Reset button [CS-61] → Fuse box [No.1]
 → I/conn [CN-8(12)] → Start switch [CS-2(1)]

(1) When start key switch is in ON position

→ Start switch ON [CS-2(2)] → I/conn [CN-8(11)] → Battery relay [CR-1]
 → Battery relay operating (All power is supplied with the electric component)
 → Start switch ON [CS-2(3)] → I/conn [CN-8(10)] → Power relay [CR-35(86) → (87)]
 → Fuse box [No.12] → I/conn [CN-2(5)] → Fuel cut-off [CN-79 (1)]

(2) When start key switch is in START position

Start switch START [CS-2(5)] → I/conn [CN-8(9)] → Safety relay [CR-5(86) → (30)]
 → I/conn [CN-3(2)] → Start relay [CR-23]
 → I/conn [CN-2(4)] → Fuel cut off [CN-79(2)]

2) CHECK POINT

Engine	Start switch	Check point	Voltage
OPERATING	START	① - GND(Battery) ② - GND(Start key) ③ - GND(Battery relay M4) ④ - GND(Starter B ⁺) ⑤ - GND(Starter M) ⑥ - GND(Start relay) ⑦ - GND(Battery relay M8)	20~25V

※ GND : Ground

STARTING CIRCUIT

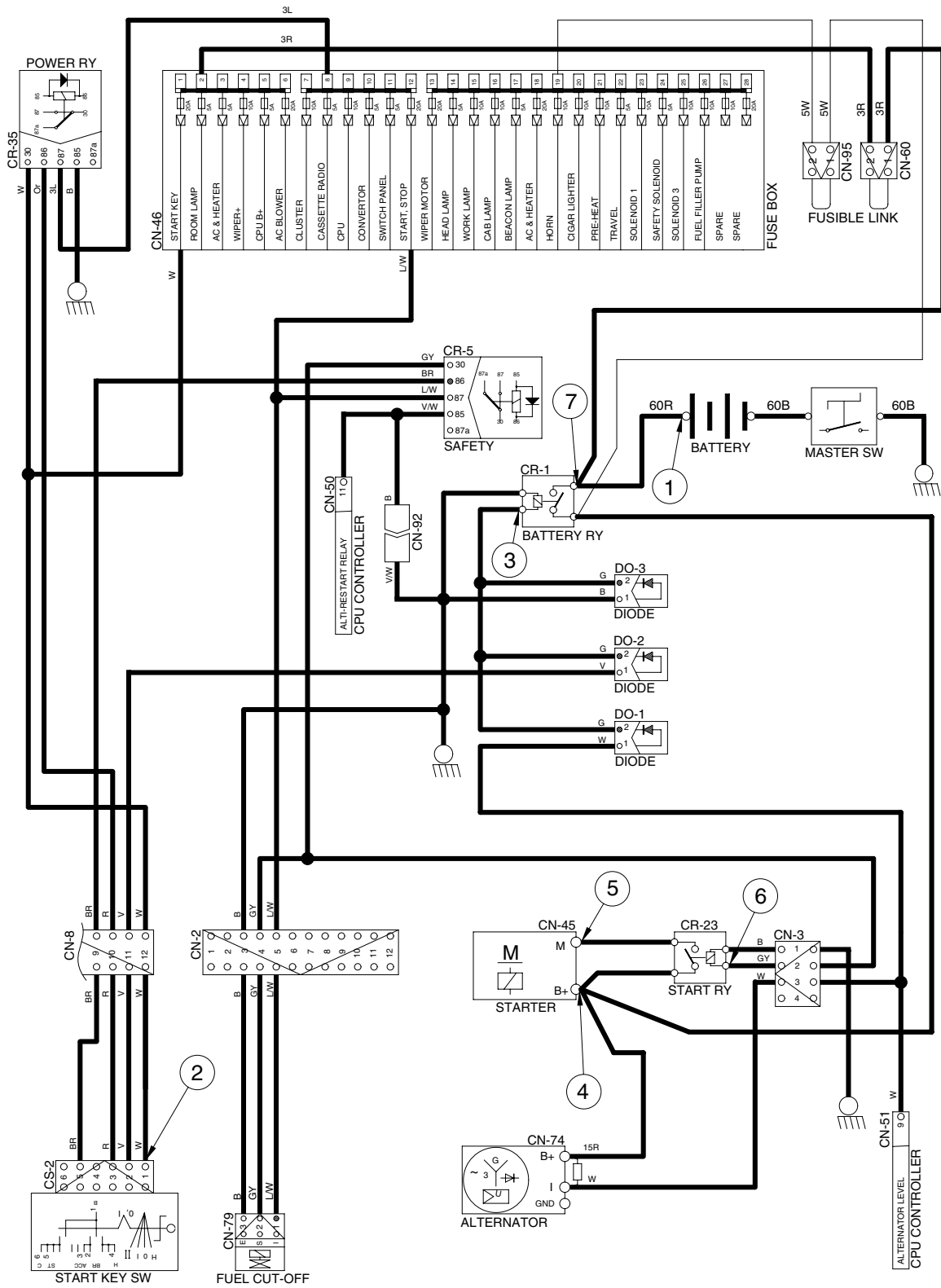

3. CHARGING CIRCUIT

When the starter is activated and the engine is started, the operator releases the key switch to the ON position.

Charging current generated by operating alternator flows into the battery through the battery relay (CR-1).

The current also flows from alternator to each electrical component and controller through the fuse box.

1) OPERATING FLOW

(1) Warning flow

Alternator "I" terminal → I/conn [CN-3(4)] → CPU alternator level [CN-51(9)]
Cluster charging warning lamp(Via serial interface)

(2) Charging flow

Alternator "B+" terminal → Battery relay(M8) → Battery(+) terminal
Reset button [CS-61] → Fuse box

2) CHECK POINT

Engine	Start switch	Check point	Voltage
Run	ON	① - GND(Battery voltage) ② - GND(Battery relay) ③ - GND(Alternator B ⁺ terminal) ④ - GND(Alternator I terminal) ⑤ - GND(CPU)	20~30V

※ GND : Ground

CHARGING CIRCUIT

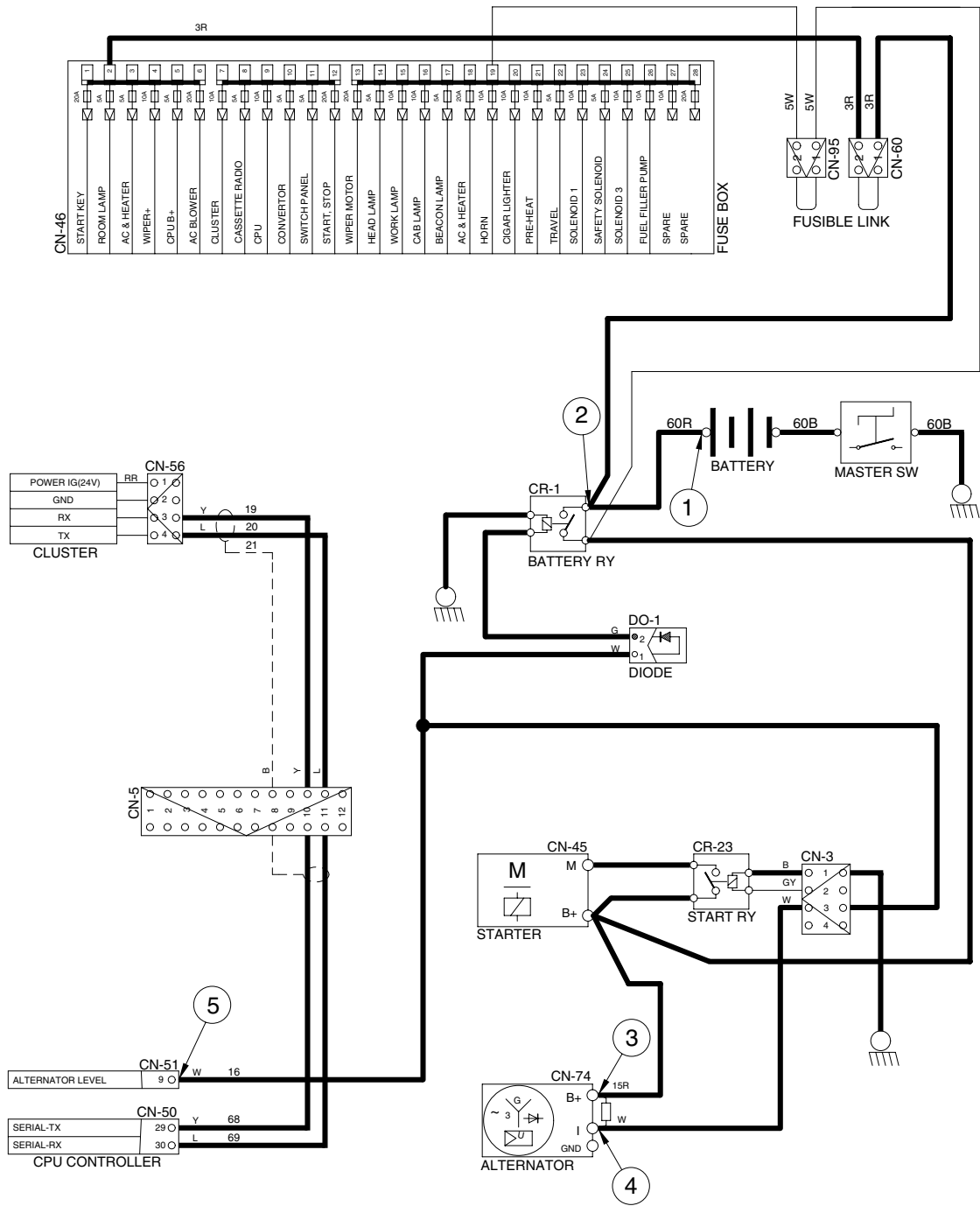

30574EL06

4. HEAD AND WORK LIGHT CIRCUIT

1) OPERATING FLOW

Fuse box (No.14) → I/conn [CN-7(7)] → Switch panel [CN-116(9)]

Fuse box (No.15) → I/conn [CN-7(8)] → Switch panel [CN-116(10,11)]

(1) Head light switch ON

Head light switch ON [CN-116(1)] → I/conn [CN-7(1)]

→ Head light ON [CL-4(2)]

→ I/conn [CN-10(2)] → Cassette radio illumination ON [CN-27(7)]

→ I/conn [CN-11(8)] → AC & Heater controller illumination ON

→ I/conn [CN-6(8)] → Cigarlight [CL-2]

(2) Work light switch ON

Work light switch ON [CN-116(2,3)] → I/conn [CN-7(2)] → I/conn [CN-12(1)]

→ Work light ON [CL-5(2), CL-6(2)]

2) CHECK POINT

Engine	Start switch	Check point	Voltage
STOP	ON	① - GND(Fuse box) ② - GND(Switch power input) ③ - GND(Switch power output) ④ - GND(Head light)	20~25V
STOP	ON	⑤ - GND(Fuse box) ⑥ - GND(Switch power input) ⑦ - GND(Switch power output) ⑧ - GND(Work light)	20~25V

※ GND : Ground

HEAD AND WORK LIGHT CIRCUIT

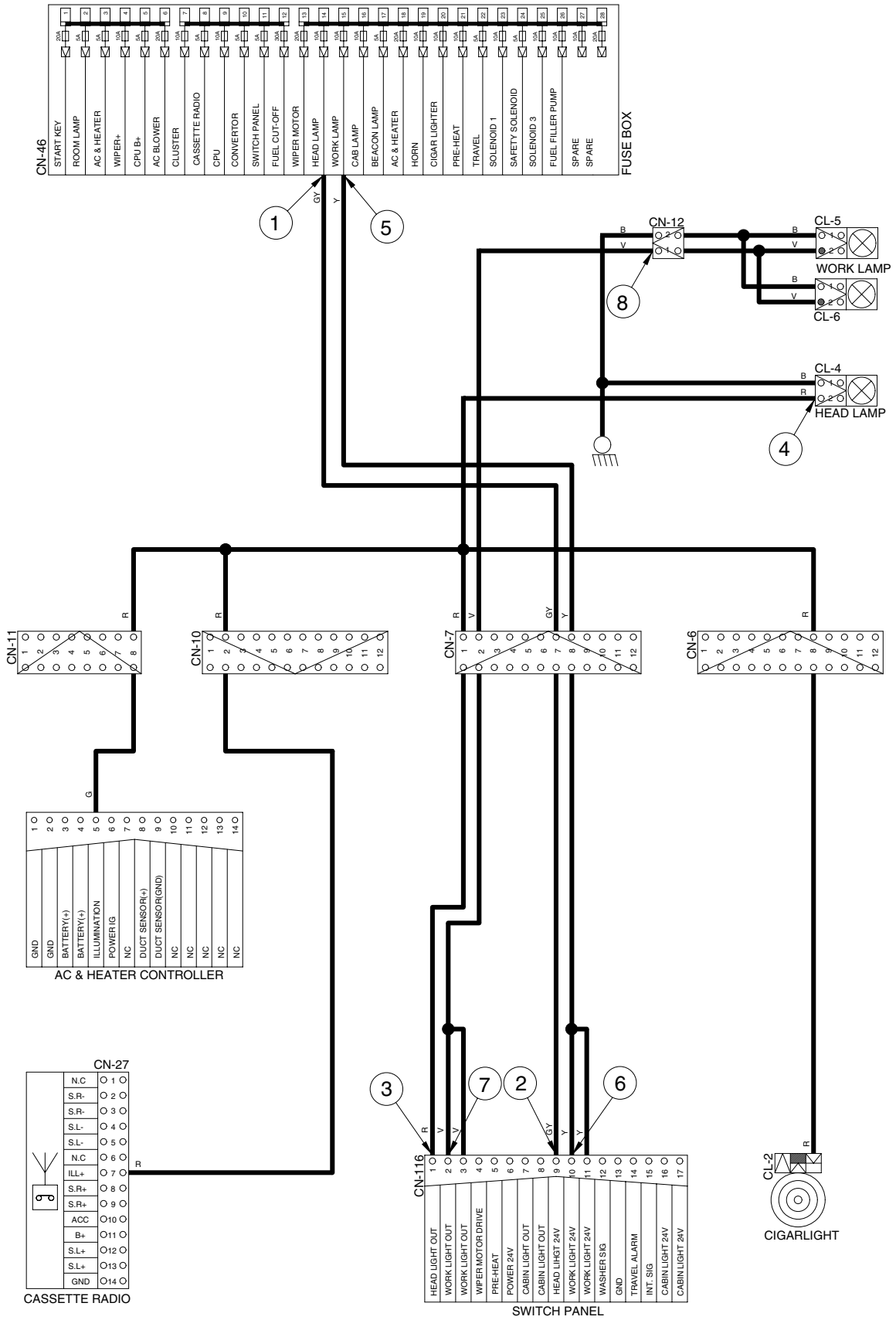

5. BEACON LAMP AND CAB LIGHT CIRCUIT

1) OPERATING FLOW

Fuse box (No.17) → I/conn [CN-8(3)] → Beacon lamp switch [CN-23(6)]

Fuse box (No.16) → I/conn [CN-7(12)] → Switch panel [CN-116(16, 17)]

(1) Beacon lamp switch ON

Beacon lamp switch ON [CS-23(2)] → Switch Indicator lamp ON [CS-23(9)]
 → I/conn [CN-8(4)] → I/conn [CN-10(10)]
 → Beacon lamp ON [CL-7]

(2) Cab light switch ON

Cab light switch ON [CN-116(7, 8)] → I/conn [CN-7(6)] → I/conn [CN-10(11)]
 → Cab light ON [CL-8(2), CL-9(2)]

2) CHECK POINT

Engine	Start switch	Check point	Voltage
STOP	ON	① - GND(Fuse box) ② - GND(Switch power input) ③ - GND(Switch power output) ④ - GND(Beacon lamp)	20~25V
STOP	ON	⑤ - GND(Fuse box) ⑥ - GND(Switch power input) ⑦ - GND(Switch power output) ⑧ - GND(Cab light)	20~25V

※ GND : Ground

WIPER AND WASHER CIRCUIT

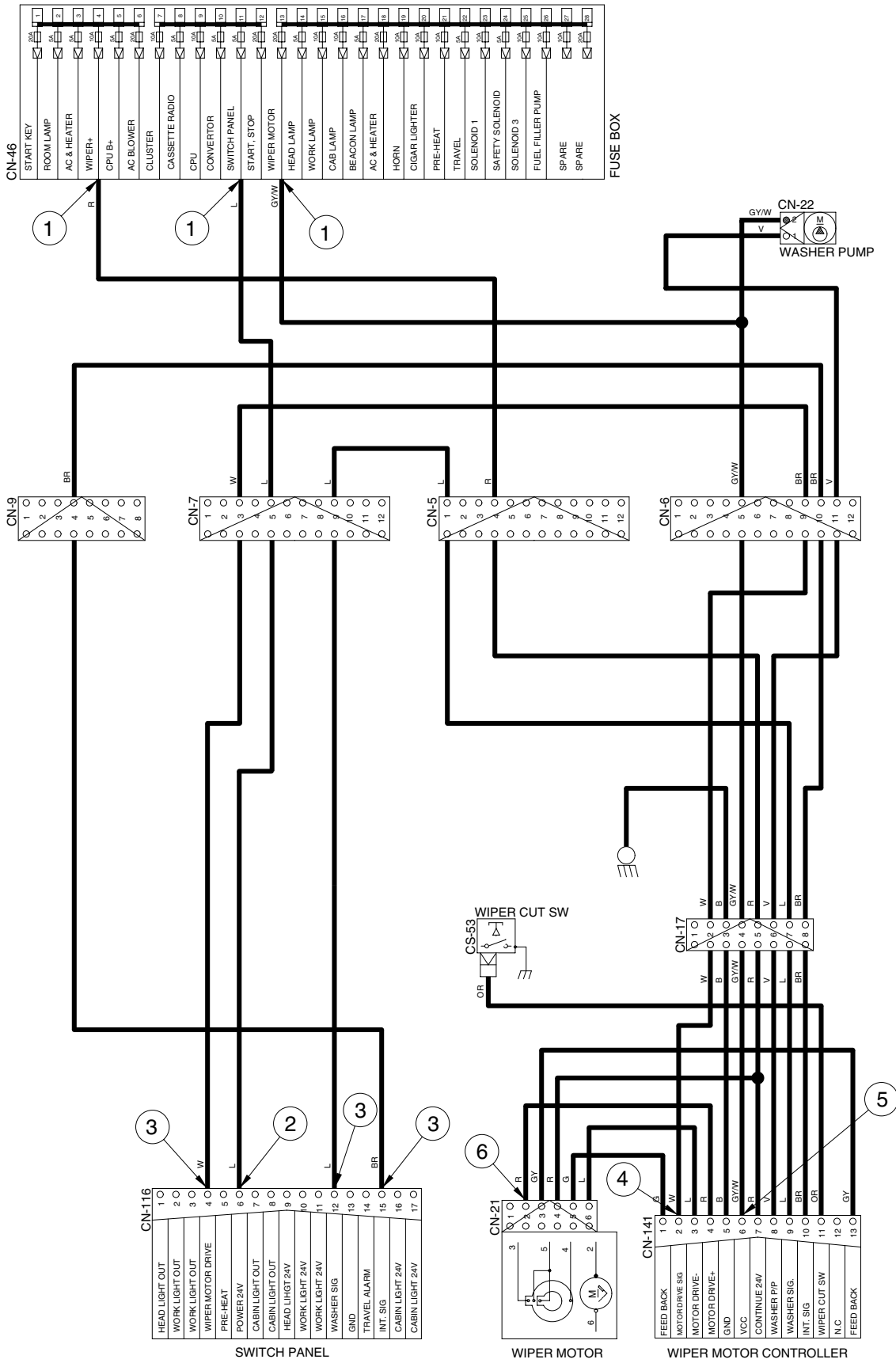

CONTROLLER CIRCUIT

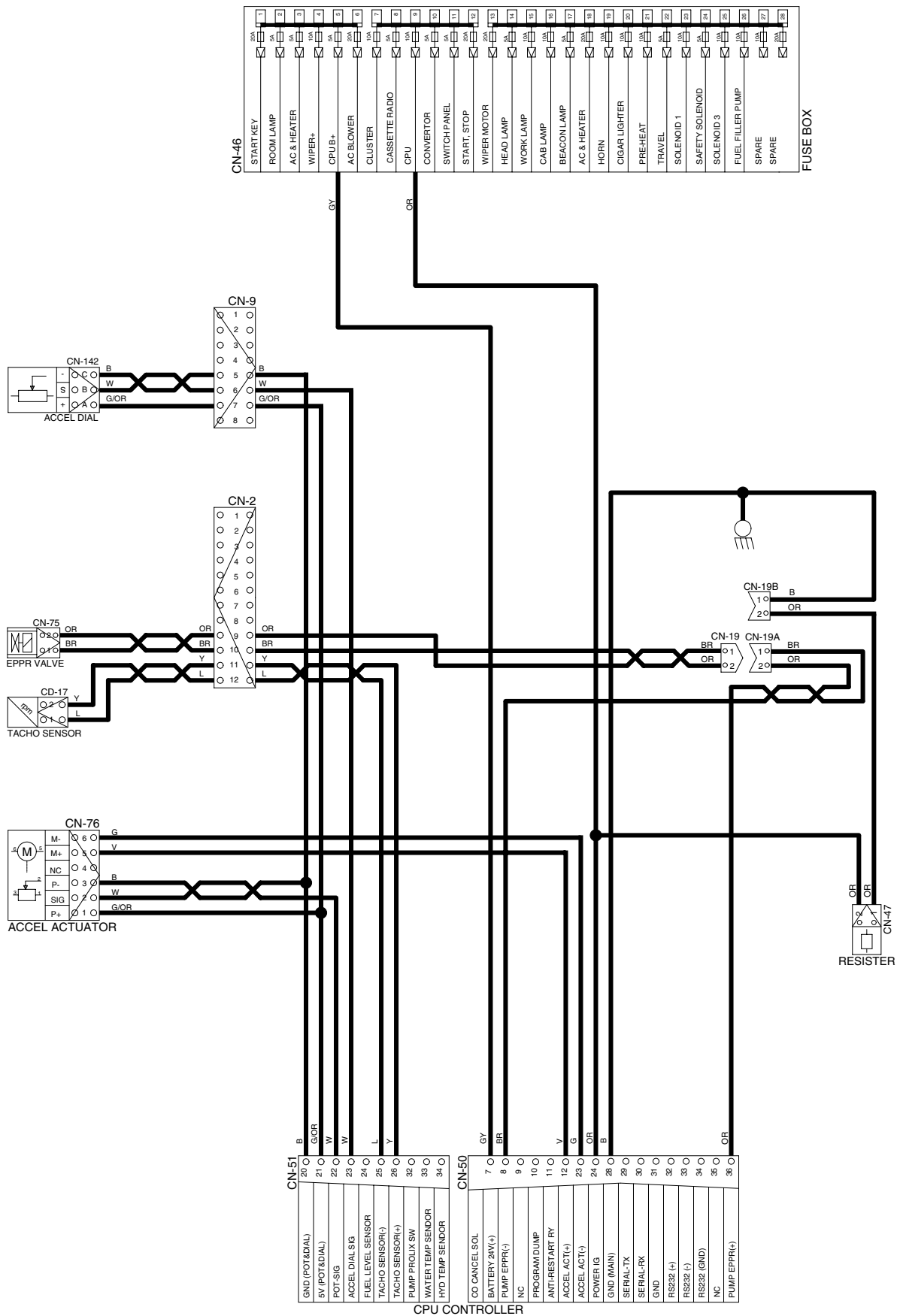

ELECTRIC CIRCUIT FOR HYDRAULIC

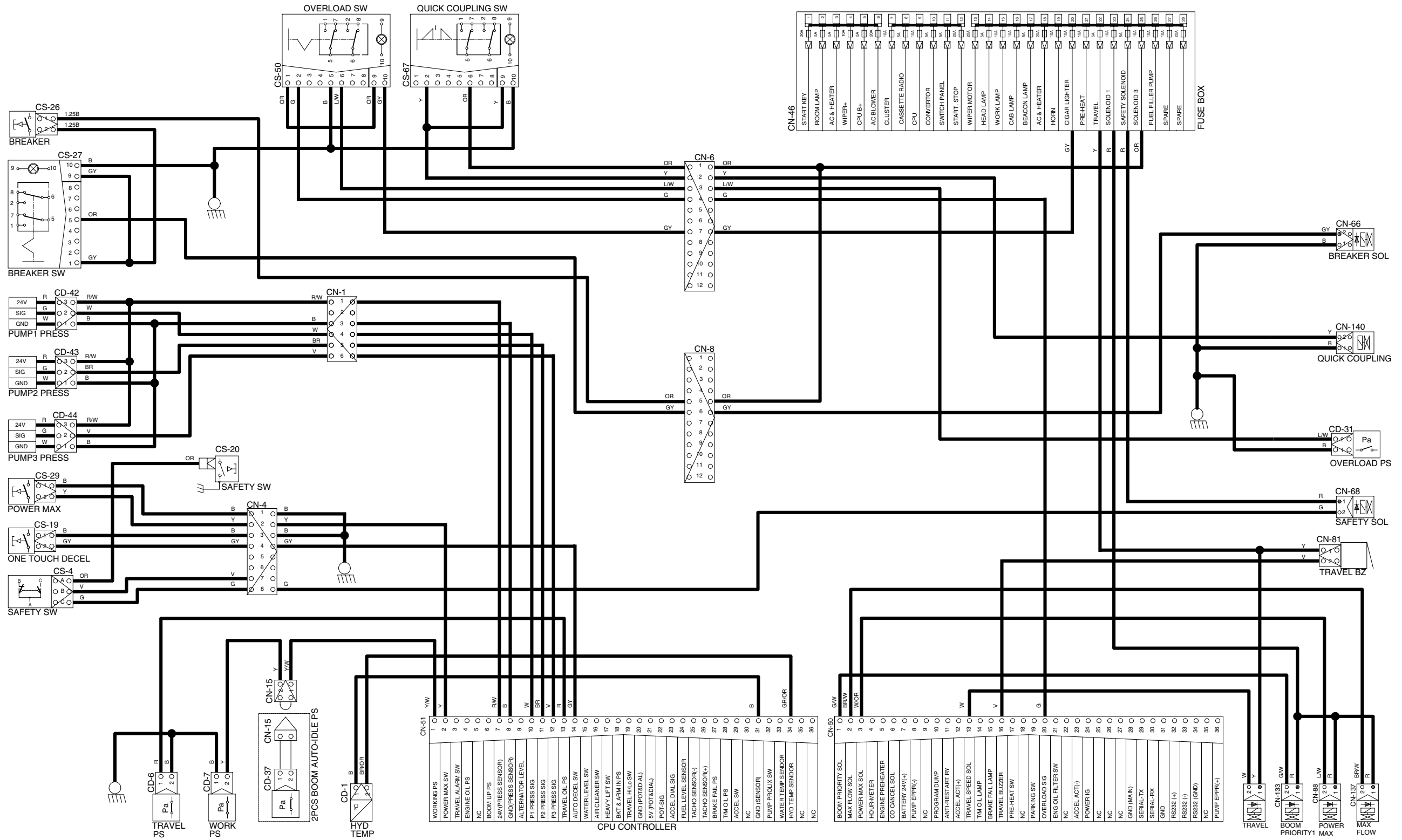

MONITORING CIRCUIT

