

GROUP 6 TRAVEL DEVICE (TYPE 1)

1. REMOVAL AND INSTALL

1) REMOVAL

- (1) Swing the work equipment 90 ° and lower it completely to the ground.
- (2) Operate the control levers and pedals several times to release the remaining pressure in the hydraulic piping.
- (3) Loosen the breather slowly to release the pressure inside the hydraulic tank.

▲ Escaping fluid under pressure can penetrate the skin causing serious injury.

※ When pipes and hoses are disconnected, the oil inside the piping will flow out, so catch it in oil pan.

- (4) Remove the track shoe assembly.
For details, see **removal of track shoe assembly**.
- (5) Remove the cover.
- (6) Remove the hose.
※ Fit blind plugs to the disconnected hoses.
- (7) Remove the bolts and the sprocket.
- (8) Sling travel device assembly (1).
- (9) Remove the mounting bolts (2), then remove the travel device assembly.
· Weight : 305 kg (670 lb)

2) INSTALL

- (1) Carry out installation in the reverse order to removal.
- (2) Bleed the air from the travel motor.
 - ① Remove the air vent plug.
 - ② Pour in hydraulic oil until it overflows from the port.
 - ③ Tighten plug lightly.
 - ④ Start the engine, run at low idling, and check oil come out from plug.
 - ⑤ Tighten plug fully.
- (3) Confirm the hydraulic oil level and check the hydraulic oil leak or not.

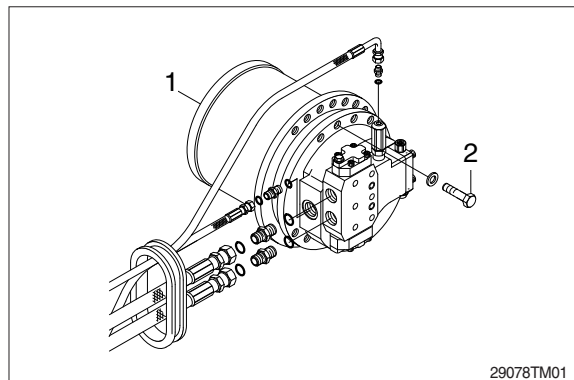

2. SPECIFICATION

1) TRAVEL MOTOR

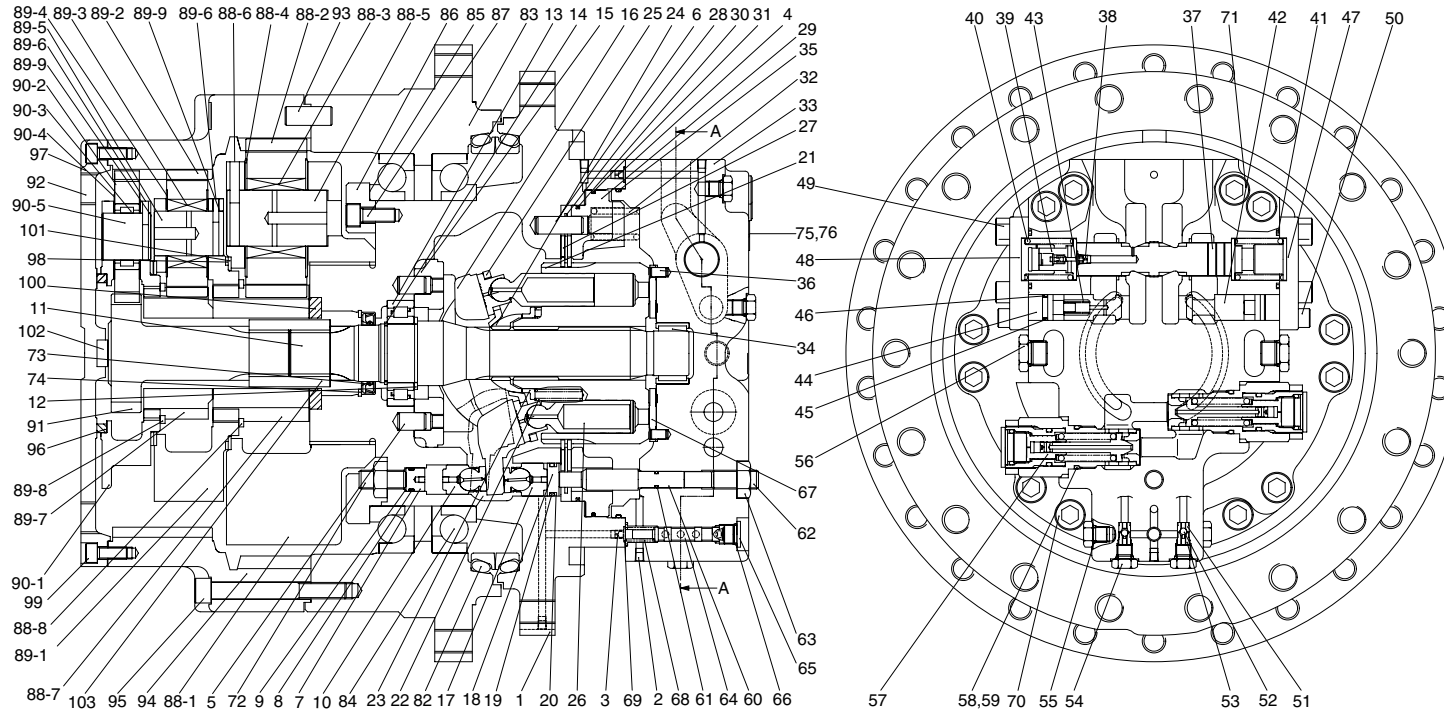

SECTION A-A

29092TM30

1 Casing	16 Plate	31 Ring	46 Back up ring	61 O-ring	83 Housing	89-1 Carrier No.2	91 Sun gear No.1
2 Plug	17 Piston	32 Spring	47 Cap	62 Lock screw	84 Bearing	89-2 Planetary gear No.2	92 Plug
3 Screw	18 Stopper	33 Valve casing	48 Cap	63 Nut	85 Shim	89-3 Needle No.2	93 Lock pin
4 Screw	19 O-ring	34 Needle bearing	49 Bolt	64 Spool	86 Retainer	89-4 Thrust washer No.2	94 Ring gear
5 Pin	20 Back up ring	35 O-ring	50 Socket bolt	65 Plug	87 Bolt	89-5 Pin No.2	95 Bolt
6 Pin	21 Cylinder block	36 Pin	51 Seat	66 O-ring	88 Carrier No.3	89-6 Spring pin No.2	96 Thrust ring No.1
7 Stopper	22 Cylinder spring	37 Spool	52 Steel ball	67 Valve plate	88-1 Carrier No.3	89-7 Sun gear No.2	97 Cover
8 O-ring	23 Spacer	38 Screw	53 Stopper	68 Spring	88-2 Planetary gear No.3	89-8 Snap ring No.2	98 Thrust ring No.2
9 Back up ring	24 Guide	39 Damping check	54 Plug	69 O-ring	88-3 Needle No.3	89-9 Spring pin No.2	99 Bolt
10 Piston	25 Plate	40 Spring	55 O-ring	70 Socket bolt	88-4 Thrust washer No.3	90 Carrier No.1	100 Motor ring
11 Shaft	26 Piston & Shoe assy	41 O-ring	56 Plug	71 Socket bolt	88-5 Pin No.3	90-1 Carrier No.1	101 Thrust ring No.3
12 Spacer	27 Plate	42 Plunger	57 Relief valve	72 Lock screw	88-6 Spring pin No.3	90-2 Planetary gear No.1	102 Pad
13 Roller bearing	28 Plate	43 Spring	58 O-ring	73 Oil seal	88-7 Sun gear No.3	90-3 Needle bearing No.1	103 Coupling
14 Stop ring	29 Brake	44 Stopper	59 Back up ring	74 Lock ring	88-8 Snap ring No.3	90-4 Thrust washer No.1	
15 Support	30 Ring	45 O-ring	60 Rod	82 Floating Seal	89 Carrier No.2	90-5 Pin No.1	

2) TOOL AND TIGHTENING TORQUE

(1) Tools

Name of tools	B-size	Name of part applied
Hexagonal L-Wrench	4	Plug (2), Orifice screw (3, 4, 38)
	8	Hex socket bolt (50), Lock screw (62, 72), Plug (65)
	10	Hex socket bolt (49)
	46	Hex (57)
Socket wrench/ spanner	19	Hp plug (54)
	24	Hex nut (63)
	27	Hp plug (56)
Snap-ring plier (for holes, axis)		Ring stop (14), Ring lock (74)
Solder hammer		Needle bearing (34), Pin (5, 6, 36)
Torque wrench		Size : 500, 3000
Jig for assembling oil seal		Oil seal (73)
Induction heating apparatus for bearing		Roller bearing (13)

(2) Tightening torque

NO.	Part name	Standard	Size	Torque	
				kgf · m	lbf · ft
2	Plug	NPTF 1/16	4	0.9±0.2	6.51±1.45
3, 4, 38	Orifice screw	NPTF 1/16	4	0.7	5.06
49	Hex socket bolt	M12	10	10	72.33
50	Hex socket bolt	M10	8	6.7	48.46
54	Plug	PF 1/4	19	3.7	26.76
56	Plug	PF 1/2	27	11	79.56
57	Relief valve	HEX 46	46	18±1.0	130±7.0
63	Nut	M16	24	24	173.59
65	Plug	PF 3/8	8	7.5	54.25
70, 72	Hex socket bolt	M16	14	24	173.59
71	Hex socket bolt	M16	14	24	173.59

2. DISASSEMBLING

1) GENERAL INSTRUCTIONS

- (1) Generally, hydraulic equipment is precisely manufactured and clearances between each parts are very narrow. Therefore, disassembling and assembling works should be performed on the clean place where dusts hardly gather. Tools and kerosene to wash parts should also be clean and handled with great care.
 - (2) When motor is removed from the host machine, wash around the ports sufficiently and put the plugs so that no dust and/or water may invade. Take off these plugs just before the piping works when re-attach it to the host machine.
 - (3) Before disassembling, review the sectional drawing and prepare the required parts, depending on the purpose and the range of disassembling.
Seals, O-rings, etc., if once disassembled, are not reusable.
There are some parts that should be replaced as a subassembly.
Consult with the parts manual in advance.
 - (4) The piston can be inserted to whichever cylinder block for the initial assembling.
However, their combination should not be changed if they are once used. To reuse them, put the matching mark on both pistons and cylinder block before disassembling.
- ▲ Take great care not to pinch your hand between parts while disassembling nor let fall parts on your foot while lifting them.**

2) DISASSEMBLING TRAVEL MOTOR

(1) Fix a hydraulic motor on jig with four pieces of bolts (M16×60L).

※ When rotating jig up to 90 ° in disassembling and assembling, fix a motor making drain plug (56) faced to the bottom.

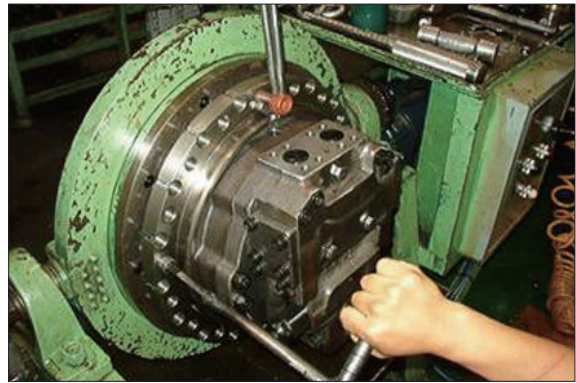

300072TM20

(2) After disassembling drain plug (56), let an oil in a case of a motor discharged.

※ Check whether manufactured chips or metal dust are added in a drain oil.



300072TM21

300072TM21A

(3) In order to making the out-put axis of a hydraulic motor faced upward, disassemble ring lock (74) with a plier after rotating jig up to 90 ° in disassembling and assembling.



300072TM22

(4) Disassemble hexagon socket bolts (70, 71) holding valve casing.

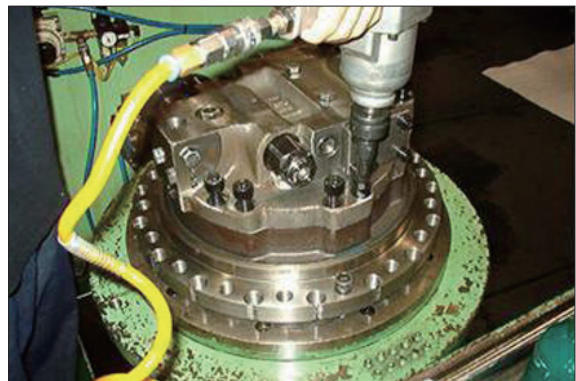

300072TM23

- (5) After detaching valve casing sub, disassemble valve plate (67).
 ※ In case of serious abrasion of valve plate, exchange it to a new one.

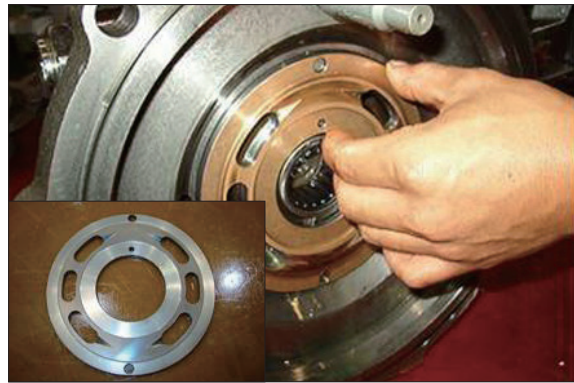

300072TM24A

300072TM24

- (6) After taking brake spring (32) and then bonding two pieces of M16 bolts to brake piston (29), disassemble it pulling it upward.
 ※ There are 10 pieces of brake spring.



300072TM25
 300072TM25A
 300072TM25B

- (7) First, rotate jig in disassembling and assembling up to 90 °, then let a motor faced toward the horizon. then disassemble a cylinder and piston sub.



300072TM26

- (8) disassemble stopper L (18) and piston swash (17).
 ※ Piston swash : Use M5 bolt



300072TM27

(9) Disassemble swash plate (16).



300072TM28

(10) After put M12 into support (15), disassemble support.

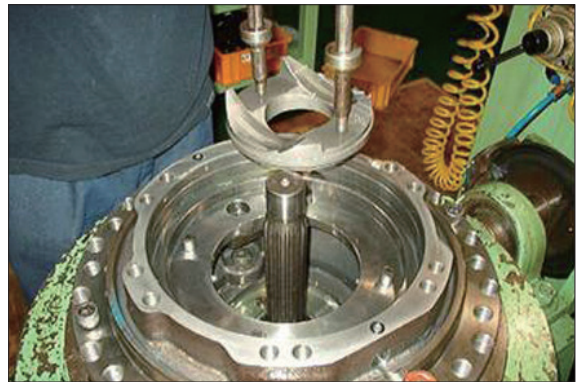

300072TM29

(11) disassemble piston swash (10) and stopper (7).



300072TM30

(12) In order to making the turning axis (11) faced upward, put it way from shaft casing tapping the bottom of the turning axis with hammer, after rotating jig up to 90 ° in disassembling and assembling.

※ Try to deal with roller bearing (13) without any damage.



300072TM31

(13) Disassemble valve casing sub.

※ Try to deal with needle bearing (3) without any damage.

① Disassemble plowing road (60), automatic changeover spring (68), and automatic changeover spool (64).

※ Do not touch hexagon nut (63) for controlling the amount of an oil and lock screw (62).

If there is any abnormality on plowing spool and spring, exchange them to new ones.

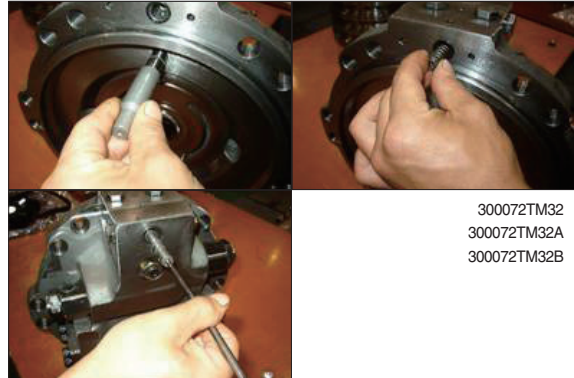

② After unloading hexagon socket bolts (49, 50) and taking caps (47,48) away, disassemble parts of counter balance valve (37~46).

※ In disassembling counter balance valve, be careful of figuring out the directions such as the right or the left of finger.

If there is any abnormality in spool spring check, exchange it to new one.



(14) Disassemble cylinder sub.

- ① Disassemble set plate (25) and piston (26) sub.



300072TM34

- ② Disassemble friction plate (27) and lee plate (28) in cylinder block (21).



300072TM35

- ③ Dismantle ball guide (24), spacer (23), and cylinder spring (22).

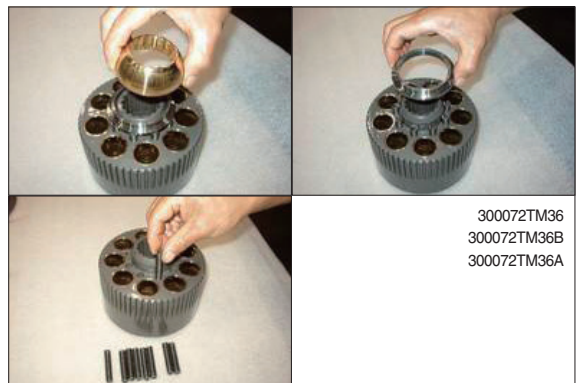

300072TM36
300072TM36B
300072TM36A

3) ASSEMBLING TRAVEL MOTOR

(1) Assemble the sub of a turning axis.

① After assembling bearing spacer (12) into a turning axis (11), have cylinder roller bearing (13) thermal-reacted.

a. In the thermal reaction of cylinder roller bearing, use an induction heating apparatus and adjust the temperature as about 100°C.

b. Deal moisturized copper part oil seal in a turning axis without any damage of it.



(2) Assemble ring stop (14) with a plier.

※ Be careful of the direction of ring stop.

(The direction of round is the side of bearing)



300072TM52

(3) Assemble valve casing sub.

① Bond seven pieces of plug (2) in valve casing (33) with standard torque.

② After taping plug with seal taper and spread rock tight, assemble it.

· Tightening torque : 7~11 kgf · m
(50.63~79.5 lbf · ft)

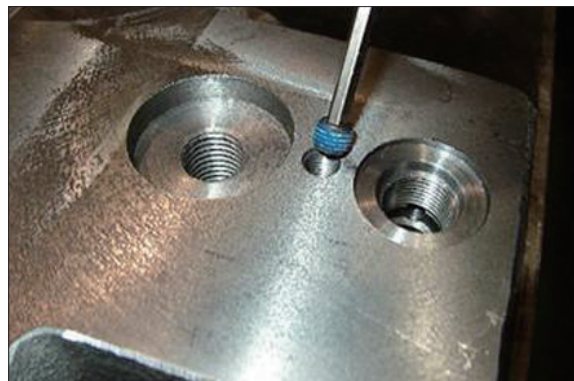

300072TM53

(4) Compress pin (36) into.

- ※ Using a hammer, make the height of pin 5mm from the a contact surface of valve plate.



300072TM54

(5) Assemble needle bearing (34).



300072TM55

(6) Assemble seat (51), ball (52), stopper (53), and hp plug (54) with O-ring (55), respectively.

- ① Be careful of the procedure and direction of assembling seat and stopper.

- Tightening torque : 37 kgf · m
(267.6 lbf · ft)



300072TM56

300072TM56A

(7) Assemble hp plug (54) set up with O-ring (55).

- 5sites
- Tightening torque : 37 kgf · m
(267.6 lbf · ft)

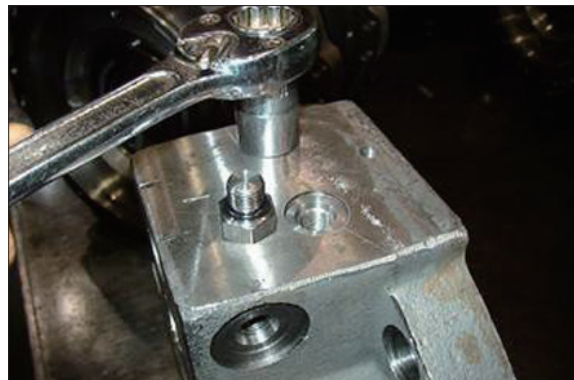

300072TM57

(8) Bond orifice screw (38) on the right and left side of spool c.b (37) with a standard torque.

- Tightening torque : 7 kgf · m (50.63 lbf · ft)

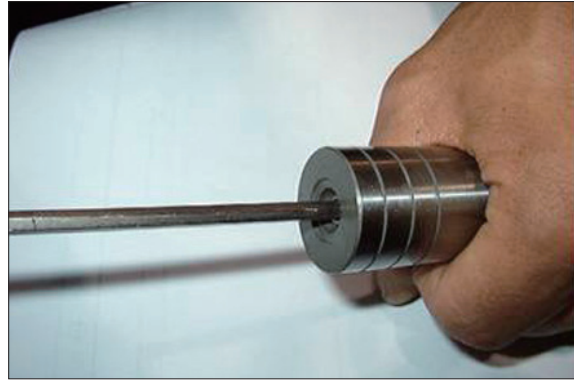

300072TM58

(9) Insert hold spool c.b (37) and damper check (39) into valve casing.

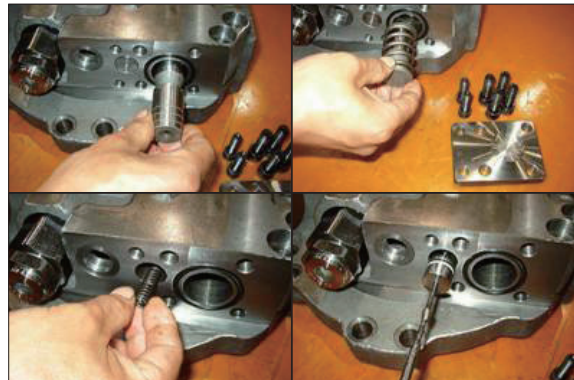

300072TM59
300072TM59B

300072TM59A
300072TM59C

(10) Bond cap R (47) and cap L (48) with hexagon socket bolts (49, 50).

① Remember not to exchange cap R, L each other in assembling.

Tightening torque

- M12 : 100 kgf · m (item 49)
- M10 : 67 kgf · m (item 50)

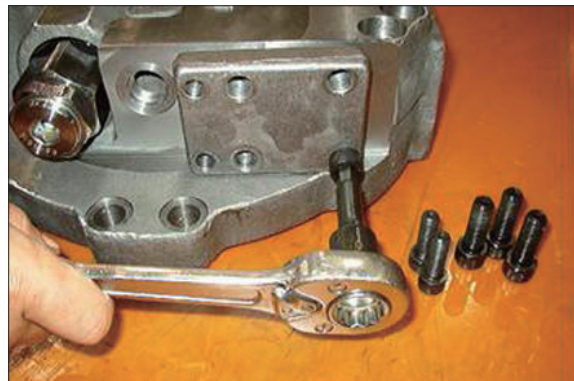

300072TM60

(11) After fastening with torque, insert automatic plowing spool (04), spring (68) and O-ring (69).

- Tightening torque : 75 kgf · m
(542.4 lbf · ft)



300072TM61

300072TM61A

(12) Assemble swash road (60) inserted by O-ring (61).



300072TM62

(13) Insert O-ring (32) into valve casing.

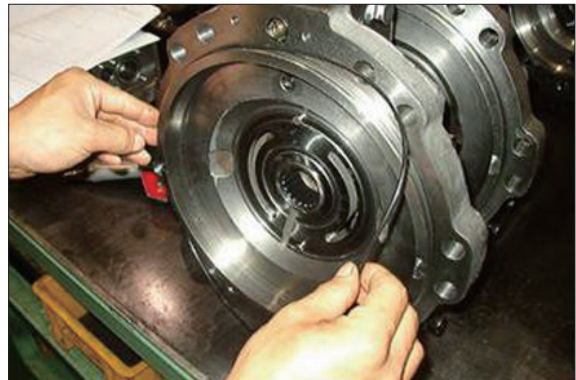

300072TM63

(14) Bond drain plug (30) inserted by O-ring (31) with standard torque.

- Tightening torque : 100 kgf · m
(723.3 lbf · ft)



300072TM64

(15) Assemble cylinder sub.

① Assemble cylinder spring (22), spacer (23), and spherical surface bush (24) into cylinder (21).

Set the position of spline of spherical surface bush and cylinder.

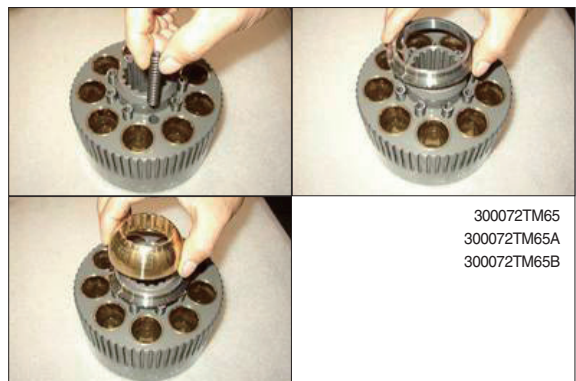

300072TM65
300072TM65A
300072TM65B

(16) Assemble friction plate (27) and separated plate (28) into cylinder.



300072TM66

(17) After insert piston shoe (26) into set plate (25), assemble it into cylinder.



300072TM67

300072TM67A

(18) Using jig, compress oil seal (73) into shaft casing (01).



300072TM68

(19) Assemble the body of a motor.

① Bond seven piece of plug (02) in shaft casing plug with standard torque.

a. After taping plug with seal taper and spread rock tight, assemble it.

· Tightening torque : 7~11 kgf · m
(50.63~79.5 lbf · ft)



300072TM69

300072TM69A

(20) Using a hammer and a handle, compress pin (5, 6).

① Pin(5) : Set the height as 10mm from the contact surface of a plate supporter. - 2pieces.

Pin(6) : Set the height as 19mm from the manufactured surface of shaft casing. - 4pieces.



300072TM70

300072TM70A

(21) Assemble sub of a turning axis.



300072TM71

(22) Assemble plate supporter (15) with M12 bolt.

※ Be careful of the direction of plate supporter driven.



300072TM72

(23) Assemble plate (16) into plate supporter.

① Spread grease in moisturized copper part of plate.

② Confirm the soft movement of plate.



300072TM73

(24) Assemble stopper L (36) combined by plowing piston (35) and O-ring (42).



(25) Rotating dismantling and assembling jig up to 90 ° make shaft from perpendicular to horizontal.

※ Be careful that plate is not segregated from plate supporter.

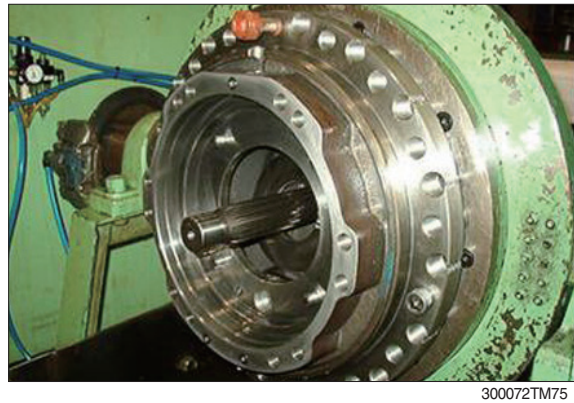

(26) Assemble cylinder sub.

※ Adjusting pin into holes of separated plate, assemble it.

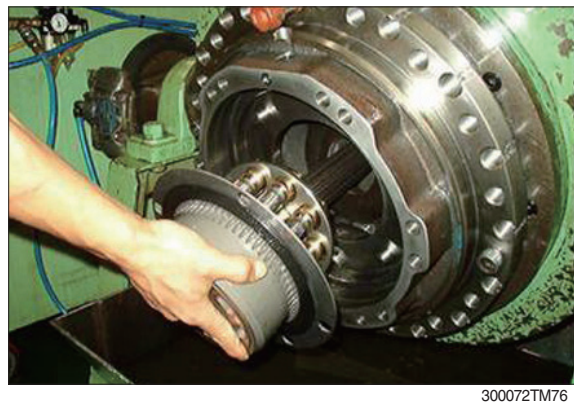

(27) Rotating dismantling and assembling jig up to 90 °, make the direction of shaft from the horizon to the perpendicular.



(28) Assemble piston ring (30), piston ring 252 (30) and 278 (31) into brake piston (29).



300072TM78

(29) Assemble brake piston into shaft casing.
※ Be careful of the direction of assembling brake piston.



300072TM79

(30) Assemble brake spring (32).
※ Quantity : Spring-10pieces, Holes-11pieces
※ Do not assemble on the top of brake piston.



300072TM80

(31) Insert O-ring (69), after fastening orifice screw (4) with standard torque.
· Quantity and size : (4) 2 pieces- \varnothing 1.0
(56) 1pieces- \varnothing 1.5
· Tightening torque : 7 kgf · m (50.63 lbf · ft)



300072TM81

(32)After inserting valve plate (67) into valve casing, bond it into shaft casing with hexagon socket bolt (70).

- ① Spread grease on the back side of valve plate, in order for valve plate to be adhered well.
- ② Use a crane in assembling it into valve plate shaft casing.
- ③ Set holes, $\varnothing 5$, of valve plate heading toward the port of the inlet and outlet of valve casing.
- ④ Spread grease in the side of plowing spool of plowing spring in order that plowing spring can not be detached.
 - Tightening torque : 240 kgf · m
(1736 lbf · ft)
 - Tightening torque : 180 ± 10 kgf · m
(1302 ± 72.3 lbf · ft)



300072TM82

(33)Bond relief valve (57) with standard torque.

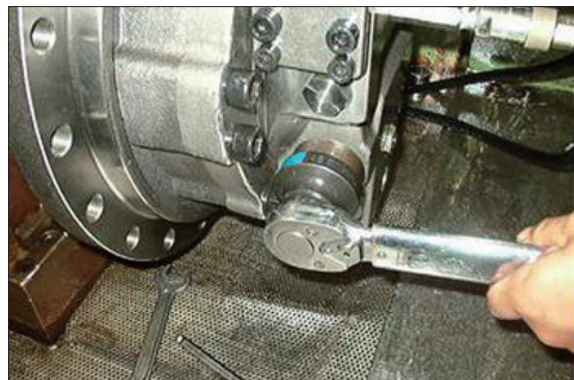

300072TM83

(34)Unloosen four pieces of bolts (M20×50L) fixing a motor and remove the motor away from jig.



300072TM84

3. DISASSEMBLING REDUCTION UNIT

1) Preparation for disassembling

(1) The reduction units removed from excavator are usually covered with mud. Wash outside of propelling unit and dry it.

(2) Locate reducer in order for drain port to be at the lowest level loosen taper screw plug of drain port, and drain oil from reduction gear.

※ While oil is still hot, inside of the unit may be pressurized.

▲ Take care of the hot oil gushing out of the unit when loosening the plug.

(3) Mark for mating

Put marks on each mating parts when disassembling so as to reassemble correctly as before.

2) Setting reduction unit (or whole propelling unit) on work stand for disassembling

(1) Remove hexagon socket head bolts (M10, 19) at 3 places from cover (17) almost equally each other, and then install eye bolts (M10).

Lift up the unit using them and place it on work stand with cover upward.

※ Take great care not to pinch your hand between parts while disassembling nor let fall parts on your foot while lifting them.

3) Removing cover

(1) Remove the rest of hexagon socket head bolts (M10, 19) that secure ring gear. Loosen all the socket bolts and then, disassemble cover.

(2) As the cover (17) is adhered to ring gear (14), disassemble ring gear (14) and cover (17) by lightly hammering slantwise upward using sharpened punch inserted between the cover and ring gear.



300078RD01

4) Removing NO.1 carrier sub assy

(1) Remove No.1 sun gear

- ※ Be sure to maintain it vertical with the ground when disassembling No.1 sun gear.



300078RD02

- (2) Screw three eye bolt (M10, 15) in No.1 carrier and lift up and remove No.1 carrier assy.



300078RD03

5) Removing No. 2 carrier sub assy

(1) Remove No.2 sun gear

- ※ Be sure to maintain it vertical with the ground when disassembling No.2 sun gear.



300078RD04

- (2) Screw three M10 eye bolt in No.2 carrier and lift up and remove No.2 carrier assy.



300078RD05

6) Removing ring gear

- (1) Remove hexagon socket head bolts (M14, 15) that secure ring gear and housing.

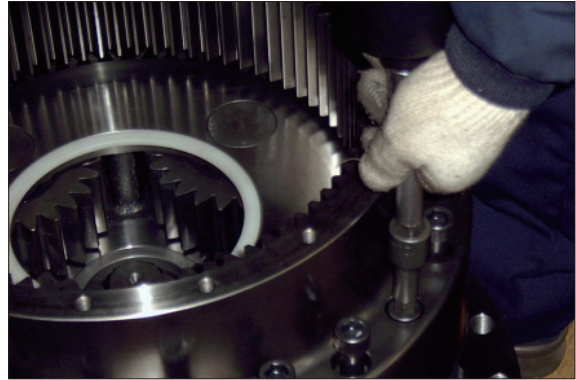

300078RD06

- (2) As the ring gear (14) is adhered to housing (3), disassemble ring gear (14) and housing (3) by lightly hammering slantwise upward using sharpen punch inserted between the ring gear and housing.

※ Carefully disassembling ring gear not to make scratch on it.

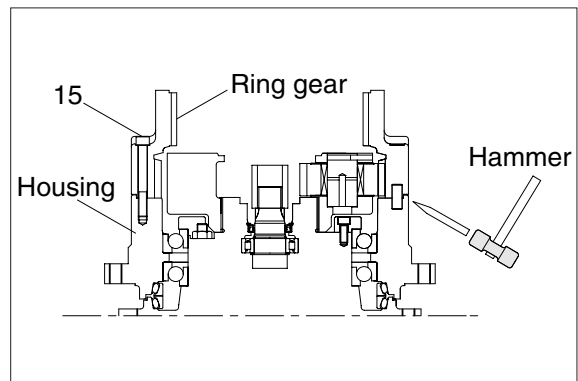

2907A8RD01

- (3) Screw three eye bolt (M10) in ring gear and lift up and remove it.

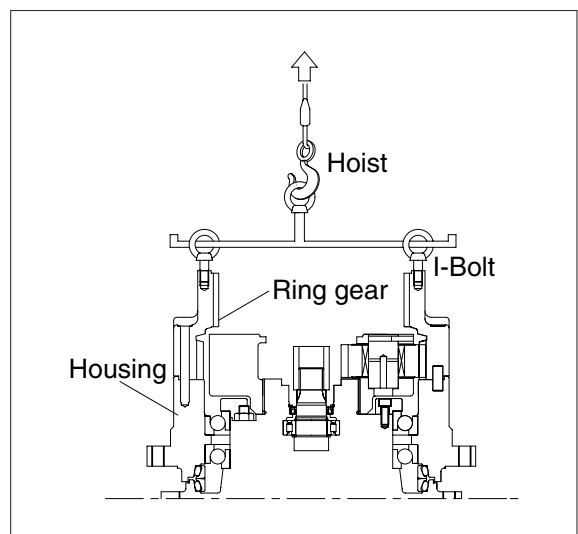

2907A8RD02

7) Remove No.3 carrier sub assy

(1) Removing No.3 sun gear

※ Be sure to maintain it vertical with the ground when disassembling No.3 sun gear.



300078RD09

(2) Screw three eye bolt(M10) in No.3 carrier and lift up and remove No.3 carrier assy.

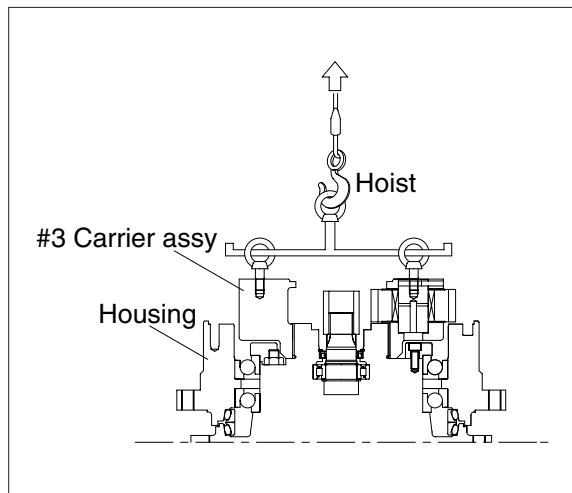

2907A8RD03

8) Remove coupling

(1) Remove coupling

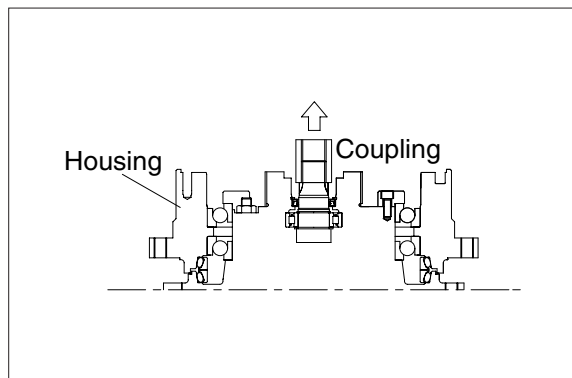

2907A8RD04

9) Remove motor ring

- (1) Remove motor ring using hand.



300078RD12

10) Removing retainer & shim

- (1) Remove hexagon socket (M12) head bolts that retainer and motor.
- (2) Remove retainer & shim.

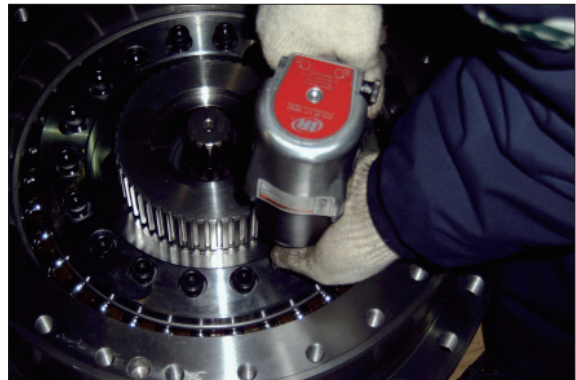

300078RD13

11) Removing housing sub assy

- (1) Screw eye bolt (M14) in housing and lift up housing assembly including angular bearing and floating seal.

12) Removing floating seal

- (1) Lift up a piece of floating seal of motor side.

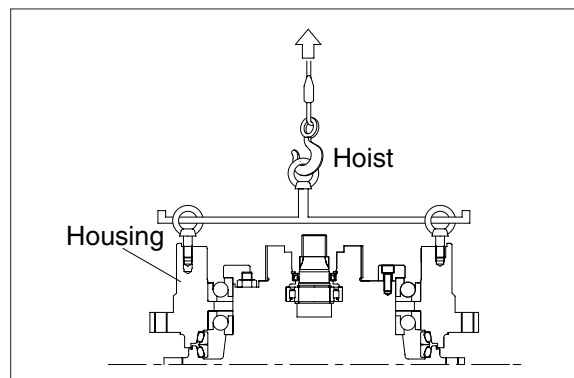

2907A8RD05

13) Disassembling housing assembly

- (1) After turning housing, lift up a piece of floating seal from housing and then remove it.
- ※ Don't disassemble angular bearing.



300078RD15

14) Disassembling No.1 carrier

- (1) Remove thrust ring (16) from carrier.
- (2) Knock spring pin (89-6) fully into No.1 pin (90-5).
- (3) Remove planetary, thrust washer, No.1 pin, bearing from carrier.

15) Disassembling No.2,3 carrier

- (1) Disassemble (14) carriers, using the same method for No.1 carrier assembly.

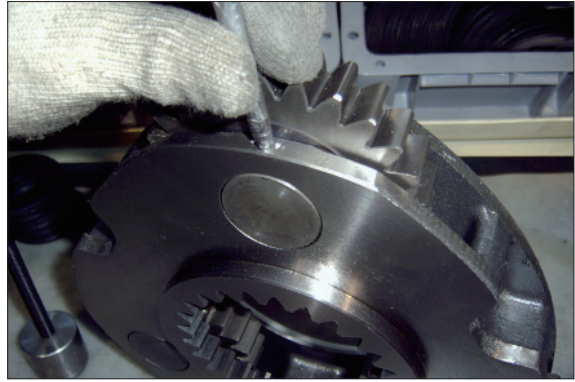

300078RD15

6. ASSEMBLING REDUCTION GEAR

- General precautions

Clean every part by kerosene and dry them by air blow.

Surfaces to be applied by locktite must be decreased by solvent.

Check every part for any abnormalities.

Each hexagon socket head bolt should be used with locktite No. 242 applied on its threads.

Apply gear oil slightly on each part before assembling.

Take great care not to pinch your hand between parts or tools while assembling nor let fall parts on your foot while lifting them.

Inspection before reassembling

Thrust washer

- Check if there are seizure, abnormal wear or uneven wear.
- Check if wear is over the allowable limit.

Gears

- Check if there are pitting or seizure on the tooth surface.
- Check if there are cracks on the root of tooth by die check.

Bearings

- Rotate by hand to see if there are something unusual such as noise or uneven rotation.

Floating seal

- Check flaw or score on sliding surface or on O-rings.

1) Assembling No.1 carrier

- (1) Put No.1 carrier (90-1) on a flat place.
- (2) Install No.1 needle bearing (90-3) into No.1 planetary gear (90-2), put 2 ea of No.1 thrust washer (90-4) on both sides of bearing, and then install it into carrier.
- (3) Install No.1 pin (90-5) into No.1 carrier where the holes for No.1 pin (90-5) are to be in line with those of No.1 carrier, and then, install spring pins into the holes.
- (4) Caulk carrier holes as shown on the picture.
- (5) Assembly ring thrust (96) into carrier.

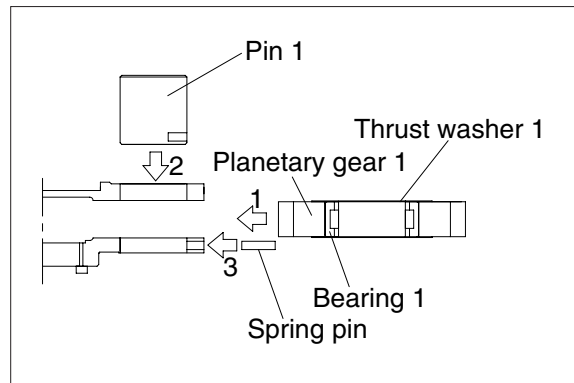

2907A8RD06



300078RD15

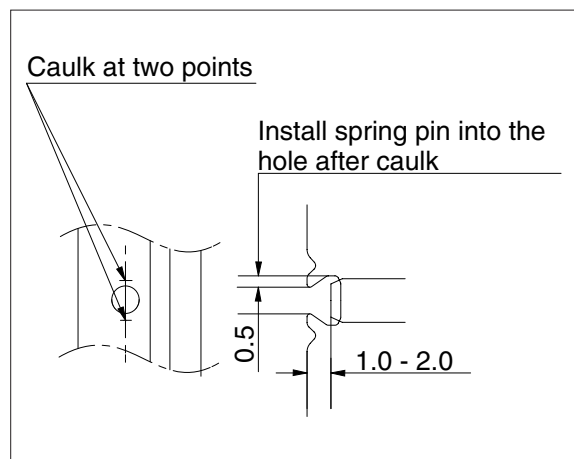

2907A8RD19

2) Assembling No.2 carrier

- (1) Make No.2 planetary gear (89-2) vertical, assemble 8-9 ea of No.2 needle (89-3), and then, assemble the remaining No.2 needle by use of the assembly jig for No.2 pin (89-5).
- (2) Remove out the assembly jig for No.2 pin and assemble 2 ea of No.2 thrust washer (89-4) into No.2 carrier (89-1).
- (3) Insert No.2 pin (89-5) into carrier where the holes of No.2 pin (89-5) are in line with those of carrier.
- (4) Hammer spring pin (89-6) to insert into carrier hole and No.2 pin hole, and then, caulk. Assemble 2 sets using the same method.
- (5) Assemble ring thrust (98) into carrier.

3) Assembling No.3 carrier

- (1) Assemble 4 sets, using the same method for assembly of No.2 carrier.

4) Installing floating seal

- (1) Assemble floating seal into motor by use of pressing jig.
- (2) Grease the contact parts for floating seal which is assembled into motor.

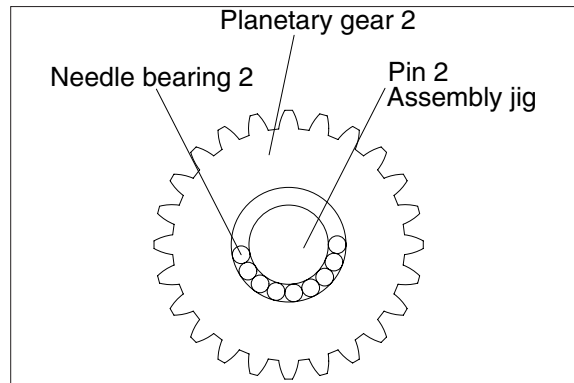

2907A8RD07

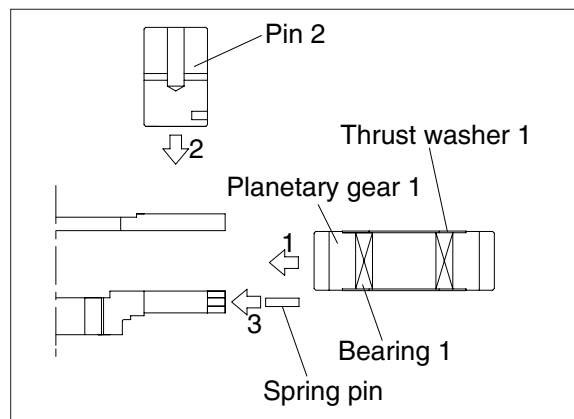

2907A8RD08

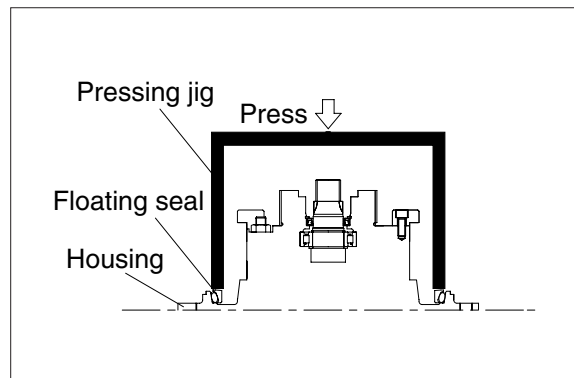

2907A8RD09



300078RD21

5) Assembling housing

- (1) Heat housing at 60~70 °C while clearing it out and then, assemble bearing.
 - (2) Assemble floating seal into housing by use of pressing jig as shown on the picture.
- ※ Be sure to maintain it vertical with the ground when assembling bearing and floating seal.

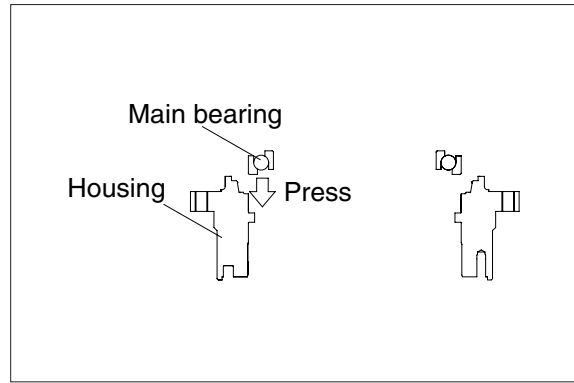

2907A8RD10

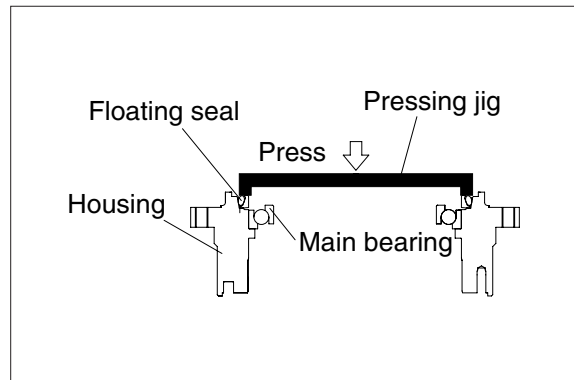

2907A8RD11

6) Installing housing assembly

- (1) Install 2 ea of eye bolt (M14) into housing assembly.
 - (2) Assemble housing into motor by use of hoist and eye bolt.
- ※ Be sure to tighten eye bolt deep enough.

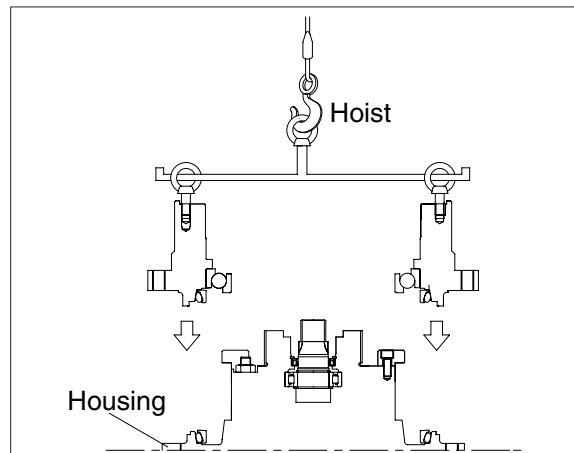

2907A8RD12

7) Installing main bearing

- (1) Heat main bearing at 60~70°C and then, install.
- ※ Be sure to maintain it vertical with the ground when assembling bearing.

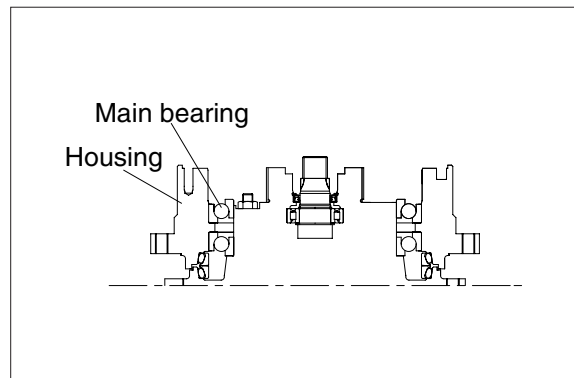

2907A8RD13

8) Installing retainer (86) and shim (85)

- (1) Measure clearance between main bearing and retainer by use of jig to decide the thickness of shim and select and appropriate shim, and then, assemble retainer.
- (2) Apply locktite (#242) on hexagon socket head bolt (M12), and then, bolt.

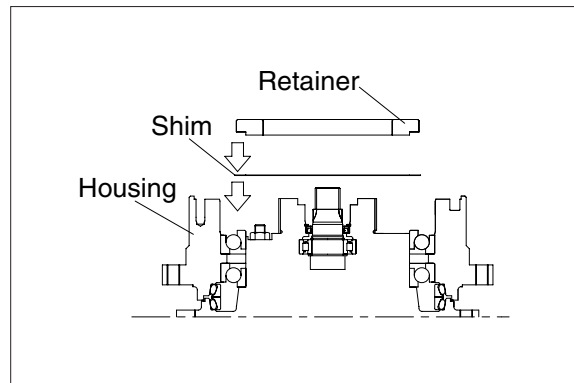

2907A8RD14



300078RD13

9) Installing motor ring

- (1) Insert motor ring into motor to install.

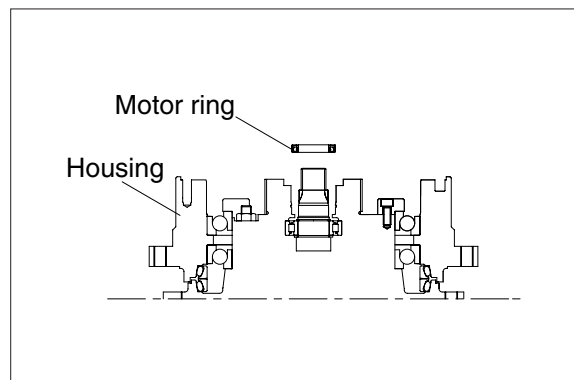

2907A8RD15

10) Installing coupling

- (1) Install coupling on spline of the motor.

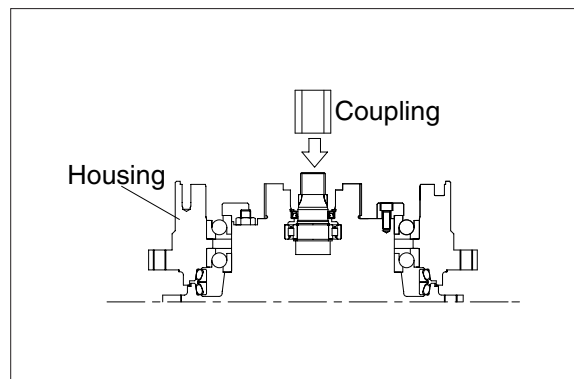

2907A8RD16

11) Installing No.3 carrier sub assy

- (1) Install eye bolt (M10) on No.3 carrier assembly.
 - (2) Lift No.3 carrier assembly and then, assemble it into reducer.
- ※ Match it vertical with the spline of the motor and the, slowly lower.

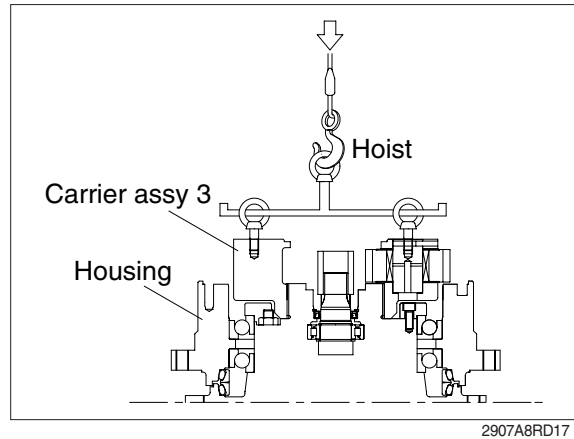

12) Installing ring gear

- (1) Apply three bond #1104 (Locktite #515) on housing for ring gear without gap.
- (2) Insert lock pin into housing hole.
- (3) Install eye bolt (M12) on the tap for cover of ring gear.
- (4) Lift ring gear and then, assemble into housing.
- (5) Apply locktite to hexagon socket bolt (M14) and then, bolt, having appropriate torque.

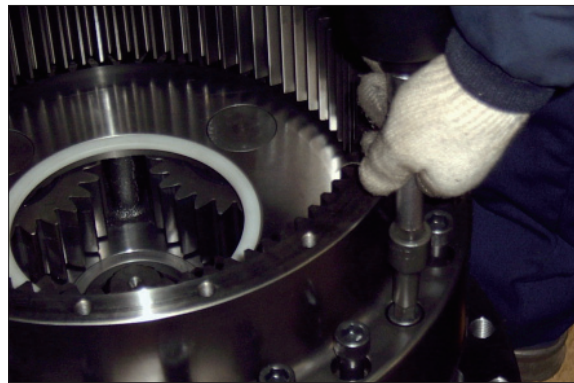
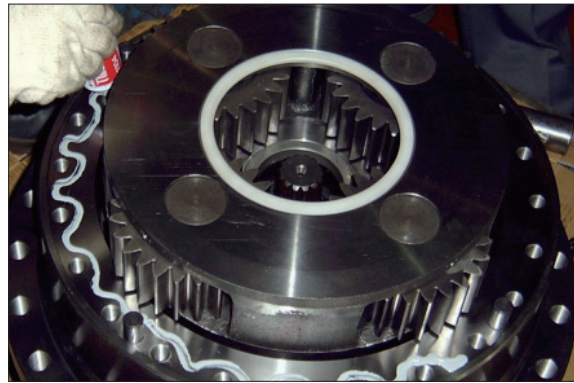

13) Installing No.3 sun gear (88-7)

- (1) Install snap ring (88-8) in No.3 sun gear (88-7) by use of snap ring pliers.
- (2) Install No.3 sun gear on the spline of No.3 carrier, matching teeth of them.

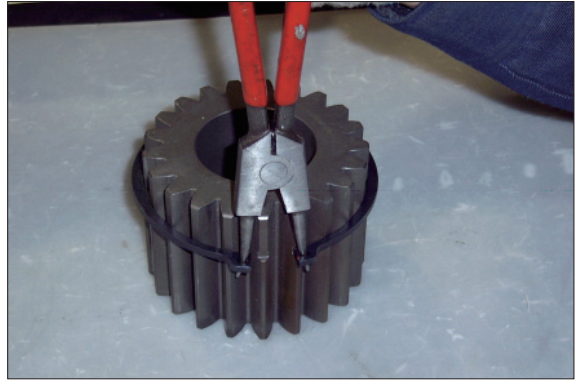

300078RD32



300078RD09

14) Installing No.2 carrier sub assy

- (1) Install eye bolt(M10) on No.2 carrier assembly.
- (2) Lift No.2 carrier assembly and then, slowly put it down on ring gear.
- (3) Rotate planetary gear by hands and install in ring gear.



300078RD05

15) Installing No.2 sun gear (89-7)

- (1) Install snap ring (89-8) on No.2 sun gear (89-7) by use of snap ring flier.
- (2) Install No.2 sun gear on the spline of No.2 carrier and No.2 planetary gear, matching teeth of them.

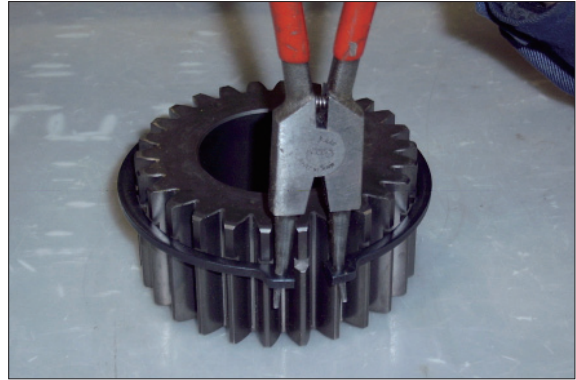

300078RD33



300078RD04

16) Installing No.1 carrier sub assy

- (1) Install eye bolt (M10) on No.1 carrier assembly.
- (2) Lift No.1 carrier assembly and then, put it down on ring gear slowly.
- (3) Rotate planetary gear by hands to install on ring gear, matching their teeth.



300078RD03

17) Installing No.1 sun gear (91)

- (1) Put down No.1 sun gear on No.1 carrier, maintaining it vertical with spline of coupling.
- (2) Install No.1 sun gear on No.1 planetary gear, matching their teeth.



300078RD02

18) Installing cover (97)

- (1) Beat pad with plastic hammer, and press it into the center of cover.
- (2) Apply three bond #104 (locktite #515) on the ring gear for without gap.
- (3) Put cover on ring gear, apply locktite (#242) in hexagon socket head bolt (M10), and then, bolt.
- (4) Fill gear oil (8L) into drain port.
- (5) Apply sealing tape (teflon) on PT3/4 plug and then, bolt.

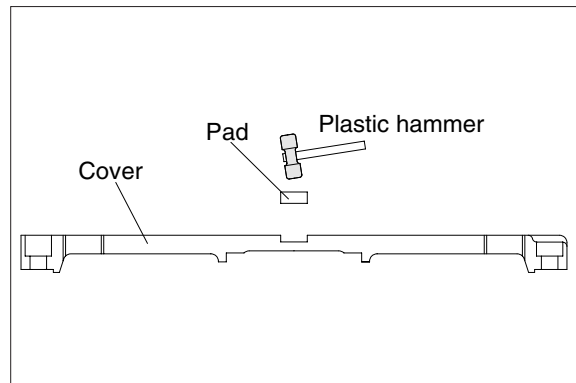

2908ARD18



300078RD35