

## GROUP 2 MAJOR COMPONENT

### 1. MAIN PUMP

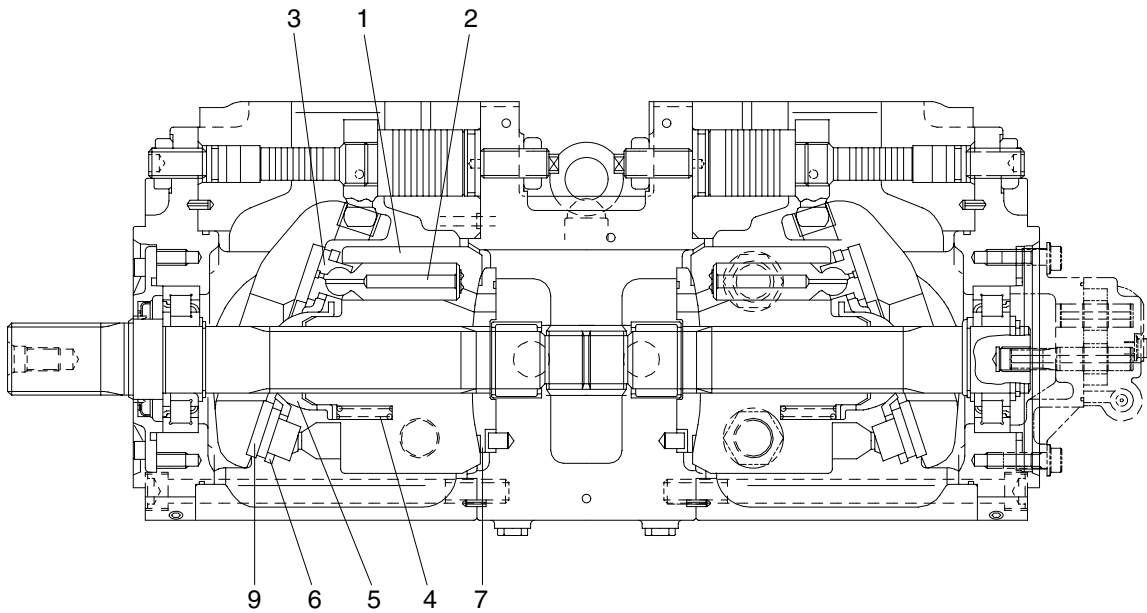

290LC7MS08

Part name & inspection item		Standard dimension	Recommended replacement value	Counter measures
Clearance between piston(1) & cylinder bore(2) (D-d)		0.043	0.070	Replace piston or cylinder.
Play between piston(1) & shoe caulking section(3) ( $\delta$ )		0-0.1	0.3	Replace assembly of piston & shoe.
Thickness of shoe (t)		5.4	5.0	
Free height of cylinder spring(4) (L)		47.9	47.1	Replace cylinder spring.
Combined height of set plate(5) & spherical bushing(6) (H-h)		23.8	22.8	Replace retainer or set plate.
Surface roughness for valve plate (sliding face) (7,8), swash plate (shoe plate area) (9), & cylinder(2) (sliding face)	Surface roughness necessary to be corrected	3z		Lapping
	Standard surface roughness (corrected value)	0.4z or lower		

## 2. MAIN CONTROL VALVE

Part name	Inspection item	Criteria & measure
Casing	<ul style="list-style-type: none"> <li>· Existence of scratch, rusting or corrosion.</li> </ul>	<ul style="list-style-type: none"> <li>· In case of damage in following section, replace part               <ul style="list-style-type: none"> <li>- Sliding sections of casing fore and spool, especially land sections applied with holding pressure</li> <li>- Seal pocket section where spool is inserted</li> <li>- Seal section of port where O-ring contacts</li> <li>- Seal section of each relief valve for main, travel, and port</li> <li>- Other damages that may damage normal functions</li> </ul> </li> </ul>
Spool	<ul style="list-style-type: none"> <li>· Existence of scratch, gnawing, rusting or corrosion.</li> <li>· Insert spool in casing hole, rotate and reciprocate it.</li> </ul>	<ul style="list-style-type: none"> <li>· Replacement when its outside sliding section has scratch (especially on seals contacting section)</li> <li>· Correction or replacement when O-ring is damaged or when spool does not move smoothly</li> </ul>
Load check valve	<ul style="list-style-type: none"> <li>· Damage of load check valve or spring</li> </ul>	<ul style="list-style-type: none"> <li>· Repair or replace of improper seat contact</li> </ul>
Around spring	<ul style="list-style-type: none"> <li>· Rusting, corrosion, deformation or breaking of spring, spring seat, plug or cover.</li> </ul>	<ul style="list-style-type: none"> <li>· Replacement for significant damage</li> </ul>
Around seal for spool	<ul style="list-style-type: none"> <li>· External oil leakage.</li> </ul>	<ul style="list-style-type: none"> <li>· Replacement</li> </ul>
Main relief valve, Over relief valve	<ul style="list-style-type: none"> <li>· External rusting or damage.</li> <li>· Contacting face of valve seat.</li> </ul>	<ul style="list-style-type: none"> <li>· Replacement</li> <li>· Replacement when damaged</li> </ul>

### 3. SWING DEVICE

#### 1) WEARING PARTS

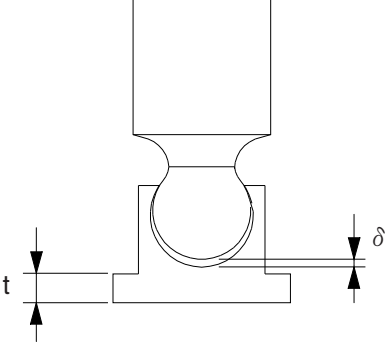
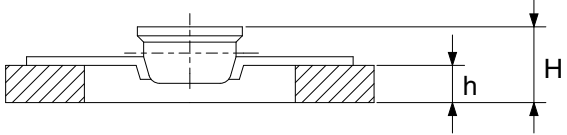
Inspection item	Standard dimension	Recommended replacement value	Counter measures
Clearance between piston and cylinder block bore	0.025	0.060	Replace piston or cylinder block
Play between piston and shoe caulking section ( $\delta$ )	0	0.3	Replace assembly of piston and shoe
Thickness of shoe (t)	8	7.7	Replace assembly of piston and shoe
Combined height of retainer plate and spherical bushing (H-h)	7.5	7.1	Replace set of retainer plate and spherical bushing
Thickness of friction plate	4.0	3.7	Replace
			

#### 2) SLIDING PARTS

Part name	Standard roughness	Allowable roughness	Remark
Shoe	0.8-Z (Ra=0.2) (LAPPING)	3-Z (Ra=0.8)	
Shoe plate	0.4-Z (Ra=0.1) (LAPPING)	3-Z (Ra=0.8)	
Cylinder	1.6-Z (Ra=0.4) (LAPPING)	12.5-Z (Ra=3.2)	
Valve plate	0.8-Z (Ra=0.2) (LAPPING)	6.3-Z (Ra=1.6)	

## 4. TRAVEL MOTOR

### 1) WEARING PARTS

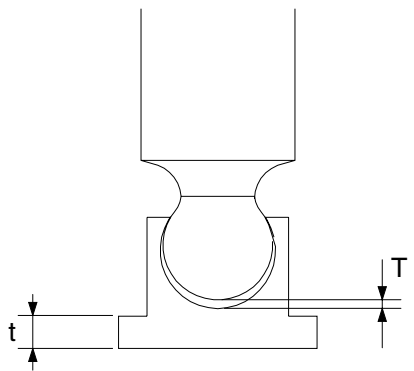
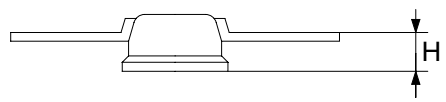
Inspection item	Standard dimension	Recommended replacement value	Counter measures
Clearance between piston and cylinder block bore	0.025	0.050	Replace piston or cylinder block
Play between piston and shoe caulking section(T)	0	0.3	Replace assembly of piston and shoe
Thickness of shoe(t)	4.5	4.3	Replace assembly of piston and shoe
Combined height of set plate and ball guide(H-h)	7.3	7.0	Replace set of set plate and ball guide
Thickness of friction plate	3.0	2.6	Replace
			

### 2) SLIDING PARTS

Part name	Standard roughness	Remark
Shoe	0.8S	-
Shoe plate	0.8S	-
Cylinder	0.8S	-
Valve plate	0.8S	-

## 5. TRAVEL REDUCTION GEAR

The followings are the general maintenance standards. However, it is most important to determine which parts should be replaced, depending on the characteristics shown before disassembling, damages or discoloration of exterior view, the purpose of disassembling, the expected remaining service life etc..

Item	Part name	Criteria	Allowable limit	Remedy
A	Wear of planetary shaft	Smooth, without abnormal wear or seizure	←	Replace 3 pieces as a set
B	Condition of tooth surface	Smooth, without abnormal wear or seizure	Not over 1.6 of pitching, no cracks at root	Replace 3 pieces as a set for planetary pinion
C	Thrust clearance of angular bearings (2)	-0.08~0.02 mm	←	Adjust shim thickness Refer to 8-101 (5)
D	Thickness of thrust washer 1 (18)	3.3~3.7 mm	Wear 0.1 mm	Replace
E	Thickness of thrust washer 2 (11)	5.3~5.7 mm	Wear 0.1 mm	Replace
F	Thickness of thrust plate (23)	4.34~4.66 mm	Wear 0.15 mm	Replace
G	Lubrication oil	2000 working hours (machine hour meter)		Replace

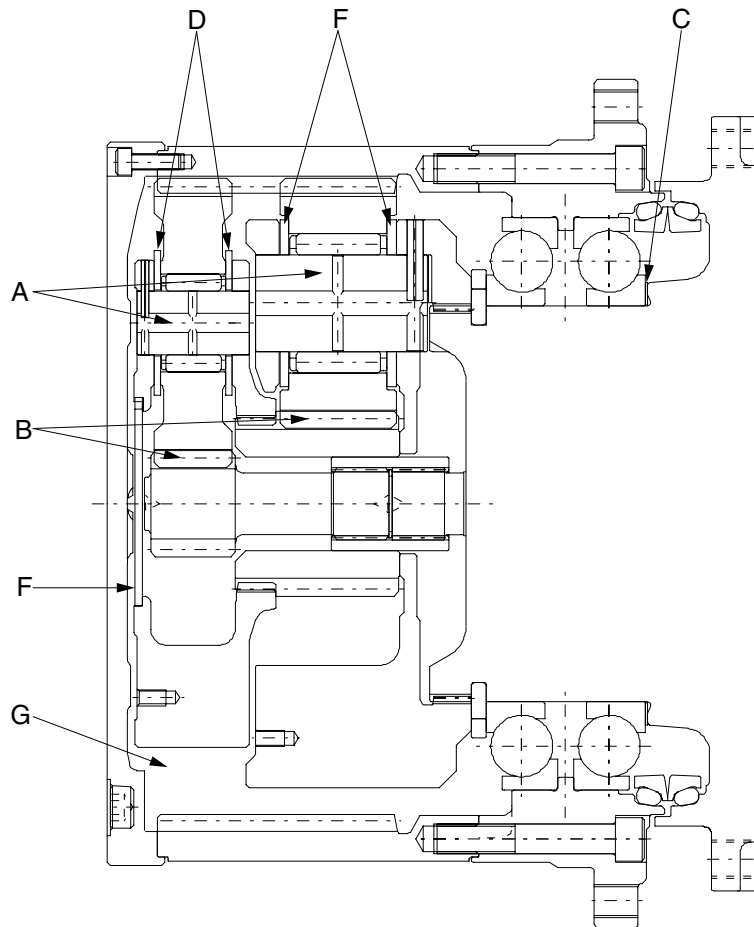

## 6. RCV LEVER

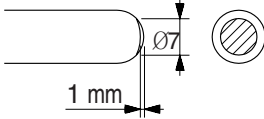
Maintenance check item	Criteria	Remark
Leakage	The valve is to be replaced when the leakage becomes more than 1000 cc/m at neutral handle position, or more than 2000 cc/m during operation.	Conditions : Primary pressure : 30 kgf/cm <sup>2</sup> Oil viscosity : 23 cSt
Spool	This is to be replaced when the sliding surface has worn more than 10 μm, compared with the non-sliding surface.	The leakage at the left condition is estimated to be nearly equal to the above leakage.
Push rod	 <p>This is to be replaced when the top end has worn more than 1 mm.</p>	
Play at operating section	The pin, shaft, and joint of the operating section are to be replaced when their plays become more than 2 mm due to wears or so on.	When a play is due to looseness of a tightened section, adjust it.
Operation stability	When abnormal noises, hunting, primary pressure drop, etc. are generated during operation, and these cannot be remedied, referring to section 6. Troubleshooting, replace the related parts.	

- Notes
1. It is desirable to replace seal materials, such as O-rings, every disassembling. However, they may be reused, after being confirmed to be free of damage.
  2. When loosening the hexagon socket head cap screw (125), replace the seal washers (121) without fail.

## 7. RCV PEDAL

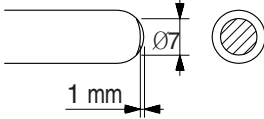
Maintenance check item	Criteria	Remark
Leakage	The valve is to be replaced when the leakage effect to the system. For example, the primary pressure drop.	Conditions : Primary pressure : 30 kgf/cm <sup>2</sup> Oil viscosity : 23 cSt
Spool	This is to be replaced when the sliding surface has worn more than 10 μm, compared with the non-sliding surface.	The leakage at the left condition is estimated to be nearly equal to the above leakage.
Push rod	 <p>This is to be replaced when the top end has worn more than 1 mm.</p>	
Play at operating section	The pin, shaft, and joint of the operating section are to be replaced when their plays become more than 2 mm due to wears or so on.	When a play is due to looseness of a tightened section, adjust it.
Operation stability	When abnormal noises, hunting, primary pressure drop, etc. are generated during operation, and these cannot be remedied, referring to section 6. Troubleshooting, replace the related parts.	

Notes 1. It is desirable to replace seal materials, such as O-rings, every disassembling. However, they may be reused, after being confirmed to be free of damage.

## 8. TURNING JOINT

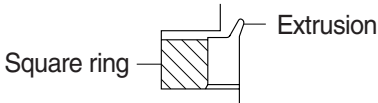
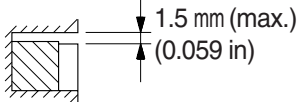
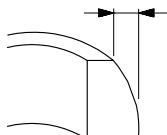
Part name		Maintenance standards	Remedy
Body, Stem	Sliding surface with sealing sections.	Plating worn or peeled due to seizure or contamination.	Replace
	Sliding surface between body and stem other than sealing section.	· Worn abnormality or damaged more than 0.1 mm (0.0039 in) in depth due to seizure contamination.	Replace
		· Damaged more than 0.1 mm (0.0039 in) in depth.	Smooth with oilstone.
	Sliding surface with thrust plate.	· Worn more than 0.5 mm (0.02 in) or abnormality.	Replace
		· Worn less than 0.5 mm (0.02 in).	Smooth
		· Damage due to seizure or contamination remediable within wear limit (0.5 mm) (0.02 in).	Smooth
Cover	Sliding surface with thrust plate.	· Worn more than 0.5 mm (0.02 in) or abnormality.	Replace
		· Worn less than 0.5 mm (0.02 in).	Smooth
		· Damage due to seizure or contamination remediable within wear limit (0.5 mm) (0.02 in).	Replace
Seal set	-	<ul style="list-style-type: none"> <li>· Extruded excessively from seal groove square ring.</li> </ul> 	Replace
	-	<ul style="list-style-type: none"> <li>· Slipper ring 1.5 mm (0.059 in) narrower than seal groove, or narrower than back ring.</li> </ul> 	Replace
	-	<ul style="list-style-type: none"> <li>· Worn more than 0.5 mm (0.02 in) ~ 1.5 mm (MAX.) (0.059 in)</li> </ul> 	Replace



## 9. CYLINDER

Part name	Inspecting section	Inspection item	Remedy
Piston rod	· Neck of rod pin	· Presence of crack	· Replace
	· Weld on rod hub	· Presence of crack	· Replace
	· Stepped part to which piston is attached.	· Presence of crack	· Replace
	· Threads	· Presence of crack	· Recondition or replace
	· Plated surface	· Plating is not worn off to base metal.	· Replace or replate
		· Rust is not present on plating. · Scratches are not present.	· Replace or replate · Recondition, replate or replace
	· Rod	· Wear of O.D.	· Recondition, replate or replace
· Bushing at mounting part	· Wear of I.D.	· Replace	
Cylinder tube	· Weld on bottom	· Presence of crack	· Replace
	· Weld on head	· Presence of crack	· Replace
	· Weld on hub	· Presence of crack	· Replace
	· Tube interior	· Presence of faults	· Replace if oil leak is seen
	· Bushing at mounting part	· Wear on inner surface	· Replace
Gland	· Bushing	· Flaw on inner surface	· Replace if flaw is deeper than coating