

GROUP 5 SWING DEVICE

1. REMOVAL AND INSTALL OF MOTOR

1) REMOVAL

(1) Lower the work equipment to the ground and stop the engine.

(2) Loosen the breather slowly to release the pressure inside the hydraulic tank.

▲ Escaping fluid under pressure can penetrate the skin causing serious injury.

※ When pipes and hoses are disconnected, the oil inside the piping will flow out, so catch it in oil pan.

(3) Disconnect pipe assy (2, 3).

(4) Disconnect pilot line hoses (4, 5, 6, 7, 8, 9).

(5) Sling the swing motor assembly (1) and remove the swing motor mounting bolts (10).

- Motor device weight : 65 kg (140 lb)
- Tightening torque : 58.4 kgf · m
(422.4 lbf · ft)

(6) Remove the swing motor assembly.

※ When removing the swing motor assembly, check that all the piping have been disconnected.

2) INSTALL

(1) Carry out installation in the reverse order to removal.

(2) Bleed the air from the swing motor.

- ① Remove the air vent plug.
- ② Pour in hydraulic oil until it over flows from the port.
- ③ Tighten plug lightly.
- ④ Start the engine, run at low idling, and check oil come out from plug.
- ⑤ Tighten plug fully.

(3) Confirmed the hydraulic oil level and check the hydraulic oil leak or not.

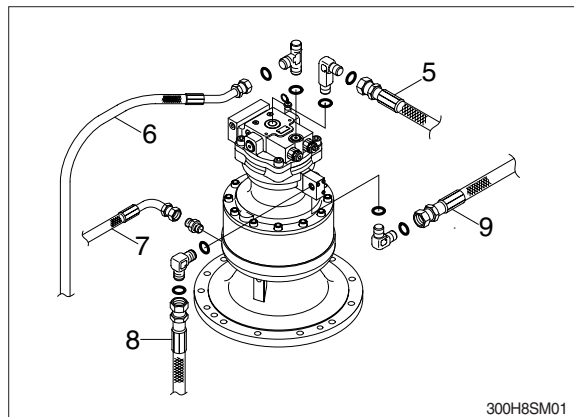
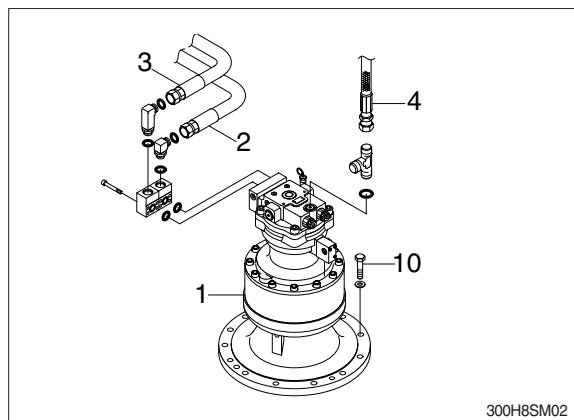

2. SWING MOTOR

1) STRUCTURE

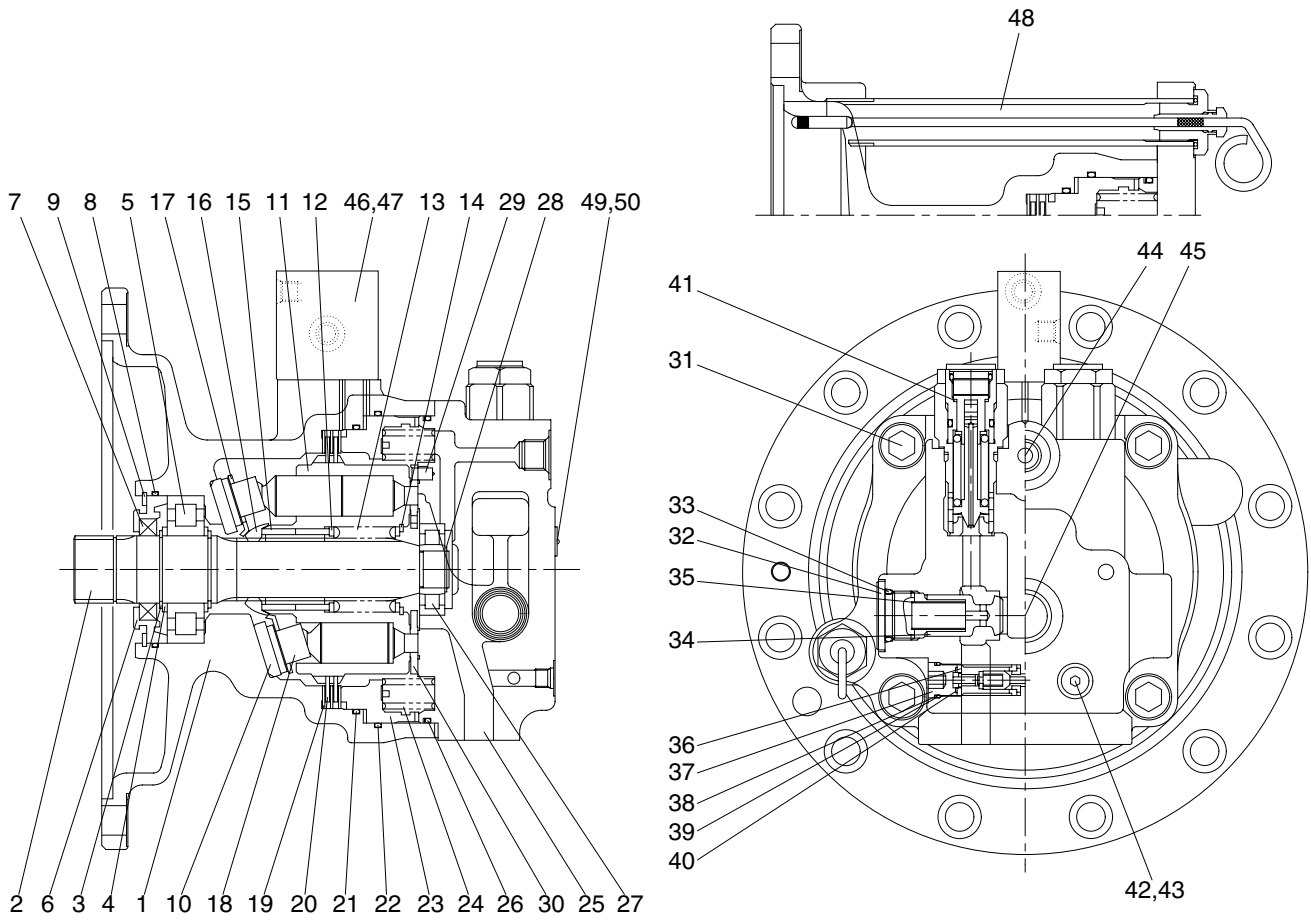

300H2SM02

1	Body	18	Piston	35	Spring
2	Shaft	19	Plate	36	Reaction less valve assy
3	Snap ring	20	Friction plate	37	Plug
4	Plate	21	O-ring	38	Back up ring
5	Roller bearing	22	O-ring	39	O-ring
6	Cover	23	Brake piston	40	O-ring
7	Oil seal	24	Spring	41	Relief valve assy
8	O-ring	25	Rear cover	42	Plug
9	Snap ring	26	O-ring	43	O-ring
10	Shoe plate	27	Roller bearing	44	Plug
11	Cylinder block	28	Snap ring	45	Plug
12	Spring seat	29	Pin	46	Time delay valve assy
13	Spring	30	Valve plate	47	Wrench bolt
14	Snap ring	31	Wrench bolt	48	Level gauge
15	Pin	32	Plug	49	Name plate
16	Ball guide	33	O-ring	50	Rivet
17	Set plate	34	Poppet		

2) TOOL AND TIGHTENING TORQUE

(1) Tools

Tool	Size B	Name of parts applied
Hexagonal L-wrench	5	Wrench bolt (47)
	6	Plug (42)
	10	Reverse prevention valve (36)
	12	Wrench bolt (31), Plug (32)
Socket wrench/Spanner	36	Relief valve assy (41)
Snap-ring plier (for holes, axis)		Snap ring
Hammer		Needle bearing (27), Ping (29)
Torque wrench		Relief valve assy (41), Body (1) & Rear cover (25), Removing wrench bolt (31, 47) (Tighten torque) · 1 ~ 4.5 kgf·m · 4 ~ 18 kgf·m · 12 ~ 48 kgf·m
Jig for oil seal assembly		Oil seal (7)
Heating tool for bearing		Roller bearing (5)
Brake piston removing tool		See following page

(2) Tightening torque

No.	Part name	Bolt size	Dimension (B)	Torque	
				kgf·m	lbf·ft
33	Relief valve	M33	36	24	173.59
42	Plug	PF1/4	6	4	28.93
31	Wrench bolt	M14	12	44	318.25
31	Wrench bolt	M30	14	24	173.59
36	Reverse preventing valve	M22	10	22	159.1
47	Wrench bolt	M6	5	1	7.23

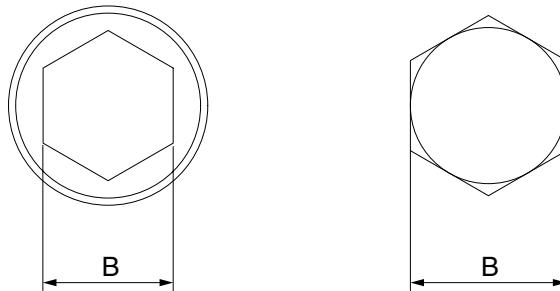

300H8SM04

(3) Brake piston removal tool

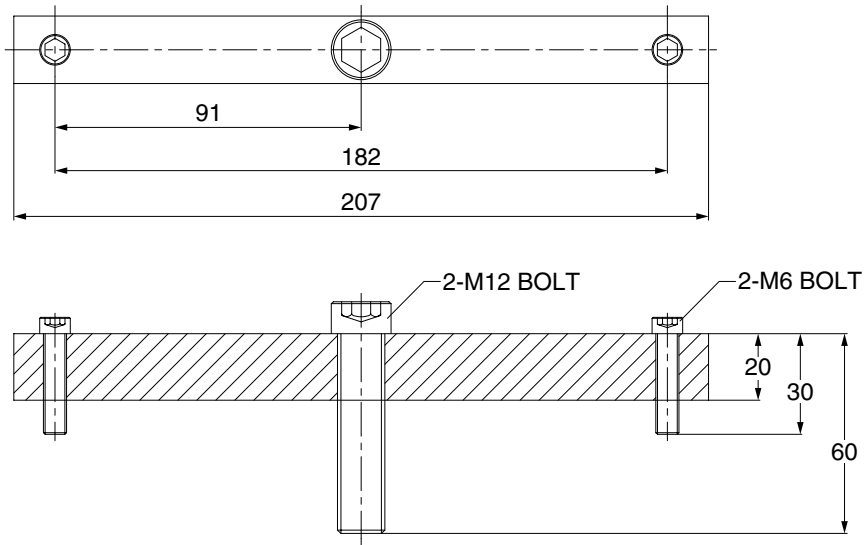

300H8SM03

2) DISASSEMBLY

- (1) Set up the motor assy on the workbench for disassembly

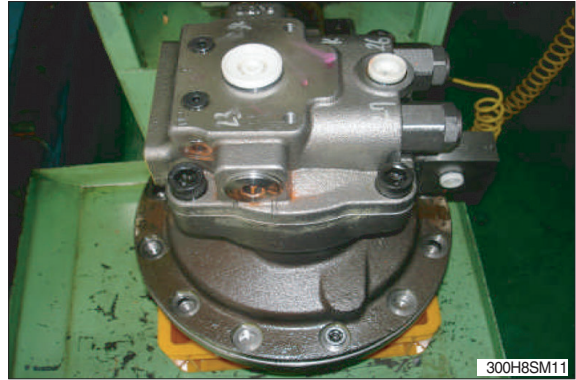

- (2) Draw the line to body (1) and rear cover (25).

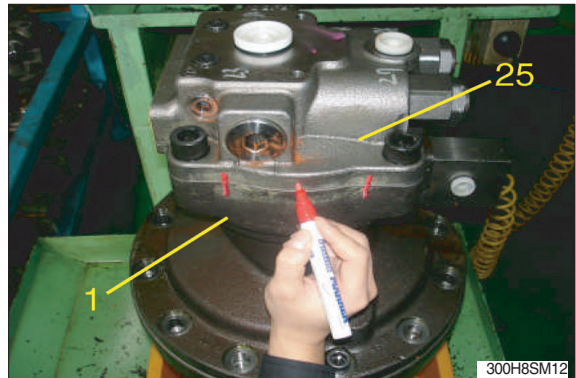

- (3) Use the L-wrench to disassemble the time delay valve (46) from the body (1).

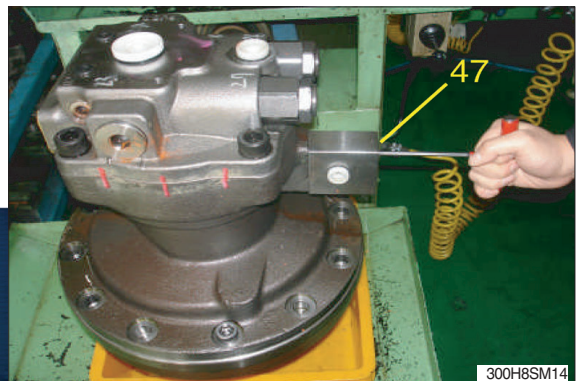
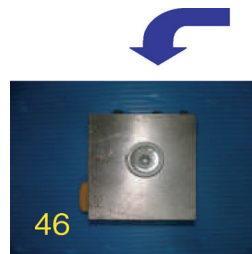

- (4) Disassemble the relief valve (41) from the rear cover (25).

- ※ Do not disassemble the relief valve (41) never.
This will change the pressure setting of the valve.

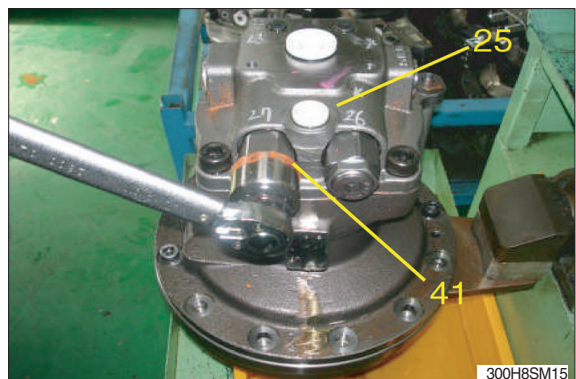

- (5) Disassemble the make up valve plug (32) from the rear cover (25).

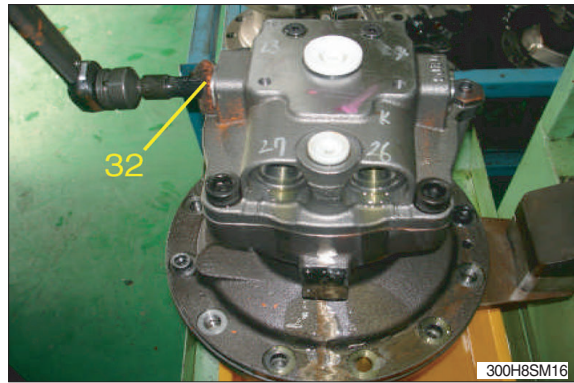

- (6) Disassemble plug (32), spring (35), check (34) from rear cover (25).



- (7) Disassemble reverse prevention valve assy from the rear cover (25).



- (8) Disassemble the four bolts.
Rear cover (25) is some disassembled from body (1) because of spring force

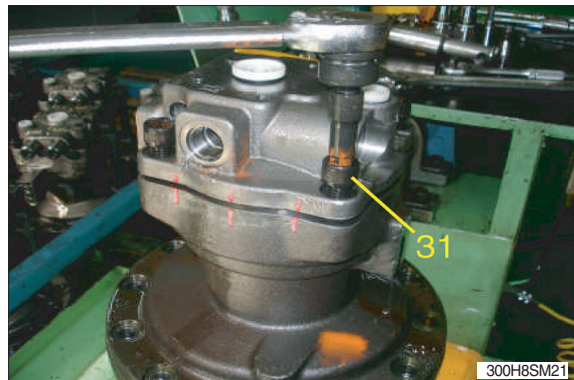

(9) Disassemble the rear cover (25) from the body (1).

※ Loosen the pipe screw before disassemble the rear cover (25).

The valve plate (30) may be disassembled with the rear cover (25).

Be careful lest the valve plate (30) remove from the rear cover (25).

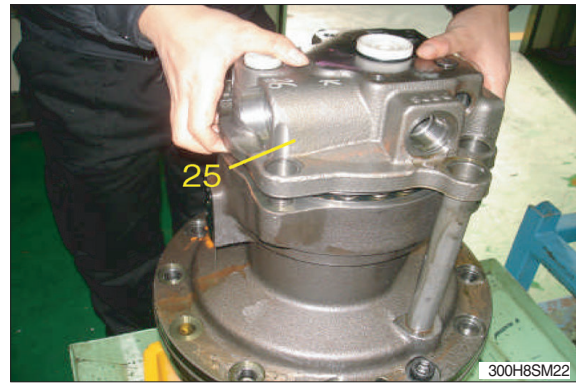

(10) Disassemble all spring (24) from the brake piston (23).

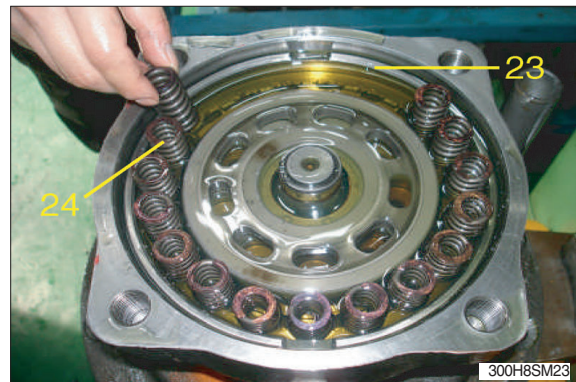

(11) Use the brake piston removal tool to disassemble the brake piston (23).

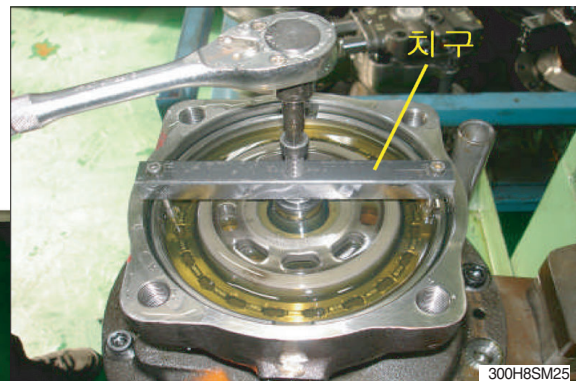
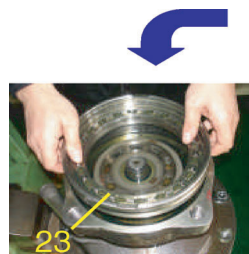

(12) The workbench horizontally, disassemble cylinder block assy (11) , friction plate (20) 2ea, plate (19) 3ea, from the shaft (2) safely.

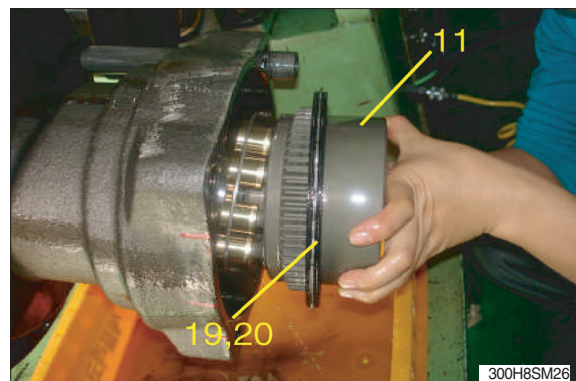

(13) Disassemble the shoe plate (10) from the body (1).



(14) Rotate the workbench through 180 degrees and disassemble the snap ring (9) from body (1).



(15) After turn workbench vertically, hit the shaft (2) using the hammer and disassemble from the body (1). At this time, the shaft which became the shrink fit and cover (6) are disassembled together.



(16) Disassemble the snap ring (3) and oil sear (7) from the shaft (2). Use the pliers to disassemble the snap ring (3)



(17) After put on the shaft to jig, use the press to disassemble the bearing.
Do not reuse the bearing (5)



(18) Use the seal removal tool or press to disassemble the oil seal (7) from the cover (6).
Do not reuse the oil seal (7)

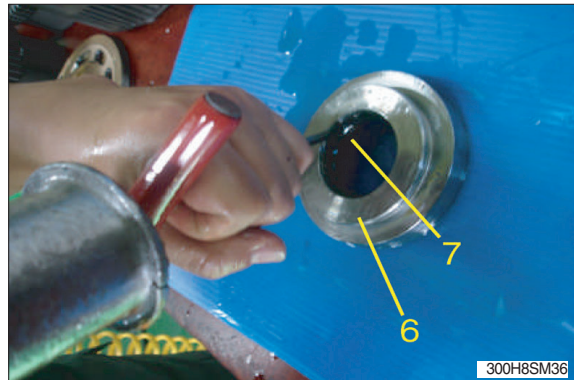

(19) Disassemble the valve plate (30) from the rear cover (25).

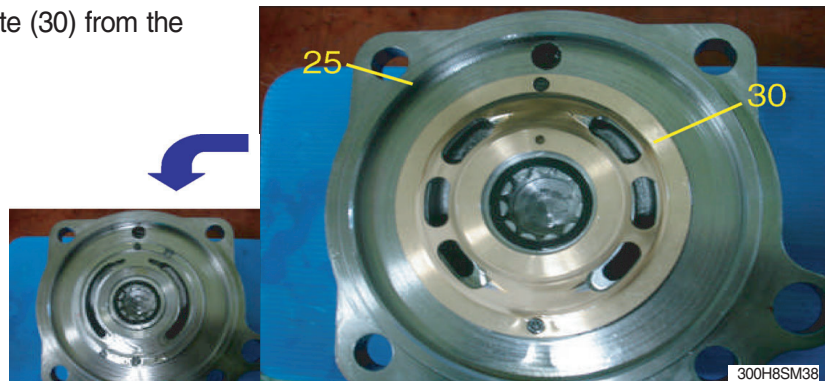

(20) Disassemble the O-ring (26) from rear cover (25) and body (1).

※ Damage of the O-ring and do not reuse if possible.

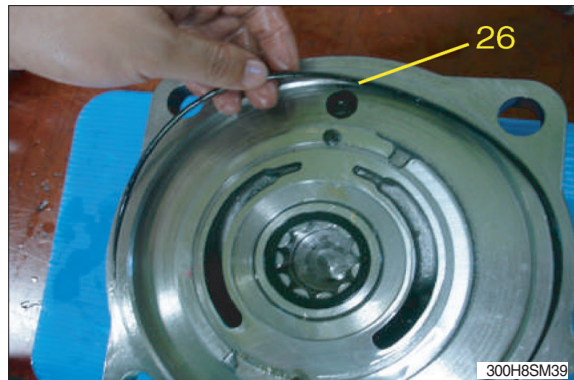

(21) Disassemble the roll bearing (27) from the rear cover (25) using the bearing puller.

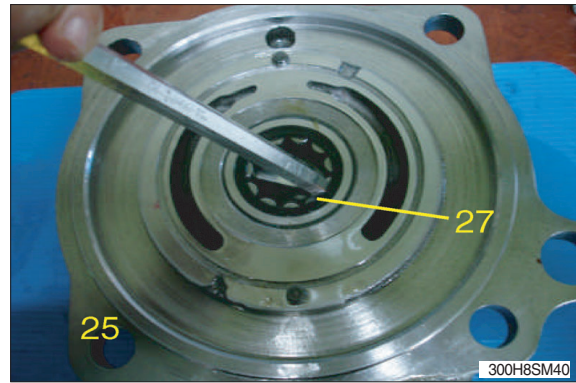

(22) Use the L-wrench to disassemble the plug (42) from the rear cover (25).

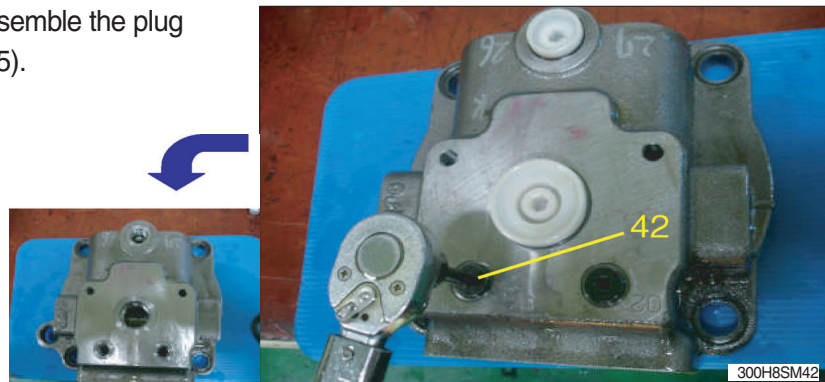

Disassembly has completed.

4) ASSEMBLY

(1) General precautions

- ① After washing each parts cleanly, dry it with compressed air.
- ② In bonding each part, fasten bond torque.
- ③ When using a hammer, do not forget to use a plastic hammer.

(2) Assembling swing motor

- ① Set up the body (1) on the workbench.

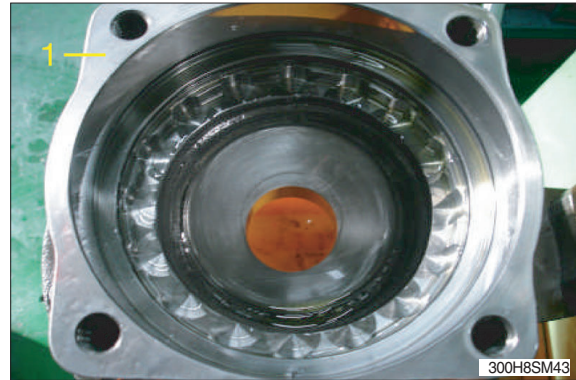

- ② Use the jig to assemble the oil seal (6) in the cover (7).
Be careful in direction of the oil seal.

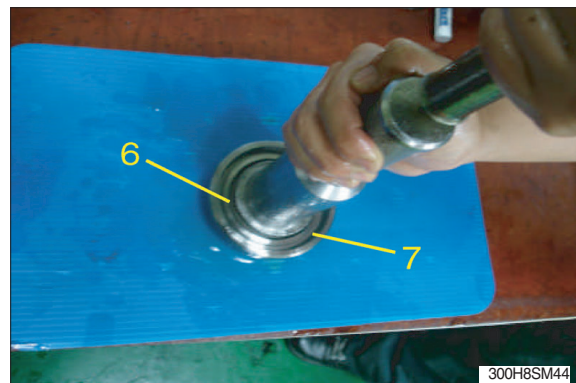

- ③ Assemble the roll bearing (5) which becomes the shrink fit in the shaft (2).

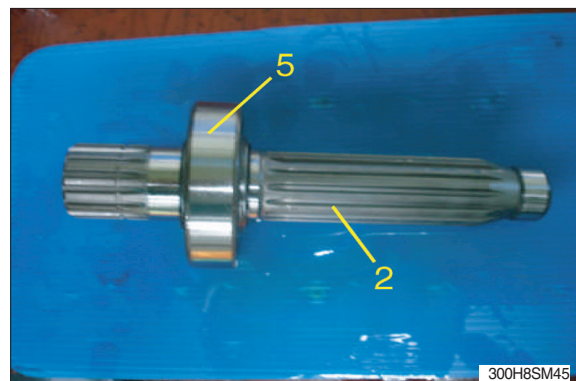

- ④ Assemble the shaft (2) lower part of the body (1).
Use the hammer and hit the end of shaft lightly until the shaft does not move.

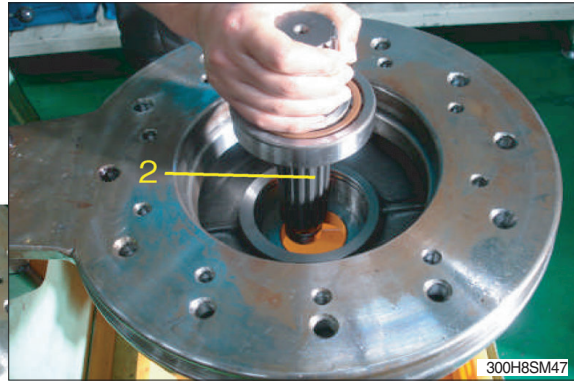

- ⑤ Assemble the cover (with the oil seal) in the shaft (2) and fix with the snap ring (9).

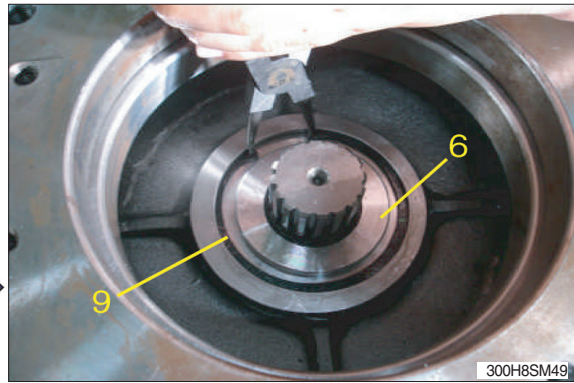

- ⑥ Assemble the shoe plate (10) in the body (1).

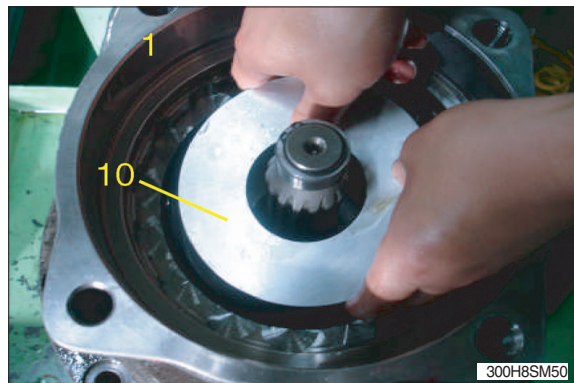

- ⑦ Like the figure, assemble the pin (15) and ball guide (12) in the cylinder block (10).

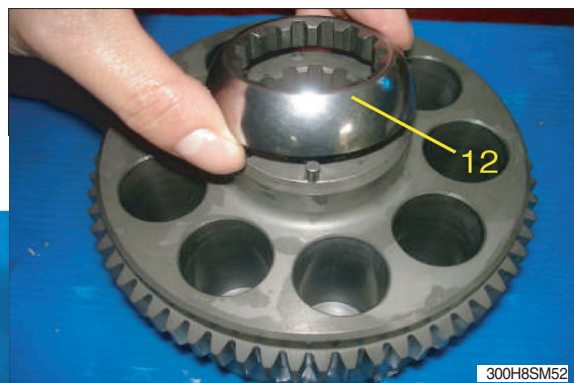

- ⑧ Assemble the piston assy (18) in the set plate (17).



- ⑨ Assemble the piston assy (18) in the cylinder block (11).
Apply the clean hydraulic oil in the piston assy and hole of cylinder block (11) before assemble the piston assy (18)

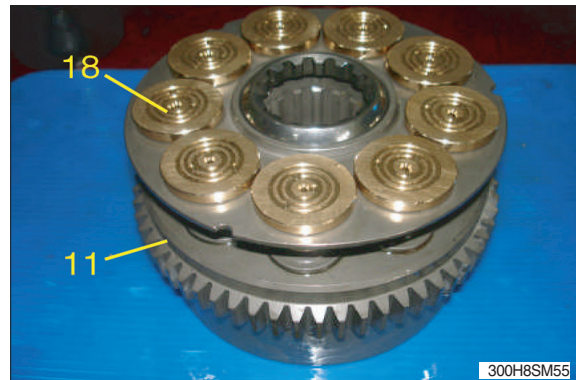

- ⑩ The workbench horizontally, assemble the cylinder block assy in the body (1) and insert the O-ring (21, 22).



- ⑪ Insert the O-ring (21, 22) in the body (1).

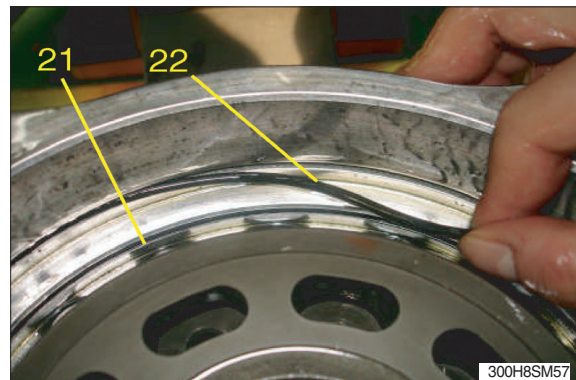

- ⑫ Like a figure, assemble two friction plate (20) and three plate (19) in the body (1).

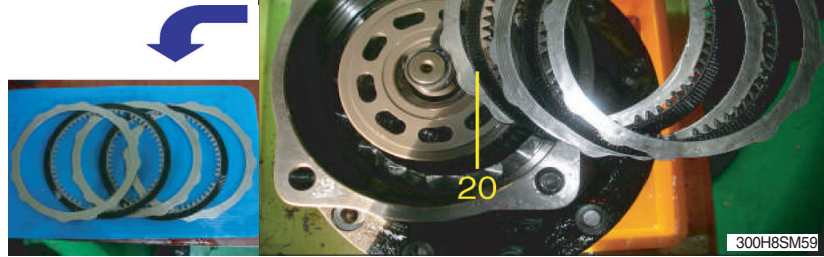

- ⑬ Assemble the brake piston (23) in the body (1).

- ※ The brake piston will not be assembled well.
In that case, after tighten M6 bolt in the hole of brake piston, hit them using the hammer.



- ⑭ Assemble twenty spring (23) in the brake piston (23).

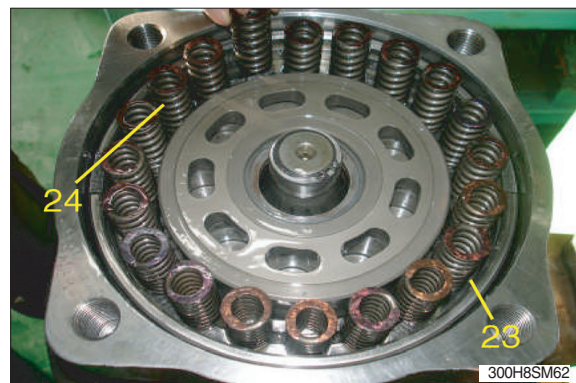

- ⑮ Use the jig to assemble the needle bearing (27) in the rear cover (25).

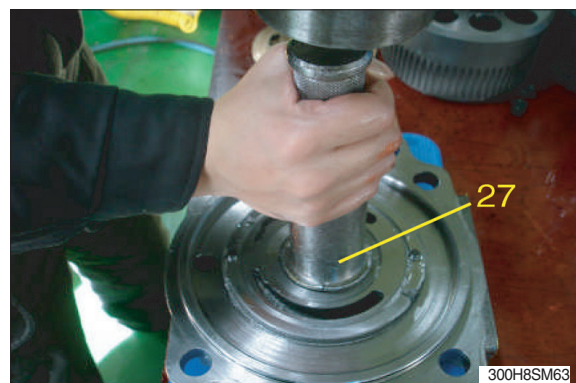

- ⑩ Use the jig to assemble the pin (29) in the rear cover (25).

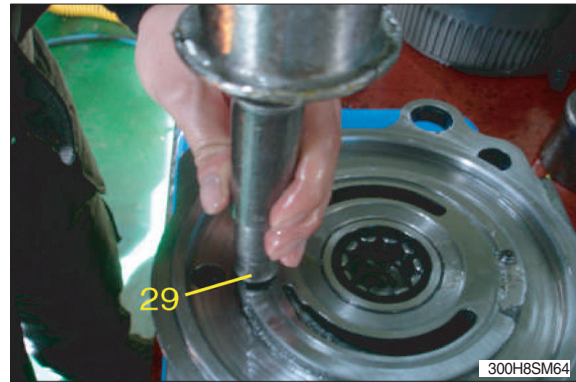

- ⑪ Insert the O-ring (26) in the rear cover (25).
Spread the lubricant in the O-ring.

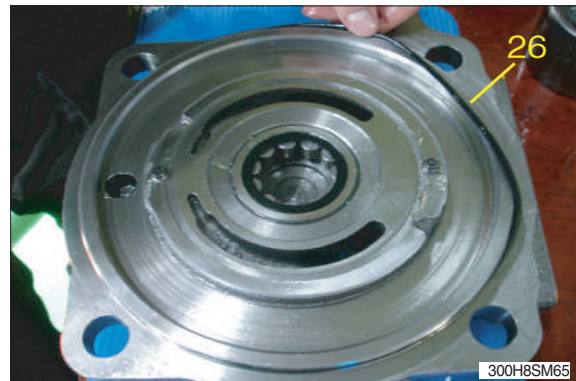

- ⑫ Assembles the valve plate (30) in the rear cover (25).

- ※ When assemble the valve plate in the rear cover, spread the lubricant a little in the fixed surface.
The notch which has orifice hole ($\varnothing 1.0$) of the valve plate is located in the other side of the flange face (A, B port)

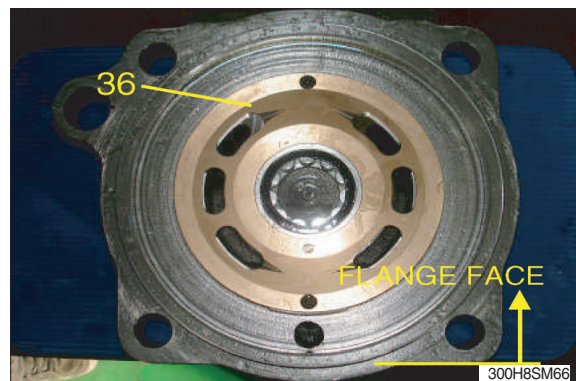

- ⑬ Assemble the rear cover (25) in the body (1).

- ※ Indicate the rear cover on fixed line.
Tight bolts with the specified torque.



- ⑳ Assemble the make up valve in the rear cover check that the poppet (34) should have been operated softly

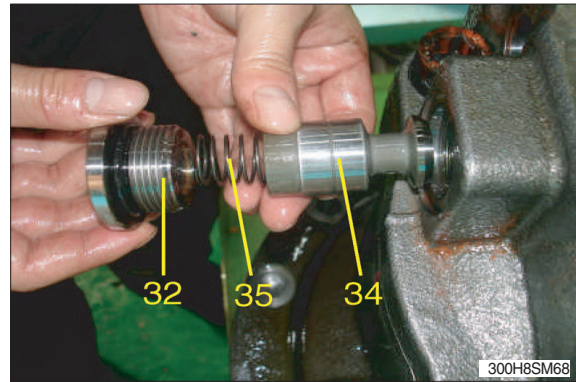

- ㉑ After assembling the reverse prevention valve assy in the rear cover (25), assembles the plug (37) which the O-ring inserted.

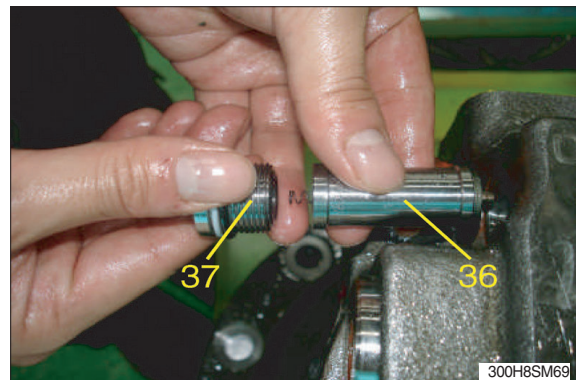

- ㉒ Use the wrench to assemble the relief valve assy (41) in the rear cover (25). Spread some lubricant in the O-ring of the relief valve assy.

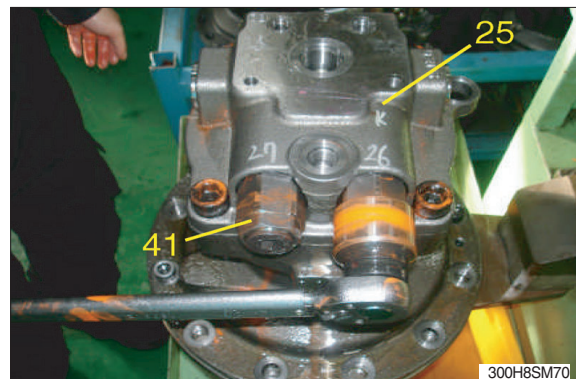

- ㉓ Assemble the plug (42) in the cover (25) using the L-wrench.

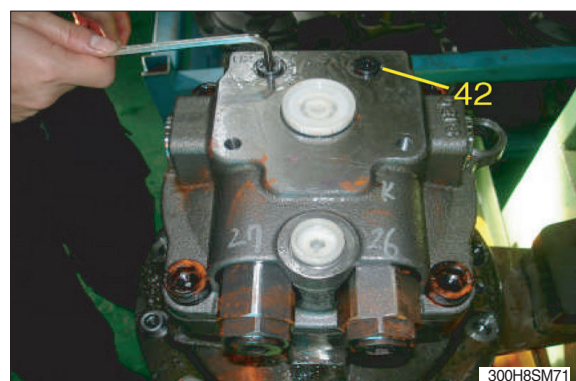

- ②④ Assemble the time delay valve assy (46) in the body (1) using the wrench bolt (47 3ea).

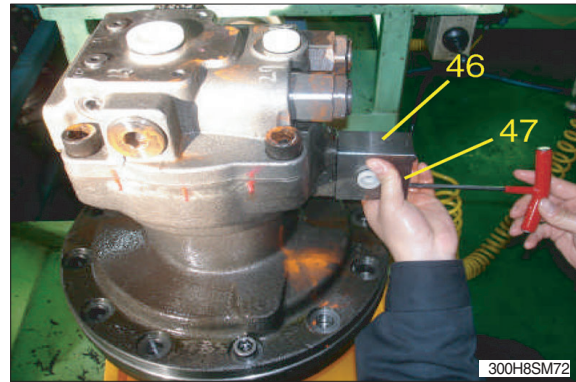

- ②⑤ After assemble the level gauge pipe (48) in the body (1) and rear cover (25), use the bolt to fix them.



Assembly has completed.

3. REMOVAL AND INSTALL OF REDUCTION GEAR

1) REMOVAL

- (1) Remove the swing motor assembly.
For details, see removal of swing motor assembly.
- (2) Sling reduction gear assembly(1) and remove mounting bolts(2).
- (3) Remove the reduction gear assembly.
 - Reduction gear device weight : 230 kg (507 lb)



2) INSTALL

- (1) Carry out installation in the reverse order to removal.

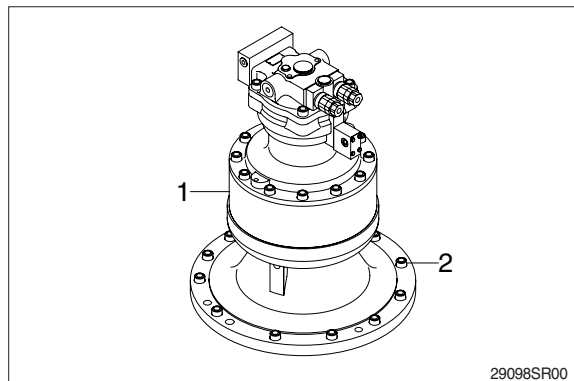

4. REDUCTION GEAR

1) STRUCTURE

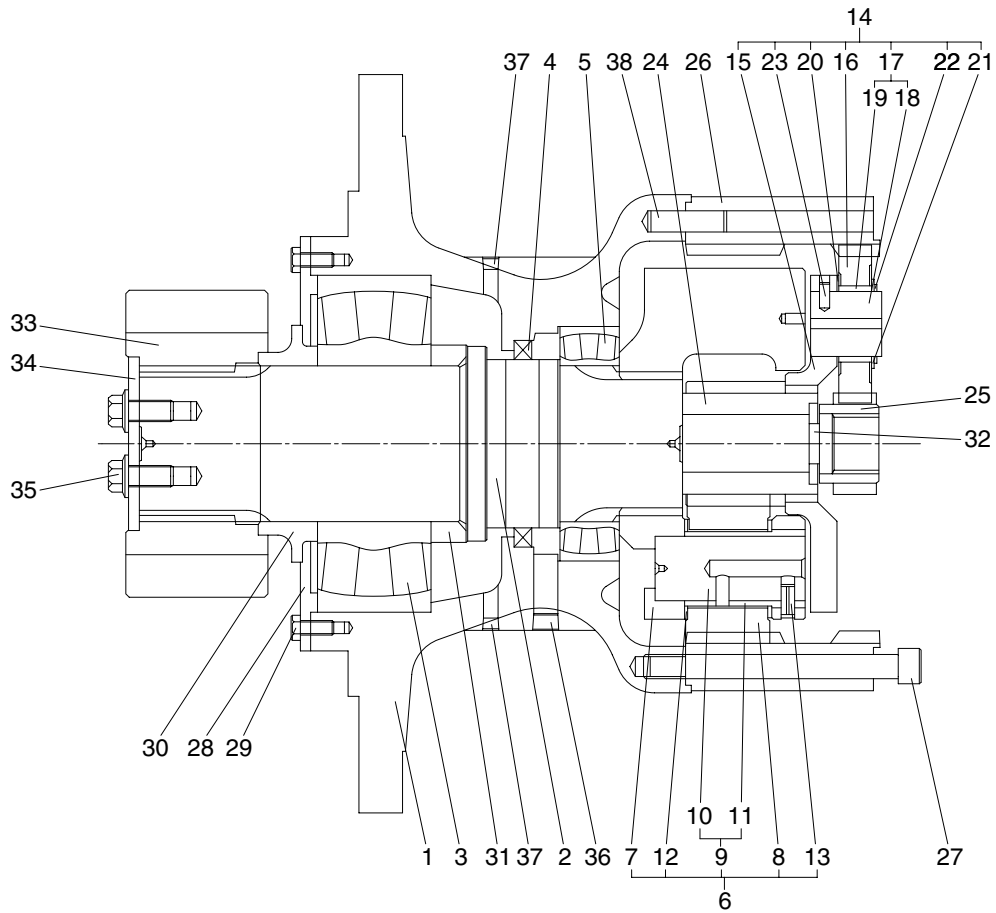

3009SH2SM02

1	Casing	14	Carrier assy 1	27	Socket bolt
2	Drive shaft	15	Carrier 1	28	Cover plate
3	Roller bearing	16	Planet gear 1	29	Hexagon bolt
4	Oil seal	17	Pin assy 1	30	Spacer
5	Roller bearing	18	Pin 1	31	Spacer ring
6	Carrier assy 2	19	Bushing 1	32	Thrust plate 3
7	Carrier 2	20	Side plate 1	33	Pinion gear
8	Planet gear 2	21	Side plate 2	34	Lock plate
9	Pin assy 2	22	Stop ring	35	Hexagon bolt
10	Pin 2	23	Spring pin	36	Plug
11	Bushing 2	24	Sun gear 2	37	Plug
12	Thrust washer	25	Sun gear 1	38	Knock pin
13	Spring pin	26	Ring gear		

2) DISASSEMBLY

- (1) Removal of swing motor
Loosen the hexagonal socket bolt (27)
and remove swing motor.

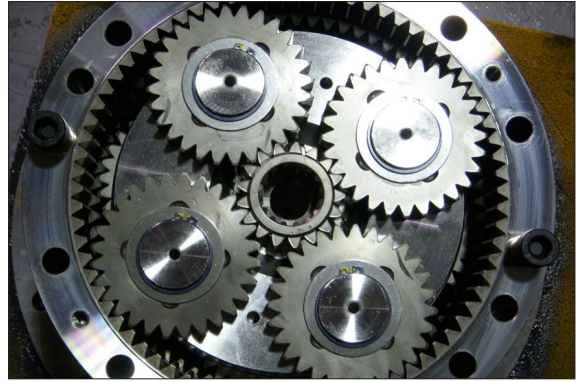

29098SR02

- (2) Removal of No.1 sun gear (25), No.3
thrust plate (32).
Install eye-bolt M10 to thread hole of No.1
carrier and remove No.1 carrier assembly
(14) itself.

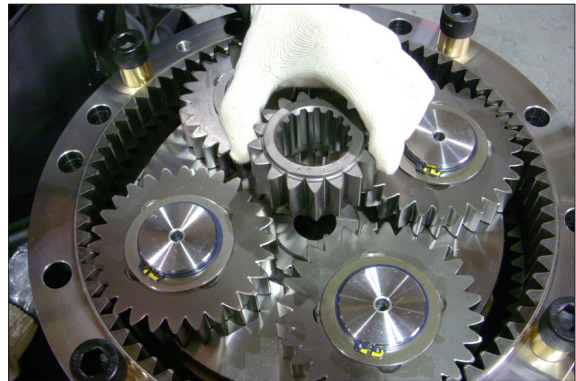

29098SR31

- (3) Removal of No.2 sun gear (24)
Install eye-bolt M10 to thread hole of No.2
carrier and remove No.2 carrier assembly
(6) itself.

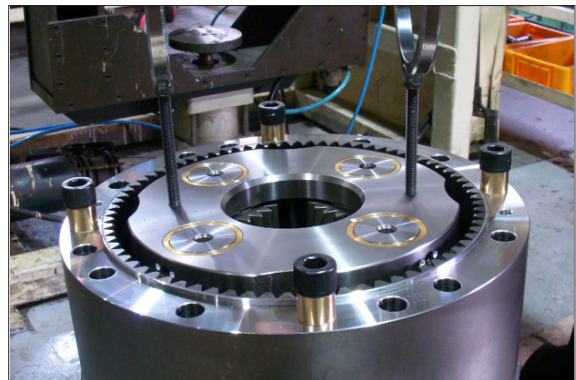

29098SR03A

- (4) Disassembly of No.2 carrier assembly (6)
- ① Place the proper tool on spring pin (13),
and then insert spring pin (13) until the
center of No.2 pin (10) with hammer.
- ※ Do not reuse spring pin (13) after
removal.



29098SR04

- ② Remove No.2 pin assy (9) and then pull out No.2 planet gear (8) and thrust washer (12) with hands.



29098SR05

- (5) Removal of ring gear(26)
Remove ring gear (26) from casing (1).
※ Liquid gasket is applied on contacting surface of ring gear (26) and casing (1) to prevent gear oil from leaking.
Therefore, remove ring gear (26) from casing (1) by minus screw driver through grooves of casing (1).

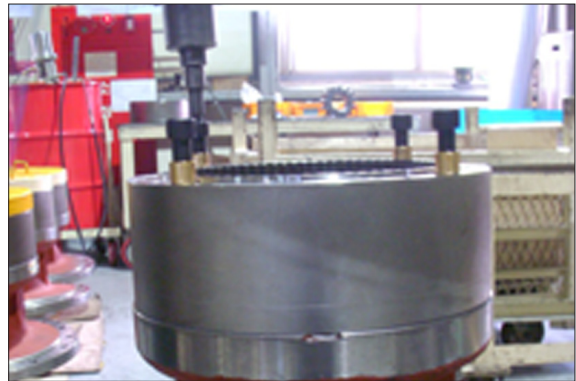

29098SR06

- (6) Removal of pinion gear (33)
Remove hexagon head bolt (35), lock plate(34), pinion gear (33), spacer(30) and cover plate (28) when pinion gear (33) is not disassembled from drive shaft (2) easily. Use rubber hammer to the pinion gear (33)



29098SR07



29098SR08

(7) Removal of drive shaft (2)

- ① Install a support under flange surface area of casing (1).

Install hydraulic press to the end surface of drive shaft (2) and remove the drive shaft (2) with roller bearing (3) and spacer ring (31).

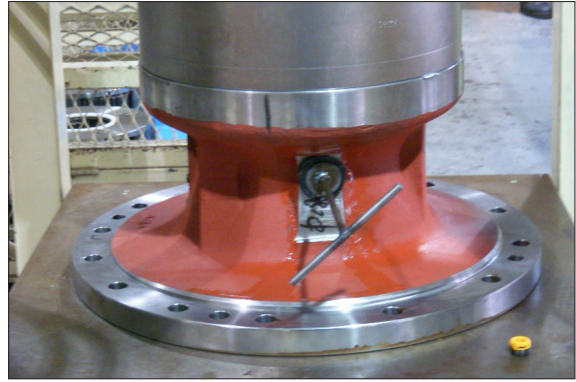

29098SR09

- ② Remove roller bearing (3) and spacer ring (31) from drive shaft (2).



29098SR10

- ③ Remove roller bearing (5), oil seal (4) from casing (1)

※ Do not reuse oil seal (4).

※ Drive shaft assembly is only disassembled when roller bearing is needed to be replaced due to wear, oil leaking.



29098SR11

3) ASSEMBLY

(1) Assembly of drive shaft (2) and parts

① After assemble spacer ring (31) to drive shaft (2) hydraulic press fit roller bearing (3) to drive shaft (2).

② Heat roller bearing up to 80~90°C plus surrounding temperature and remove magnetism for 5 minutes.

Assemble it to drive shaft (2) with hydraulic press and then assemble spacer ring (31) in this order.

※ Pay attention to the assembling direction of spacer ring (31).

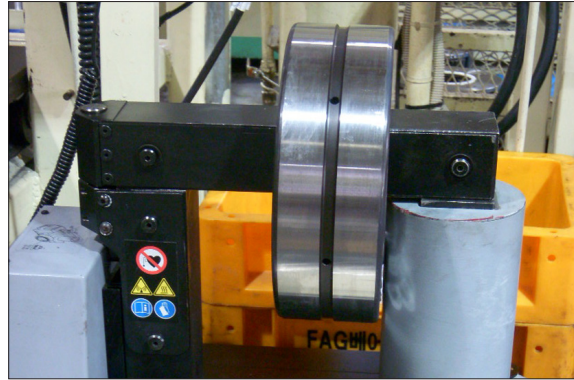

29098SR12



29098SR13

(2) Installation of oil seal(4)

Remove oil from oil seal (4) and the surface area of casing (1) to which oil seal (4) is to be assembled.

Assemble oil seal to the casing (1) with press fitting jig and then apply grease to the rib of oil seal (4).



29098SR14



29098SR15

(3) Assembly of drive shaft (2) and parts

- ① Place the output parts of casing (1) upward.

Install eye-bolt M16 into the thread hole of the output end surface of drive shaft assembly.

- ② Lift drive shaft assembly using the eye-bolts and then assemble that to casing (1).



29098SR16

(4) Install of roller bearing (5)

Place the output part of casing assembly down ward.

Heat roller bearing (5) up to 80~90°C plus surrounding temperature and remove magnetism for 5 minutes assemble it the drive shaft (2).



29098SR17

(5) Assembly of pinion gear (33)

- ① Assemble cover plate (28), hexagon bolt (35) to casing (1).

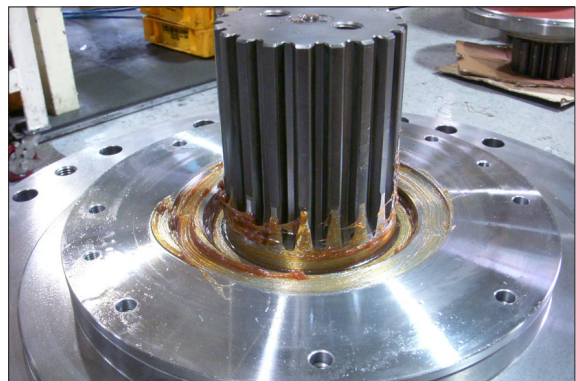

29098SR18

- ② After assemble spacer (30), pinion gear (33) and lock plate (34) tighten hexagon bolt (35).



29098SR19

(6) Assembly of ring gear (26)

- ① Remove oil from mating surfaces between casing (1) and ring gear (26) and from knock pin (38). Liquid gasket (three bond No. 1194 equivalent) around socket bolt (27) hole at casing.



29098SR22

- ② Assemble ring gear (26) to casing assembly correctly using lock pin hole as guide.



29098SR23

(7) Assembly of No.2 carrier assembly (6)

- ① Assemble No.2 planet gear (8) to No.2 carrier (7) with thrust washer (12) and insert No.2 pin (10) correctly and No.2 pin (10) is around with spring pin hole at No.2 carrier (7).

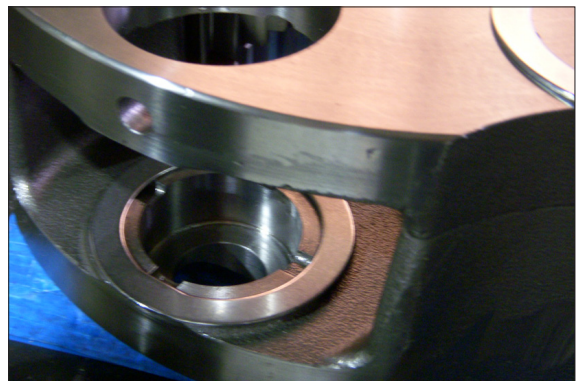

29098SR24

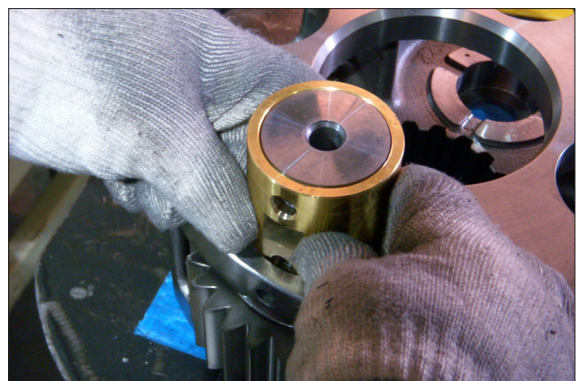

29098SR25

- ② Insert spring pin (13) into No.2 carrier (7) hole and No.2 pin (10) hole.



29098SR26

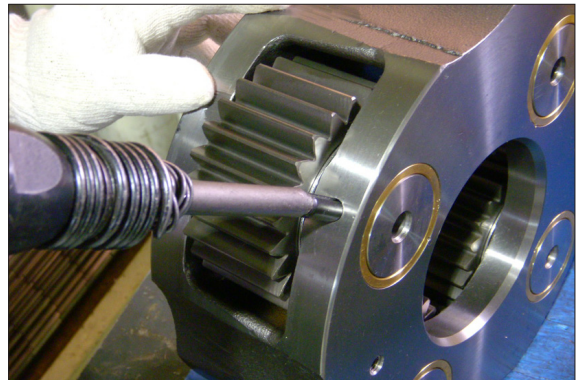

29098SR27

(8) Assembly of No.2 carrier assembly (6)

- ① Install eye bolt into thread hole M10 of No.2 carrier (7) and lift No.2 carrier assembly (6) using the eye-bolt. And then insert No.2 carrier assembly (6) being engaged with internal teeth of ring gear (26). Rotate carrier assembly lightly so that splines of drive shaft (2) are engaged.

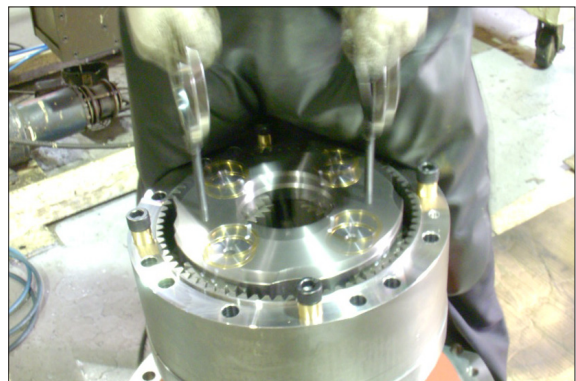

29098SR28

- ② Insert No.2 sun gear (25) into No.2 planet gear (8).



29098SR29

(9) Assembly of No.1 carrier assembly (14)

① Mount eye bolt into thread hole M10 of No.1 carrier assembly (14) and lift the assembly using the eye-bolt and then insert No.1 carrier assembly (14) being engaged with internal teeth of ring gear (26).

② Rotate No.1 carrier assembly (14) lightly so that No.2 sun gear (24) is engaged with teeth No.1 carrier assembly (14).



29098SR30

③ Insert No.1 sun gear (25) into No.1 planet gear (16).

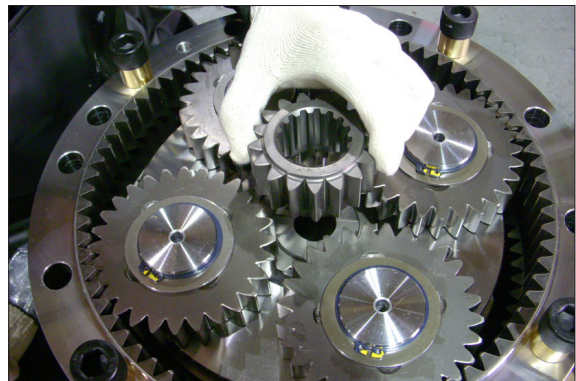

29098SR31

(10) Check smoothness of gear rotation by turning No.1 carrier assy (14).

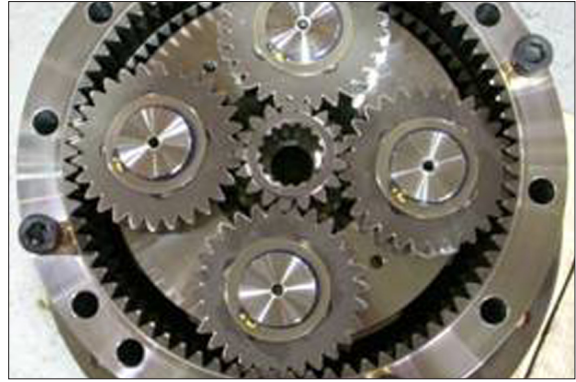

29098SR32

(11) Assembly of swing motor

- ① Remove oil from mating surfaces between ring gear (26) and swing motor and apply liquid gasket (three bond No.1194 equivalent) around socket bolt hole at ring gear.

Assemble swing motor and tighten socket bolt (27) with 18mm hexagonal socket.

- Tightening torque : 34 kgf·m (246 lbf·ft)