

GROUP 4 POWER BOOST SYSTEM

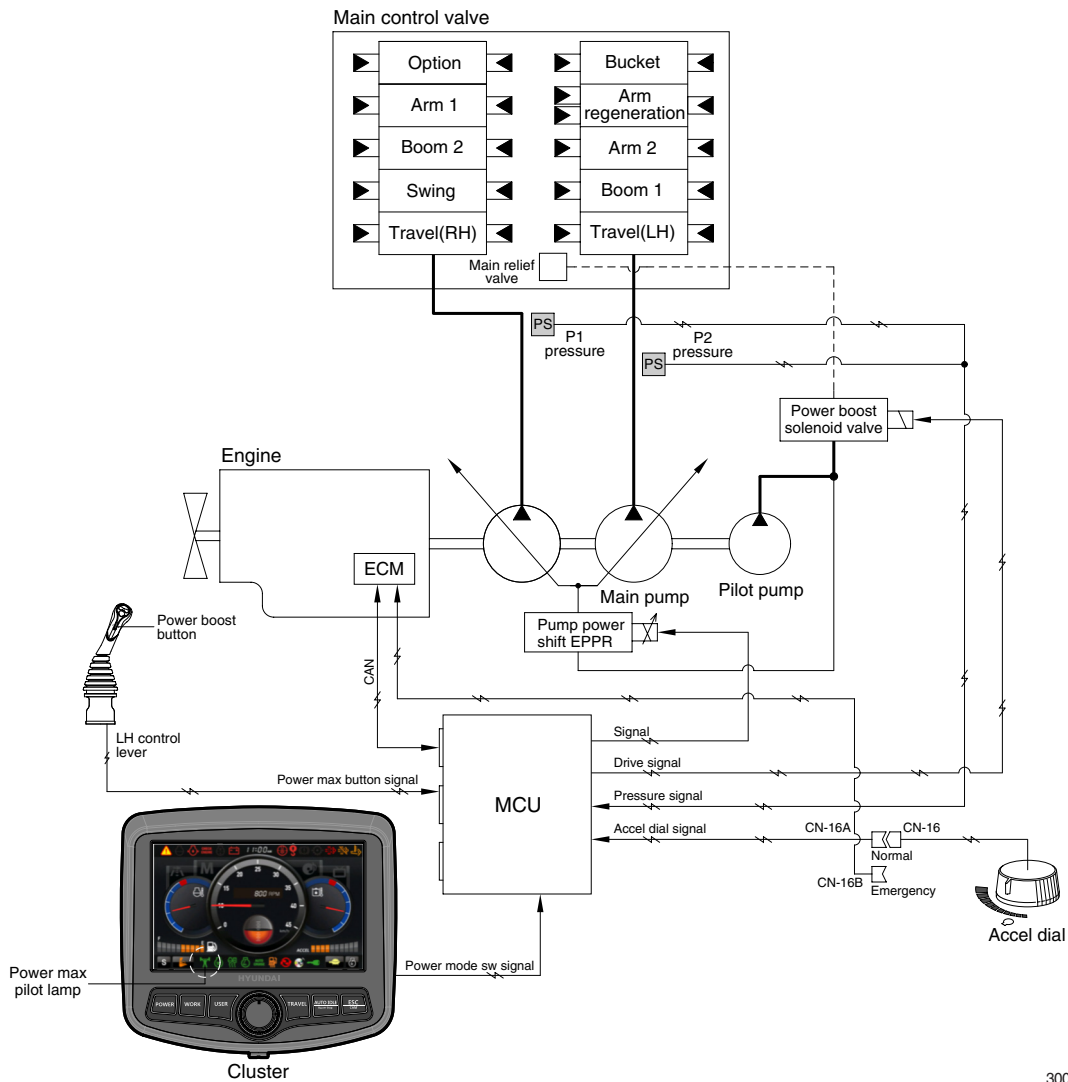

3009A5MS06

- When the power boost switch on the left control lever knob is pushed ON, the power mode is set P mode and maximum digging power is increased by 10 %.
- When the power boost function is activated, the power boost solenoid valve pilot pressure raises the set pressure of the main relief valve to increase the digging power.

Description	Condition	Function
Activated	Power boost switch : ON Accel dial : over 8	- Power mode : P - Accel dial power : 9 - Power boost solenoid : ON - Power boost pilot lamp : ON - Operating time : max 8 seconds
Canceled	Power boost switch : OFF	- Pre-set power mode - Power boost solenoid : OFF - Power boost pilot lamp : OFF

- ※ When the auto power boost is set to Enable and power mode is set to P mode on the cluster, the digging power is automatically increased as working conditions by the MCU. It is operated max 8 seconds.