

GROUP 7 WORK EQUIPMENT

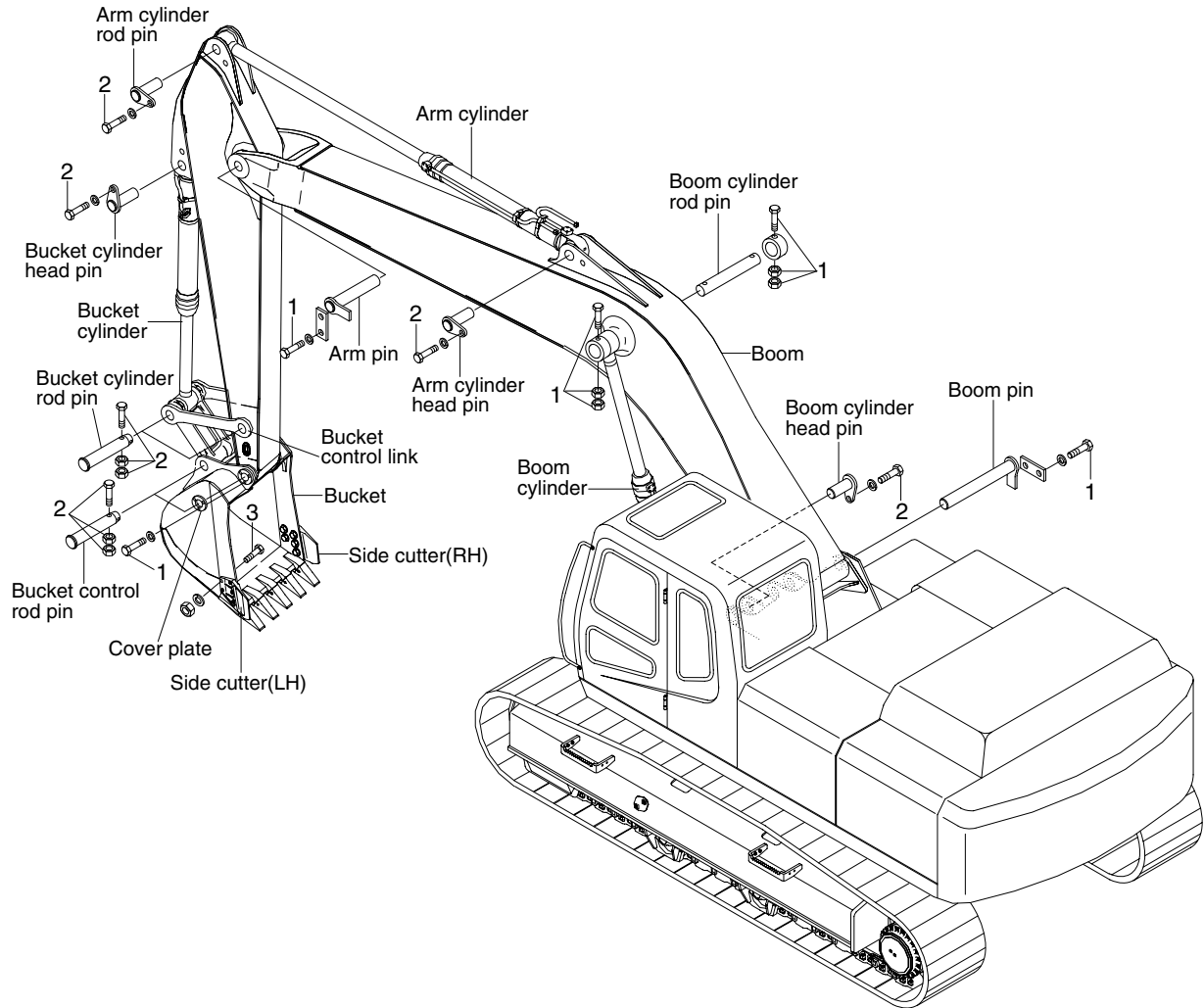

30079CM13

· Tightening torque

Item	Size	kgf · m	lbf · ft
1	M16×2.0	29.7±4.5	215±32.5
2	M20×2.5	57.9±8.7	419±62.9

Item	Size	kgf · m	lbf · ft
3	M22×2.5	81.9±16.1	592±116
-	-	-	-