

GROUP 6 STRUCTURE

CAB AND ACCESSORIES MOUNTING

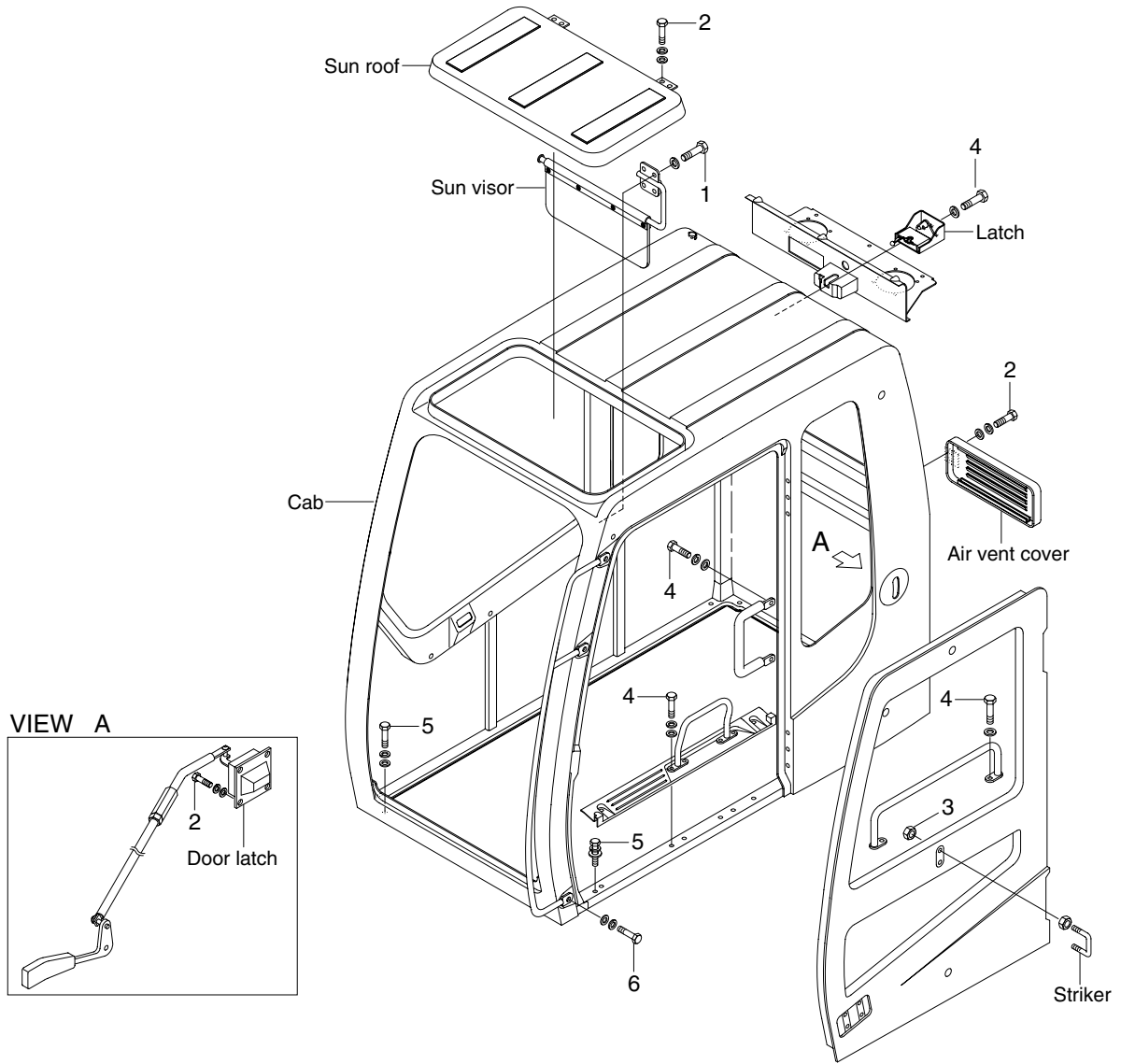

29079CM09

· Tightening torque

Item	Size	kgf · m	lbf · ft
1	M 6×1.0	0.49±0.1	3.5±0.7
2	M 8×1.25	2.5±0.5	18.1±3.6
3	M10×1.5	4.7±0.9	34±6.5

Item	Size	kgf · m	lbf · ft
4	M10×1.5	6.9±1.4	49.9±10.1
5	M12×1.75	12.8±3.0	92.6±21.7
6	M16×2.0	29.7±4.5	215±32.5

CAB INTERIOR MOUNTING

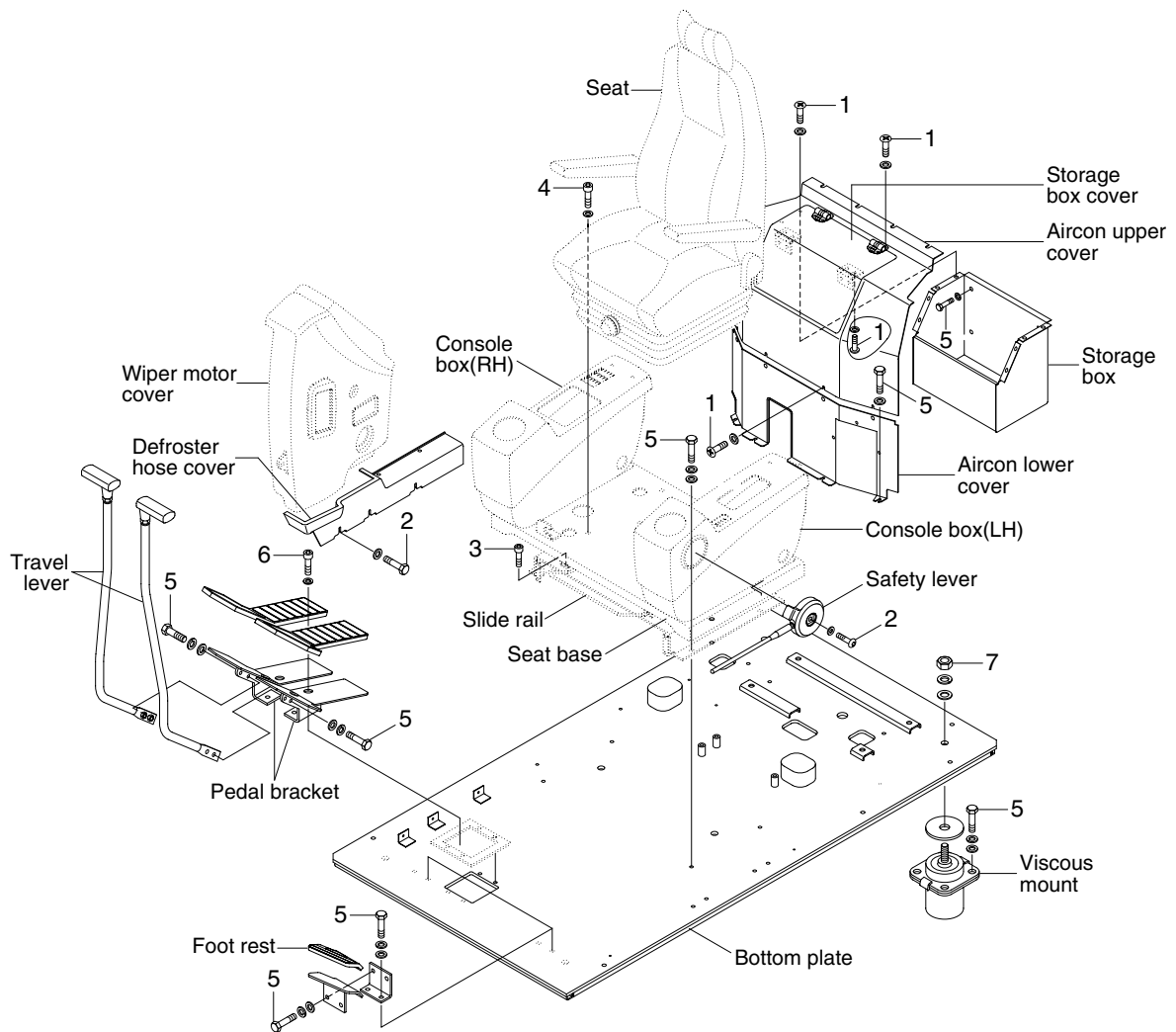

29079CM10

· Tightening torque

Item	Size	kgf · m	lbf · ft
1	M 6×1.0	0.49±0.1	3.5±0.7
2	M 6×1.0	1.05±0.2	7.6±1.4
3	M 8×1.25	3.43±0.7	24.8±5.1
4	M 8×1.25	2.5±0.5	18.1±3.6

Item	Size	kgf · m	lbf · ft
5	M10×1.5	6.9±1.4	49.9±10.1
6	M10×1.5	8.27±1.7	59.8±12.3
7	M16×2.0	29.7±4.5	215±32.5
-	-	-	-

COWLING MOUNTING

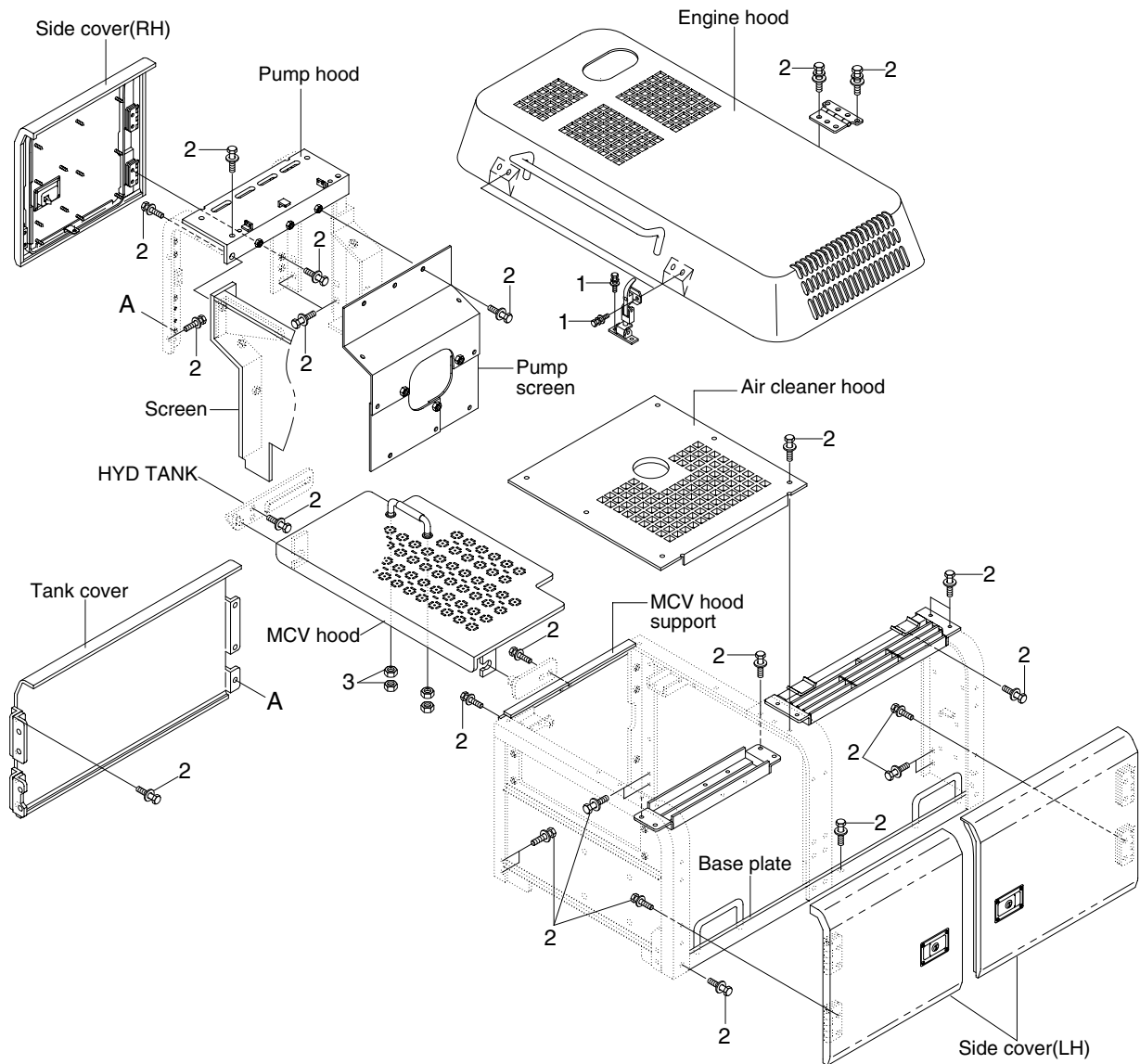

30079CM11

· Tightening torque

Item	Size	kgf · m	lbf · ft
1	M 8×1.25	2.5±0.5	18.1±3.6
2	M12×1.75	12.8±3.0	92.6±21.7

Item	Size	kgf · m	lbf · ft
3	M16×2.0	29.7±4.5	215±32.5
-	-	-	-

COUNTERWEIGHT AND COVERS MOUNTING

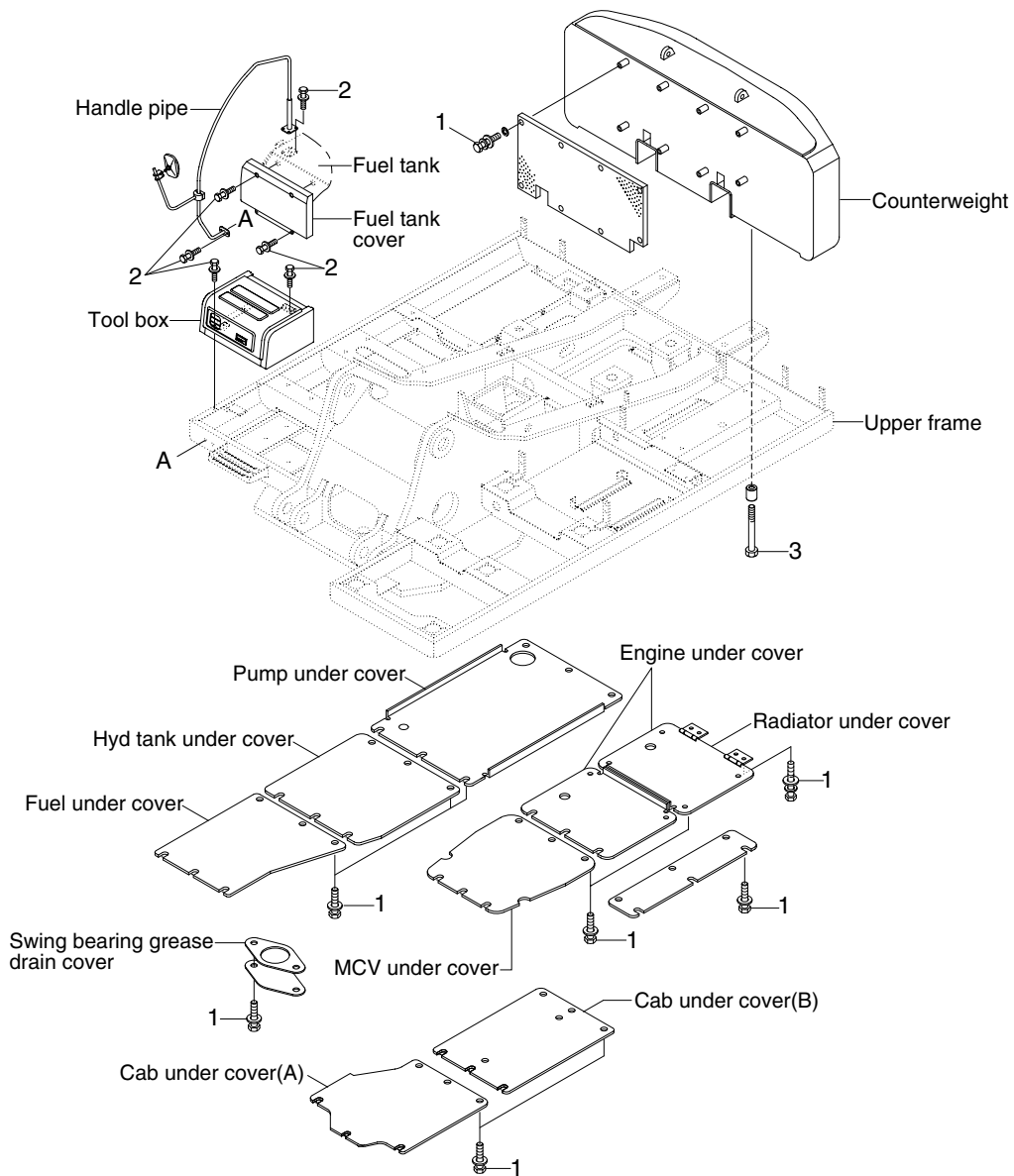

30079CM12

· Tightening torque

Item	Size	kgf · m	lbf · ft
1	M10×1.5	6.9±1.4	49.9±10.1
2	M12×1.75	12.8±3.0	92.6±21.7

Item	Size	kgf · m	lbf · ft
3	M36×3.0	308±46	2228±333
-	-	-	-