

# GROUP 2 SPECIFICATIONS

## 1. MAJOR COMPONENT

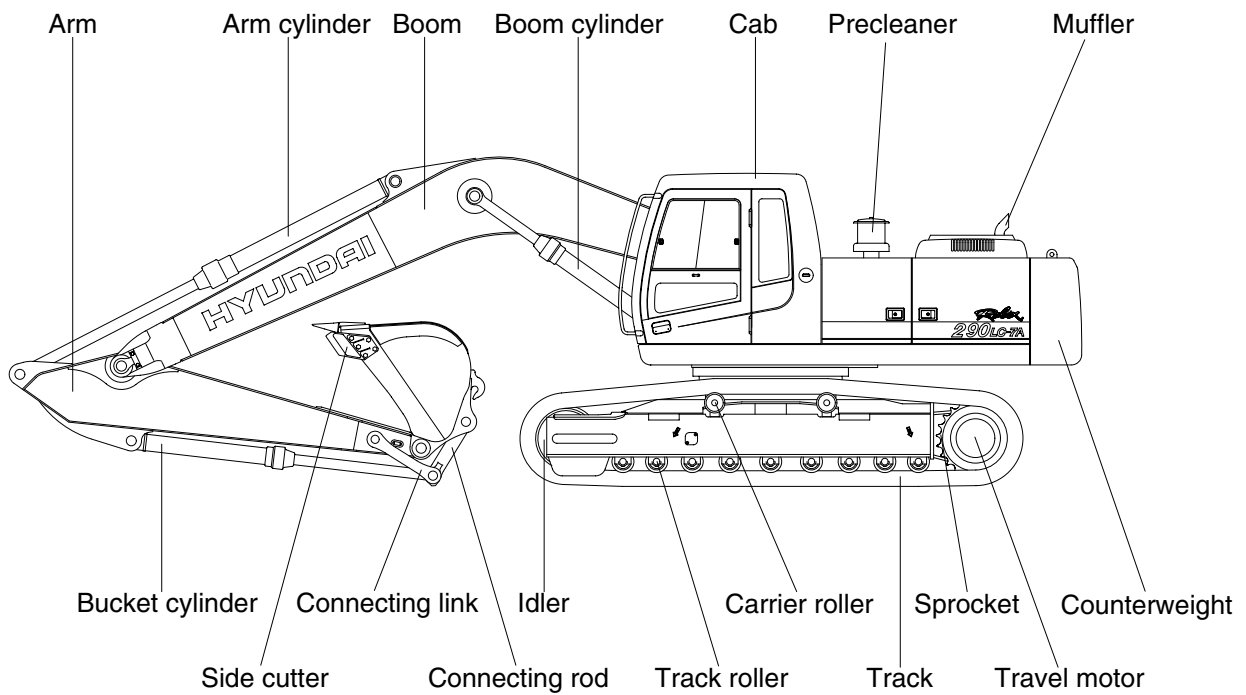
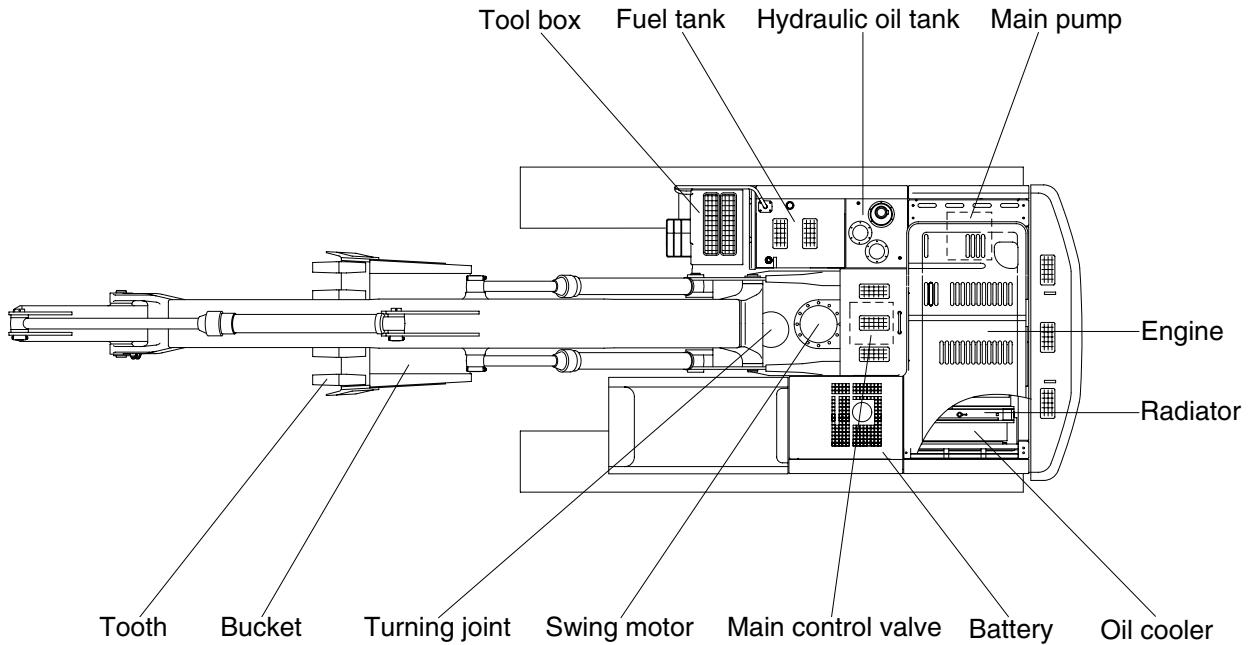

2907A2SP00

## 2. SPECIFICATIONS

### 1) R290LC-7A

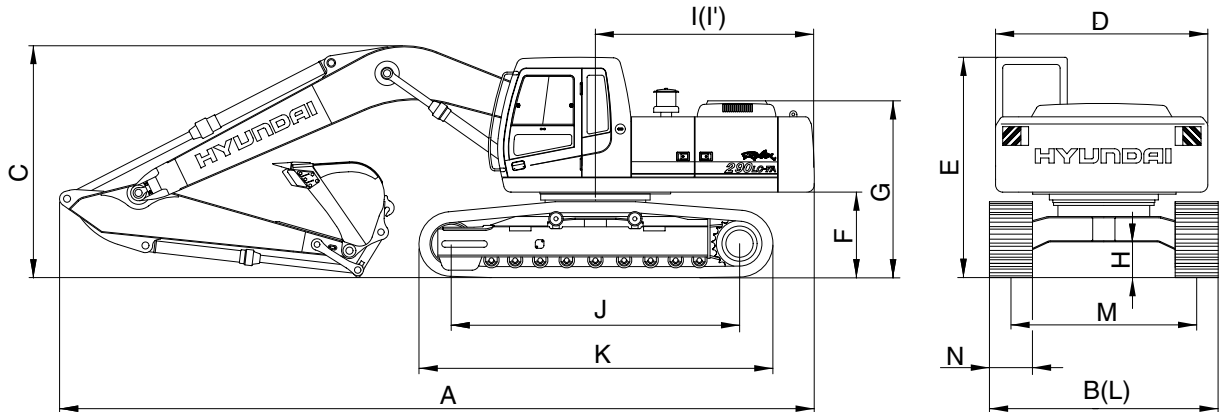

2907A2SP01

Description		Unit	Specification
Operating weight		kg(lb)	29300(64600)
Bucket capacity(SAE heaped), standard		m <sup>3</sup> (yd <sup>3</sup> )	1.27(1.66)
Overall length	A	mm(ft-in)	10560(34' 8")
Overall width, with 600mm shoe	B		3200(10' 6")
Overall height	C		3290(10' 10")
Superstructure width	D		2980( 9' 9")
Overall height of cab	E		3010( 9' 11")
Ground clearance of counterweight	F		1190( 3' 11")
Engine cover height	G		3190(10' 6")
Minimum ground clearance	H		500( 1' 8")
Rear-end distance	I		3200(10' 6")
Rear-end swing radius	I'		3120(10' 3")
Distance between tumbler	J		4030(13' 3")
Undercarriage length	K		4940(16' 2")
Undercarriage width	L		3200(10' 6")
Track gauge	M		2600( 8' 6")
Track shoe width, standard	N		600(24")
Travel speed(Low/high)			km/hr(mph)
Swing speed		rpm	10.2
Gradeability		Degree(%)	35(70)
Ground pressure(600mm shoe)		kgf/cm <sup>2</sup> (psi)	0.56(7.97)

## 2) R290NLC-7A

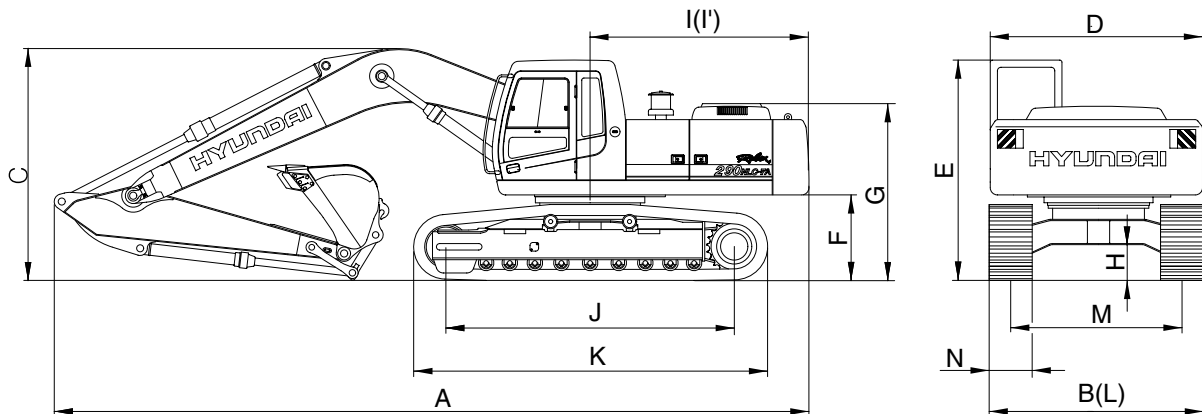

2907A2SP02

Description		Unit	Specification
Operating weight		kg(lb)	29100(64150)
Bucket capacity(SAE heaped), standard		m <sup>3</sup> (yd <sup>3</sup> )	1.27(1.66)
Overall length	A	mm(ft-in)	10560(34' 8")
Overall width, with 600mm shoe	B		2990( 9' 10")
Overall height	C		3290(10' 10")
Superstructure width	D		2980( 9' 9")
Overall height of cab	E		3010( 9' 11")
Ground clearance of counterweight	F		1190( 3' 11")
Engine cover height	G		3190(10' 6")
Minimum ground clearance	H		500( 1' 8")
Rear-end distance	I		3200(10' 6")
Rear-end swing radius	I'		3120(10' 3")
Distance between tumblers	J		4030(13' 3")
Undercarriage length	K		4940(16' 2")
Undercarriage width	L		2990( 9' 10")
Track gauge	M		2390( 7' 10")
Track shoe width, standard	N		600(24")
Travel speed(Low/high)		km/hr(mph)	3.1/5.2(1.9/3.2)
Swing speed		rpm	10.2
Gradeability		Degree(%)	35(70)
Ground pressure(600mm shoe)		kgf/cm <sup>2</sup> (psi)	0.55(7.82)

### 3) R290LC-7A LONG REACH

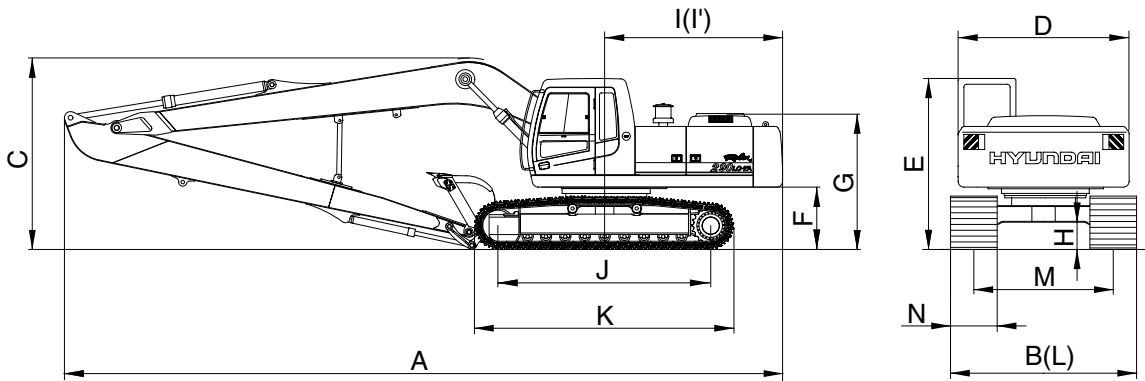

2907A2SP03

Description		Unit	Specification
Operating weight		kg(lb)	32690(72630)
Bucket capacity(SAE heaped), standard		m <sup>3</sup> (yd <sup>3</sup> )	0.52(0.68)
Overall length	A	mm(ft-in)	14550( 47' 9")
Overall width, with 800mm shoe	B		3400( 11' 2")
Overall height	C		3550( 11' 8")
Superstructure width	D		2980( 9' 9")
Overall height of cab	E		3010( 9' 11")
Ground clearance of counterweight	F		1190( 3' 11")
Engine cover height	G		3190( 10' 6")
Minimum ground clearance	H		500( 1' 8")
Rear-end distance	I		3200( 10' 6")
Rear-end swing radius	I'		3120( 10' 3")
Distance between tumblers	J		4030( 13' 3")
Undercarriage length	K		4940( 16' 2")
Undercarriage width	L		3400( 11' 2")
Track gauge	M		2600( 8' 6")
Track shoe width, standard	N		800( 31' 5")
Travel speed(Low/high)		km/hr(mph)	3.1/5.2(1.9/3.2)
Swing speed		rpm	10.2
Gradeability		Degree(%)	35(70)
Ground pressure(800mm shoe)		kgf/cm <sup>2</sup> (psi)	0.44(6.26)

#### 4) R290LC-7A HIGH WALKER

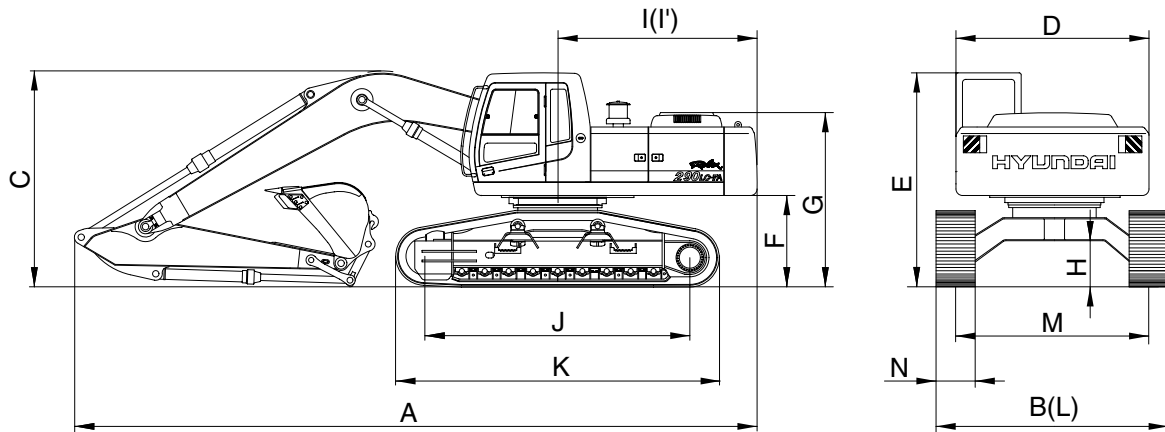

2907A2SP04

Description		Unit	Specification
Operating weight		kg(lb)	32140(70860)
Bucket capacity(SAE heaped), standard		m <sup>3</sup> (yd <sup>3</sup> )	1.27(1.66)
Overall length	A	mm(ft-in)	10430( 34' 3")
Overall width, with 600mm shoe	B		3470( 11' 5")
Overall height	C		3350( 11' 0")
Superstructure width	D		2980( 9' 9")
Overall height of cab	E		3380( 11' 1")
Ground clearance of counterweight	F		1500( 4' 11")
Engine cover height	G		3500(11' 6")
Minimum ground clearance	H		765( 2' 6")
Rear-end distance	I		3200(10' 6")
Rear-end swing radius	I'		3120(10' 3")
Distance between tumblers	J		4030(13' 3")
Undercarriage length	K		4950(16' 3")
Undercarriage width	L		3470( 11' 5")
Track gauge	M		2870( 9' 5")
Track shoe width, standard	N		600(23' 6")
Travel speed(Low/high)		km/hr(mph)	3.1/5.2(1.9/3.2)
Swing speed		rpm	10.2
Gradeability		Degree(%)	35(70)
Ground pressure(600mm shoe)		kgf/cm <sup>2</sup> (psi)	0.62(8.82)

### 3. WORKING RANGE

#### 1) R290LC-7A, R290NLC-7A [6.25m(20' 6") BOOM]

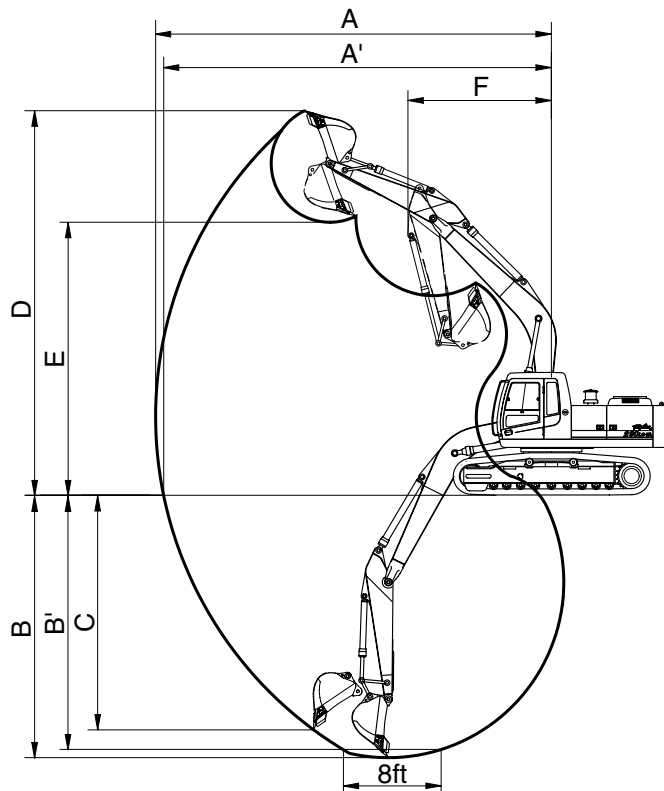

2907A2SP05

Description		2.10m(6' 11") Arm	2.50m(8' 2") Arm	3.05m(10' 0") Arm	3.75m(12' 4") Arm
Max digging reach	A	10020mm(32' 10")	10280mm(33' 7")	10820mm(35' 6")	11400mm(37' 5")
Max digging reach on ground	A'	9820mm(32' 3")	10080mm(33' 1")	10620mm(34' 10")	11220mm(36' 10")
Max digging depth	B	6440mm(21' 1")	6840mm(22' 5")	7500mm(24' 7")	8090mm(26' 7")
Max digging depth (8ft level)	B'	6240mm(20' 6")	6630mm(21' 9")	7300mm(23' 11")	7920mm(25' 12")
Max vertical wall digging depth	C	6000mm(19' 8")	5850mm(19' 2")	6410mm(21' 0")	7080mm(23' 3")
Max digging height	D	10070mm(33' 0")	10110mm(33' 2")	10160mm(33' 4")	10360mm(33' 12")
Max dumping height	E	6940mm(22' 9")	7030mm(23' 1")	7110mm(23' 4")	7310mm(23' 12")
Min swing radius	F	4380mm(14' 4")	4260mm(13' 12")	4230mm(13' 11")	4140mm(13' 7")
Bucket digging force	SAE	169[184] kN	169[184] kN	169[184] kN	169[184] kN
		17200[18760] kgf	17200[18760] kgf	17200[18760] kgf	17200[18760] kgf
		37920[41370] lbf	37920[41370] lbf	37920[41370] lbf	37920[41370] lbf
	ISO	192[210] kN	192[210] kN	192[210] kN	192[210] kN
		19600[21380] kgf	19600[21380] kgf	19600[21380] kgf	19600[21380] kgf
		43210[47140] lbf	43210[47140] lbf	43210[47140] lbf	43210[47140] lbf
Arm crowd force	SAE	170[185] kN	147[161] kN	124[135] kN	109[119] kN
		17300[18870] kgf	15000[16360] kgf	12600[13750] kgf	11100[12110] kgf
		38140[41610] lbf	33070[36080] lbf	27780[30310] lbf	24470[26690] lbf
	ISO	178[194] kN	154[168] kN	129[140] kN	112[122] kN
		18100[19750] kgf	15700[17130] kgf	13100[14290] kgf	11400[12440] kgf
		39900[43530] lbf	34610[37760] lbf	28880[31510] lbf	25130[27410] lbf

[ ] : Power boost

## 4. WEIGHT

### 1) R290LC-7A, R290NLC-7A

Item	R290LC-7A		R290NLC-7A	
	kg	lb	kg	lb
Upperstructure assembly	12610	27800	←	←
Main frame weld assembly	2361	5210	←	←
Engine assembly	556	1230	←	←
Main pump assembly	155	340	←	←
Main control valve assembly	200	442	←	←
Swing motor assembly	311	687	←	←
Hydraulic oil tank assembly	227	500	←	←
Fuel tank assembly	209	460	←	←
Counterweight	5200	11460	←	←
Cab assembly	310	680	←	←
Lower chassis assembly	10740	23680	10600	23370
Track frame weld assembly	3765	8300	3625	7990
Swing bearing	410	910	←	←
Travel motor assembly	360	790	←	←
Turning joint	54	120	←	←
Track recoil spring and idler	457	1010	←	←
Idler	252	560	←	←
Carrier roller	40	88	←	←
Track roller	54	119	←	←
Track-chain assembly (600mm standard triple grouser shoe)	1860	4110	←	←
Front attachment assembly(6.25m boom, 3.05m arm,1.27m <sup>3</sup> SAE heaped bucket)	5550	12240	←	←
6.25m boom assembly	2200	4860	←	←
3.05m arm assembly	1025	2260	←	←
1.27m <sup>3</sup> SAE heaped bucket	1010	2230	←	←
Boom cylinder assembly	290	640	←	←
Arm cylinder assembly	375	826	←	←
Bucket cylinder assembly	250	551	←	←
Bucket control rod assembly	112	248	←	←

## 2) R290LC-7A LONG REACH

Item	R290LC-7A LONG REACH	
	kg	lb
Upperstructure assembly	14410	31810
Main frame weld assembly	2361	5210
Engine assembly	556	1230
Main pump assembly	155	340
Main control valve assembly	200	442
Swing motor assembly	311	687
Hydraulic oil tank assembly	227	500
Fuel tank assembly	209	460
Counterweight	7000	15450
Cab assembly	310	680
Lower chassis assembly	10900	24030
Track frame weld assembly	3765	8300
Swing bearing	410	910
Travel motor assembly	360	790
Turning joint	54	120
Track recoil spring and idler	457	1010
Idler	252	560
Carrier roller	40	88
Track roller	54	119
Track-chain assembly(800mm standard triple grouser shoe)	2020	4450
Front attachment assembly(10.2m boom, 7.85m arm, 0.51m <sup>3</sup> SAE heaped bucket)	5920	13050
10.2m boom assembly	2960	6530
7.85m arm assembly	1340	2960
0.52m <sup>3</sup> SAE heaped bucket	460	1010
Boom cylinder assembly	290	640
Arm cylinder assembly	375	826
Bucket cylinder assembly	96	212
Bucket control rod assembly	112	248



### 3) R290LC-7A HIGH WALKER

Item	R290LC-7A HIGH WALKER	
	kg	lb
Upperstructure assembly	12610	27800
Main frame weld assembly	2361	5210
Engine assembly	556	1230
Main pump assembly	155	340
Main control valve assembly	200	442
Swing motor assembly	311	687
Hydraulic oil tank assembly	227	500
Fuel tank assembly	209	460
Counterweight	5200	11460
Cab assembly	310	680
Lower chassis assembly	12800	28220
Track frame weld assembly	5825	12840
Swing bearing	410	910
Travel motor assembly	360	790
Turning joint	54	120
Track recoil spring and idler	457	1010
Idler	252	560
Carrier roller	40	88
Track roller	54	119
Track-chain assembly(600mm standard triple grouser shoe)	1860	4110
Front attachment assembly(6.25m boom, 3.05m arm, 1.27m <sup>3</sup> SAE heaped bucket)	5550	12240
6.25m boom assembly	2200	4860
3.05m arm assembly	1025	2260
1.27m <sup>3</sup> SAE heaped bucket	1010	2230
Boom cylinder assembly	290	640
Arm cylinder assembly	375	826
Bucket cylinder assembly	250	551
Bucket control rod assembly	112	248











## 5. LIFTING CAPACITIES

### 1) R290LC-7A

(1) 6.25m(20' 6") boom, 2.10m(6' 11") arm equipped with 1.27m<sup>3</sup>(PCSA heaped) bucket and 600mm (24") triple grouser shoe.













•  : Rating over-front

•  : Rating over-side or 360 degree















Load point height		Load radius								At max. reach		
		3.0m(10ft)		4.5m(15ft)		6.0m(20ft)		7.5m(25ft)		Capacity		Reach m(ft)
												
7.5m (25ft)	kg lb					*5760 *12700	*5760 *12700			*5290 *11660	4580 10100	8.01 (26.3)
6.0m (20ft)	kg lb					*6090 *13430	*6090 *13430	*5900 *13010	4950 10910	*5380 *11860	3670 8090	8.90 (29.2)
4.5m (15ft)	kg lb			*8940 *19710	*8940 *19710	*7040 *15520	*7040 *15520	*6210 *13690	4820 10630	5270 11620	3200 7050	9.42 (30.9)
3.0m (10ft)	kg lb			*11660 *25710	10180 22440	*8270 *18230	6600 14550	*6800 *14990	4610 10160	4990 11000	2990 6590	9.64 (31.6)
1.5m (5ft)	kg lb			*13520 *29810	9490 20920	*9370 *20660	6210 13690	7330 16160	4400 9700	4980 10980	2970 6550	9.58 (31.4)
Ground Line	kg lb			*14060 *31000	9290 20480	*10020 *22090	5980 13180	7180 15830	4270 9410	5260 11600	3140 6920	9.23 (30.3)
-1.5m (-5ft)	kg lb	*13470 *29700	*13470 *29700	*13770 *30360	9310 20530	*10110 *22290	5920 13050	7150 15760	4240 9350	5970 13160	3590 7910	8.57 (28.1)
-3.0m (-10ft)	kg lb	*17570 *38740	*17570 *38740	*12710 *28020	9480 20900	*9440 *20810	6020 13270			*6180 *13620	4610 10160	7.47 (24.5)
-4.5m (-15ft)	kg lb	*14150 *31200	*14150 *31200	*10330 *22770	9880 21780							

- Note
1. Lifting capacity are based on SAE J1097 and ISO 10567.
  2. Lifting capacity of the ROBEX series does not exceed 75% of tipping load with the machine on firm, level ground or 87% of full hydraulic capacity.
  3. The load point is a hook located on the back of the bucket.
  4. \*indicates load limited by hydraulic capacity.















(2) 6.25m(20' 6") boom, 2.50m(8' 2") arm equipped with 1.27m<sup>3</sup>(SAE heaped) bucket and 600mm (24") triple grouser shoe.

Load point height		Load radius										At max. reach			
		1.5m(5ft)		3.0m(10ft)		4.5m(15ft)		6.0m(20ft)		7.5m(25ft)		Capacity		Reach	
														m(ft)	
7.5m (25ft)	kg lb												*4880 *10760	4330 9550	8.34 (27.4)
6.0m (20ft)	kg lb									*5470 *12060	5060 11160		*5020 *11070	3510 7740	9.19 (30.2)
4.5m (15ft)	kg lb					*8180 18030	*8180 *18030	*6610 *14570	*6610 *14570	*5880 *12960	4900 10800		5070 11180	3080 6790	9.69 (31.8)
3.0m (10ft)	kg lb					*10910 *24050	10440 23020	*7890 *17390	6700 14770	*6530 *14400	4660 10270		4790 10560	2870 6330	9.90 (32.5)
1.5m (5ft)	kg lb					*13040 *28750	9630 21230	*9080 *20020	6270 13820	*7190 *15850	4430 9770		4770 10520	2840 6260	9.84 (32.3)
Ground Line	kg lb					*13950 *30750	9310 20530	9870 *21760	6000 13230	7180 15830	4270 9410		5000 11020	2980 6570	9.51 (31.2)
-1.5m (-5ft)	kg lb			*14370 *31680	*14370 *31680	*13930 *30710	9260 20410	*10120 *22310	5900 13010	7110 15670	4210 9280		5610 12370	3360 7410	8.87 (29.1)
-3.0m (-10ft)	kg lb	*16270 *35870	*16270 *35870	*18700 *41230	*18700 *41230	*13110 *28900	9390 20700	*9690 *21360	5950 13120				*6310 *13910	4210 9280	7.82 (25.7)
-4.5m (-15ft)	kg lb			*15620 *34440	*15620 *34440	*11170 *24630	9720 21430								

(3) 6.25m(20' 6") boom, 3.05m(10' 0") arm equipped with 1.27m<sup>3</sup>(SAE heaped) bucket and 600mm (24") triple grouser shoe.

Load point height		Load radius											At max. reach			
		1.5m(5ft)		3.0m(10ft)		4.5m(15ft)		6.0m(20ft)		7.5m(25ft)		9.0m(30ft)		Capacity		Reach
																m(ft)
7.5m (25ft)	kg lb													*4460 *9830	3830 8440	8.94 (29.3)
6.0m (20ft)	kg lb									*4910 *10820	*4910 *10820			*4600 *10140	3160 6970	9.74 (32.0)
4.5m (15ft)	kg lb							*5960 *13140	*5960 *13140	*5390 *11880	4950 10910			4640 10230	2790 6150	10.20 (33.5)
3.0m (10ft)	kg lb			*9910 *21850	*9910 *21850	*9820 *21650	*9820 *21650	*7280 *16050	6780 14950	*6090 *13430	4690 10340	*4140 *9130	3380 7450	4400 9700	2610 5750	10.40 (34.1)
1.5m (5ft)	kg lb					*12250 *27010	9780 21560	*8590 *18940	6310 13910	*6830 *15060	4430 9770	*4900 *10800	3240 7140	4360 9610	2560 5640	10.35 (34.0)
Ground Line	kg lb			*9590 *21140	*9590 *21140	*13580 *29940	9290 20480	*9550 *21050	5980 13180	7150 15760	4230 9330	*4310 *9500	3140 6920	4550 10030	2670 5890	10.04 (32.9)
-1.5m (-5ft)	kg lb	*10390 *22910	*10390 *22910	*13470 *29700	*13470 *29700	*13920 *30690	9140 20150	*10000 *22050	5820 12830	7030 15500	4130 9110			5020 11070	2970 6550	9.44 (31.0)
-3.0m (-10ft)	kg lb	*14060 *31000	*14060 *31000	*18180 *40080	*18180 *40080	*13440 *29630	9200 20280	9830 21670	5810 12810	7050 15540	4150 9150			*5980 *13180	3610 7960	8.48 (27.8)
-4.5m (-15ft)	kg lb	*18380 *40520	*18380 *40520	*17190 *37900	*17190 *37900	*11970 *26390	9450 20830	*8750 *19290	5990 13210					*5960 *13140	5120 11290	6.97 (22.9)











(4) 6.25m(20' 6") boom, 3.75m(12' 4") arm equipped with 1.27m<sup>3</sup>(SAE heaped) bucket and 600mm (24") triple grouser shoe.

Load point height		Load radius												At max. reach			
		1.5m(5ft)		3.0m(10ft)		4.5m(15ft)		6.0m(20ft)		7.5m(25ft)		9.0m(30ft)		Capacity		Reach	
																	m(ft)
7.5m (25ft)	kg lb														*3930 *8660	3310 7300	9.67 (31.7)
6.0m (20ft)	kg lb								*4160 *9170	*4160 *9170	*2370 *5220	*2370 *5220	*4090 *9020	2770 6110	10.40 (34.1)		
4.5m (15ft)	kg lb								*4710 *10380	*4710 *10380	*3720 *8200	3550 7830	4160 9170	2460 5420	10.83 (35.5)		
3.0m (10ft)	kg lb			*13490 *29740	*13490 *29740	*8320 *18340	*8320 *18340	*6410 *14130	*6410 *14130	*5470 *12060	4760 10490	*4740 *10450	3400 7500	3950 8710	2300 5070	11.02 (36.2)	
1.5m (5ft)	kg lb			*9980 *22000	*9980 *22000	*11050 *24360	10090 22240	*7850 *17310	6420 14150	*6300 *13890	4470 9850	*5440 *11990	3240 7140	3920 8640	2260 4980	10.97 (36.0)	
Ground Line	kg lb	*6470 *14260	*6470 *14260	*10300 *22710	*10300 *22710	*12890 *28420	9400 20720	*9020 *19890	6010 13250	*7030 *15500	4220 9300	5300 11680	3100 6830	4050 8930	2330 5140	10.68 (35.0)	
-1.5m (-5ft)	kg lb	*9310 *20530	*9310 *20530	*12760 *28130	*12760 *28130	*13720 *30250	9090 20040	*9730 *21450	5770 12720	6970 15370	4070 8970	5210 11490	3020 6660	4410 9720	2560 5640	10.12 (33.2)	
-3.0m (-10ft)	kg lb	*12290 *27090	*12290 *27090	*16240 *35800	*16240 *35800	*13690 *30180	9040 19930	*9880 *21780	5700 12570	6920 15260	4020 8360			5140 11330	3030 6680	9.25 (30.3)	
-4.5m (-15ft)	kg lb	*15740 *34700	*15740 *34700	*18940 *41760	18940 41760	*12770 *28150	9190 20260	*9310 *20530	5780 12740					*5780 *12740	4030 8880	7.92 (26.0)	

## 2) R290NLC-7A













(1) 6.25m(20' 6") boom, 2.10m(6' 11") arm equipped with 1.27m<sup>3</sup>(SAE heaped) bucket and 600mm (24") triple grouser shoe.

-  : Rating over-front
-  : Rating over-side or 360 degree















Load point height		Load radius								At max. reach		
		3.0m(10ft)		4.5m(15ft)		6.0m(20ft)		7.5m(25ft)		Capacity		Reach
												m(ft)
7.5m (25ft)	kg lb					*5760 *12700	*5760 *12700			*5290 *11660	4140 9130	8.01 (26.3)
6.0m (20ft)	kg lb					*6090 *13430	*6090 *13430	*5900 *13010	4470 9850	*5380 *11860	3300 7280	8.90 (29.2)
4.5m (15ft)	kg lb			*8940 *19710	*8940 *19710	*7040 *15520	6390 14090	*6210 *13690	4350 9590	5250 11570	2860 6310	9.42 (30.9)
3.0m (10ft)	kg lb			*11660 *25710	9090 20040	*8270 *18230	5930 13070	*6800 *14990	4140 9130	4960 10930	2660 5860	9.64 (31.6)
1.5m (5ft)	kg lb			*13520 *29810	8420 18560	*9370 *20660	5550 12240	7290 16070	3940 8690	4950 10910	2640 5820	9.58 (31.4)
Ground Line	kg lb			*14060 *31000	8220 18120	*10020 *22090	5330 11750	7140 15740	3800 8380	5230 11530	2790 6150	9.23 (30.3)
-1.5m (-5ft)	kg lb	*13470 *29700	*13470 *29700	*13770 *30360	8240 18170	*10110 *22290	5270 11620	7110 15670	3780 8330	5930 13070	3210 7080	8.57 (28.1)
-3.0m (-10ft)	kg lb	*17570 *38740	*17290 *38120	*12710 *28020	8410 18540	*9440 *20810	5370 11840			*6180 *13620	4130 9110	7.47 (24.5)
-4.5m (-15ft)	kg lb	*14150 *31200	*14150 *31200	*10330 *22770	8800 19400							

- Note
1. Lifting capacity are based on SAE J1097 and ISO 10567.
  2. Lifting capacity of the ROBEX series does not exceed 75% of tipping load with the machine on firm, level ground or 87% of full hydraulic capacity.
  3. The load point is a hook located on the back of the bucket.
  4. \*indicates load limited by hydraulic capacity.

















(2) 6.25m(20' 6") boom, 2.50m(8' 2") arm equipped with 1.27m<sup>3</sup>(SAE heaped) bucket and 600mm (24") triple grouser shoe.

Load point height		Load radius										At max. reach			
		1.5m(5ft)		3.0m(10ft)		4.5m(15ft)		6.0m(20ft)		7.5m(25ft)		Capacity		Reach	
														m(ft)	
7.5m (25ft)	kg lb												*4880 *10760	3920 8640	8.34 (27.4)
6.0m (20ft)	kg lb									*5470 *12060	4580 10100		*5020 *11070	3160 6970	9.19 (30.2)
4.5m (15ft)	kg lb					*8180 18030	*8180 *18030	*6610 *14570	6500 14330	*5880 *12960	4420 9740		5040 11110	2750 6060	9.69 (31.8)
3.0m (10ft)	kg lb					*10910 *24050	9330 20570	*7890 *17390	6030 13290	*6530 *14400	4190 9240		4760 10490	2550 5620	9.90 (32.5)
1.5m (5ft)	kg lb					*13040 *28750	8550 18850	*9080 *20020	5610 12370	*7190 *15850	3970 8750		4740 10450	2520 5560	9.84 (32.3)
Ground Line	kg lb					*13950 *30750	8240 18170	*9870 *21760	5350 11790	7140 15740	3810 8400		4970 10960	2640 5820	9.51 (31.2)
-1.5m (-5ft)	kg lb			*14370 *31680	*14370 *31680	*13930 *30710	8190 18060	10090 22240	5250 11570	7070 15590	3740 8250		5580 12300	2990 6590	8.87 (29.1)
-3.0m (-10ft)	kg lb	*16270 *35870	*16270 *35870	*18700 *41230	17040 37570	*13110 *28900	8310 18320	*9690 *21360	5300 11680				*6310 *13910	3770 8310	7.82 (25.7)
-4.5m (-15ft)	kg lb			*15620 *34440	*15620 *34440	*11170 *24630	8630 19030								

(3) 6.25m(20' 6") boom, 3.05m(10' 0") arm equipped with 1.27m<sup>3</sup>(SAE heaped) bucket and 600mm (24") triple grouser shoe.

Load point height		Load radius												At max. reach		
		1.5m(5ft)		3.0m(10ft)		4.5m(15ft)		6.0m(20ft)		7.5m(25ft)		9.0m(30ft)		Capacity		Reach
																m(ft)
7.5m (25ft)	kg lb													*4460 *9830	3460 7630	8.94 (29.3)
6.0m (20ft)	kg lb									*4910 *10820	4670 10300			*4600 *10140	2830 6240	9.74 (32.0)
4.5m (15ft)	kg lb							*5960 *13140	*5960 *13140	*5390 *11880	4480 9880			4610 10160	2480 5470	10.20 (33.5)
3.0m (10ft)	kg lb			*9910 *21850	*9910 *21850	*9820 *21650	9600 21160	*7280 *16050	6110 13470	*6090 *13430	4220 9300	*4140 *9130	3010 6640	4370 9630	2310 5090	10.40 (34.1)
1.5m (5ft)	kg lb					*12250 *27010	8690 19160	*8590 *18940	5650 12460	*6830 *15060	3960 8730	*4900 *10800	2880 6320	4340 9570	2270 5000	10.35 (34.0)
Ground Line	kg lb			*9590 *21140	*9590 *21140	*13580 *29940	8220 18120	*9550 *21050	5320 11730	7110 15670	3770 8310	*4310 *9500	2780 6130	4520 9960	2360 5200	10.04 (32.9)
-1.5m (-5ft)	kg lb	*10390 *22910	*10390 *22910	*13470 *29700	*13470 *29700	*13920 *30690	8080 17810	*10000 *22050	5170 11400	6990 15410	3660 8070			4990 11000	2630 5800	9.44 (31.0)
-3.0m (-10ft)	kg lb	*14060 *31000	*14060 *31000	*18180 *40080	16660 36730	*13440 *29630	8130 17920	*9830 *21670	5160 11380	7010 15450	3680 8110			*5980 *13180	3220 7100	8.48 (27.8)
-4.5m (-15ft)	kg lb	*18380 *40520	*18380 *40520	*17190 *37900	17140 37790	*11970 *26390	8370 18450	*8750 *19290	5330 11750					*5960 *13140	4600 10140	6.97 (22.9)













(4) 6.25m(20' 6") boom, 3.75m(12' 4") arm equipped with 1.27m<sup>3</sup>(SAE heaped) bucket and 600mm (24") triple grouser shoe.

Load point height		Load radius												At max. reach			
		1.5m(5ft)		3.0m(10ft)		4.5m(15ft)		6.0m(20ft)		7.5m(25ft)		9.0m(30ft)		Capacity		Reach	
																	
7.5m (25ft)	kg lb														*3930 *8660	2980 6570	9.67 (31.7)
6.0m (20ft)	kg lb									*4160 *9170	*4160 *9170	*2370 *5220	*2370 *5220	*4090 *9020	2470 5450	10.40 (34.1)	
4.5m (15ft)	kg lb									*4710 *10380	4560 10050	*3720 *8200	3180 7010	4140 9130	2180 4810	10.83 (35.5)	
3.0m (10ft)	kg lb			*13490 *29740	*13490 *29740	*8320 *18340	*8320 *18340	*6410 *14130	6280 13850	*5470 *12060	4280 9440	*4740 *10450	3030 6680	3930 8660	2020 4450	11.02 (36.2)	
1.5m (5ft)	kg lb			*9980 *22000	*9980 *22000	*11050 *24360	8990 19820	*7850 *17310	5760 12700	*6300 *13890	3990 8800	5420 11950	2870 6330	3890 8580	1980 4370	10.97 (36.0)	
Ground Line	kg lb	*6470 *14260	*6470 *14260	*10300 *22710	*10300 *22710	*12890 *28420	8320 18340	*9020 *19890	5360 11820	*7030 *15500	3750 8270	5270 11620	2740 6040	4030 8880	2040 4500	10.68 (35.0)	
-1.5m (-5ft)	kg lb	*9310 *20530	*9310 *20530	*12760 *28130	*12760 *28130	*13720 *30250	8020 17680	*9730 *21450	5120 11290	6930 15280	3600 7940	5180 11420	2660 5860	4380 9660	2250 4960	10.12 (33.2)	
-3.0m (-10ft)	kg lb	*12290 *27090	*12290 *27090	*16240 *35800	*16240 *35800	*13690 *30180	7970 17570	*9880 *21780	5050 11130	6880 15170	3550 7830			5110 11270	2680 5910	9.25 (30.3)	
-4.5m (-15ft)	kg lb	*15740 *34700	*15740 *34700	*18940 *41760	16670 36750	*12770 *28150	8120 17900	*9310 *20530	5120 11290					*5780 *12740	3590 7910	7.92 (26.0)	

### 3) R290LC-7A LONG REACH

(1) 10.2m(33' 6") boom, 7.85m(25' 9") arm equipped with 0.52m<sup>3</sup>(SAE heaped) bucket and 800mm (32") triple grouser shoe.

-  : Rating over-front
-  : Rating over-side or 360 degree

Load point height m(ft)		Load radius										At max. reach				
		3.0m(10.0ft)		6.0m(20.0ft)		9.0m(30.0ft)		12.0m(40.0ft)		15.0m(50.0ft)		Capacity		Reach m(ft)		
																
12.0m (40.0ft)	kg lb													*1630 *3590	*1630 *3590	15.27 (50.1)
9.0m (30.0ft)	kg lb									*1420 *3130	*1420 *3130	*1690 *3730	1600 3530	16.89 (55.4)		
6.0m (20.0ft)	kg lb									*1830 *4030	*1830 *4030	*1790 *3950	1310 2890	17.83 (58.5)		
3.0m (10.0ft)	kg lb					*3000 *6610	*3000 *6610	*2390 *5270	*2390 *5270	*2080 *4590	1830 4030	*1920 *4230	1150 2540	18.20 (59.7)		
Ground Line	kg lb	*3780 *8330	*3780 *8330	*6710 *14790	*6710 *14790	*4000 *8820	3900 8600	*2920 *6440	2480 5470	*2380 *5250	1630 3590	2070 4560	1100 2430	18.04 (59.2)		
-3.0m (-10.0ft)	kg lb	*5080 *11200	*5080 *11200	*7970 *17570	5900 13010	*4770 *10520	3370 7430	*3370 *7430	2190 4830	*2630 *5800	1480 3260	2170 4780	1140 2510	17.33 (56.9)		
-6.0m (-20.0ft)	kg lb	*6810 *15010	*6810 *15010	*8310 *18320	5710 12590	*5150 *11350	3160 6970	*3630 *8000	2050 4520	*2550 *5620	1430 3150	2470 5450	1330 2930	15.99 (52.5)		
-9.0m (-30.0ft)	kg lb	*8960 *19750	*8960 *19750	*7890 *17390	5920 13050	*5050 *11130	3210 7080	*3520 *7760	2100 4630			*2800 *6170	1800 3970	13.83 (45.4)		
-12.0m (-40.0ft)	kg lb	*11900 *26230	*11900 *26230	*6420 *14150	*6420 *14150	*4120 *9080	3560 7850									

- Note
1. Lifting capacity are based on SAE J1097 and ISO 10567.
  2. Lifting capacity of the ROBEX series does not exceed 75% of tipping load with the machine on firm, level ground or 87% of full hydraulic capacity.
  3. The load point is a hook located on the back of the bucket.
  4. \*indicates load limited by hydraulic capacity.













#### 4) R290LC-7A HIGH WALKER

(1) 6.25m(20' 6") boom, 2.10m(6' 11") arm equipped with 1.27m<sup>3</sup>(SAE heaped) bucket and 600mm (24") triple grouser shoe.













•  : Rating over-front

•  : Rating over-side or 360 degree













Load point height		Load radius								At max. reach		
		3.0m(10ft)		4.5m(15ft)		6.0m(20ft)		7.5m(25ft)		Capacity		Reach
												m(ft)
7.5m (25ft)	kg lb					*5750 *12680	*5750 *12680			*5300 *11680	5190 11440	8.21 (26.9)
6.0m (20ft)	kg lb					*6220 *13710	*6220 *13710	*5920 *13050	5880 12960	*5400 *11900	4290 9460	9.02 (29.6)
4.5m (15ft)	kg lb			*9430 *20790	*9430 *20790	*7260 *16010	*7260 *16010	*6310 *13910	5720 12610	*5560 *12260	3840 8470	9.48 (31.1)
3.0m (10ft)	kg lb			*12110 *26700	12050 26570	*8490 *18720	7800 17200	*6910 *15230	5500 12130	5540 12210	3640 8020	9.65 (31.7)
1.5m (5ft)	kg lb			*13700 *30200	11450 25240	*9530 *21010	7430 16380	*7490 *16510	5300 11680	5590 12320	3660 8070	9.54 (31.3)
Ground Line	kg lb			*14060 *31000	11290 24890	*10080 *22220	7230 15940	*7830 *17260	5180 11420	5970 13160	3910 8620	9.14 (30.0)
-1.5m (-5ft)	kg lb	*14990 *33050	*14990 *33050	*13640 *30070	11340 25000	*10050 *22160	7200 15870	*7690 *16950	5180 11420	*6270 *13820	4520 9960	8.40 (27.6)
-3.0m (-10ft)	kg lb	*17110 *37720	*17110 *37720	*12400 *27340	11560 25490	*9200 *20280	7340 16180			*6100 *13450	5900 13010	7.21 (23.7)
-4.5m (-15ft)	kg lb	*13230 *29170	*13230 *29170	*9610 *21190	*9610 *21190							

- Note
1. Lifting capacity are based on SAE J1097 and ISO 10567.
  2. Lifting capacity of the ROBEX series does not exceed 75% of tipping load with the machine on firm, level ground or 87% of full hydraulic capacity.
  3. The load point is a hook located on the back of the bucket.
  4. \*indicates load limited by hydraulic capacity.

















(2) 6.25m(20' 6") boom, 2.50m(8' 2") arm equipped with 1.27m<sup>3</sup>(SAE heaped) bucket and 600mm (24") triple grouser shoe.

Load point height		Load radius										At max. reach			
		1.5m(5ft)		3.0m(10ft)		4.5m(15ft)		6.0m(20ft)		7.5m(25ft)		Capacity		Reach	
														m(ft)	
7.5m (25ft)	kg lb												*4910 *10820	*4910 *10820	8.52 (28.0)
6.0m (20ft)	kg lb							*5770 *12720	*5770 *12720	*5520 *12170	*5520 *12170	*5060 *11160	4120 9080	9.30 (30.5)	
4.5m (15ft)	kg lb					*8660 *19090	*8660 *19090	*6830 *15060	*6830 *15060	*5990 *13210	5790 12760	*5240 *11550	3690 8140	9.75 (32.0)	
3.0m (10ft)	kg lb					*11380 *25090	*11380 *25090	*8130 *17920	7900 17420	*6650 *14660	5550 12240	5330 11750	3500 7720	9.91 (32.5)	
1.5m (5ft)	kg lb					*13300 *29320	11560 25490	*9260 *20410	7490 16510	*7300 *16090	5330 11750	5350 11790	3500 7720	9.80 (32.2)	
Ground Line	kg lb			*9530 *21010	*9530 *21010	*14010 *30890	11290 24890	*9960 *21960	7240 15960	*7730 *17040	5180 11420	5680 12520	3710 8180	9.42 (30.9)	
-1.5m (-5ft)	kg lb	*12300 *27120	*12300 *27120	*15460 *34080	*15460 *34080	*13840 *30510	11280 24870	*10100 *22270	7170 15810	*7780 *17150	5140 11330	*6210 *13690	4230 9330	8.71 (28.6)	
-3.0m (-10ft)	kg lb	*17240 *38010	*17240 *38010	*18270 *40280	*18270 *40280	*12870 *28370	11450 25240	*9510 *20970	7250 15980			*6300 *13890	5380 11860	7.58 (24.9)	
-4.5m (-15ft)	kg lb			*14820 *32670	*14820 *32670	*10610 *23390	*10610 *23390								

(3) 6.25m(20' 6") boom, 3.05m(10' 0") arm equipped with 1.27m<sup>3</sup>(SAE heaped) bucket and 600mm (24") triple grouser shoe.

Load point height		Load radius										At max. reach				
		1.5m(5ft)		3.0m(10ft)		4.5m(15ft)		6.0m(20ft)		7.5m(25ft)		9.0m(30ft)		Capacity		Reach
															m(ft)	
7.5m (25ft)	kg lb									*3300 *7280	*3300 *7280			*4480 *9880	4400 9700	9.12 (29.9)
6.0m (20ft)	kg lb									*4980 *10980	*4980 *10980			*4630 *10210	3730 8220	9.84 (32.3)
4.5m (15ft)	kg lb							*6180 *13620	*6180 *13620	*5510 *12150	*5510 *12150			*4820 *10630	3370 7430	10.26 (33.7)
3.0m (10ft)	kg lb					*10320 *22750	*10320 *22750	*7530 *16600	*7530 *16600	*6230 *13730	5580 12300	*2910 *6420	*2910 *6420	4900 10800	3200 7050	10.41 (34.2)
1.5m (5ft)	kg lb			*6850 *15100	*6850 *15100	*12580 *27730	11680 25750	*8790 *19380	7520 16580	*6950 *15320	5320 11730	*4340 *9570	4080 8990	4910 10820	3190 7030	10.31 (33.8)
Ground Line	kg lb			*10250 *22600	*10250 *22600	*13710 *30230	11260 24820	*9670 *21320	7210 15900	*7500 *16530	5140 11330	*4920 *10850	3950 8710	5160 11380	3350 7390	9.95 (32.6)
-1.5m (-5ft)	kg lb	*11020 *24290	*11020 *24290	*14240 *31390	*14240 *31390	*13900 *30640	11150 24580	*10020 *22090	7080 15610	*7720 *17020	5050 11130			5760 12700	3760 8290	9.29 (30.5)
-3.0m (-10ft)	kg lb	*14780 *32580	*14780 *32580	*19180 *42280	*19180 *42280	*13260 *29230	11240 24780	*9720 *21430	7100 15650	*7360 *16230	5100 11240			*6010 *13250	4610 10160	8.25 (27.1)
-4.5m (-15ft)	kg lb	*19280 *42510	*19280 *42510	*16520 *36420	*16520 *36420	*11550 *25460	11540 25440	*8370 *18450	7320 16140							

(4) 6.25m(20' 6") boom, 3.75m(12' 4") arm equipped with 1.27m<sup>3</sup>(SAE heaped) bucket and 600mm (24") triple grouser shoe.

Load point height		Load radius												At max. reach			
		1.5m(5ft)		3.0m(10ft)		4.5m(15ft)		6.0m(20ft)		7.5m(25ft)		9.0m(30ft)		Capacity		Reach	
																	
7.5m (25ft)	kg lb														*3960 *8730	3850 8490	9.83 (32.3)
6.0m (20ft)	kg lb									*4240 *9350	*4240 *9350	*2680 *5910	*2680 *5910	*4120 *9080	3310 7300	10.50 (34.4)	
4.5m (15ft)	kg lb									*4830 *10650	4830 10650	*3910 *8620	*3910 *8620	*4310 *9500	3000 6610	10.89 (35.7)	
3.0m (10ft)	kg lb			*14870 *32780	*14870 *32780	*8850 *19510	*8850 *19510	*6680 *14730	*6680 *14730	*5620 *12390	*5620 *12390	*4930 *10870	4100 9040	4420 9740	2850 6280	11.03 (36.2)	
1.5m (5ft)	kg lb			*9690 *21360	*9690 *21360	*11460 *25260	*11460 *25260	*8090 *17840	7620	*6450	5350	*5530	3940	4420	2830	10.93	
Ground Line	kg lb	*6990 *15410	*6990 *15410	*10660 *23500	*10660 *23500	*13120 *28920	11340 25000	*9190 *20260	7230 15940	*7130 *15720	5120 11290	5910 13030	3810 8400	4610 10160	2950 6500	10.60 (34.8)	
<del>1.5m (-5ft)</del>	<del>kg lb</del>	<del>*9830 *21670</del>	<del>*9830 *21670</del>	<del>*13320 *29370</del>	<del>*13320 *29370</del>	<del>*13780 *30380</del>	<del>11080 24430</del>	<del>*9800 *21610</del>	<del>7020 15480</del>	<del>*7550 *16640</del>	<del>4980 10980</del>	<del>*4790 *10560</del>	<del>3740 8250</del>	<del>5060 11160</del>	<del>3260 7190</del>	<del>9.99 (32.8)</del>	
<del>3.0m (-10ft)</del>	<del>kg lb</del>	<del>*12870 *28370</del>	<del>*12870 *28370</del>	<del>*16990 *37460</del>	<del>*16990 *37460</del>	<del>*13590 *29960</del>	<del>11060 24380</del>	<del>*9840 *21690</del>	<del>6970 15370</del>	<del>*7530 *16600</del>	<del>4950 10910</del>			<del>*5610 *12370</del>	<del>3880 8550</del>	<del>9.04 (29.7)</del>	

## 6. BUCKET SELECTION GUIDE

### 1) GENERAL BUCKET

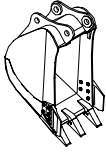
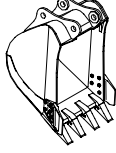
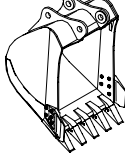
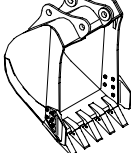
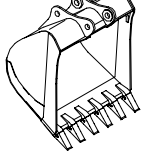
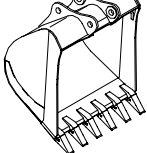
					
0.79m <sup>3</sup> SAE heaped bucket	1.03m <sup>3</sup> SAE heaped bucket	※ 1.27m <sup>3</sup> SAE heaped bucket	1.50m <sup>3</sup> SAE heaped bucket	1.73m <sup>3</sup> SAE heaped bucket	1.85m <sup>3</sup> SAE heaped bucket

Capacity		Width		Weight	Recommendation			
SAE heaped	CECE heaped	Without side cutter	With side cutter		6.25m (20' 6") boom			
					2.1m arm (6' 11")	2.5m arm (8' 2")	3.05m arm (10' 0")	3.75m arm (12' 4")
0.79m <sup>3</sup> (1.03yd <sup>3</sup> )	0.70m <sup>3</sup> (0.92yd <sup>3</sup> )	890mm (35.0")	1010mm (39.8")	790kg (1740lb)				
1.03m <sup>3</sup> (1.35yd <sup>3</sup> )	0.90m <sup>3</sup> (1.18yd <sup>3</sup> )	1090mm (42.9")	1210mm (47.6")	890kg (1960lb)				
※ 1.27m <sup>3</sup> (1.66yd <sup>3</sup> )	1.10m <sup>3</sup> (1.44yd <sup>3</sup> )	1290mm (50.8")	1410mm (55.5")	1010kg (2230lb)				
1.50m <sup>3</sup> (1.96yd <sup>3</sup> )	1.30m <sup>3</sup> (1.70yd <sup>3</sup> )	1490mm (58.7")	1610mm (63.4")	1080kg (2380lb)				
1.73m <sup>3</sup> (2.26yd <sup>3</sup> )	1.50m <sup>3</sup> (1.96yd <sup>3</sup> )	1700mm (66.9")	1820mm (71.7")	1170kg (2580lb)				
1.85m <sup>3</sup> (2.42yd <sup>3</sup> )	1.60m <sup>3</sup> (2.09yd <sup>3</sup> )	1800mm (70.9")	1920mm (75.6")	1230kg (2710lb)				

※ : Standard bucket

 Applicable for materials with density of 2000kgf/m<sup>3</sup> (3370lbf/yd<sup>3</sup>) or less

 Applicable for materials with density of 1600kgf/m<sup>3</sup> (2700lbf/yd<sup>3</sup>) or less

 Applicable for materials with density of 1100kgf/m<sup>3</sup> (1850lbf/yd<sup>3</sup>) or less

## 2) ROCK AND HEAVY DUTY BUCKET

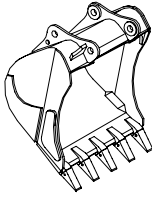
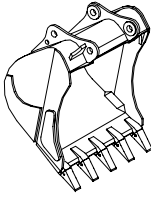
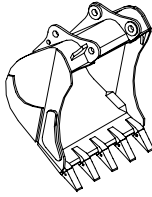
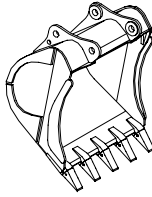
			
<p>◆ 1.07m<sup>3</sup> SAE ◆ 1.15m<sup>3</sup> SAE heaped bucket</p>	<p>◆ 1.27m<sup>3</sup> SAE heaped bucket</p>	<p>◆ 1.46m<sup>3</sup> SAE heaped bucket</p>	<p>⊙ 1.16m<sup>3</sup> SAE ⊙ 1.49m<sup>3</sup> SAE heaped bucket</p>

Capacity		Width		Weight	Recommendation			
SAE heaped	CECE heaped	Without side cutter	With side cutter		6.25m (20' 6") boom			
					2.1m arm (6' 11")	2.5m arm (8' 2")	3.05m arm (10' 0")	3.75m arm (12' 4")
◆ 1.07m <sup>3</sup> (1.40yd <sup>3</sup> )	0.95m <sup>3</sup> (1.24yd <sup>3</sup> )	1150mm (45.3")	-	1120kg (2470lb)				
◆ 1.15m <sup>3</sup> (1.50yd <sup>3</sup> )	1.00m <sup>3</sup> (1.31yd <sup>3</sup> )	1210mm (47.6")	-	1160kg (2560lb)				
◆ 1.27m <sup>3</sup> (1.66yd <sup>3</sup> )	1.10m <sup>3</sup> (1.44yd <sup>3</sup> )	1310mm (51.6")	-	1210kg (2670lb)				
◆ 1.46m <sup>3</sup> (1.91yd <sup>3</sup> )	1.28m <sup>3</sup> (1.67yd <sup>3</sup> )	1460mm (57.5")	-	1290kg (2840lb)				
1.16m <sup>3</sup> (1.52yd <sup>3</sup> )	1.00m <sup>3</sup> (1.31yd <sup>3</sup> )	1340mm (52.8")	-	1280kg (2820lb)				
1.49m <sup>3</sup> (1.95yd <sup>3</sup> )	1.28m <sup>3</sup> (1.67yd <sup>3</sup> )	1620mm (63.8")	-	1440kg (3170lb)				

◆ : Heavy duty bucket

⊙ : Rock bucket

 Applicable for materials with density of 2000kg/m<sup>3</sup> (3370lb/yd<sup>3</sup>) or less

 Applicable for materials with density of 1600kg/m<sup>3</sup> (2700lb/yd<sup>3</sup>) or less

 Applicable for materials with density of 1100kg/m<sup>3</sup> (1850lb/yd<sup>3</sup>) or less

## 7. UNDERCARRIAGE

### 1) TRACKS

X-leg type center frame is integrally welded with reinforced box-section track frames. The design includes dry tracks, lubricated rollers, idlers, sprockets, hydraulic track adjusters with shock absorbing springs and assembled track-type tractor shoes with triple grousers.

### 2) TYPES OF SHOES

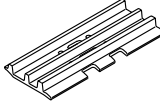
Model	Shapes		Triple grouser			
						
R290LC-7A	Shoe width	mm(in)	600(24)	700(28)	800(32)	900(36)
	Operating weight	kg(lb)	29300(64600)	29880(65870)	30460(67150)	31040(68430)
	Ground pressure	kgf/cm <sup>2</sup> (psi)	0.56(7.97)	0.49(6.97)	0.44(6.26)	0.38(5.40)
	Overall width	mm(ft-in)	3200(10' 6")	3300(10' 10")	3400(11' 1")	3500(11' 5")
R290NLC-7A	Shoe width	mm(in)	600(24)	-	-	-
	Operating weight	kg(lb)	29100(64150)	-	-	-
	Ground pressure	kgf/cm <sup>2</sup> (psi)	0.55(7.82)	-	-	-
	Overall width	mm(ft-in)	2990( 9'10")	-	-	-
R290LC-7A LONG REACH	Shoe width	mm(in)	-	-	800(32)	-
	Operating weight	kg(lb)	-	-	31890(70310)	-
	Ground pressure	kgf/cm <sup>2</sup> (psi)	-	-	0.44(6.26)	-
	Overall width	mm(ft-in)	-	-	3400(11' 2")	-
R290LC-7A HIGH WALKER	Shoe width	mm(in)	600(24)	700(28)	800(32)	Double Grouser 710(28)
	Operating weight	kg(lb)	32140(70860)	32720(72140)	33300(73410)	33310(73440)
	Ground pressure	kgf/cm <sup>2</sup> (psi)	0.62(8.82)	0.54(7.68)	0.48(6.83)	0.54(7.68)
	Overall width	mm(ft-in)	3470(11' 5")	3570(11' 9")	3670(12' 0")	3580(11' 9")

### 3) NUMBER OF ROLLERS AND SHOES ON EACH SIDE

Item	Quantity
Carrier rollers	2EA
Track rollers	9EA
Track shoes	48EA

#### 4) SELECTION OF TRACK SHOE

Suitable track shoes should be selected according to operating conditions.

##### Method of selecting shoes

Confirm the category from the list of applications in **table 2**, then use **table 1** to select the shoe. Wide shoes(Categories B and C) have limitations on applications. Before using wide shoes, check the precautions, then investigate and study the operating conditions to confirm if these shoes are suitable.

Select the narrowest shoe possible to meet the required flotation and ground pressure. Application of wider shoes than recommendations will cause unexpected problem such as bending of shoes, crack of link, breakage of pin, loosening of shoe bolts and the other various problems.

※ **Table 1**

Track shoe	Specification	Category
600mm triple grouser	Standard	A
700mm triple grouser	Option	B
710mm double grouser	Option	B
800mm triple grouser	Option	C
900mm triple grouser	Option	C
800mm triple grouser(Long reach)	Standard	C

※ **Table 2**

Category	Applications	Precautions
A	Rocky ground, river beds, normal soil	<ul style="list-style-type: none"> <li>Travel at low speed on rough ground with large obstacles such as boulders or fallen trees</li> </ul>
B	Normal soil, soft ground	<ul style="list-style-type: none"> <li>These shoes cannot be used on rough ground with large obstacles such as boulders or fallen trees</li> <li>Travel at high speed only on flat ground</li> <li>Travel slowly at low speed if it is impossible to avoid going over obstacles</li> </ul>
C	Extremely soft ground (Swampy ground)	<ul style="list-style-type: none"> <li>Use the shoes only in the conditions that the machine sinks and it is impossible to use the shoes of category A or B</li> <li>These shoes cannot be used on rough ground with large obstacles such as boulders or fallen trees</li> <li>Travel at high speed only on flat ground</li> <li>Travel slowly at low speed if it is impossible to avoid going over obstacles</li> </ul>

## 8. SPECIFICATIONS FOR MAJOR COMPONENTS

### 1) ENGINE

Item	Specification
Model	Cummins QSB6.7
Type	4-cycle turbocharged diesel engine
Cooling method	Water cooling
Number of cylinders and arrangement	6 cylinders, in-line
Firing order	1-5-3-6-2-4
Combustion chamber type	Direct injection type
Cylinder bore × stroke	104 × 132(4.09" × 5.20")
Piston displacement	6700cc(409cu in)
Compression ratio	17.2 : 1
Rated gross horse power(SAE J1995)	227Hp at 1900rpm(169kW at 1900rpm)
Maximum torque	96.8kgf · m(700lbf · ft) at 1400rpm
Engine oil quantity	24 l (6.3U.S. gal)
Dry weight	556kg(1226lb)
High idling speed	2050+ 50rpm
Low idling speed	950± 100rpm
Rated fuel consumption	167g/Hp · hr at 1900rpm
Starting motor	Delco Remy 24V-4.5kW
Alternator	Delco Remy 24V-50A
Battery	2 × 12V × 160Ah

### 2) MAIN PUMP

Item	Specification
Type	Variable displacement tandem axis piston pumps
Capacity	2 × 140cc/rev
Maximum pressure	330kgf/cm <sup>2</sup> (4690psi)[360kgf/cm <sup>2</sup> (5120psi)]
Rated oil flow	2 × 252 l /min (66.6U.S. gpm/ 55.4U.K. gpm)
Rated speed	1800rpm

[ ]: Power boost



### 3) GEAR PUMP

Item	Specification
Type	Fixed displacement gear pump single stage
Capacity	15cc/rev
Maximum pressure	35kgf/cm <sup>2</sup> (500psi)
Rated oil flow	27 l /min(7.1U.S. gpm/5.9U.K. gpm)

### 4) MAIN CONTROL VALVE

Item	Specification
Type	10 spools
Operating method	Hydraulic pilot system
Main relief valve pressure	330kgf/cm <sup>2</sup> (4690psi) [360kgf/cm <sup>2</sup> (5120psi)]
Overload relief valve pressure	390kgf/cm <sup>2</sup> (5550psi)

[ ]: Power boost

### 5) SWING MOTOR

Item	Specification
Type	Axial piston motor
Capacity	169.4cc/rev
Relief pressure	265kgf/cm <sup>2</sup> (3770psi)
Braking system	Automatic, spring applied hydraulic released
Braking torque	70kgf · m(506lbf · ft)
Brake release pressure	26kgf/cm <sup>2</sup> (370psi)
Reduction gear type	2 - stage planetary

### 6) TRAVEL MOTOR

Item	Specification
Type	Variable displacement axial piston motor
Relief pressure	330kgf/cm <sup>2</sup> (4693psi)
Capacity(max / min)	154.8/88.5cc/rev
Reduction gear type	3-stage planetary
Braking system	Automatic, spring applied hydraulic released
Brake release pressure	9kgf/cm <sup>2</sup> (128psi)
Braking torque	40kgf · m(290lbf · ft)

### 3) GEAR PUMP

Item	Specification
Type	Fixed displacement gear pump single stage
Capacity	15cc/rev
Maximum pressure	35kgf/cm <sup>2</sup> (500psi)
Rated oil flow	27 l /min(7.1U.S. gpm/5.9U.K. gpm)

### 4) MAIN CONTROL VALVE

Item	Specification	
	R290LC-7A	R290LC-7A Long reach
Type	10 spools	
Operating method	Hydraulic pilot system	
Main relief valve pressure	330kgf/cm <sup>2</sup> (4695psi) [360kgf/cm <sup>2</sup> (5120psi) ]	
Overload relief valve pressure	Boom	390kgf/cm <sup>2</sup> (5550psi)
	Arm	390kgf/cm <sup>2</sup> (5550psi)
	Bucket	390kgf/cm <sup>2</sup> (5550psi)
		390kgf/cm <sup>2</sup> (5550psi)
		In : 230kgf/cm <sup>2</sup> (3270psi) Out : 260kgf/cm <sup>2</sup> (3700psi)
		270kgf/cm <sup>2</sup> (3840psi)

[ ]: Power boost

### 5) SWING MOTOR

Item	Specification
Type	Axial piston motor
Capacity	169.4cc/rev
Relief pressure	265kgf/cm <sup>2</sup> (3770psi)
Braking system	Automatic, spring applied hydraulic released
Braking torque	70kgf · m(506lbf · ft)
Brake release pressure	26kgf/cm <sup>2</sup> (370psi)
Reduction gear type	2 - stage planetary

### 6) TRAVEL MOTOR

Item	Specification
Type	Variable displacement axial piston motor
Relief pressure	330kgf/cm <sup>2</sup> (4693psi)
Capacity(max / min)	154.8/88.5cc/rev
Reduction gear type	3-stage planetary
Braking system	Automatic, spring applied hydraulic released
Brake release pressure	9kgf/cm <sup>2</sup> (128psi)
Braking torque	40kgf · m(290lbf · ft)

## 7) REMOTE CONTROL VALVE

Item		Specification
Type		Pressure reducing type
Operating pressure	Minimum	6.5kgf/cm <sup>2</sup> (92psi)
	Maximum	26kgf/cm <sup>2</sup> (370psi)
Single operation stroke	Lever	61mm(2.4in)
	Pedal	123mm(4.84in)

## 8) CYLINDER

Item		Specification
Boom cylinder	Bore dia × Rod dia × Stroke	∅ 140 × ∅ 100 × 1465mm
	Cushion	Extend only
Arm cylinder	Bore dia × Rod dia × Stroke	∅ 150 × ∅ 110 × 1765mm
	Cushion	Extend and retract
Bucket cylinder	Bore dia × Rod dia × Stroke	∅ 140 × ∅ 95 × 1185mm
	Cushion	Extend only
Bucket cylinder (LONG REACH)	Bore dia × Rod dia × Stroke	∅ 100 × ∅ 70 × ∅ 870
	Cushion	Extend only

※ Discoloration of cylinder rod can occur when the friction reduction additive of lubrication oil spreads on the rod surface.

※ Discoloration does not cause any harmful effect on the cylinder performance.

## 9) SHOE

Item		Width	Ground pressure	Link quantity	Overall width
R290LC-7A	Standard	600mm(24")	0.56kgf/cm <sup>2</sup> (7.97psi)	48	3200mm(10' 6")
	Option	700mm(28")	0.49kgf/cm <sup>2</sup> (6.97psi)	48	3300mm(10' 10")
		800mm(32")	0.44kgf/cm <sup>2</sup> (6.26psi)	48	3400mm(11' 1")
		900mm(36")	0.38kgf/cm <sup>2</sup> (5.40psi)	48	3500mm(11' 5")
R290NLC-7A	Standard	600mm(24")	0.55kgf/cm <sup>2</sup> (7.82psi)	48	2990mm(9' 10")
R290LC-7A LONG REACH	Standard	800mm(32")	0.44kgf/cm <sup>2</sup> (6.26psi)	48	3400mm(11' 2")
R290LC-7A HIGH WALKER	Standard	600mm(24")	0.62kgf/cm <sup>2</sup> (8.82psi)	48	3470mm(11' 5")
	Option	700mm(28")	0.54kgf/cm <sup>2</sup> (7.68psi)	48	3570mm(11' 9")
		800mm(32")	0.48kgf/cm <sup>2</sup> (6.83psi)	48	3670mm(12' 0")
		★710mm(28")	0.54kgf/cm <sup>2</sup> (7.68psi)	48	3580mm(11' 9")

★ : Double grouser.

## 10) BUCKET

Item		Capacity		Tooth quantity	Width		
		SAE heaped	CECE heaped		Without side cutter	With side cutter	
R290LC-7A R290NLC-7A H/WALKER	Standard	1.27m <sup>3</sup> (1.66yd <sup>3</sup> )	1.10m <sup>3</sup> (1.44yd <sup>3</sup> )	5	1290mm(50.8")	1410mm(55.5")	
	Option	◆	0.79m <sup>3</sup> (1.03yd <sup>3</sup> )	0.70m <sup>3</sup> (0.92yd <sup>3</sup> )	3	890mm(35.0")	1010mm(39.8")
		◆	1.03m <sup>3</sup> (1.35yd <sup>3</sup> )	0.90m <sup>3</sup> (1.18yd <sup>3</sup> )	4	1090mm(42.9")	1210mm(47.6")
		◆	◆1.07m <sup>3</sup> (1.40yd <sup>3</sup> )	0.95m <sup>3</sup> (1.24yd <sup>3</sup> )	5	1150mm(45.3")	-
		◆	◆1.27m <sup>3</sup> (1.66yd <sup>3</sup> )	1.10m <sup>3</sup> (1.44yd <sup>3</sup> )	5	1210mm(47.6")	-
		◆	◆1.46m <sup>3</sup> (1.91yd <sup>3</sup> )	1.28m <sup>3</sup> (1.67yd <sup>3</sup> )	5	1460mm(57.5")	-
		⊙	⊙1.16m <sup>3</sup> (1.52yd <sup>3</sup> )	1.00m <sup>3</sup> (1.05yd <sup>3</sup> )	5	1340mm(52.8")	-
		⊙	⊙1.49m <sup>3</sup> (1.95yd <sup>3</sup> )	1.28m <sup>3</sup> (1.67yd <sup>3</sup> )	5	1620mm(63.8")	-
		◆	1.50m <sup>3</sup> (1.96yd <sup>3</sup> )	1.30m <sup>3</sup> (1.70yd <sup>3</sup> )	6	1490mm(58.7")	1610mm(63.4")
		◆	1.73m <sup>3</sup> (2.26yd <sup>3</sup> )	1.50m <sup>3</sup> (1.96yd <sup>3</sup> )	6	1700mm(66.9")	1820mm(71.7")
		◆	1.85m <sup>3</sup> (2.42yd <sup>3</sup> )	1.60m <sup>3</sup> (2.09yd <sup>3</sup> )	5	1800mm(70.9")	1920mm(75.6")
LONG REACH	Standard	0.52m <sup>3</sup> (0.68yd <sup>3</sup> )	0.46m <sup>3</sup> (0.60yd <sup>3</sup> )	5	935mm(36.8")	1035mm(40.8")	

◆ : Heavy duty bucket

⊙ : Rock bucket

## 9. RECOMMENDED OILS

Use only oils listed below or equivalent.

Do not mix different brand oil.

Service point	Kind of fluid	Capacity l (U.S. gal)	Ambient temperature °C (°F)								
			-20 (-4)	-10 (14)	0 (32)	10 (50)	20 (68)	30 (86)	40 (104)		
Engine oil pan	Engine oil	24(6.3)					SAE 30				
			SAE 10W								
			SAE 10W-30								
						SAE 15W-40					
Swing drive	Gear oil	11(2.9)					SAE 85W-140				
Final drive		5.5 × 2 (1.5 × 2)									
Hydraulic tank	Hydraulic oil	Tank; 210(55.5)	ISO VG 32								
		System; 320(84.5)	ISO VG 46								
			ISO VG 68								
Fuel tank	Diesel fuel	480(126.8)	ASTM D975 NO.1								
			ASTM D975 NO.2								
Fitting (Grease nipple)	Grease	As required	NLGI NO.1								
			NLGI NO.2								
Radiator (Reservoir tank)	Mixture of antifreeze and water 50 : 50	50(13.2)	Ethylene glycol base permanent type								

**SAE** : Society of Automotive Engineers

**API** : American Petroleum Institute

**ISO** : International Organization for Standardization

**NLGI** : National Lubricating Grease Institute

**ASTM** : American Society of Testing and Material