

SECTION 3 HYDRAULIC SYSTEM

Group 1 Hydraulic Circuit	3-1
Group 2 Main Circuit	3-2
Group 3 Pilot Circuit	3-5
Group 4 Single Operation	3-10
Group 5 Combined Operation	3-22

SECTION 3 HYDRAULIC SYSTEM

GROUP 1 HYDRAULIC CIRCUIT

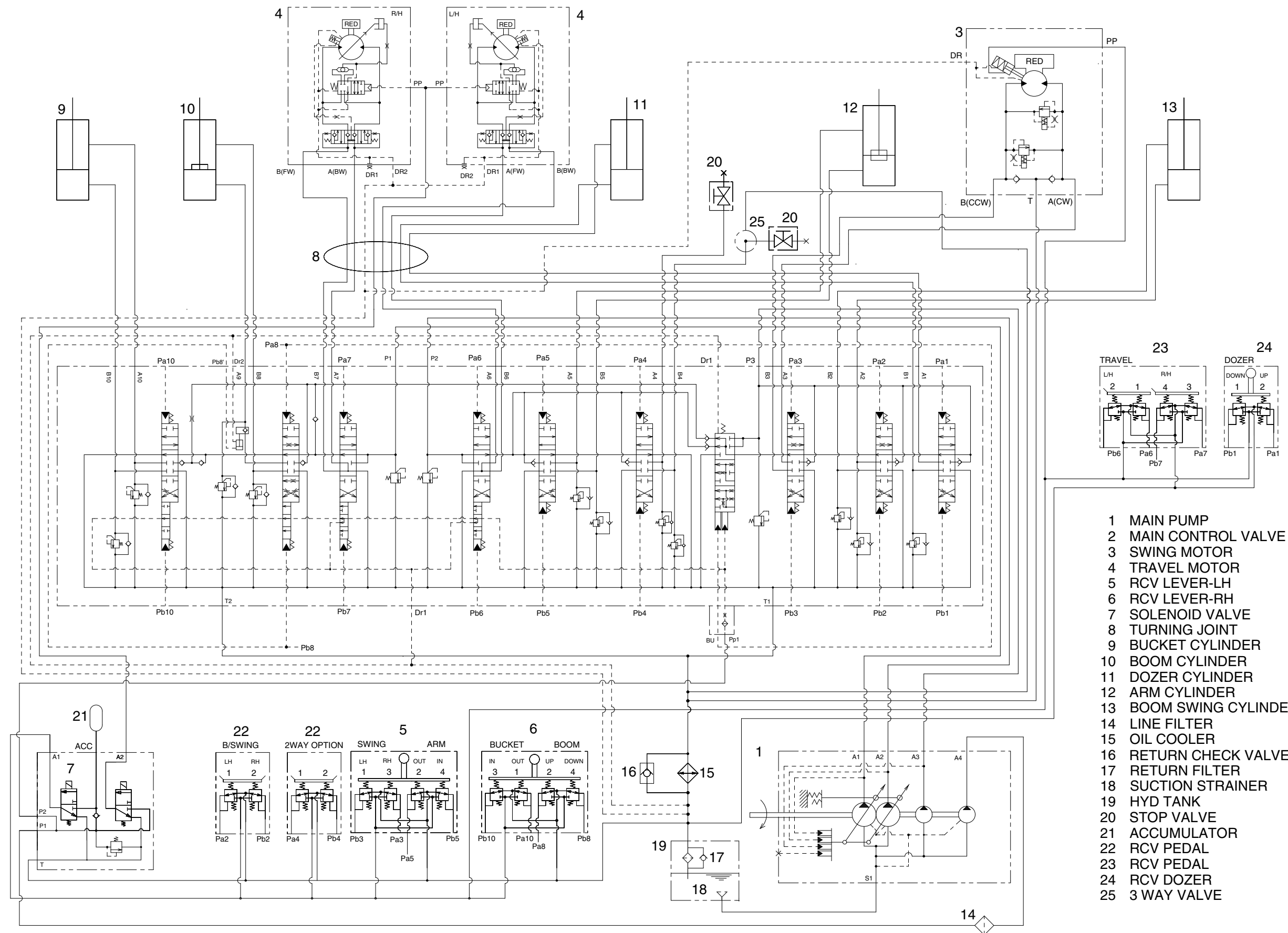

- 1 MAIN PUMP
- 2 MAIN CONTROL VALVE
- 3 SWING MOTOR
- 4 TRAVEL MOTOR
- 5 RCV LEVER-LH
- 6 RCV LEVER-RH
- 7 SOLENOID VALVE
- 8 TURNING JOINT
- 9 BUCKET CYLINDER
- 10 BOOM CYLINDER
- 11 DOZER CYLINDER
- 12 ARM CYLINDER
- 13 BOOM SWING CYLINDER
- 14 LINE FILTER
- 15 OIL COOLER
- 16 RETURN CHECK VALVE
- 17 RETURN FILTER
- 18 SUCTION STRAINER
- 19 HYD TANK
- 20 STOP VALVE
- 21 ACCUMULATOR
- 22 RCV PEDAL
- 23 RCV PEDAL
- 24 RCV DOZER
- 25 3 WAY VALVE

R27Z93HC01

GROUP 2 MAIN CIRCUIT

The main hydraulic circuit consists of suction circuit, delivery circuit, return circuit and drain circuit. The hydraulic system consists of one main pump, one control valve, one swing motor, four cylinders and two travel motors.

The swash plate type variable displacement axial piston pump is used as the main pump and is driven by the engine at ratio 1.0 of engine speed.

1. SUCTION AND DELIVERY CIRCUIT

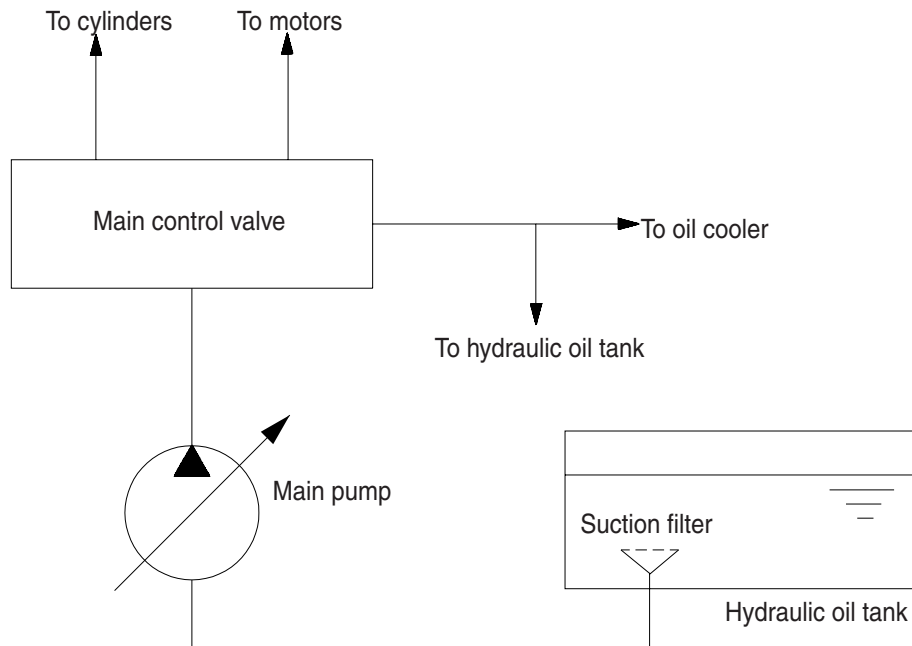

3-02 (140-7 TIER)

The pumps receive oil from the hydraulic tank through a suction filter. The discharged oil from the pump flows into the control valve and goes out the tank ports.

The oil discharged from the main pump flows to the actuators through the control valve.

The control valve controls the hydraulic functions.

The return oil from the actuators flows to the hydraulic tank through the control valve and the oil cooler.

2. RETURN CIRCUIT

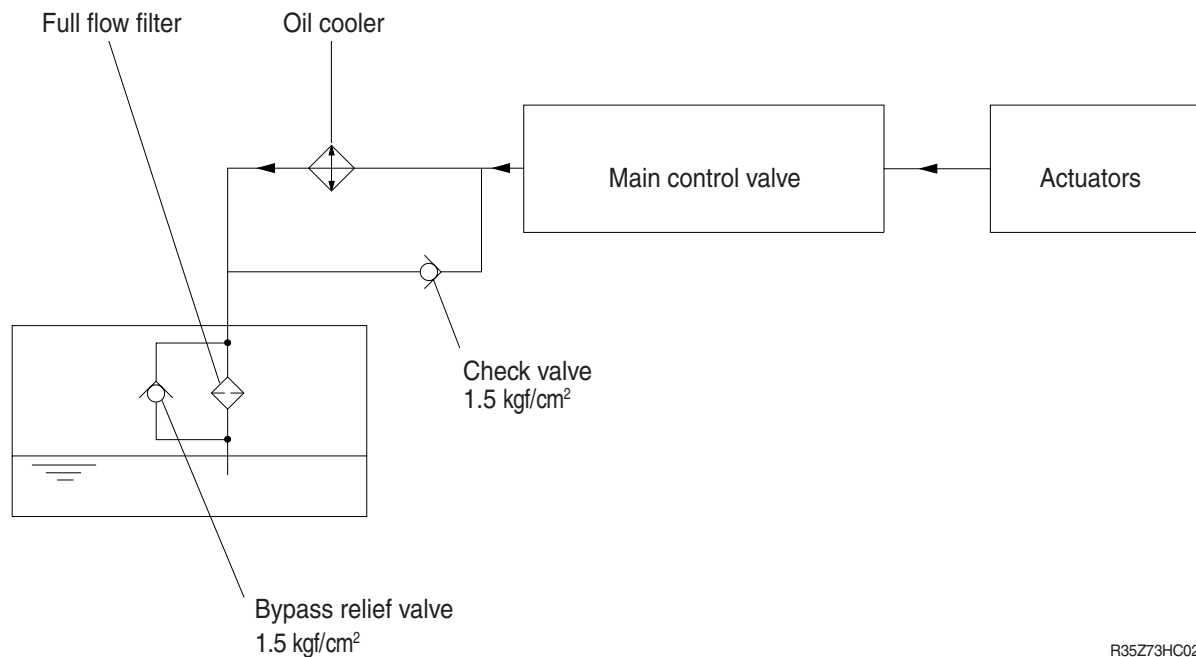

R35Z73HC02

All oil returned from each actuator returns to the hydraulic tank through the control valve.

The bypass check valves are provided in the return circuit.

The setting pressure of bypass check valves are 1.5 kgf/cm² (21 psi). Usually, oil returns to the hydraulic tank from the left side of control valve through oil cooler.

When oil temperature is low, viscosity becomes higher and flow resistance increases when passing through the oil cooler. When the oil pressure exceeds 1.5 kgf/cm² (21 psi), the oil returns directly to the hydraulic tank, resulting in the oil temperature being raised quickly at an appropriate level.

When the oil cooler is clogged, the oil returns directly to the hydraulic tank through bypass check valve.

The full-flow filter and bypass relief valve are provided in the hydraulic tank.

The oil returned from right and left side of control valve is combined and filtered by the full-flow filter. A bypass relief valve is provided in the full-flow filter.

When the filter element is clogged, the bypass relief valve opens at 1.5 kgf/cm² (21 psi) differential pressure.

3. DRAIN CIRCUIT

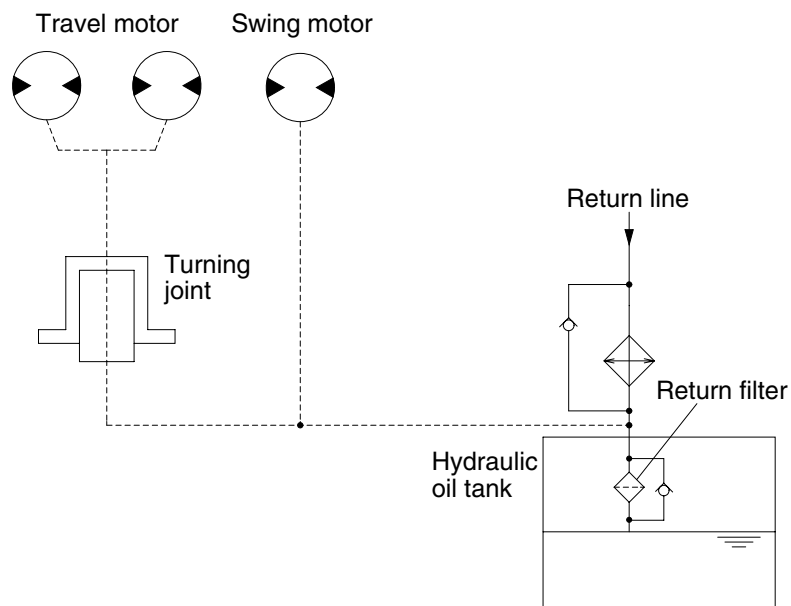

R35Z73HC43

Besides internal leaks from the motors and main pump, the oil for lubrication circulates.

1) TRAVEL MOTOR DRAIN CIRCUIT

Oil leaked from the right and left travel motors comes out of the drain ports provided in the respective motor casing and join with each other. These oils pass through the turning joint and return to the hydraulic tank after being filtered by return filter.

2) SWING MOTOR DRAIN CIRCUIT

Oil leaked from the swing motor returns to the hydraulic tank passing through a return filter with oil drained from the travel circuit .

GROUP 3 PILOT CIRCUIT

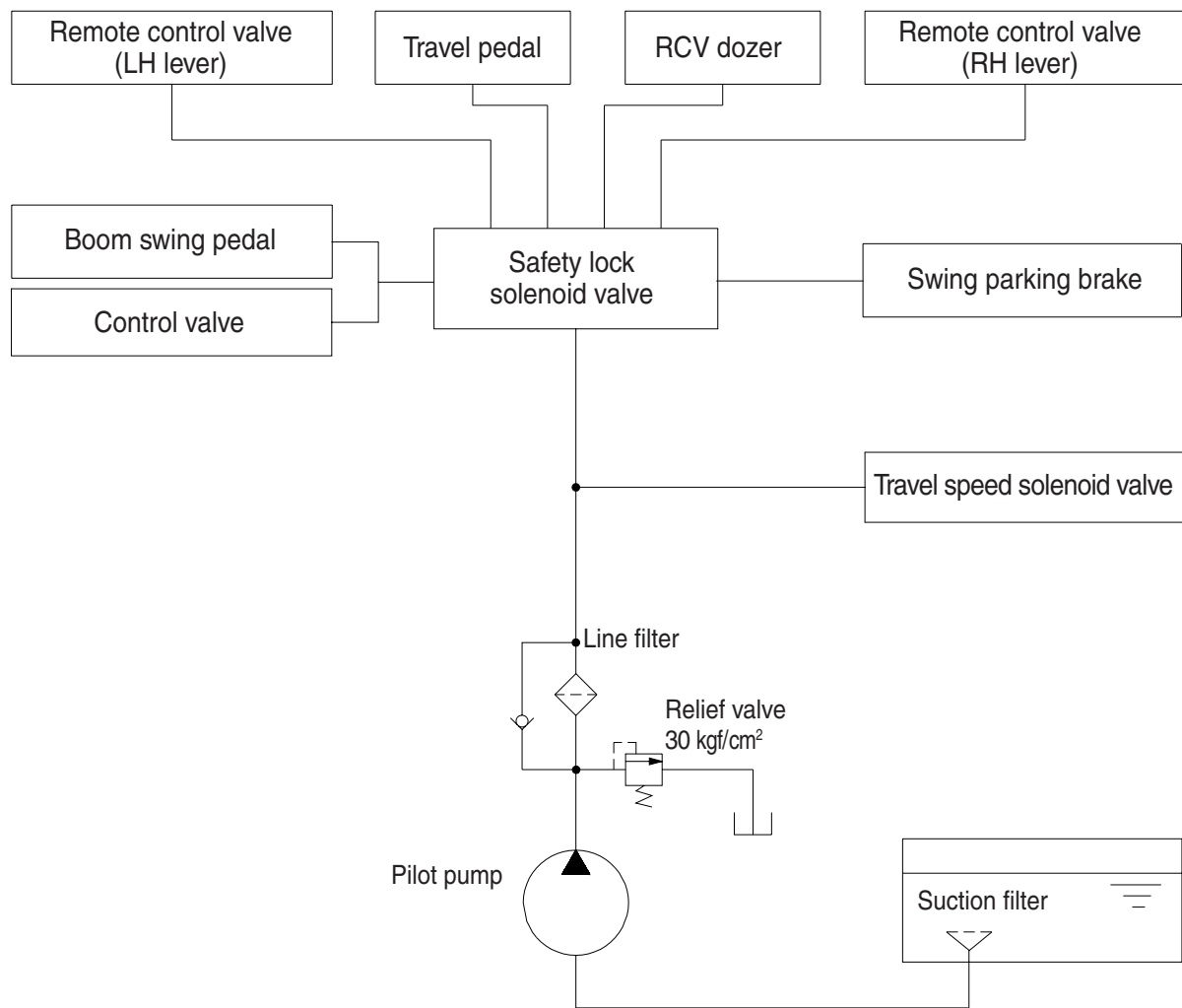

R35Z73HC00

The pilot circuit consists of suction circuit, delivery circuit and return circuit.

The pilot pump is provided with relief valve, receives the oil from the hydraulic tank through the suction filter.

The discharged oil from the pilot pump flows to the remote control valve through line filter, solenoid valve assemblies, swing parking brake, main control valve and safety lock solenoid valve.

1. SUCTION, DELIVERY AND RETURN CIRCUIT

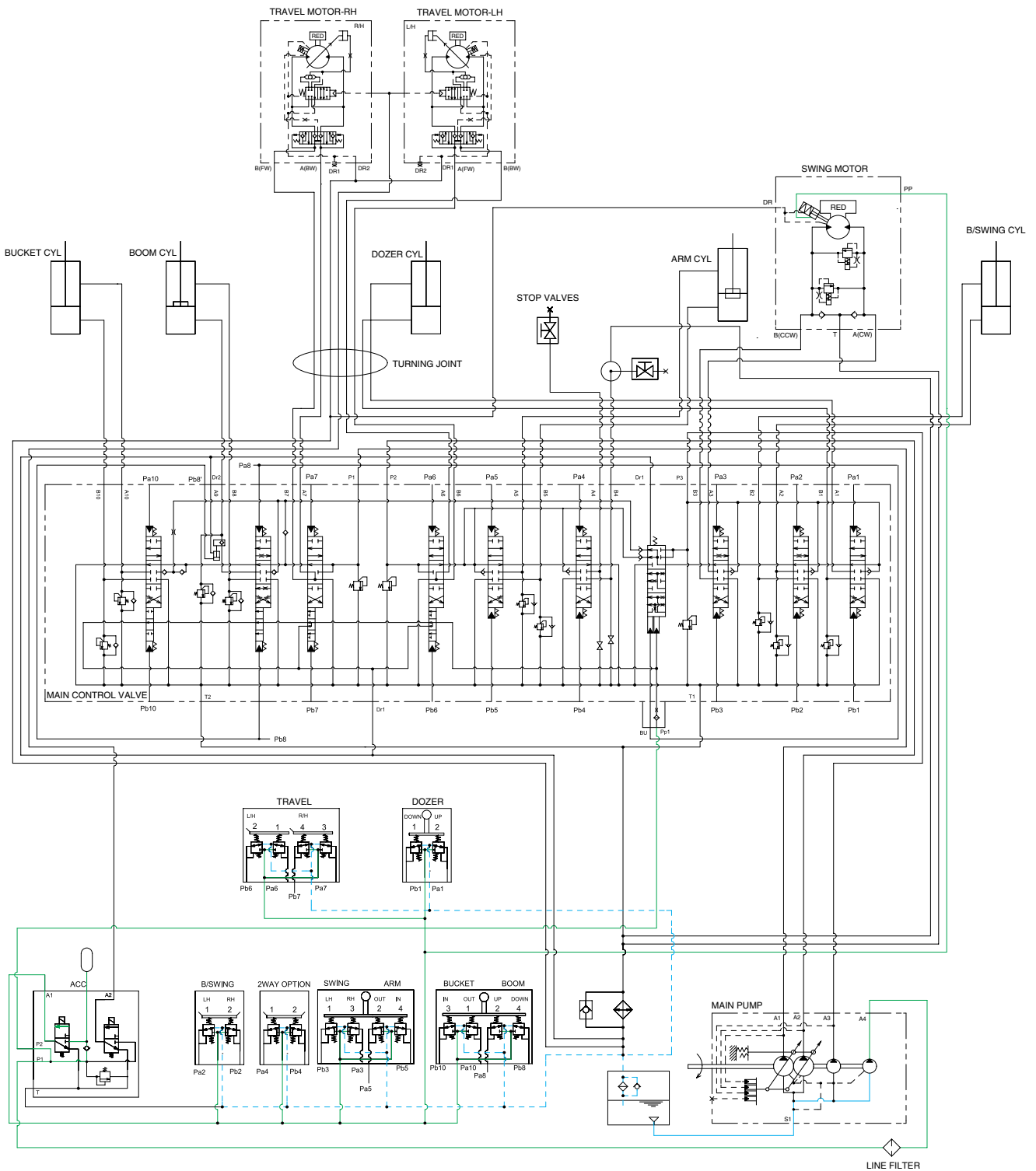

R27293HC03

The pilot pump receive oil from the hydraulic tank. The discharged oil from the pilot pump flows to the safety solenoid valve through the line filter. The oil is filtered by the line filter. The pilot relief valve is provided in the pilot pump for limiting the pilot circuit pressure.

The oil filtered by line filter flows remote control valve, MCV and swing port through safety solenoid valve.

The return oil flow into the hydraulic tank.

2. SAFETY VALVE (SAFETY LEVER)

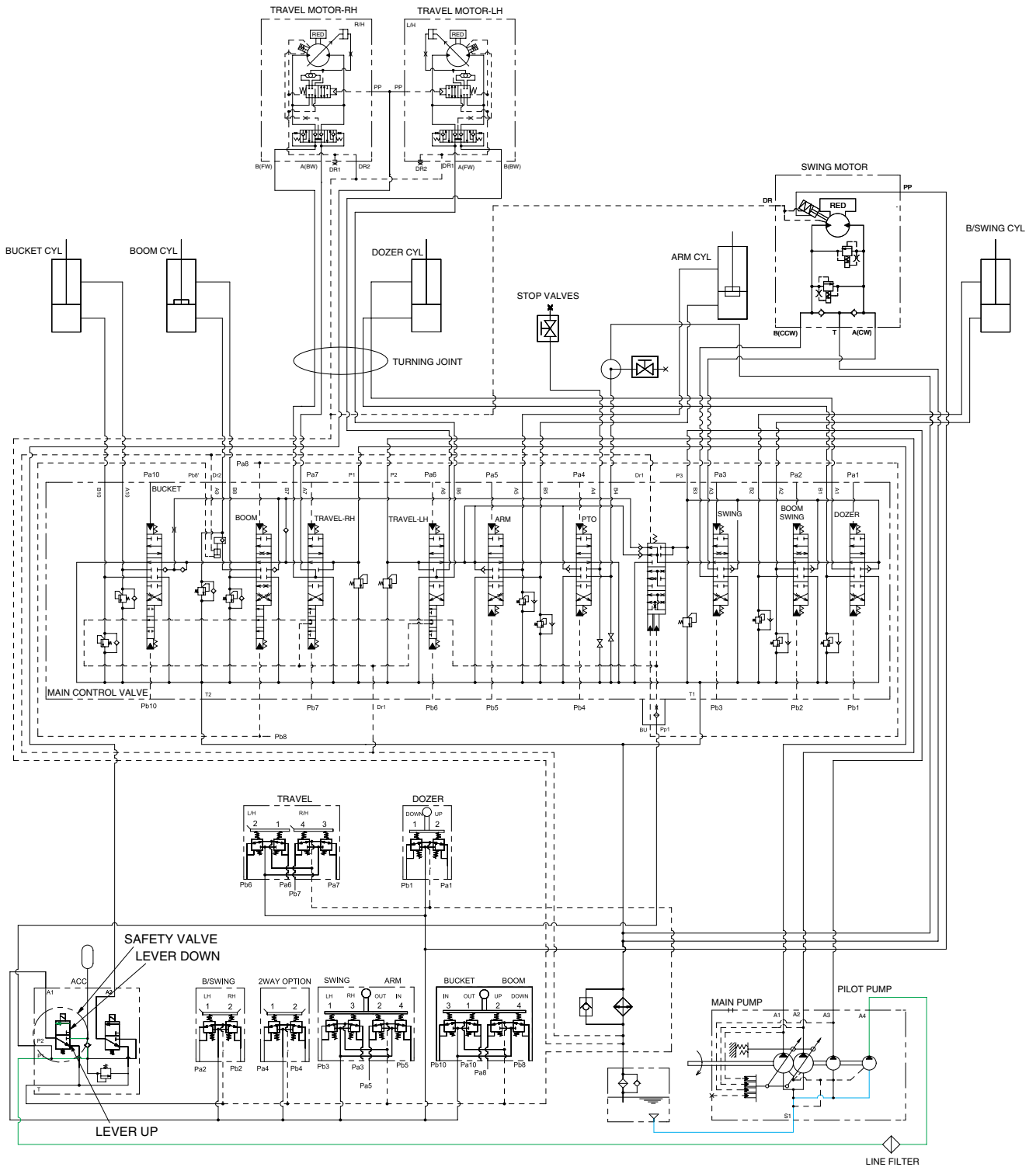

R27Z93HC04

When the lever of the safety solenoid valve is moved downward, oil flows into the remote control valve through solenoid valve and line filter.

When the lever of the safety solenoid valve is moved upward, oil does not flow into the remote control valve, because of the blocked port.

3. TRAVEL SPEED CONTROL SYSTEM

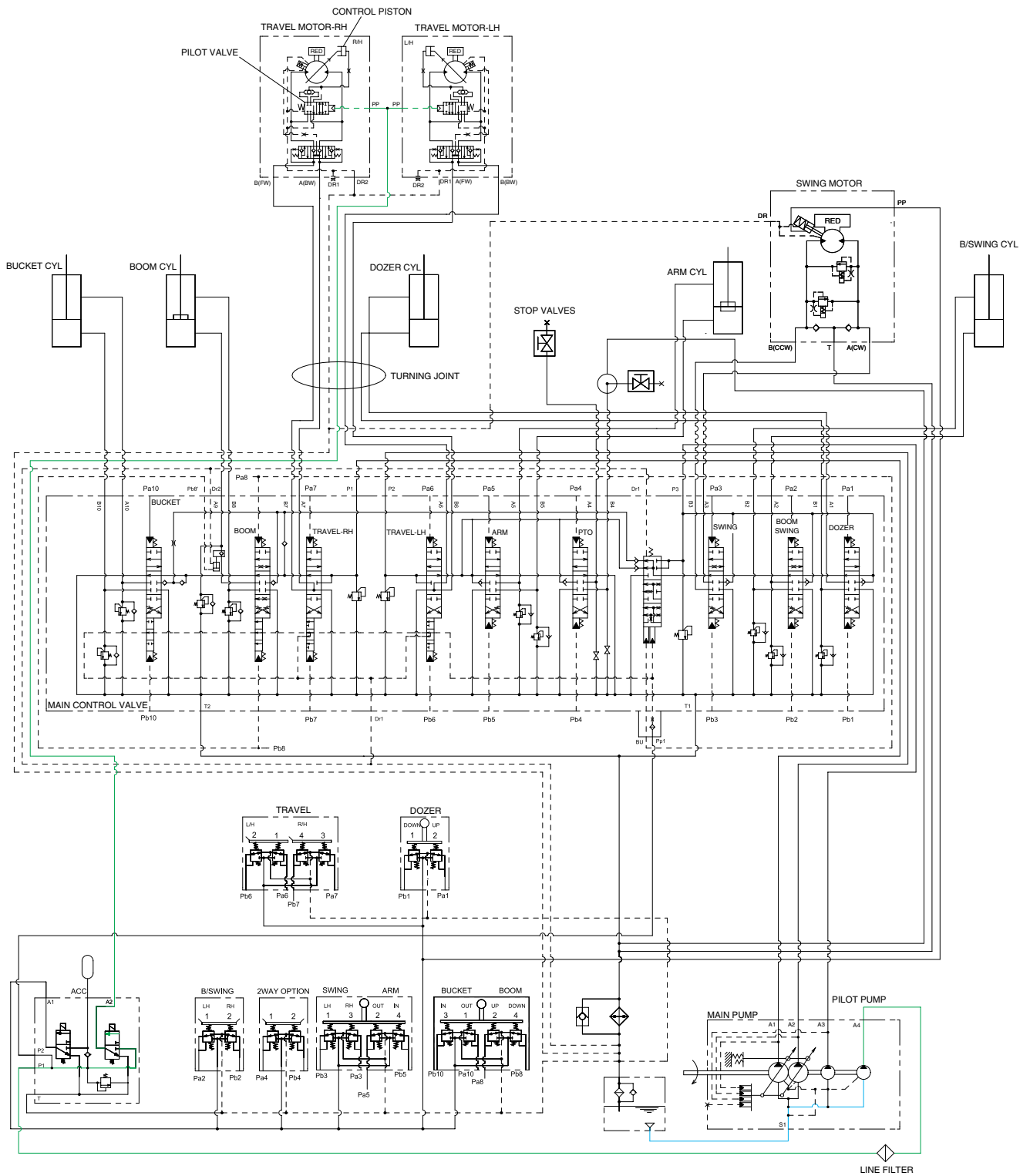

R27Z93HC05

When the travel speed switch is pushed, the travel speed solenoid valve is actuated and the discharged oil from the pilot pump flows to the Ps port of pilot valve in the travel motors. As a result, the control piston is pushed by the main oil flow, thus the displacement is minimized. When the travel speed switch is pushed once more, the travel speed solenoid valve is return to original position by the force of spring, the hydraulic oil of Ps port returns to the hydraulic tank. As a result, the control piston is returned by the main oil flow, thus the displacement is maximized.

4. SWING PARKING BRAKE RELEASE

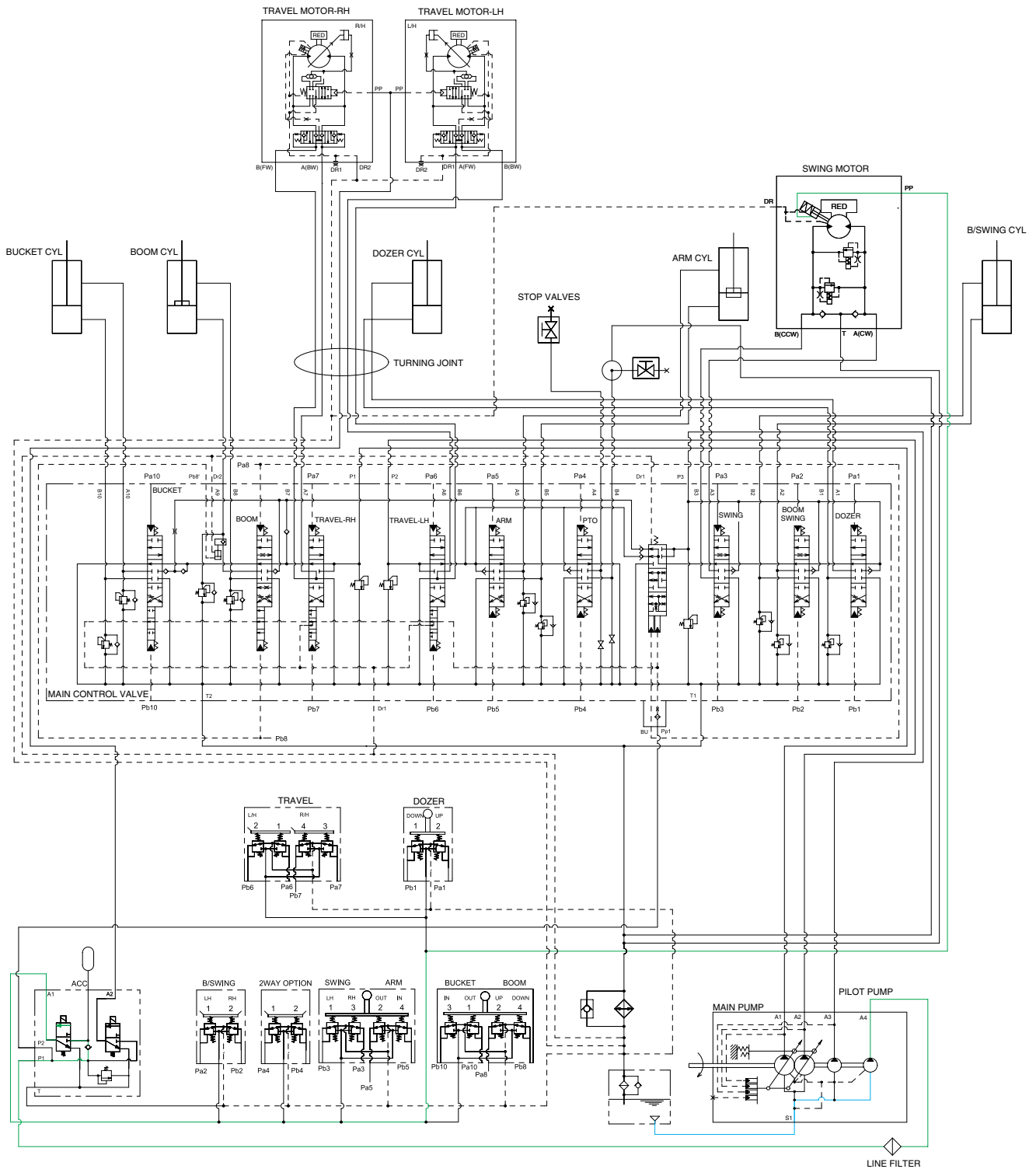

R27Z93HC06

When the Safety solenoid lever is moved downward, the pilot oil flow into PP port of the swing motor through solenoid valve. This pressure is applied to swing motor disc, thus the brake is released. When the safety solenoid lever is moved to upward, oil in the swing motor disc cylinder is drained, thus the brake is applied.

GROUP 4 SINGLE OPERATION

1. BOOM UP OPERATION

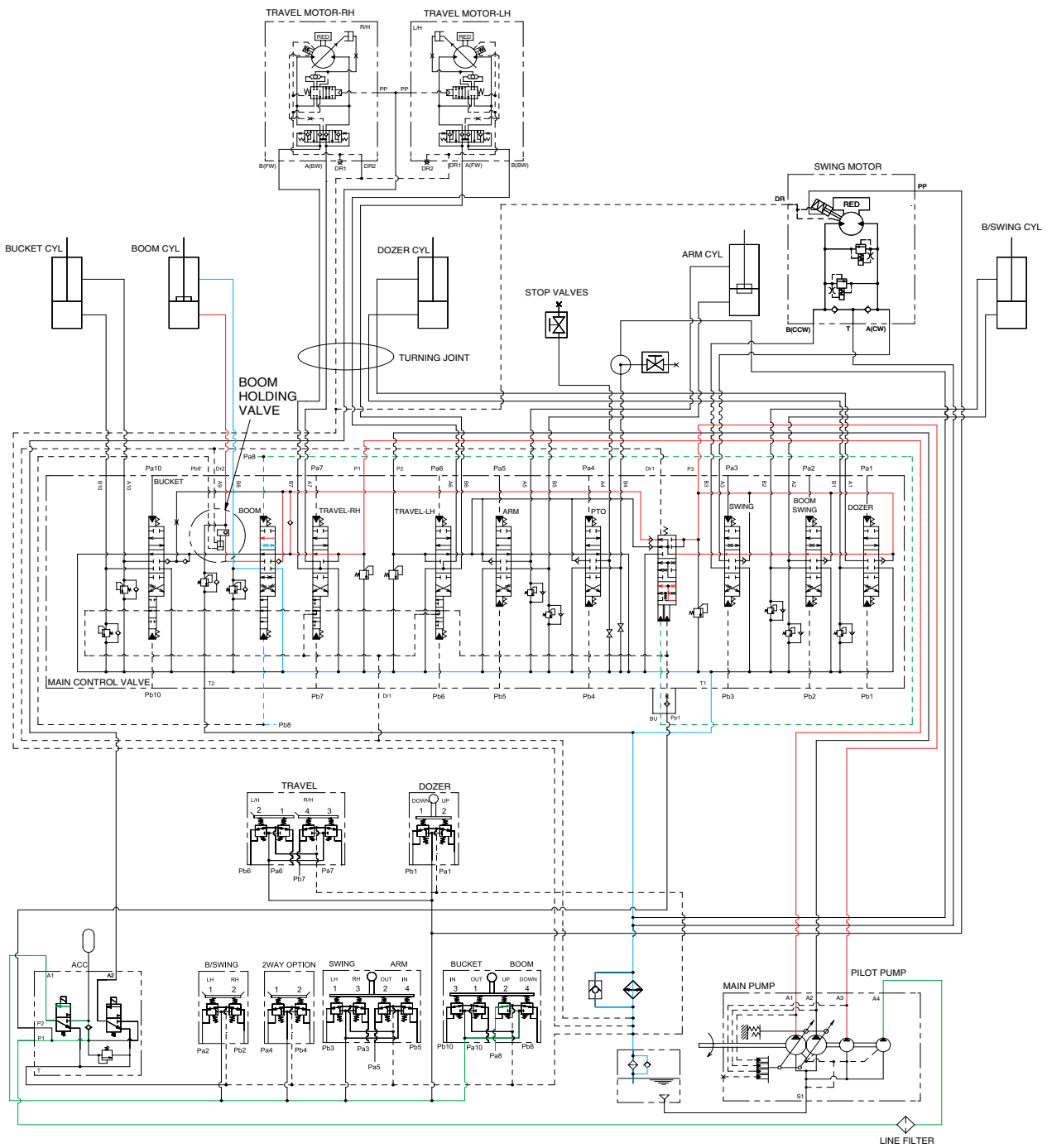

When the right control lever is pulled back, the boom spools in the main control valve are moved to the up position by the pilot oil pressure from the remote control valve.

The oil from the A1 and A3 pump flows into the main control valve and then goes to the large chamber of boom cylinders. At the same time, the oil from the small chamber of boom cylinders returns to the hydraulic oil tank through the boom spool in the main control valve. When this happens, the boom goes up. The excessive pressure in the boom cylinder bottom end circuit is prevented by relief valve. When the boom is up and the control lever is returned to neutral position, the circuit for the holding pressure at the bottom end of the boom cylinder is closed by the boom holding valve. This prevents the hydraulic drift of boom cylinder.

2. BOOM DOWN OPERATION

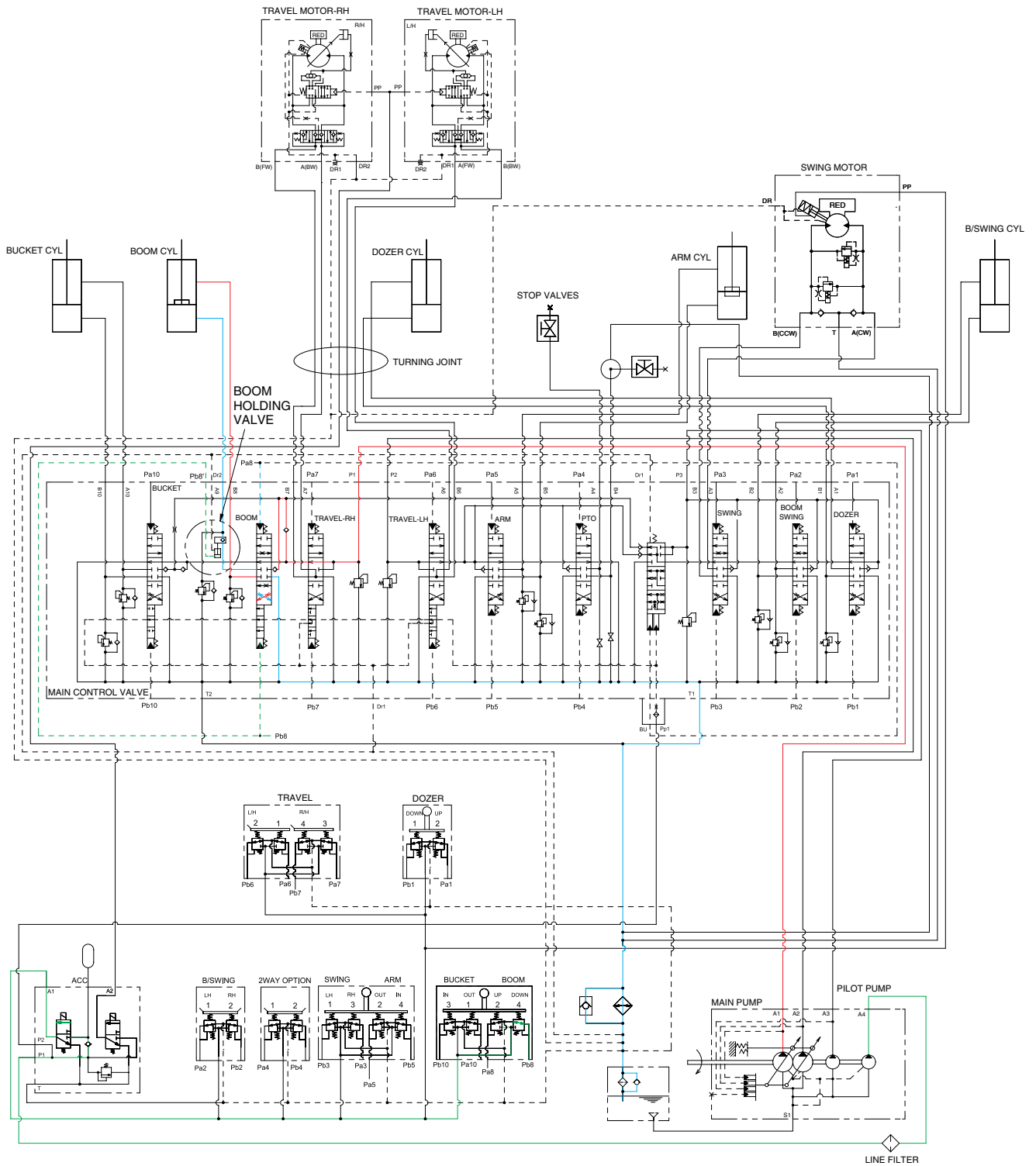

R27Z93HC11

When the right control lever is pushed forward, the boom spools in the main control valve are moved to the down position by the pilot oil pressure from the remote control valve. Since Pb8 port is connected Pb8' port through the piping, boom holding valve is also released.

The oil from the A1 pump flows into the main control valve and then goes to the small chamber of boom cylinders. At the same time, the oil from the large chamber of boom cylinders returns to the hydraulic tank through the boom spool in the main control valve.

The excessive pressure in the boom cylinder rod end circuit is prevented by the relief valve.

3. ARM ROLL IN OPERATION

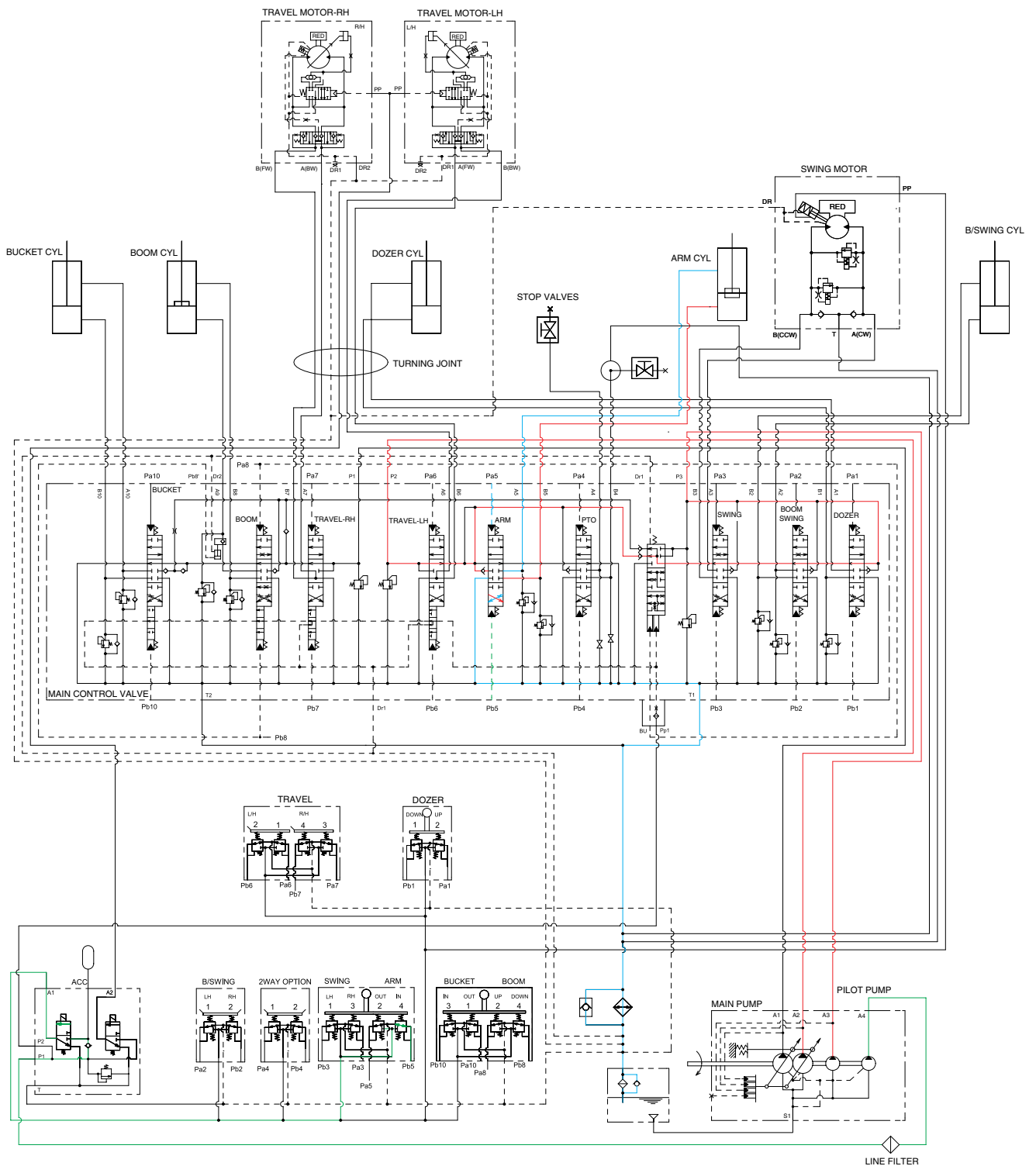

R27Z93HC12

When the left control lever is pulled back, the arm spools in the main control valve are moved to the roll in position by the pilot oil pressure from the remote control valve. The oil from the A2 and A3 pump flows into the main control valve and then goes to the large chamber of arm cylinder. At the same time, the oil from small chamber of arm cylinder returns to the hydraulic oil tank through the arm spool in the main control valve. When this happens, the arm rolls in. The cavitation which will happen to the bottom of the arm cylinder is also prevented by the make-up valve in the main control valve.

4. ARM ROLL OUT OPERATION

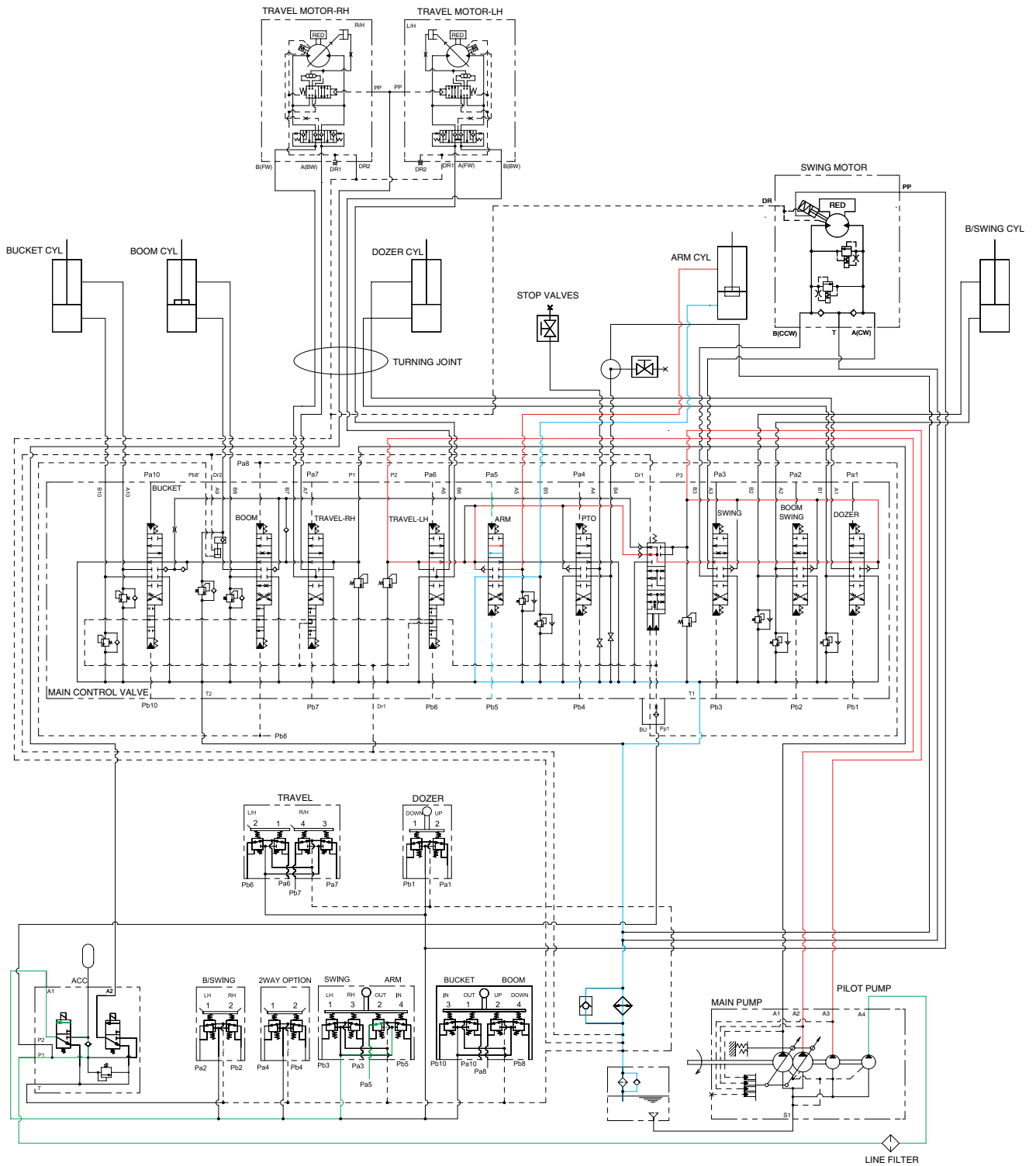

R27Z93HC13

When the left control lever is pushed forward, the arm spool in the main control valve are moved to the roll out position by the pilot oil pressure from the remote control valve.

The oil from the A2 and A3 pump flows into the main control valve and then goes to the small chamber of arm cylinder.

At the same time, the oil from the large chamber of arm cylinder returns to the hydraulic oil tank through the arm spool in the main control valve. When this happens, the arm rolls out.

The cavitation which will happen to the rod of the arm cylinder is also prevented by the make-up valve in the main control valve.

5. BUCKET ROLL IN OPERATION

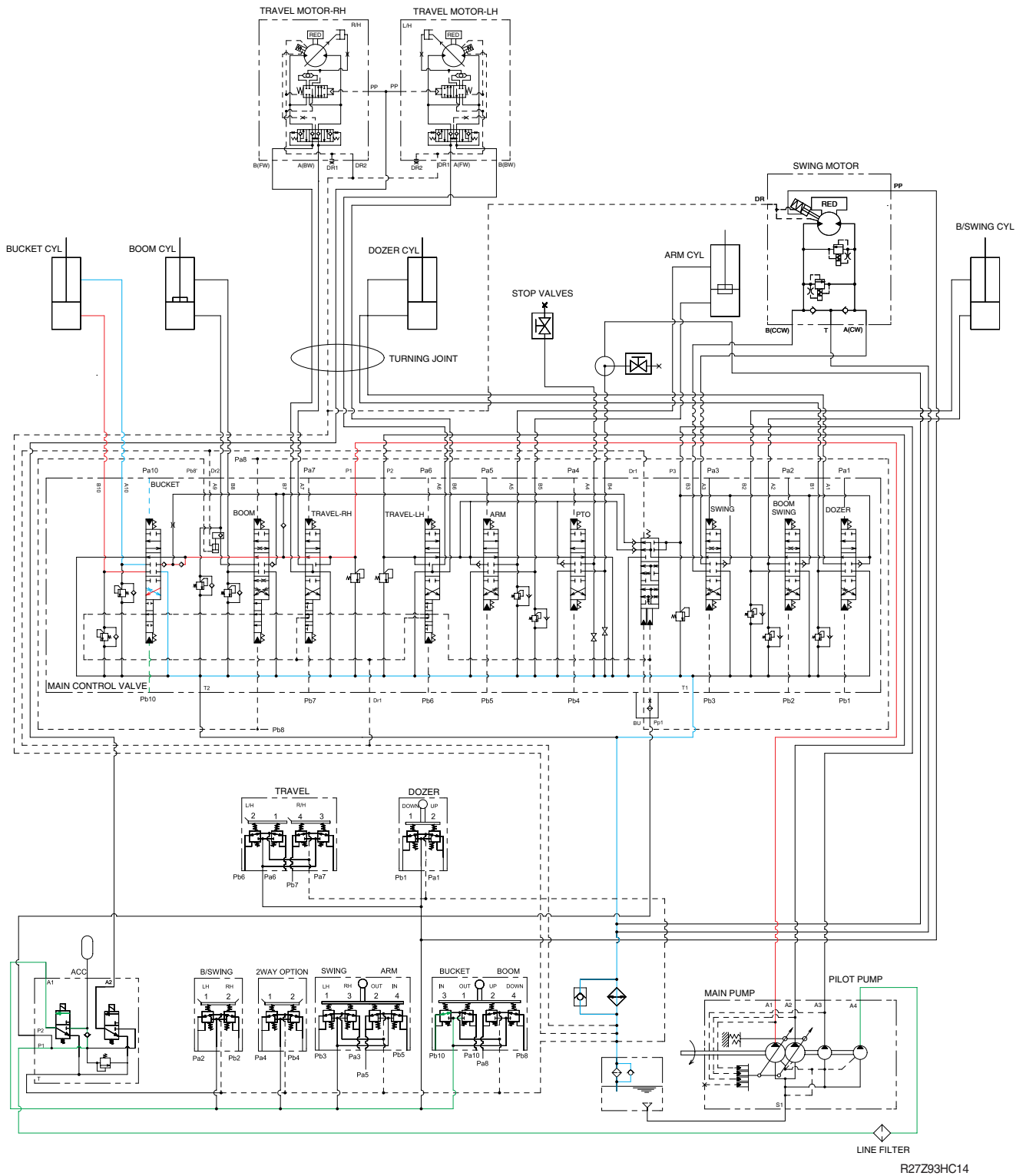

R27Z93HC14

When the right control lever is pulled left, the bucket spool in the main control valve is moved to the roll in position by the pilot oil pressure from the remote control valve.

The oil from the A1 pump flows into the main control valve and then goes to the large chamber of bucket cylinder.

At the same time, the oil from the small chamber of bucket cylinder returns to the hydraulic oil tank through the boom/swing spool in the main control valve. When this happens, the bucket rolls in.

The cavitation which will happen to the bottom of the bucket cylinder is also prevented by the make-up valve in the main control valve.

6. BUCKET ROLL OUT OPERATION

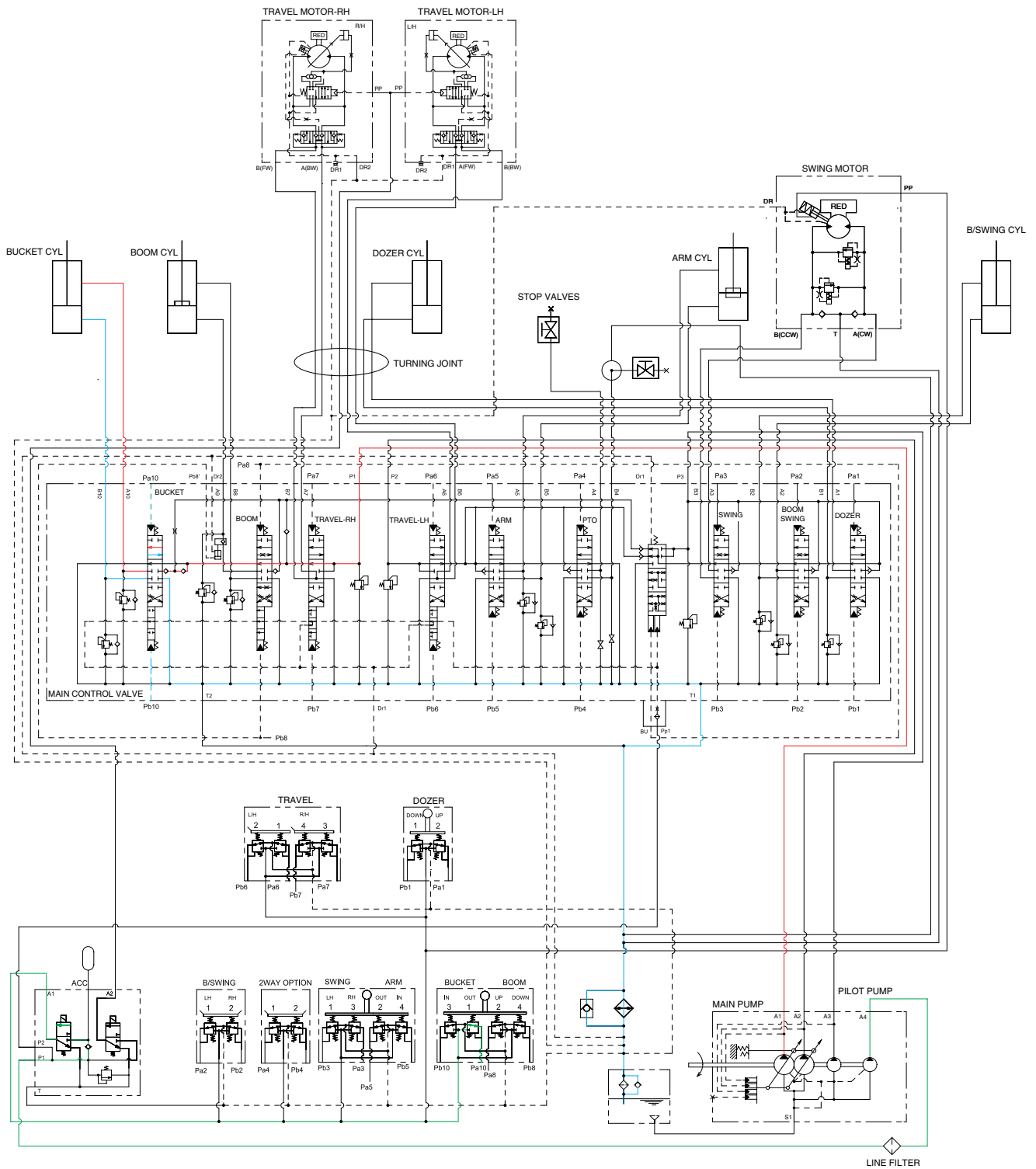

R27Z93HC15

When the right control lever is pushed right, the bucket spool in the main control valve is moved to the roll out position by the pilot oil pressure from the remote control valve.

The oil from the A1 pump flows into the main control valve and then goes to the small chamber of bucket cylinder.

At the same time, the oil from the large chamber of bucket cylinder returns to the hydraulic oil tank through the bucket spool in the main control valve. When this happens, the bucket rolls out.

The cavitation which will happen to the rod of the bucket cylinder is also prevented by the make-up valve in the main control valve.

7. SWING OPERATION

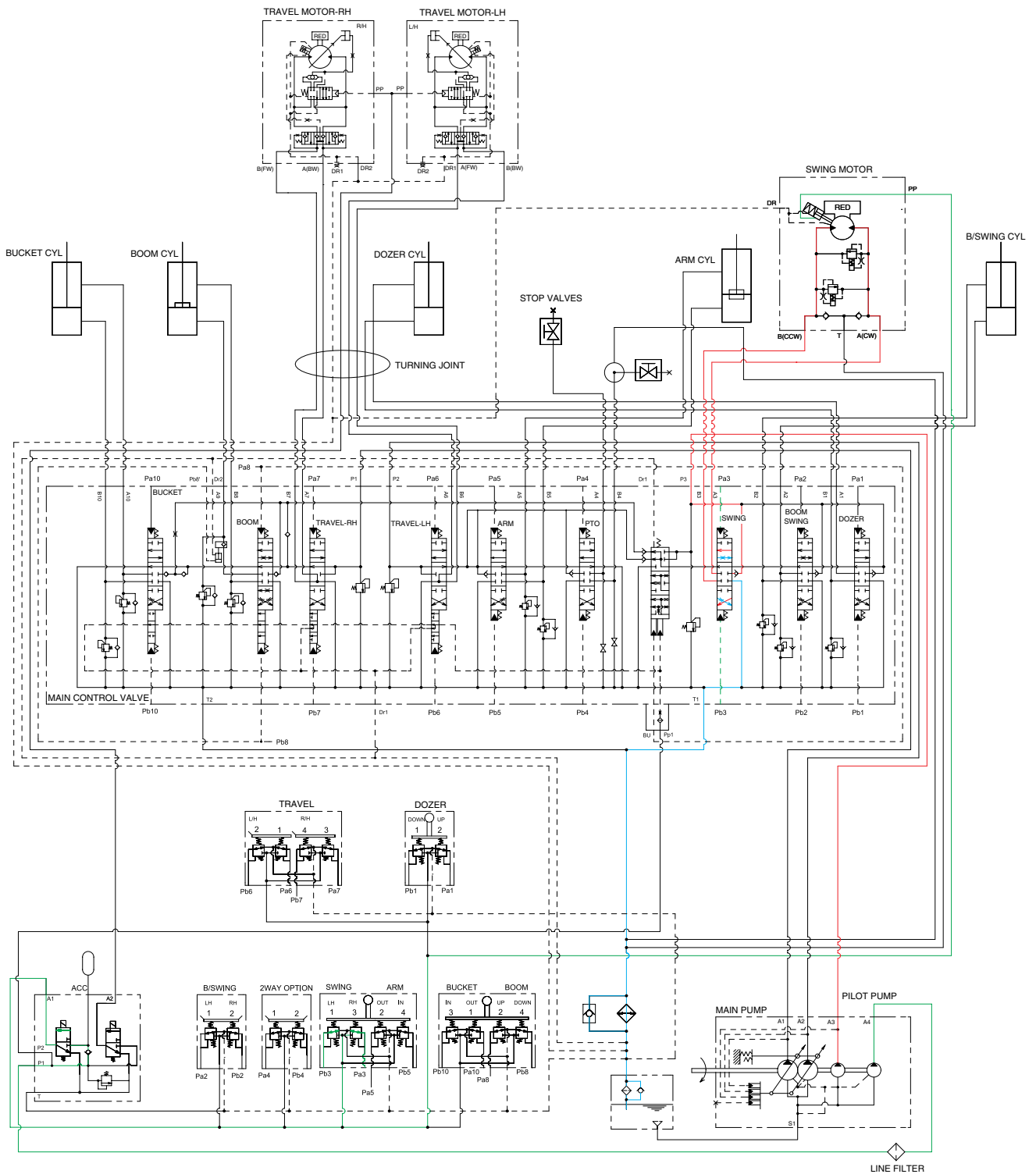

R27Z93HC16

When the left control lever is pushed left or right, the swing spool in the main control valve is moved to the left or right swing position by the pilot oil pressure from the remote control valve.

The oil from the A3 pump flows into the main control valve and then goes to the swing motor.

At the same time, the return oil from the swing motor returns to the hydraulic oil tank through the swing spool in the main control valve. When this happens, the superstructure swings to the left or right. The swing parking brake, make up valve and the overload relief valve are provided in the swing motors. The cavitation which will happen to the swing motor is also prevented by the make up valve in the swing motor itself.

SWING CIRCUIT OPERATION

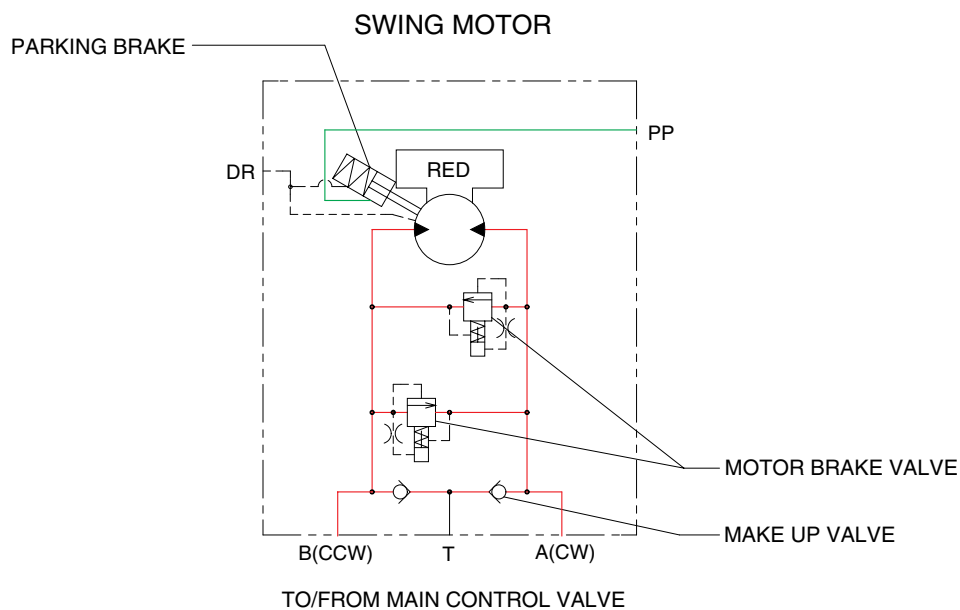

R27Z93HC40

1) MOTOR BRAKE VALVE

Motor brake valve for the swing motor limits to cushion the starting and stopping pressure of swing operation.

2) MAKE UP VALVE

The make up valves prevent cavitation by supplying return oil to the vacuum side of the motor.

3) PARKING BRAKE

PARKING BRAKE "ON" OPERATION

When the safety solenoid lever is moved to upward, the oil in the parking brake is drained to the tank. So, parking brake is applied.

PARKING BRAKE "OFF" OPERATION

The parking brake is released by the pilot pressure oil from pilot pump.

When the safety solenoid lever is moved to downward, the pilot pressure from the A4 pilot pump is flow into parking brake through safety solenoid valve.

Then the pilot pressure lift the brake piston and release the parking brake.

8. TRAVEL FORWARD AND REVERSE OPERATION

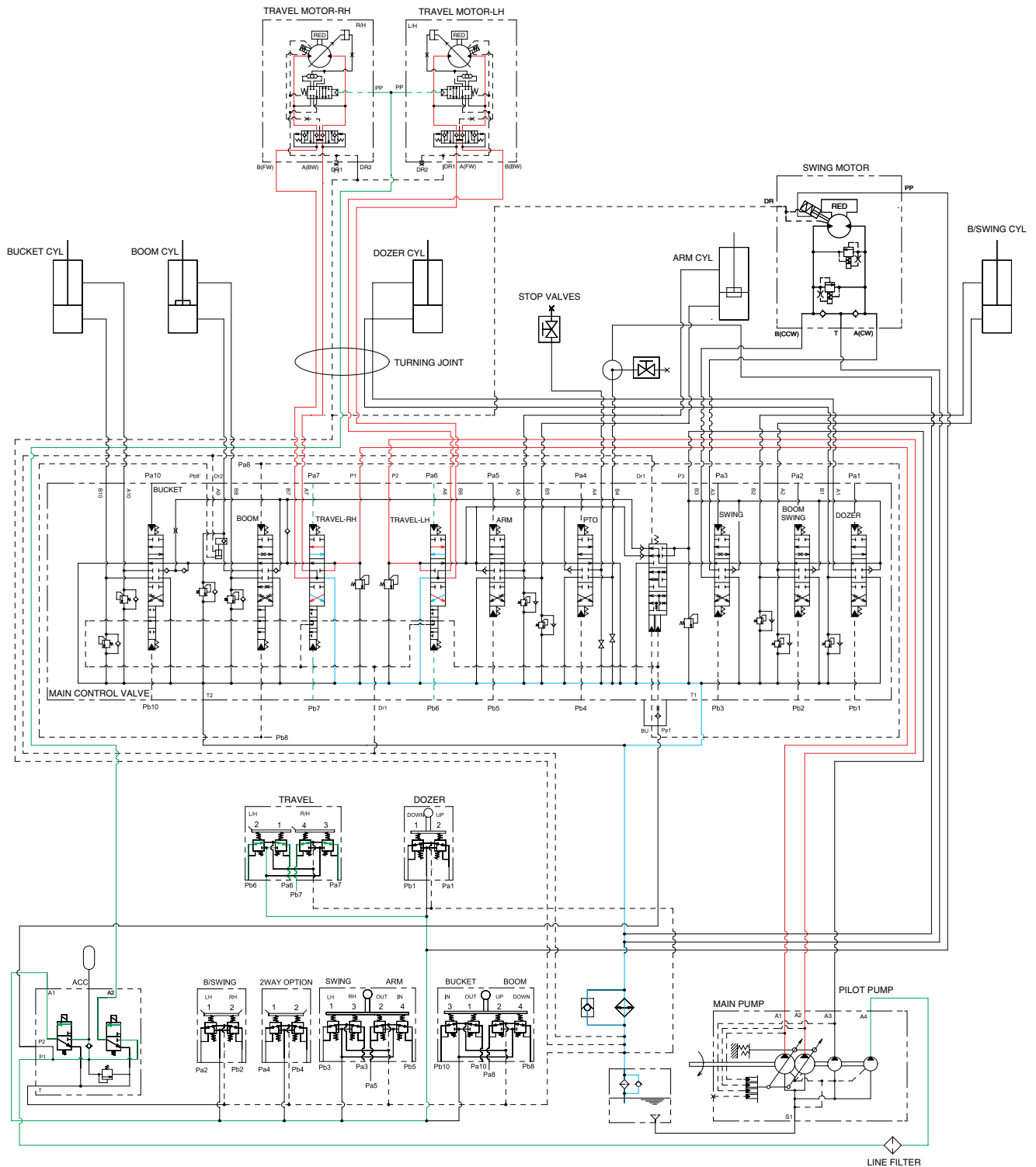

R27Z93HC17

When the travel levers are pushed forward or reverse position, the travel spools in the main control valve are moved to the forward or reverse travel position by pilot pressure oil. The oil from the both pumps flows into the main control valve and then goes to the both travel motors through the turning joint. The return oil from both travel motors returns to the hydraulic oil tank through the turning joint and the travel spools in the main control valve. When this happens, the machine moves to the forward or reverse.

TRAVEL CIRCUIT OPERATION

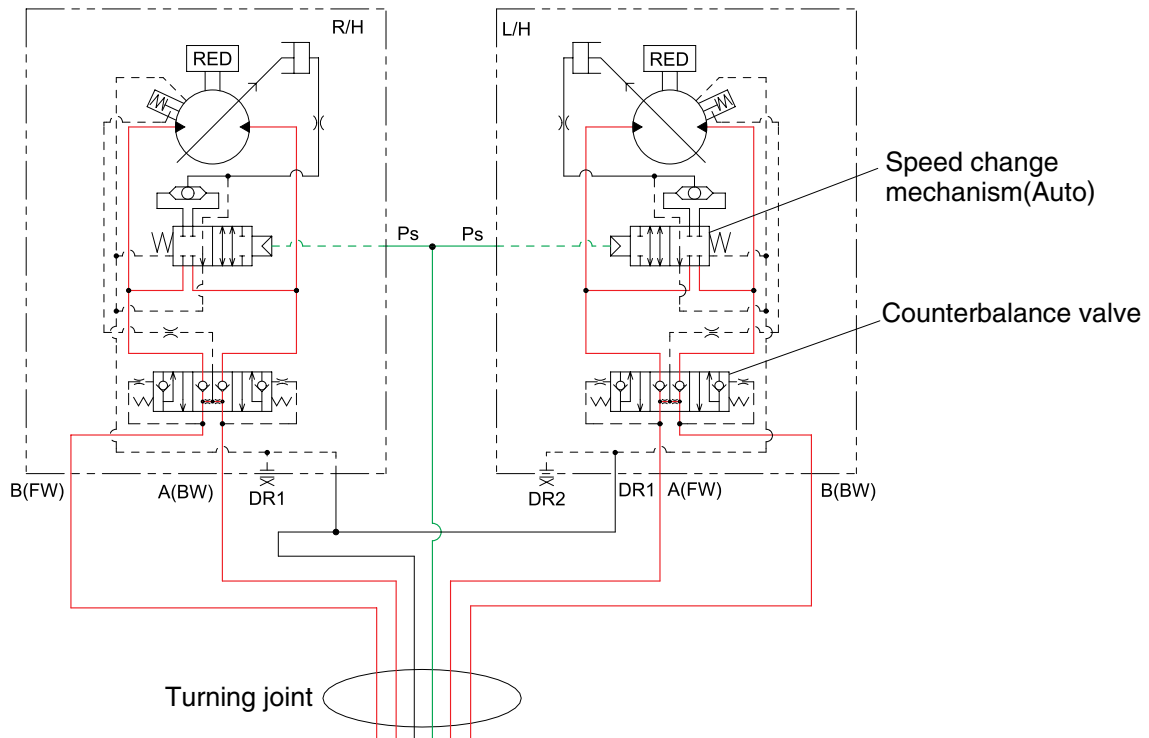

R27Z93HC42

Valves are provided on travel motors to offer the following functions.

1) COUNTERBALANCE VALVE

When stopping the motor of slope descending, this valve to prevent the motor over run.

2) SPEED CHANGE MECHANISM (auto)

Auto two speed control mechanism consists of two spools and spring. This valve automatically changes motor displacement in portion to motor pressure.

9. DOZER UP OPERATION

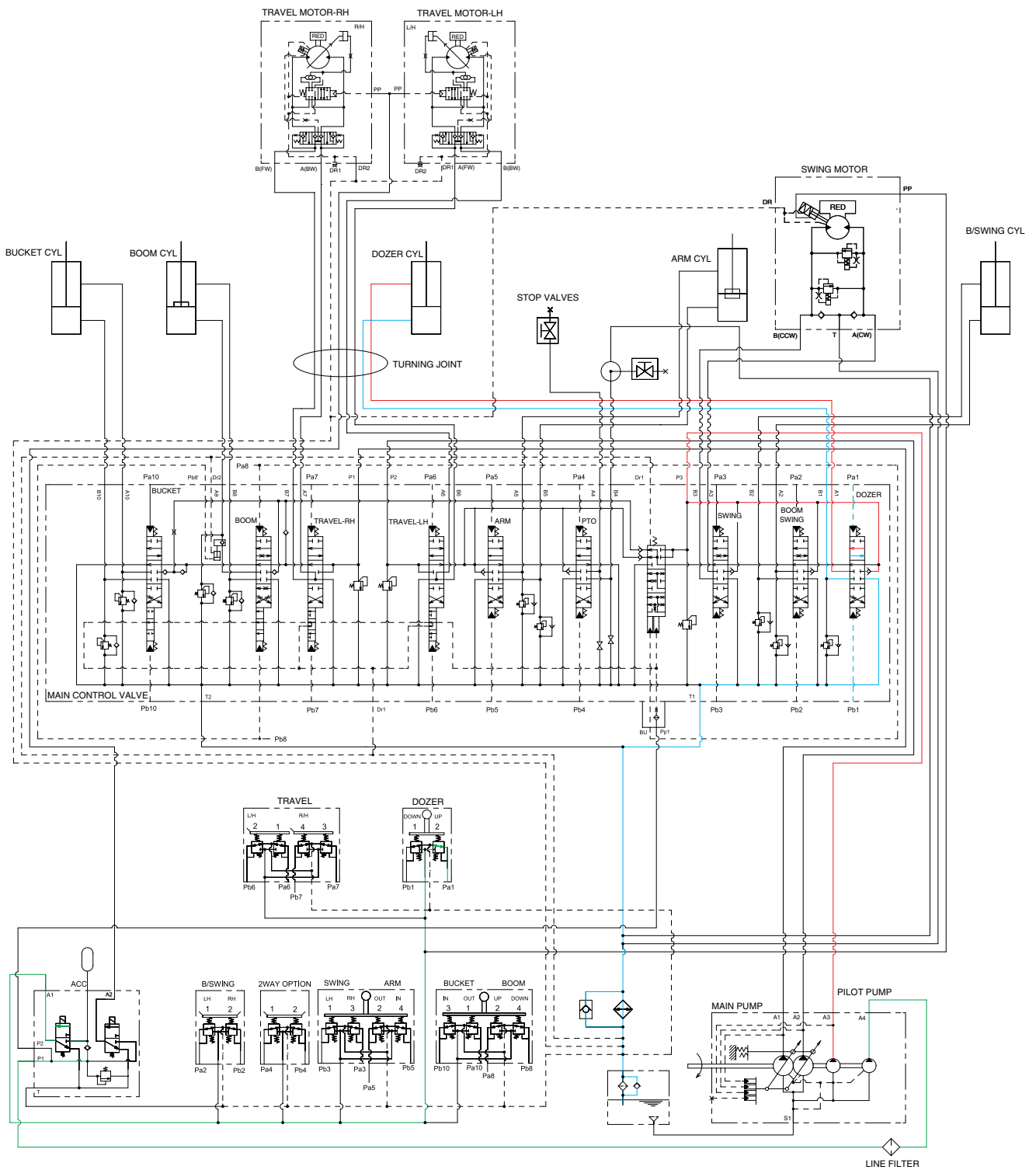

R27Z93HC18

When the dozer control lever is pulled back, the dozer spool in the main control valve is moved to the dozer up position by the pilot oil pressure from the remote control valve.

The oil from the A3 pump flows into the main control valve and then goes to the small chamber of dozer cylinders.

At the same time, the oil from the large chamber of dozer cylinders returns to the hydraulic oil tank through the dozer spool in the main control valve. When this happens, the dozer goes up.

10. DOZER DOWN OPERATION

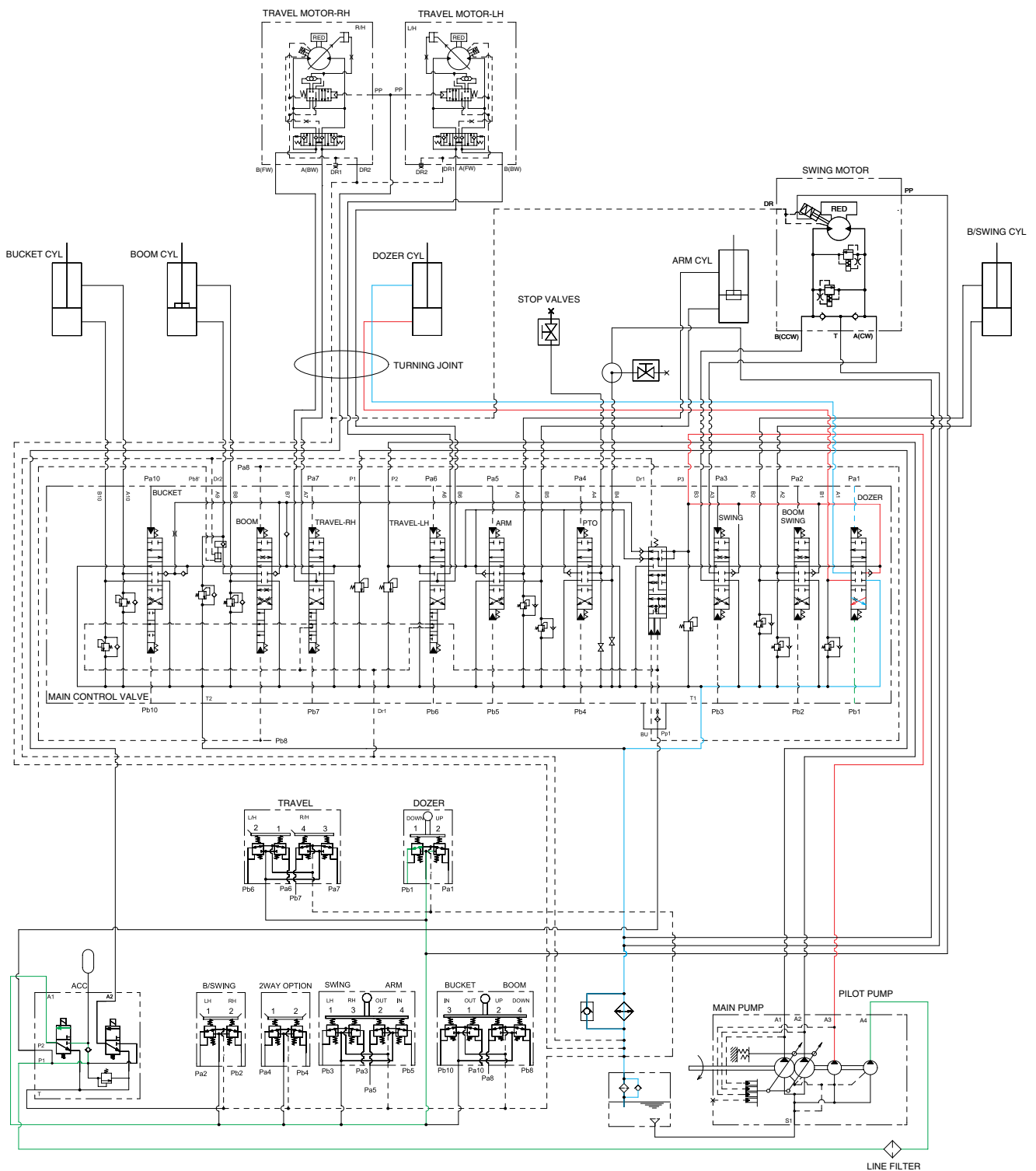

R27Z93HC19

When the dozer control lever is pushed forward, the dozer spool in the main control valve is moved to the dozer down position by the pilot oil pressure from the remote control valve.

The oil from the A3 pump flows into the main control valve and then goes to the large chamber of dozer cylinders.

At the same time, the oil from the small chamber of dozer cylinders returns to the hydraulic oil tank through the dozer spool in the main control valve. When this happens, the dozer blade is down.

GROUP 5 COMBINED OPERATION

1. OUTLINE

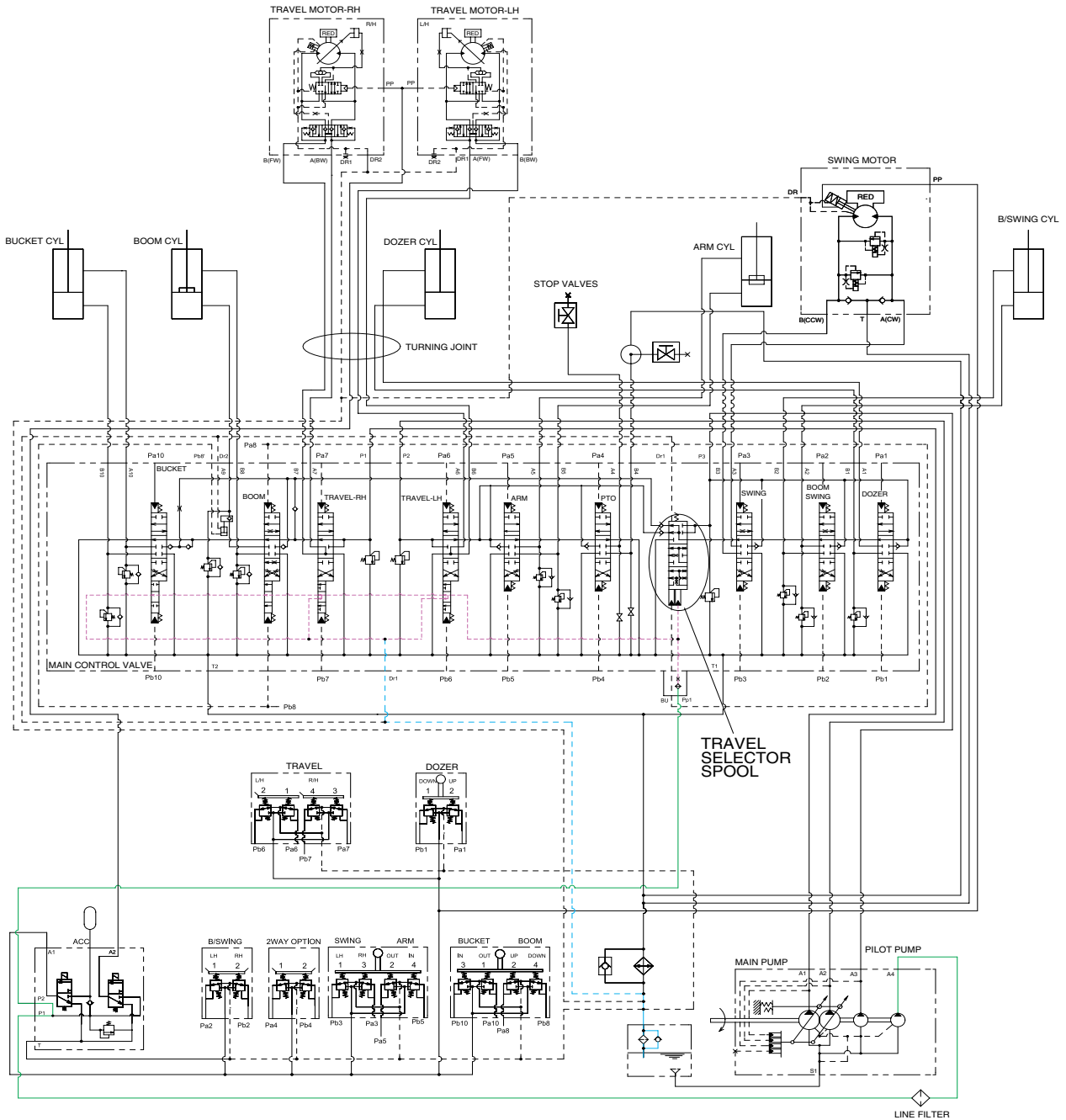

R27Z93HC30

The oil from the A1, A2, A3 pump flows through the neutral oil passage, bypass oil passage and confluence oil passage in the main control valve. Then the oil goes to each actuator and operates them. Check valves and orifices are located on these oil passage in the main control valve. These control the oil from the main pumps so as to correspond to the operation of each actuator and smooth the combined operation.

INDEPENDENT TRAVEL SYSTEM

This independent travel system for straight travel is provided in the main control valve.

If any actuator(s) on A1 and A2 pump side is operated when traveling, the travel selector spool is moved to the selected side by the pilot oil pressure.

Consequently, the pressure oil from A1 and A2 pump are supplied to the right and left travel motor and oil from A3 pump flows into the other operated actuator.

This keeps the straight travel.

2. COMBINED SWING AND BOOM OPERATION

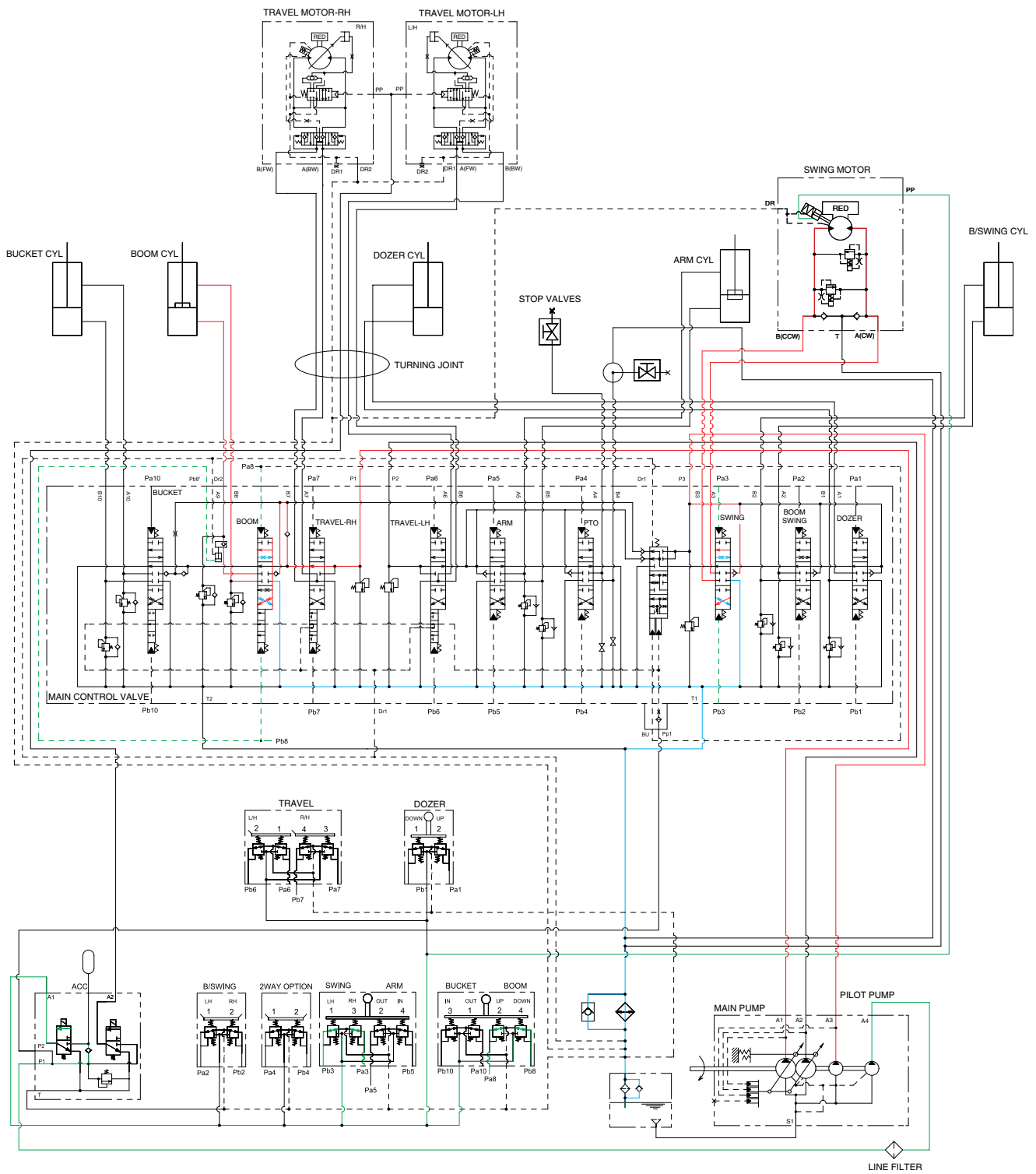

R27Z93HC31

When the swing and boom functions are operated, simultaneously the swing spool and boom spools in the main control valve are moved to the functional position by the pilot oil pressure from the remote control valve.

The oil from the A1 pump flows into the boom cylinder through boom.

The oil from the A3 pump flows into the swing motor through the swing spool.

The superstructure swings and the boom is operated.

3. COMBINED SWING AND ARM OPERATION

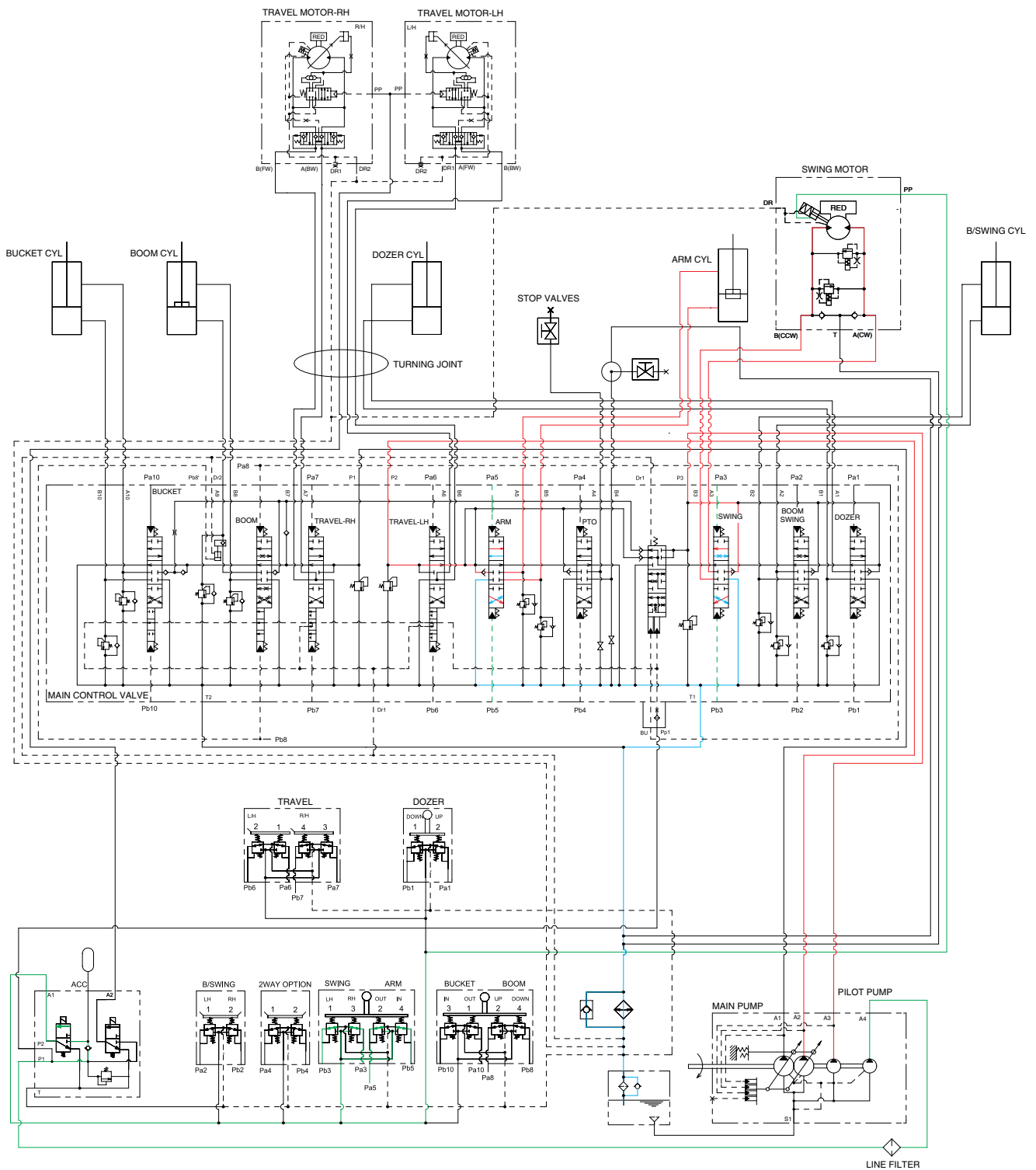

R27Z93HC32

When the swing and arm functions are operated, simultaneously the swing spool and arm spools in the main control valve are moved to the functional position by the pilot oil pressure from the remote control valve.

The oil from the A3 pump flows into the swing motor through swing spool.

The oil from the A2 pump flows into the arm cylinder through the arm.

The superstructure swings and the arm is operated.

4. COMBINED SWING AND BUCKET OPERATION

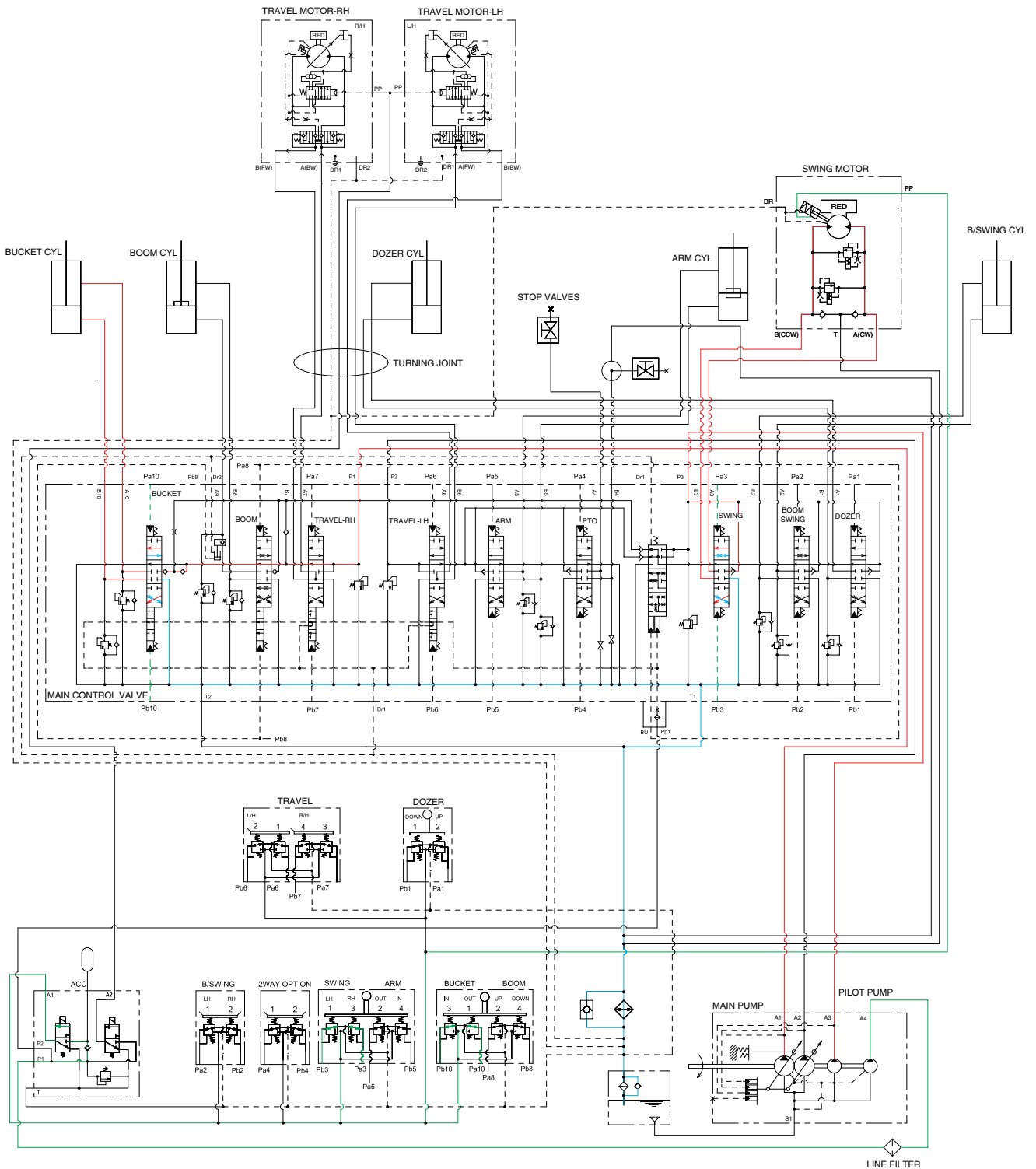

R27Z93HC33

When the swing and bucket functions are operated, simultaneously the swing spool and bucket spool in the main control valve are moved to the functional position by the pilot oil pressure from the remote control valve.

The oil from the A3 pump flows into the swing motor through the swing spool.

The oil from the A1 pump flows into the bucket cylinder through the bucket spool.

5. COMBINED SWING, BOOM, ARM AND BUCKET OPERATION

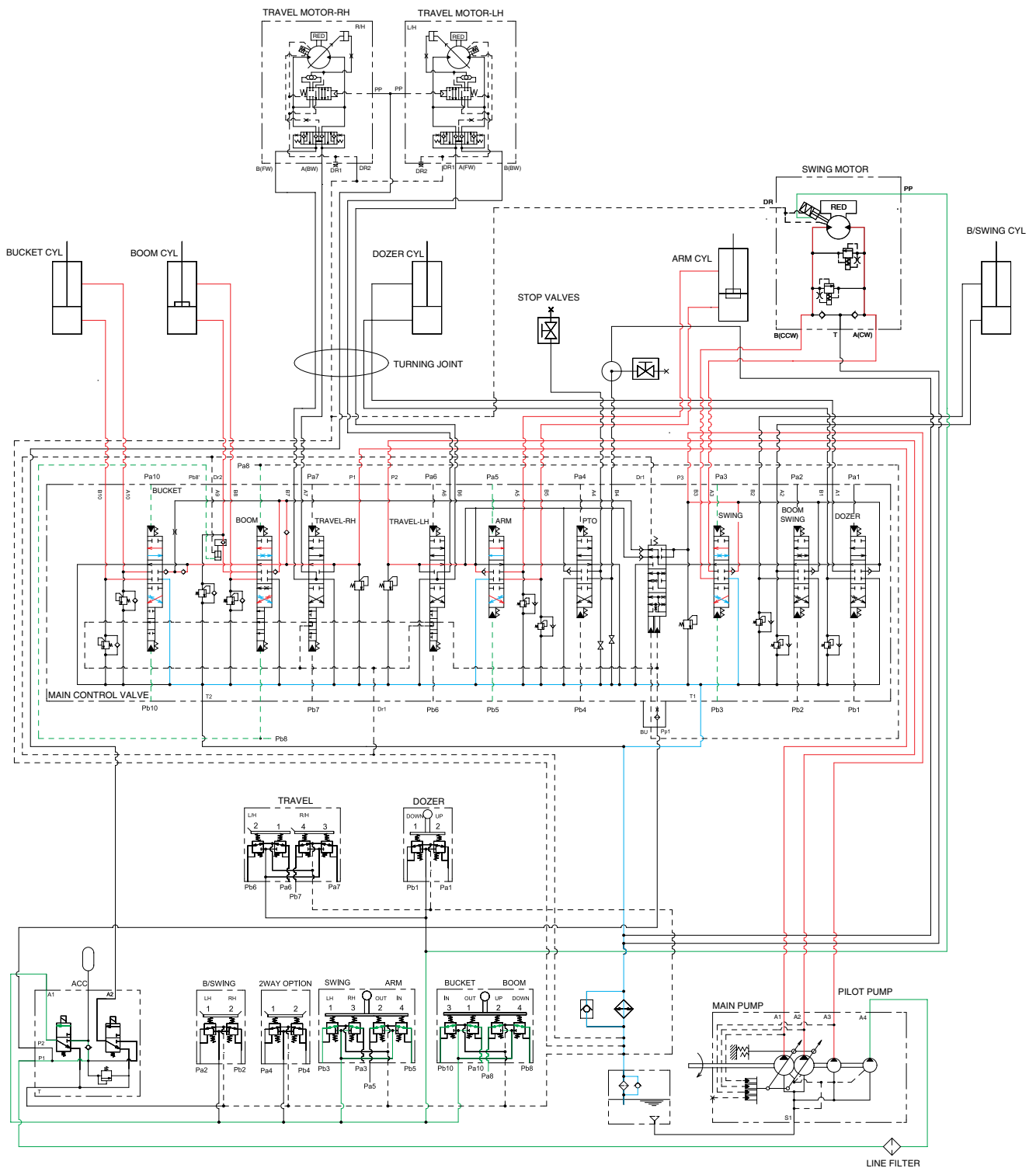

R27Z93HC34

When the swing, boom, arm and bucket functions are operated, simultaneously each spool in the main control valve is moved to the functional position by the pilot oil pressure from the remote control valve.

The oil from the A2 pump flows into the arm cylinder through, arm spool.

The oil from the A1 pump flows into the boom cylinders and bucket cylinder through the boom spool, bucket spool.

The oil from the A3 pump flows into the swing motor through the swing spool.

The superstructure swings and the boom, arm and bucket are operated.

6. COMBINED SWING AND TRAVEL OPERATION

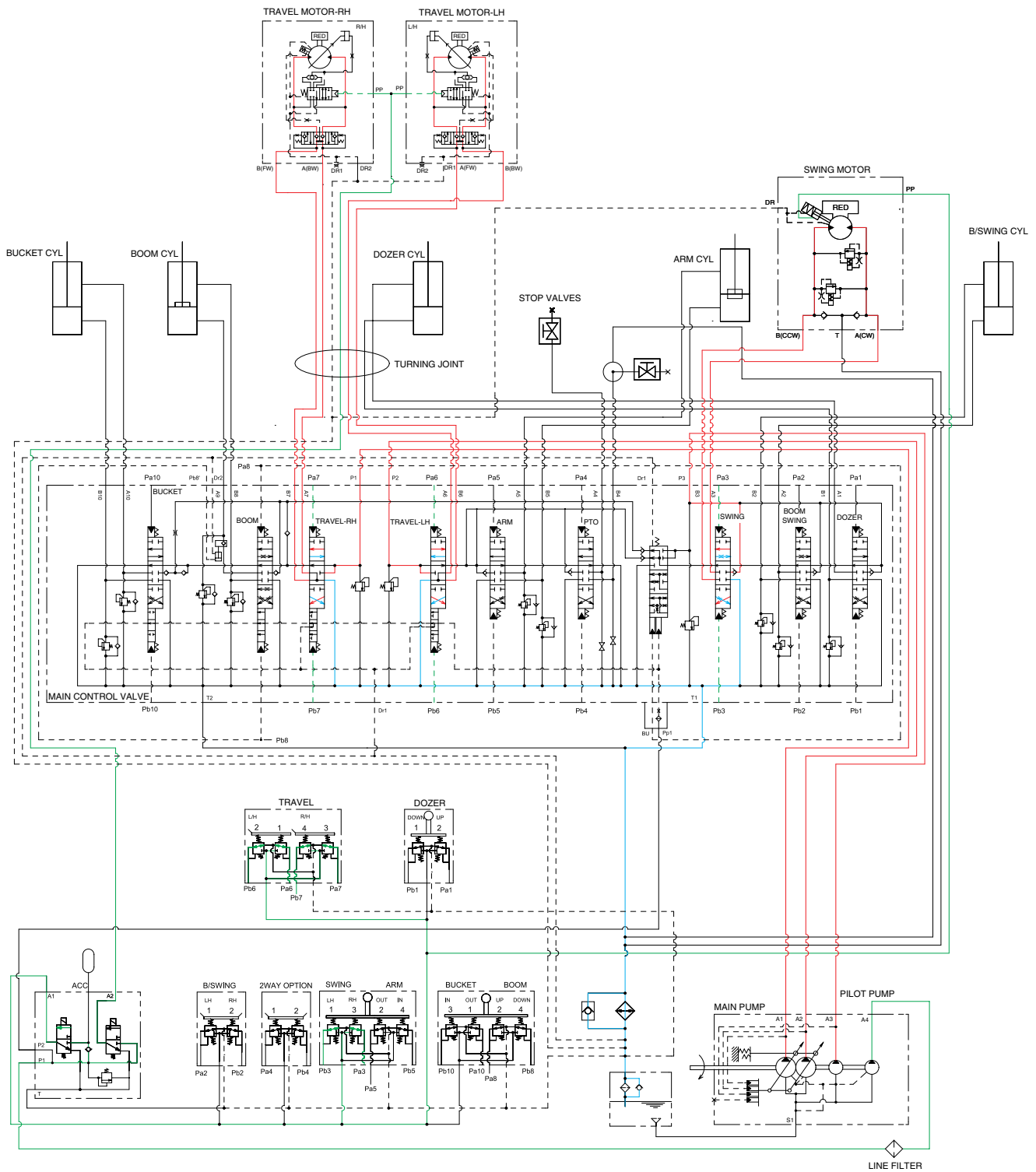

R27Z93HC35

When the swing and travel functions are operated, simultaneously the swing spool and travel spools in the main control valve are moved to the functional position by the pilot oil pressure from the remote control valve and the travel levers.

The oil from the A3 pump flows into the swing motor through the swing spool.

The oil from the A1 pump flows into the travel motor through the RH travel spool.

The oil from the A2 pump flows into the travel motor through the LH travel spool.

The superstructure swings and the machine travels straight.

7. COMBINED BOOM AND TRAVEL OPERATION

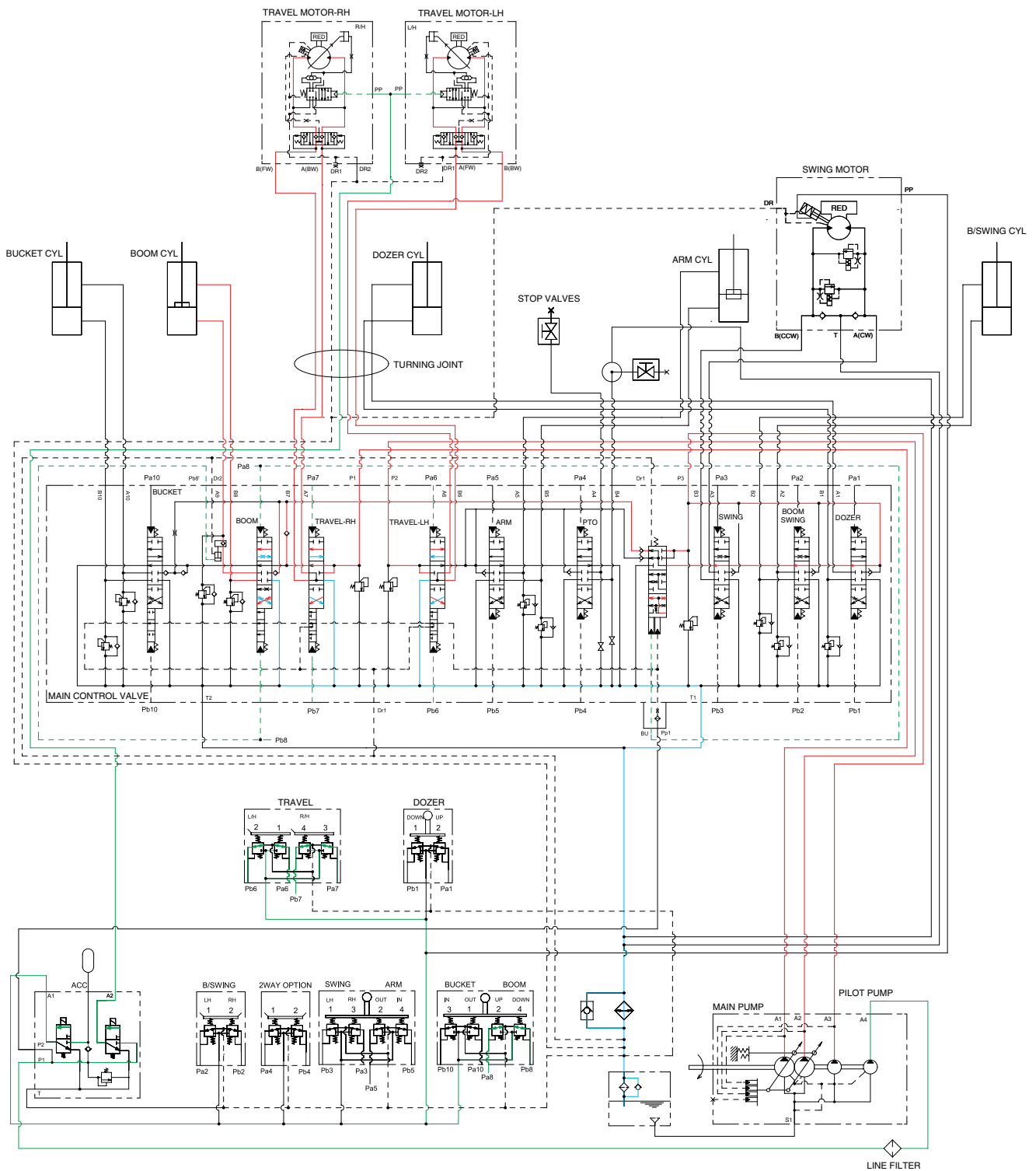

R27Z93HC36

When the boom and travel functions are operated, simultaneously the boom spools and travel spools in the main control valve are moved to the functional position by the pilot oil pressure from the remote control valve.

The oil from the A1 and A2 pumps flows into the travel motors through travel RH and travel LH spools.

The oil from the A3 pump flows into the boom cylinders through boom spool via the travel selector spool. The boom is operated and the machine travels straight.

8. COMBINED ARM AND TRAVEL OPERATION

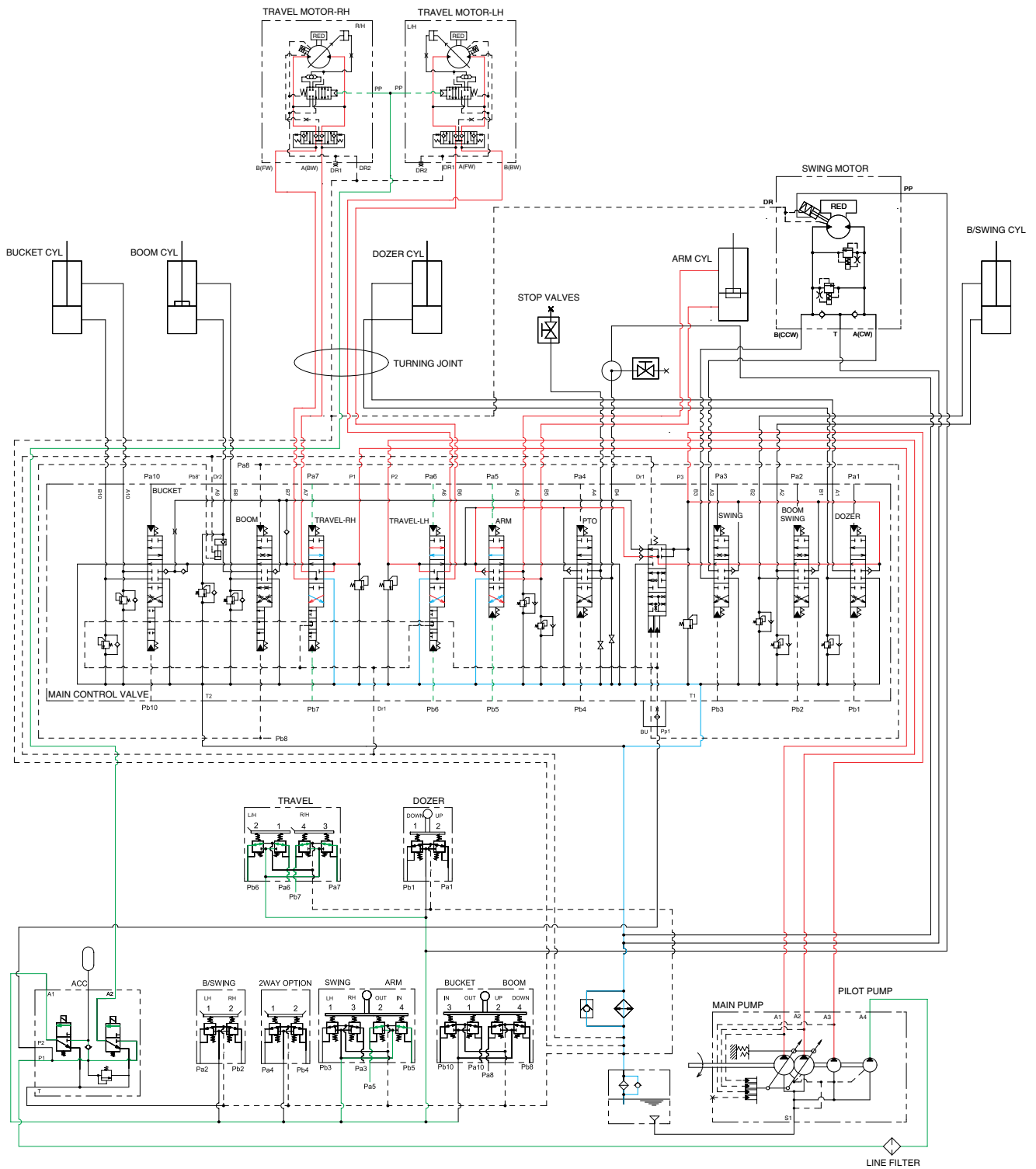

R27Z93HC37

When the arm and travel functions are operated, simultaneously the arm spools and travel spools in the main control valve are moved to the functional position by the pilot oil pressure from the remote control valve.

The oil from the A1 and A2 pumps flows into the travel motors through travel spools.

The oil from the A3 pump flows into the arm cylinder through arm spool via the travel selector spool.

The arm is operated and the machine travels straight.

9. COMBINED BUCKET AND TRAVEL OPERATION

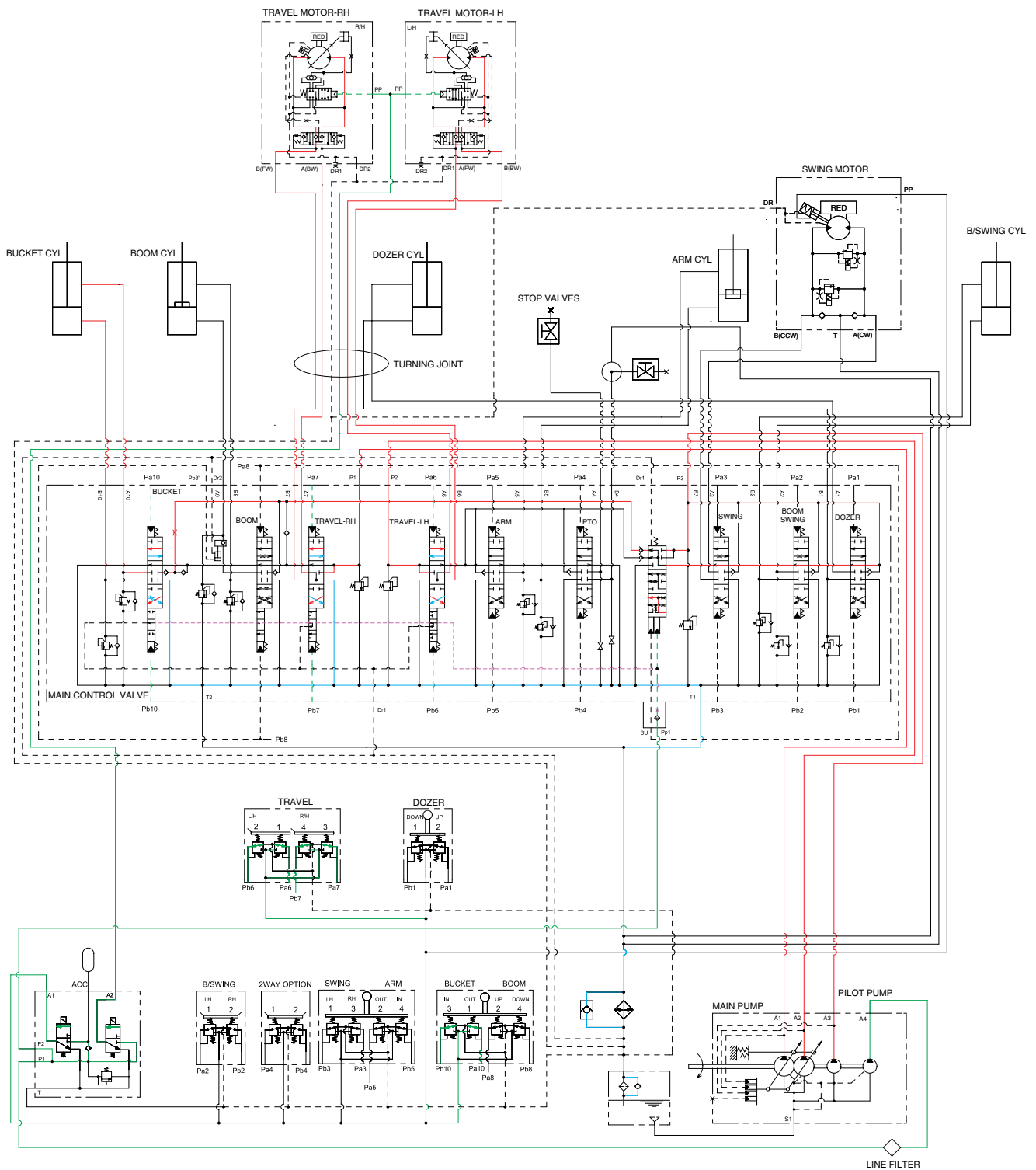

R27Z93HC38

When the bucket and travel functions are operated, simultaneously the bucket spool and travel spools in the main control valve are moved to the functional position by the pilot oil pressure from the remote control valve, and the travel selector spool is pushed to the up by the oil pressure from pilot pump. The oil from the A1 and A2 pumps flows into the travel motors.

The oil from the A3 pump flows into the bucket cylinder through bucket spool via the travel selector spool.

The bucket is operated and the machine travels straight.