

GROUP 6 TRAVEL DEVICE (TYPE 1)

1. REMOVAL AND INSTALL

1) REMOVAL

- (1) Swing the work equipment 90° and lower it completely to the ground.
- (2) Operate the control levers and pedals several times to release the remaining pressure in the hydraulic piping.
- (3) Loosen the breather slowly to release the pressure inside the hydraulic tank.

▲ Escaping fluid under pressure can penetrate the skin causing serious injury.

※ When pipes and hoses are disconnected, the oil inside the piping will flow out, so catch it in oil pan.

- (4) Remove the track shoe assembly.
For details, see **removal of track shoe assembly**.
- (5) Remove the cover.
- (6) Remove the hose.
※ Fit blind plugs to the disconnected hoses.
- (7) Remove the bolts and the sprocket.
- (8) Sling travel device assembly (1).
- (9) Remove the mounting bolts (2), then remove the travel device assembly.
· Weight : 276 kg (608 lb)

2) INSTALL

- (1) Carry out installation in the reverse order to removal.
- (2) Bleed the air from the travel motor.
 - ① Remove the air vent plug.
 - ② Pour in hydraulic oil until it overflows from the port.
 - ③ Tighten plug lightly.
 - ④ Start the engine, run at low idling, and check oil come out from plug.
 - ⑤ Tighten plug fully.
- (3) Confirm the hydraulic oil level and check the hydraulic oil leak or not.

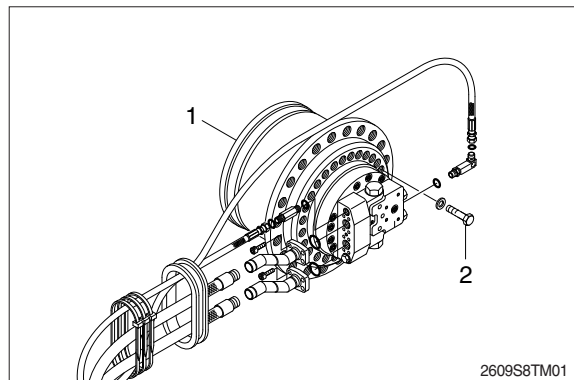

2. SPECIFICATION

1) TRAVEL MOTOR

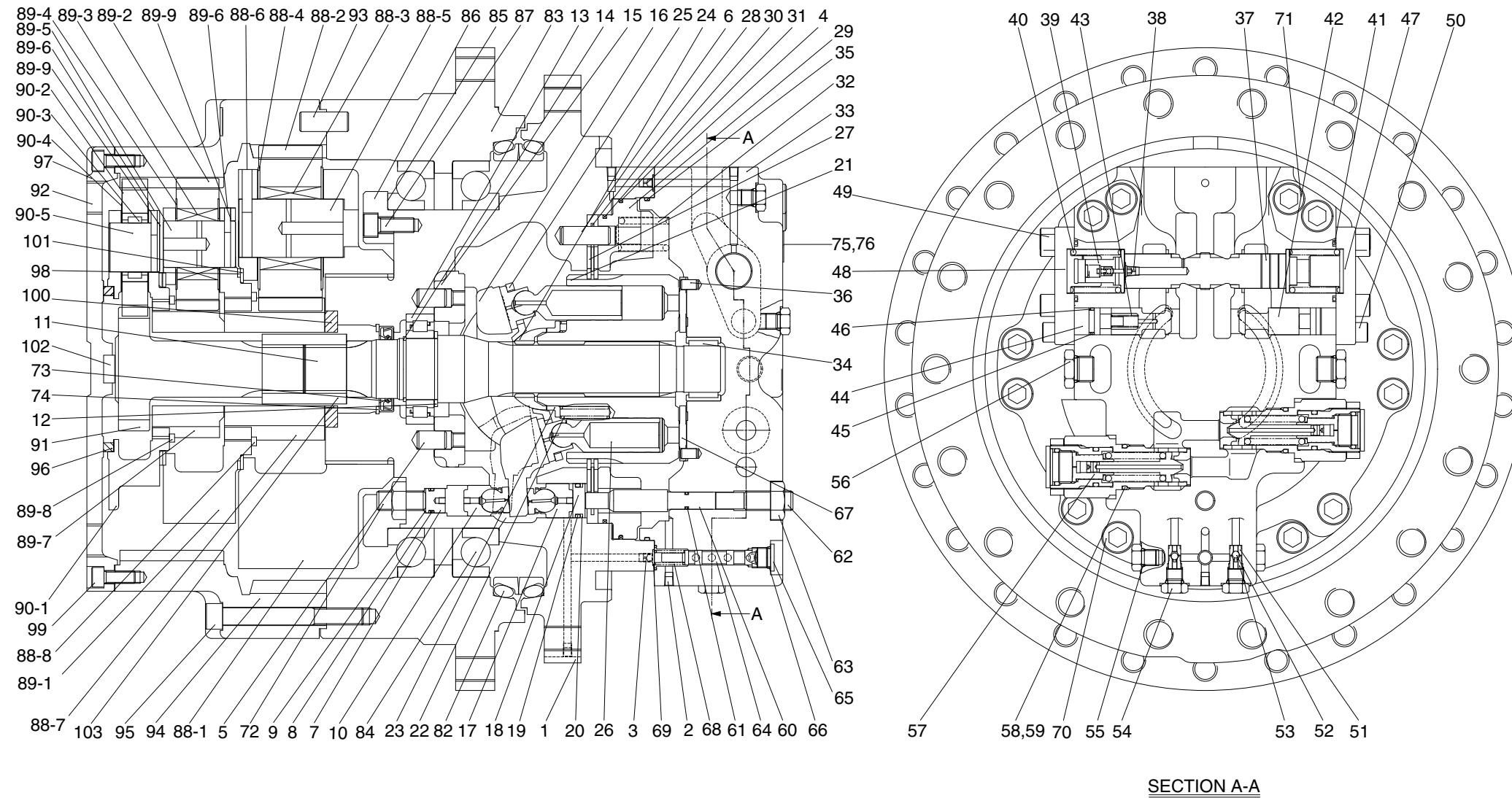

29092TM30

1 Casing	16 Plate	31 Ring	46 Back up ring	61 O-ring	83 Housing	89-1 Carrier No.2	91 Sun gear No.1
2 Plug	17 Piston	32 Spring	47 Cap	62 Lock screw	84 Bearing	89-2 Planetary gear No.2	92 Plug
3 Screw	18 Stopper	33 Valve casing	48 Cap	63 Nut	85 Shim	89-3 Needle No.2	93 Lock pin
4 Screw	19 O-ring	34 Needle bearing	49 Bolt	64 Spool	86 Retainer	89-4 Thrust washer No.2	94 Ring gear
5 Pin	20 Back up ring	35 O-ring	50 Socket bolt	65 Plug	87 Bolt	89-5 Pin No.2	95 Bolt
6 Pin	21 Cylinder block	36 Pin	51 Seat	66 O-ring	88 Carrier No.3	89-6 Spring pin No.2	96 Thrust ring No.1
7 Stopper	22 Cylinder spring	37 Spool	52 Steel ball	67 Valve plate	88-1 Carrier No.3	89-7 Sun gear No.2	97 Cover
8 O-ring	23 Spacer	38 Screw	53 Stopper	68 Spring	88-2 Planetary gear No.3	89-8 Snap ring No.2	98 Thrust ring No.2
9 Back up ring	24 Guide	39 Damping check	54 Plug	69 O-ring	88-3 Needle No.3	89-9 Spring pin No.2	99 Bolt
10 Piston	25 Plate	40 Spring	55 O-ring	70 Socket bolt	88-4 Thrust washer No.3	90 Carrier No.1	100 Motor ring
11 Shaft	26 Piston & Shoe assy	41 O-ring	56 Plug	71 Socket bolt	88-5 Pin No.3	90-1 Carrier No.1	101 Thrust ring No.3
12 Spacer	27 Plate	42 Plunger	57 Relief valve	72 Lock screw	88-6 Spring pin No.3	90-2 Planetary gear No.1	102 Pad
13 Roller bearing	28 Plate	43 Spring	58 O-ring	73 Oil seal	88-7 Sun gear No.3	90-3 Needle bearing No.1	103 Coupling
14 Stop ring	29 Brake	44 Stopper	59 Back up ring	74 Lock ring	88-8 Snap ring No.3	90-4 Thrust washer No.1	
15 Support	30 Ring	45 O-ring	60 Rod	82 Floating Seal	89 Carrier No.2	90-5 Pin No.1	

2) TOOLS

(1) Standard tools

No.	Name	Description/Size	Qty
1	Hexagon wrench (JIS B 4648)	6 (M8) (PT1/4), 8 (M10)	each 1
		10 (M12) (PF1/2)	each 1
		14 (M16), 4 (M6)	1
2	Socket wrench	-	1
3	Torque wrench	Nominal 30 kgf · m dial type	1
		Nominal 90 kgf · m dial type	1
4	Adapter for torque wrench	Socket 22, 30, 32, 41, 40	each 1
		Bar 5, 6, 8, 10, 14	each 1
5	Extension bar (JIS B 4637)	150 mm	1
6	Hammer	12	1
7	Plastic hammer	L=300	1
8	(-) driver	150 mm	1
9	Snap ring plier	For shaft, For hole	1
10	Hanger	Weight : over 300 kgf	1
		Eye bolt (M16)	2
		Eye bolt (M10)	2
		Eye bolt (PF 1/2)	2
		Wire	1
11	Press	Press capacity above 200 kgf	1
12	Compressed air	3~5 kgf/cm ² , nozzle	1
13	Vessel	General vessel : W450 × D300 × H120	2
14	Heating vessel	Heating capacity : over 100 °C	1
		Volume : 500 × 500 × 500	
15	Depth micro-meter	Measuring range : 0.04 ~ 0.3 mm	1
16	Air hammer	BRH-8 (compressed air 5~6 kgf/cm ²)	1
17	Sealant	Silicone rubber (780-RTV)	1

(2) Special tools

① Inversion working bench

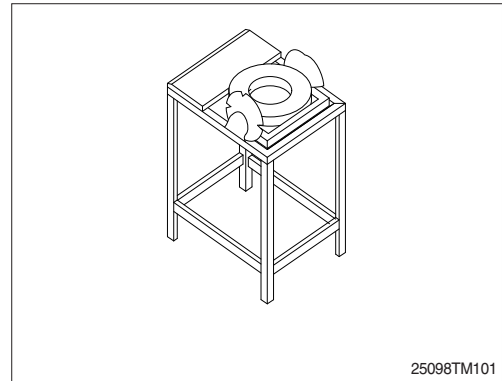

② Retainer (II)

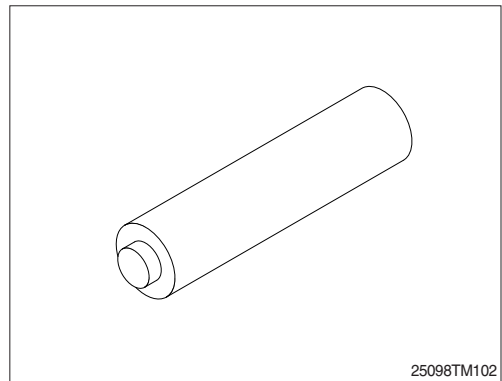

③ Steel bar

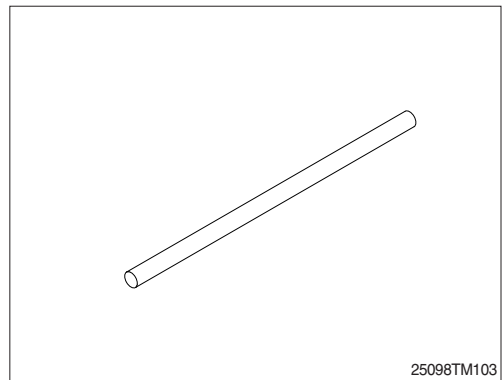

④ Pressurize jig

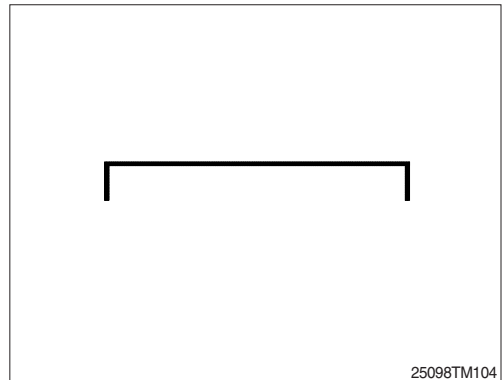

⑤ Floating sealing

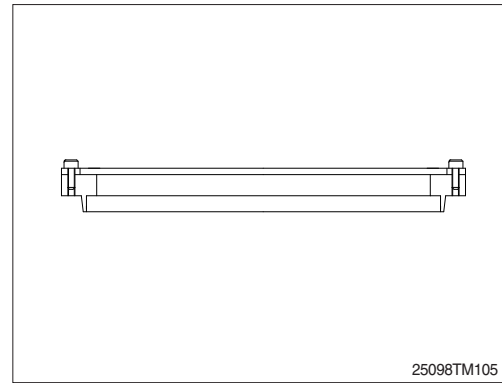

⑥ Caulking jig

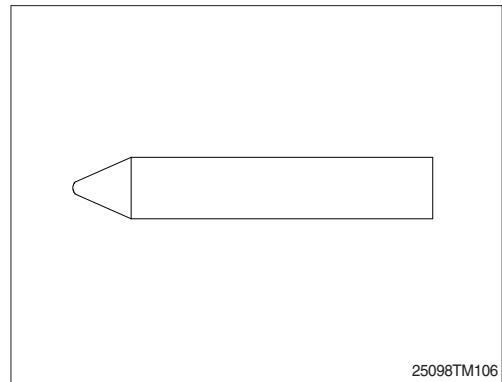

3) TIGHTENING TORQUE

Item No.	Parts name	Size	Qty	Tightening torque	
				kgf · m	lbf · ft
24	Plug	M36×1.5	2	45 ± 9	325 ± 65.1
26	Plug	M26×1.5	2	26 ± 4	188 ± 28.9
43	Socket bolt	M16×2.0	12	25.7 ± 4	186 ± 28.9
52	Plug	PF 1/4	2	3.0 ± 0.5	21.7 ± 3.6
54	Plug	NPTF 1/16	7	1.0 ± 0.25	7.2 ± 1.8
55	Plug	PT 1/4	2	3.0 ± 0.5	21.7 ± 3.6
63,128	Plug	PF 1/2	7	10 ± 2	72.3 ± 14.5
124	Socket bolt	M10×1.5	16	5.9 ± 1	42.7 ± 7.2
412	Adjust plug	M8	2	12 ± 1.5	86.8 ± 10.8

3. DISASSEMBLY

3.1 GENERAL PRECAUTIONS

- 1) Spread rubber or vinyl cover on the work bench.
- 2) When disassembling the travel motor, provide a match mark on the mating face of each part.
- 3) Arrange the detached parts to prevent them from being damaged or lost.
- 4) The disassembled seals must be replaced with new ones as a rule even if they are free from damage. For disassembly, therefore, prepare new seals in advance.

3.2 DISASSEMBLY PROCEDURE

- 1) When inspecting or repairing the travel motors, use the disassembling procedures described below.
- 2) Numerals in brackets () following the part name denote the item numbers used in the structure drawing at page 8-84.
- 3) Prior to disassembly, install the travel motor on an inversion working bench.

3.3 DISASSEMBLING ORDER

1) DISASSEMBLING THE REDUCTION GEAR PART

- (1) Remove plugs (128, 3EA) and drain the reduction gear oil.
- (2) Loosen socket bolts (124, 16EA) and remove the cover (123).
 - ※ Remove the cover (123), after hook it, fit the eye bolt in a screw hole for use of the plug (128). If it's impossible, please remove the cover using the rod.
 - ※ You can have difficulty removing it because loctite is spread in the socket bolt (124).
 - ※ Tools
 - Hexagon wrench 8, 10

- (3) Remove drive gear (121).

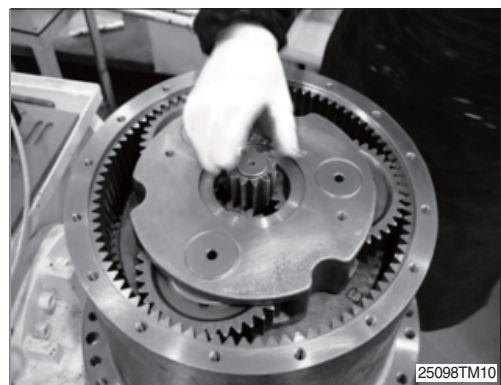

(4) Remove carrier No.1 assembly.

- ※ Carrier no.1 assembly consists of planetary gear (117), needle bearing (118), shaft bearing (107), carrier (134), thrust washer (131) and spring pin (122).

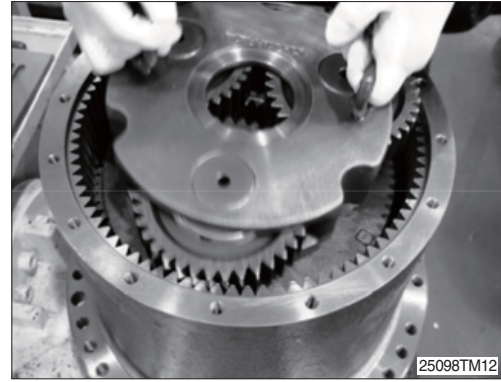

(5) Disassembling the carrier No.1 assembly.

① Drive spring pins (122) into shaft bearing (R) (107).

- ※ Please don't remove if repair isn't necessary.
- ※ Do not reuse the spring pin (122).

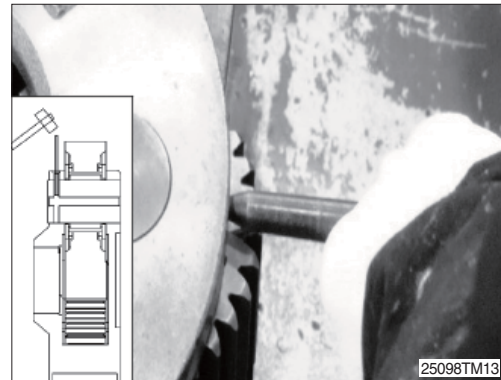

② Remove shaft bearing (R) (107), planetary gears (R) (117), thrust washer (R) (131), needle bearings (118) and thrust washer (R) (131).

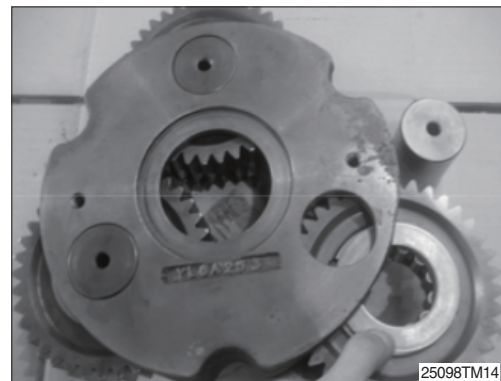

(6) Remove sun gear (114).

- ※ Snap ring (115) is assembled in sun gear (114). Don't remove it if not necessary.



(7) Remove the carrier No.2 assembly.

- ※ Remove it using a crane after M10 eye bolt is assembled.

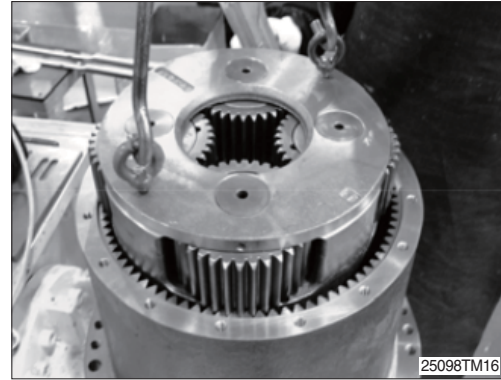

(8) Drive spring pins (110) into shaft bearing (F) (113)

- ※ Do not reuse the spring pin (110).

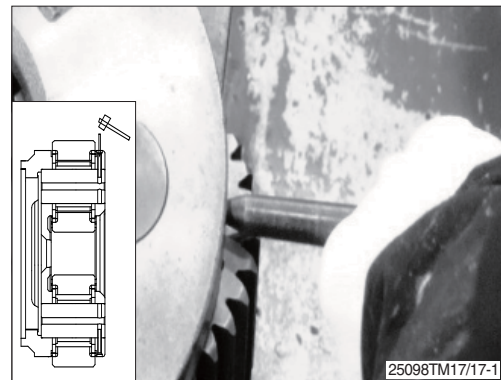

(9) Remove shaft bearing (113, 4EA).

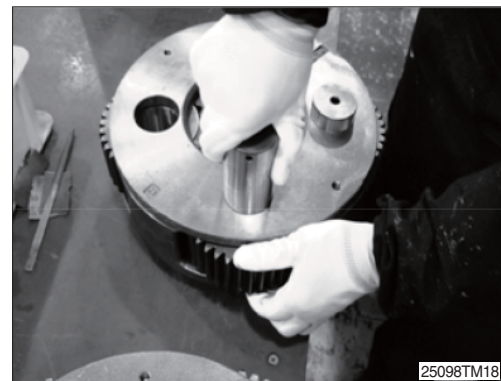

(10) Remove the thrust washer (F) (109), planetary gears (F) (108), needle bearings (111) and floating bushing (112) from carrier No.2 (103).

- ※ Each part consists of the 1st.

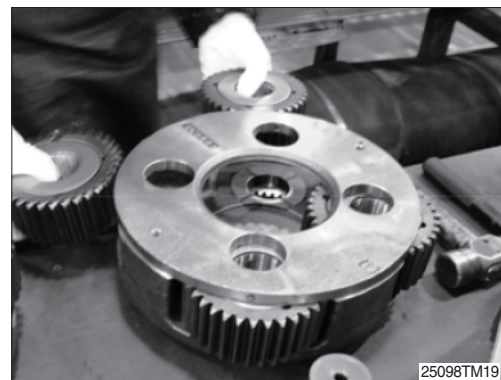

(11) Take off lock shim plate (136) by hammering on chisel or on similar tool placed at parting surface.

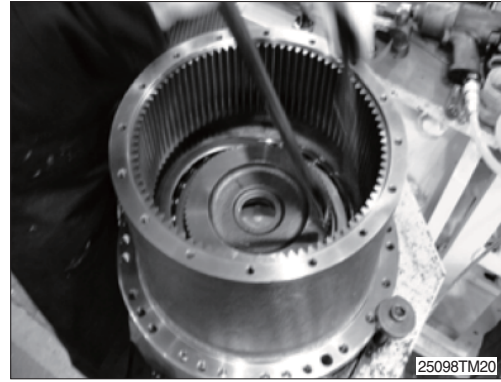

(12) Remove the hub (105) from the spindle (101).

- ※ Remove it using a crane after M16 eye bolt is assembled at the hub (105).

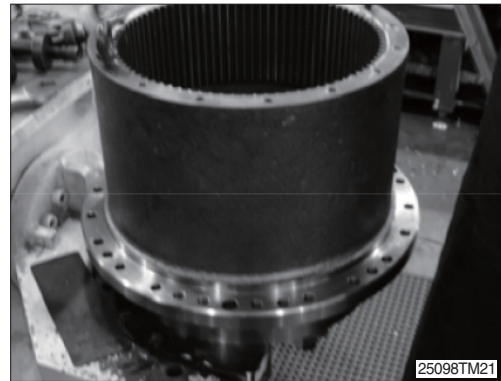

(13) Remove the distance piece (106) from the spindle (101).

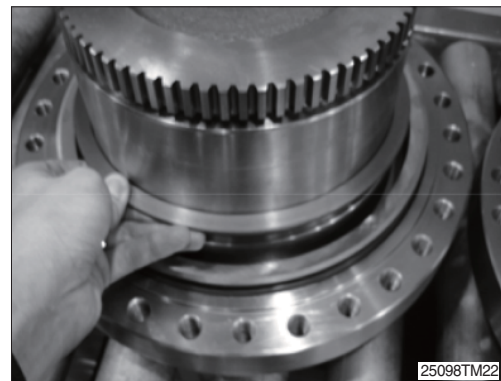

(14) Remove the floating seal (102) from the hub (105) and the spindle (101).

- ※ User can remove easily if using (-) driver.

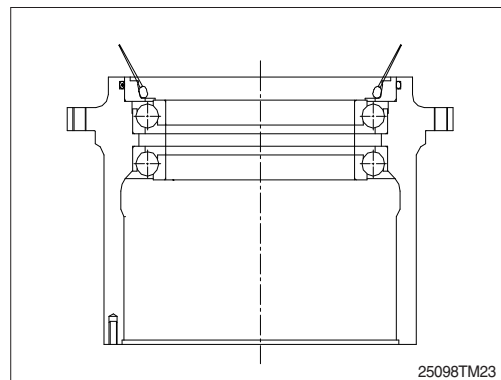

(15) The sealing (129), the angular bearing (125, 2EA), the O-ring (130) are assembled on the hub (105) with the floating seal (102).

- ※ Don't remove if not necessary.
In case of the removal, be careful not to scratch using aluminum rod or hammer.

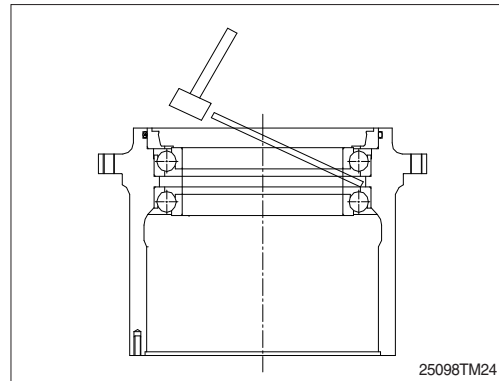

2) DISASSEMBLING THE HYDRAULIC MOTOR PART

(1) Remove the relief valve (2EA) from rear flange (1).

- ※ Tools
 - Hexagon socket 32
 - Torque wrench

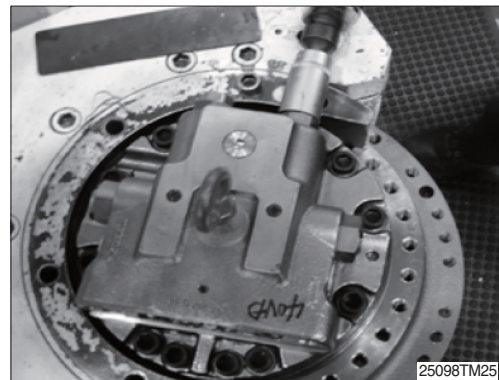

(2) Remove hexagon socket head bolts (43) from the rear flange (1).

- ※ Tools
 - Hexagon wrench 14

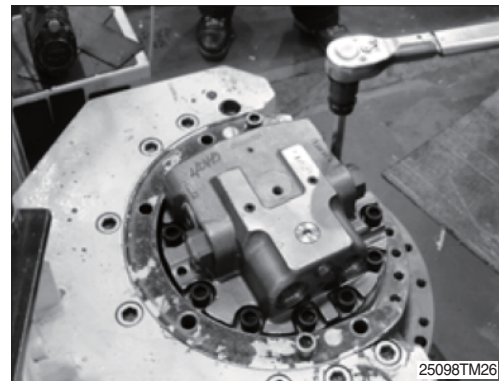

(3) Remove the rear flange (1) from the spindle (101).

(4) Remove the spring (213, 10EA) from the rear flange [1].

- ※ Remove the rear flange (1) carefully after taken using hands. Be careful not to detach the timing plate (209) and the spring (213) if twisted or beated by constraint.

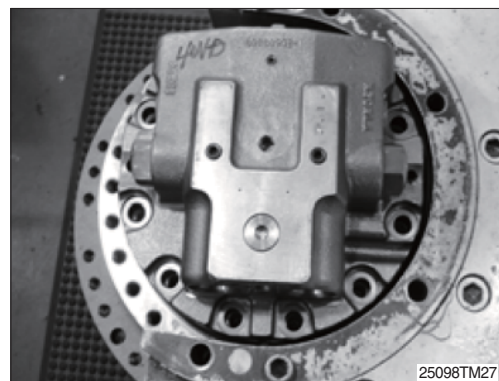

(5) Remove the parallel pin (42) from the spindle (101).

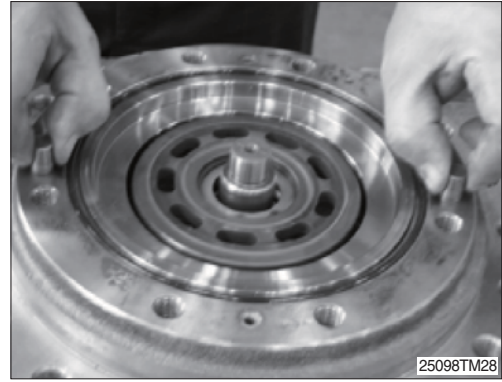

(6) Remove the O-ring (126) from the spindle (101).

※ Do not reuse the O-ring (126).

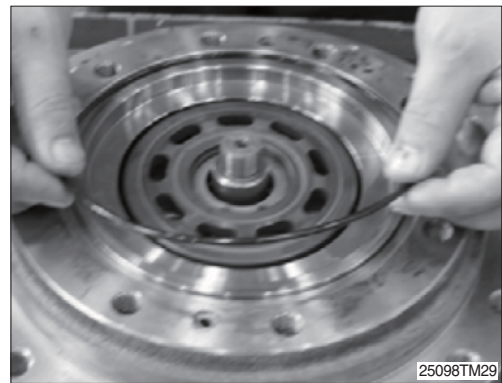

(7) Disassembling the rear flange (1) part

① Remove the timing plate (9) from the rear flange (1).

※ When removing the timing plate, user can have difficulty of the removal due to the close adhesion of rear flange (1) and oil. Remove it after fitting a rod through the hole which is used when a casting is detached.

※ Be careful of the leakage due to both surface scratch if using a sharp tool.

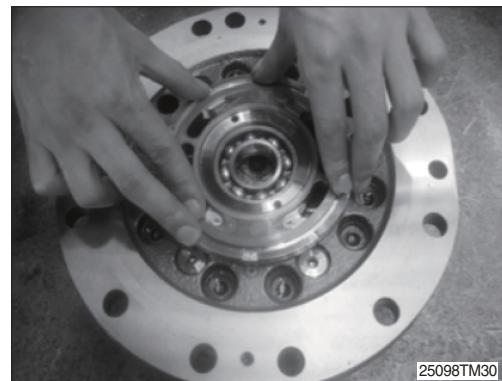

② Remove the parallel pin (41) from the rear flange (1).

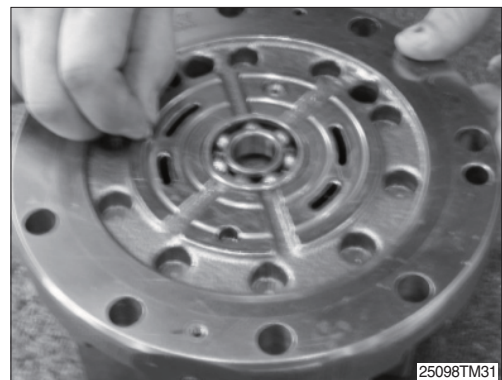

- ③ Remove the ball bearing (250) from the rear flange (1).

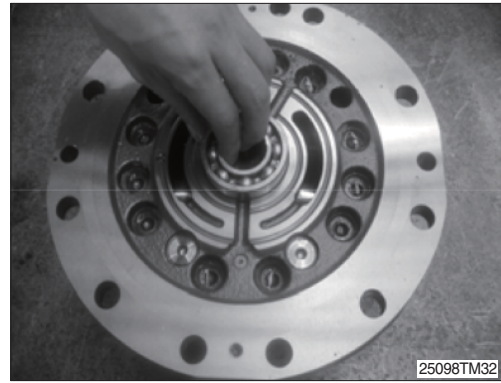

Disassembling the spool

- ① Remove two plugs (24) from the rear flange (1).
- ※ User can work easily if sub-disassembly was done on the reversal table.
 - ※ Tools
 - Hexagon socket 41
 - Torque wrench

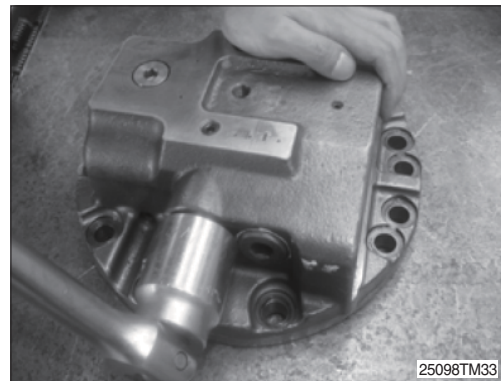

- ② Take out two springs (31), two stopper (25, 26) from the rear flange (1).
- ③ Remove the spool (23) from the rear flange (1).
- ※ Be careful not to damage the outer surface of the spool (23) and the sliding surface of the rear flange (1).
 - ※ Since the rear flange (1) and the spool (23) are of the selective fitting type, replace them together as a kit even if only one of the two parts is damaged.

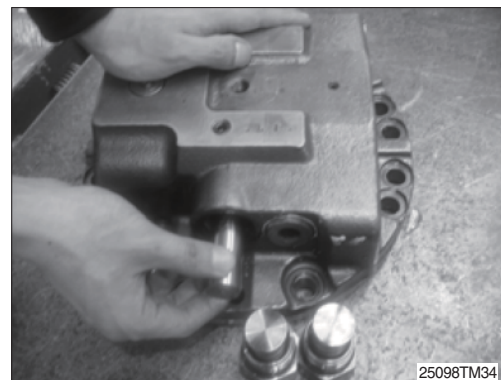

Disassembling the check valve

- ① Remove two plugs (29) from the rear flange (1).
- ※ User can work easily if sub-disassembly was done on the reversal table.
 - ※ Tools
 - Hexagon wrench 14

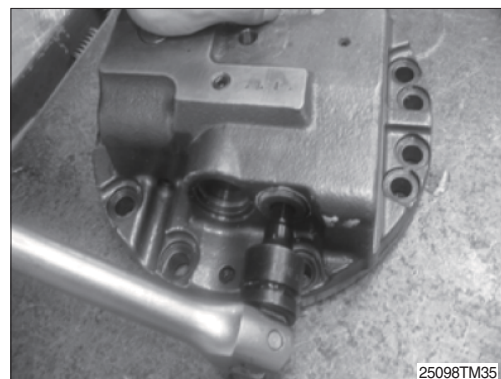

- ② Remove the spring (32, 2EA), valve (30, 2EA) from rear flange (1).

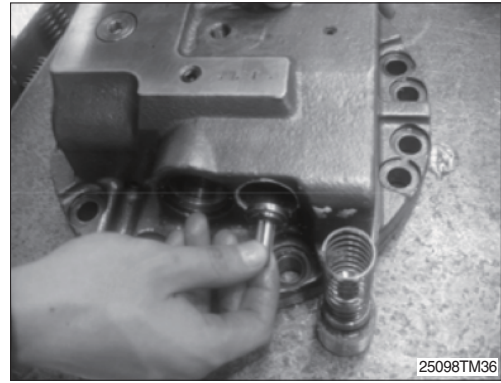

Disassembling the two speed valve

- ① Remove the plug (63) from the rear flange (1).
- ※ User can work easily if sub-disassembly was done on the reversal table.
 - ※ Tools
 - Hexagon wrench 10

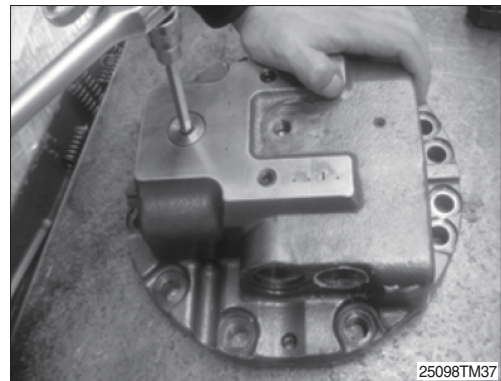

- ② Remove the spool (65) and spring (66) from rear flange (1).

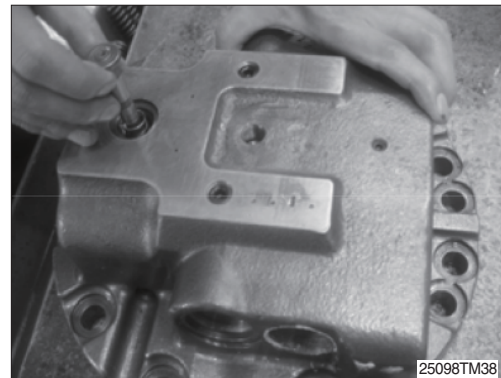

(8) Disassembling the parking brake

- ① Remove the piston (212) by injecting compressed air from the parking brake access hole in the spindle (101).
- ※ Use the protection cover on the upper part of spindle (101) when users put the pressed air into suddenly. Otherwise part damage and accident might go on because the piston (212) is rushed out of the spindle (101).



- ② Remove the O-rings (235, 239) and backup rings (247, 248) from the piston (212).

※ Do not reuse O-rings (235, 239) and backup rings (247, 248) after removal.

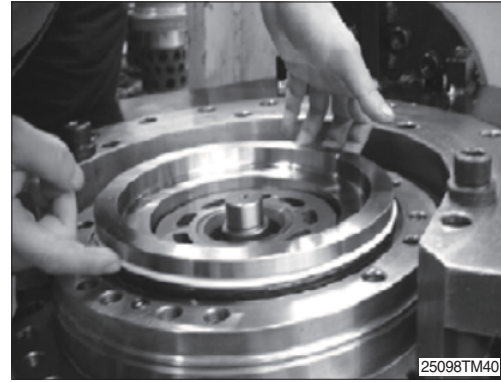

(9) Disassembling the hydraulic motor part

- ① Lay the travel motor body on the side.
② Drain out the oil from the travel motor.

※ Place an oil receptacle under the travel motor to receive the oil flowing out as the motor is being laid on the side.

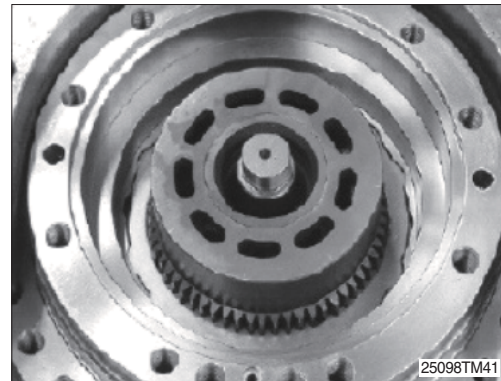

- ③ Hold the cylinder block (204) with both hands, and remove it from the shaft (202).
④ Remove the mating plates (216) and friction plates (215) from the cylinder block (204).

※ Before removal, hold the cylinder block (204) with both hands and turn it two to three times in a clockwise and a counterclockwise direction alternately to detach the shoe (206) from the swash plate (203).

※ Be careful that if an attempt is made to remove the cylinder block (204) without detaching the shoe (206) from the swash plate (203), then the piston, shoe and other parts that are connected to the cylinder block may come the cylinder loose and fall into the spindle.

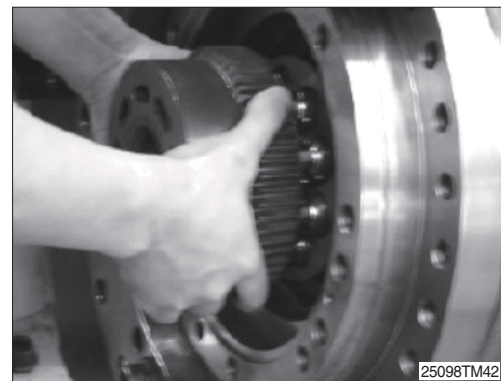

Disassembling the cylinder block kit

- ① Piston assembly [piston (205), shoe (206))] from the removed cylinder block (204).

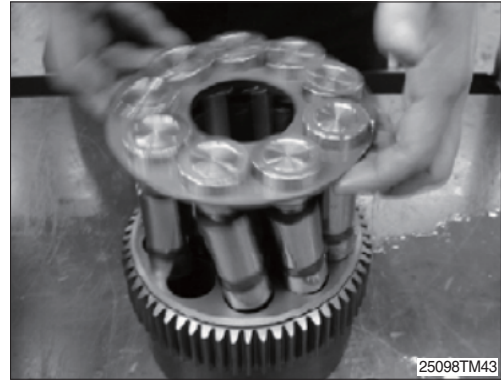

- ② Piston (205) and shoe (206) from the removed retainer plate (207).



- ③ Thrust ball (208) from the removed cylinder block (204).

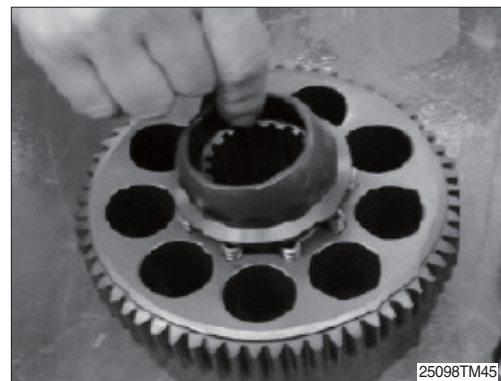

- ④ Spring (214, 9EA) from the removed cylinder block (204).

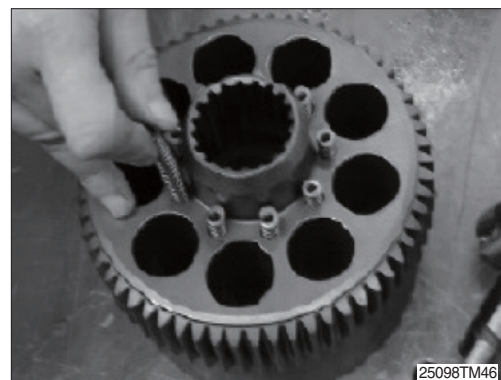

(10) Remove swash plate (203) from the shaft (202).

(11) Remove shaft (202) from the spindle (101).

- ※ When separating the swash plate, separate and turn it by using hands to free from intervention of the stopper.

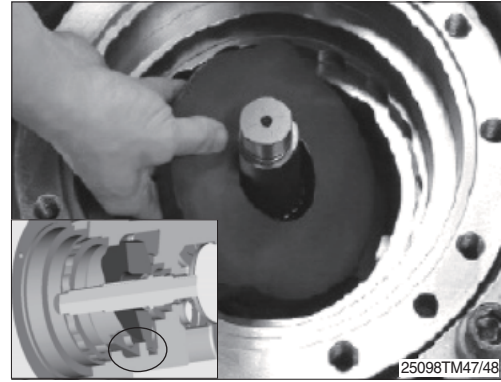

(12) Remove speed selector piston assembly [piston (261) and shoe (262)] from the spindle [101] by feeding compressed air from the access hole in spindle (101).

(13) Remove parallel pin (242) and pivot (267) from the spindle (101).

(14) Remove ball bearing (249) from the spindle (101).

- ※ Piston assembly ; Piston (261), Shoe (262)
- ※ Compressed air ; 3~5 kgf/cm² (43~71 psi)
- ※ When piston (261) or shoe (262) is damaged, if exchange is necessary, they have to be exchanged together because the separation is impossible. Use the protection cover on the upper part spindle when users put the pressed air into suddenly. Otherwise part damage and accident might go on because the piston is rushed out of the spindle.

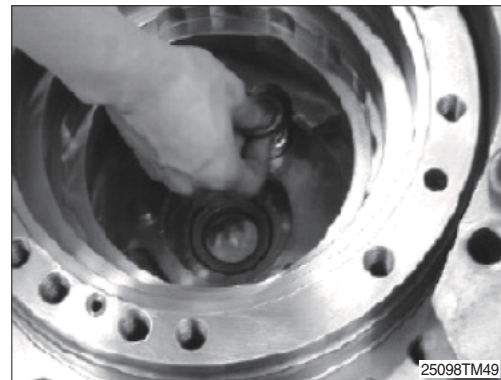

(15) Remove oil seal (232) from the spindle (101).

- ※ Remove the oil seal (232) by hammering using (-) driver.
- ※ Do not reuse the oil seal (232).

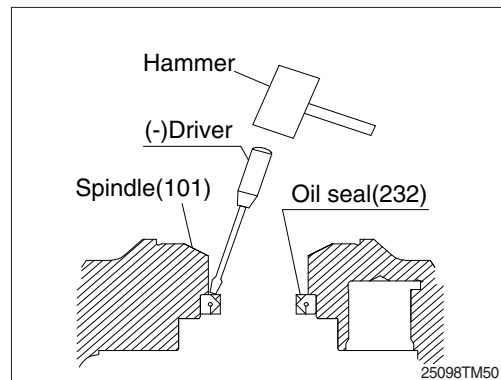

4. REASSEMBLY

4.1 GENERAL PRECAUTIONS

- 1) Reassemble in a work area that is clean and free from dust and dirt.
- 2) Handle parts with bare hands to keep them free of lint contaminants.
- 3) Repair or replace the damaged parts.
Each parts must be free of burrs its corners.
- 4) Do not reuse O-ring, oil seal and floating seal that were removed in disassembly. Provide the new parts.
- 5) Wash all parts thoroughly in a suitable solvent. Dry thoroughly with compressed air.
Do not use the cloths.
- 6) When reassembling oil motor components of travel motor, be sure to coat the sliding parts of the motor and valve with fresh hydraulic oil. (NAS class 9 or above)
- 7) Use a torque wrench to tighten bolts and plugs, to the torque specified as follows.

4.2 REASSEMBLY PROCEDURE

1) REASSEMBLE THE HYDRAULIC MOTOR PART

- (1) Install oil seal (232) into the oil seal hole of spindle (101).
 - ※ Apply lithium grease to the lip portion of oil seal (232) position the squarely over the bore of spindle (101).

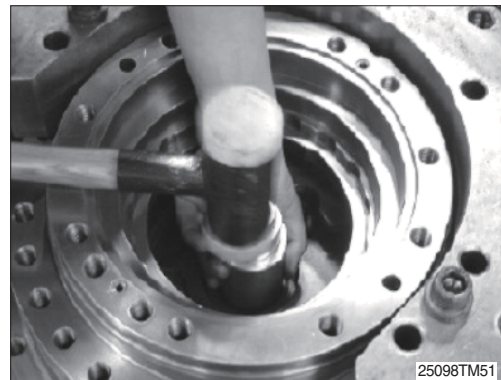

- (2) Install parallel pin (242, 2EA) and two speed piston assembly (261, 262) into the spindle (101).

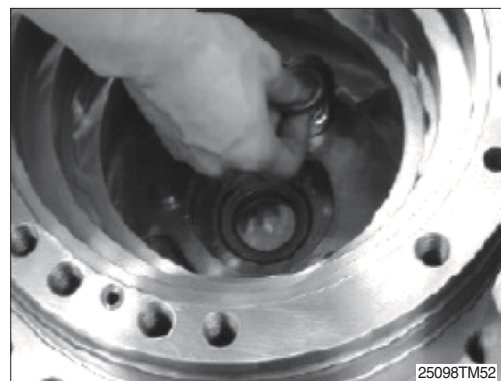

(3) Install shaft (202) into the spindle (101).

※ Assemble after applying grease on oil seal lip (232).

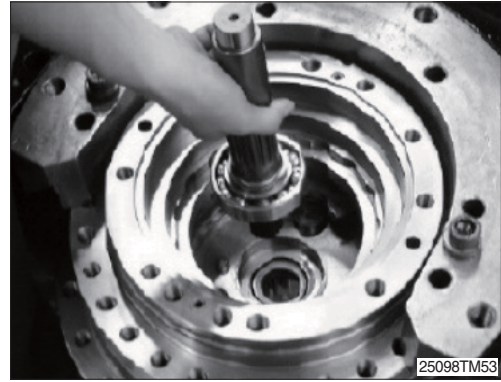

(4) Install pivot (267, 2EA) into the spindle (101).

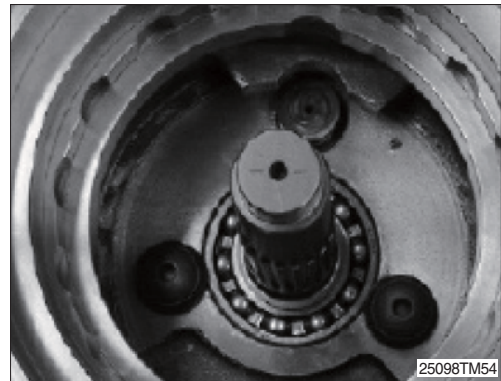

(5) Install swash plate (303) to the spindle (101).

※ The swash plate (203) and the 2 speed stopper of the spindle are interferenced. Install the swash plate (203) after rotating. And then install it as the regular position.

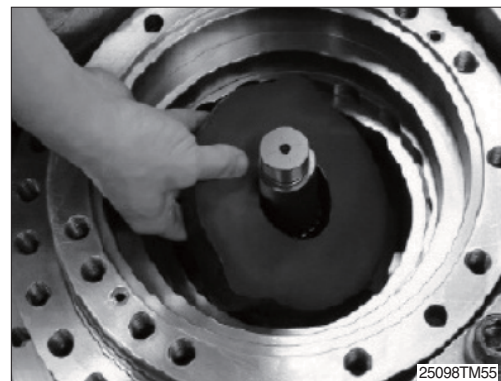

(6) Reassemble the cylinder block kit

① Install spring (214, 9EA) to the cylinder block (204).

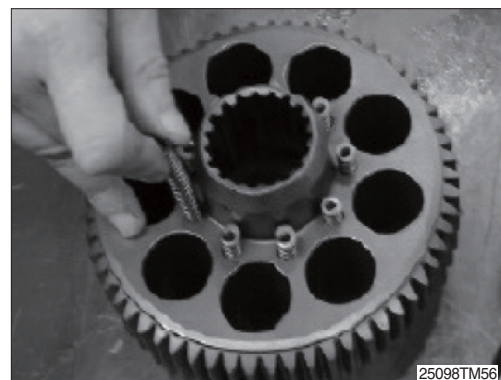

- ② Install thrust ball (208) to the cylinder block (204).

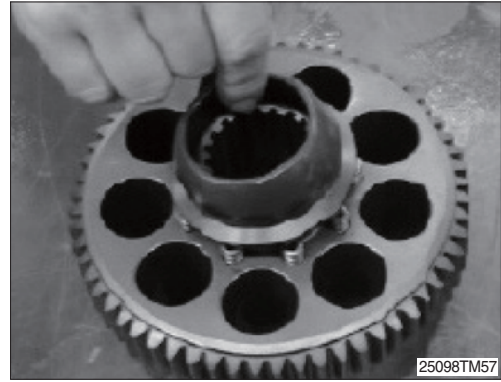

- ③ Insert piston assembly [piston (205) and shoe (206)] into retainer plate (207).
④ Mount the piston assembly into the cylinder block (204).

※ After mounting, immerse the entire them in a working fluid.

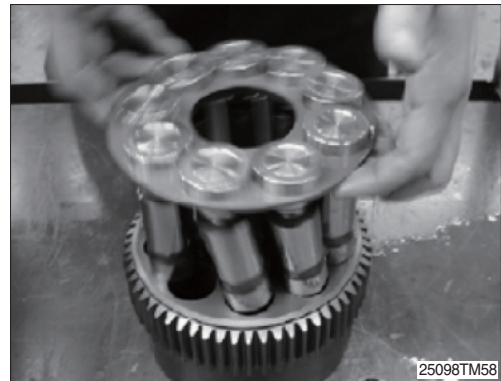

- (7) Install cylinder block (204) assembly to the shaft (202).

- ※ After fitting splines of both cylinder block (204) and shaft (202), assemble them.
※ After installing the cylinder (204), confirm whether it revolves or not by turning using both hands.
※ Motor is malfunction when it isn't revolve.

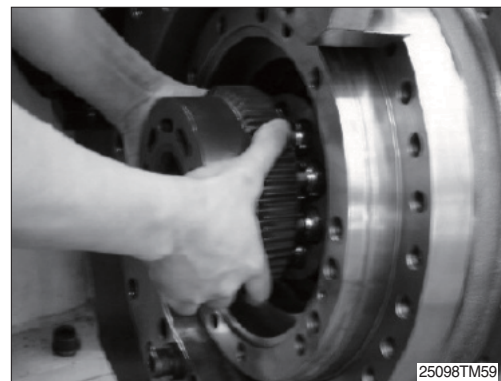

(8) Reassemble the parking brake

- ① Install mating plate (216) first and then a friction plate (215), one by one, into the grooves of the outer surface of the cylinder block (204).

※ Immerse the friction plates (215) in a working fluid before fitting them into the grooves.

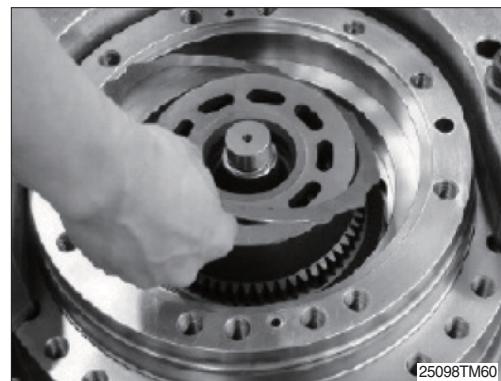

- ② Install O-ring (275, 2EA) into the spindle (101).

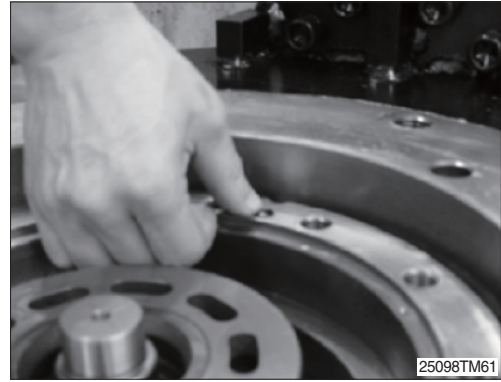

- ③ Install two O-rings (235, 239) and two back up ring (247, 248) in then O-ring grooves.

- ④ Mount a piston (212) in the spindle (101).

- ※ Apply a thin coat of grease to the O-rings (235, 239).
- ※ If the piston (212) does not fit into the spindle (101) because of the resistance of the O-ring, tap the edge of the piston (212) lightly and equally with a plastic hammer.
- ※ Be careful not to damage the O-ring and back up ring at this time.



- ⑤ Insert a O-ring (126) into spindle (101).

- ⑥ Insert a paralell pin (42, 2EA) into spindle (101).

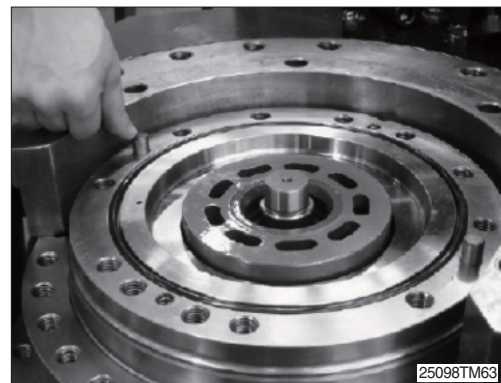

1) REASSEMBLE THE REAR FLANGE PART [1]

(1) Reassemble the check valve

① Install O-ring (37, 2EA) on the plug (29, 2EA).

※ Apply grease to the O-ring (37).

② Install spring (32) and a valve (30) into the plug (29).

③ Install plug (29) into the rear flange (1).

※ Install a spring (32) and a valve (30) into the plug (29), and then grease the spring (32) and the valve (30) and hand-lock the former.

④ Install plug (29) in conjunction with the spring (32) and the valve (30) into the rear flange (1), and tighten the plug to the required torque.

※ Tightening torque : $26 \pm 4.0 \text{ kgf} \cdot \text{m}$ ($188 \pm 28.9 \text{ lbf} \cdot \text{ft}$)

※ Tools

- Adapter for hexagon wrench 14
- Torque wrench

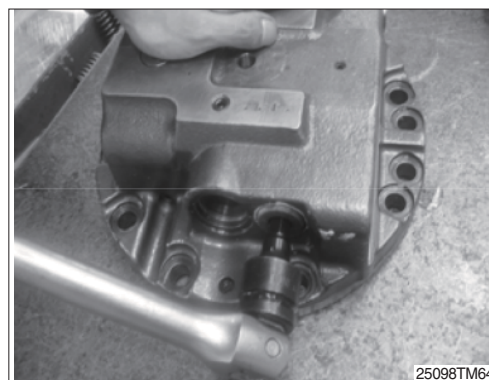

(2) Reassemble the spool

① Install spool (23) into the rear flange (1).

※ Before installing the spool (23), apply hydraulic oil to the spool. Be careful not to damage the spool's surface and the inner of rear flange (1).

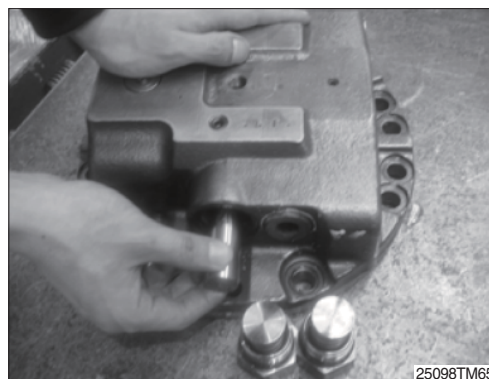

- ② Install O-ring (36) on the plug (24).
- ③ Install spring (31) and a stopper (25, 26) into the plug (24).
- ④ Install plug (24) into the rear flange (1).
- ⑤ Tighten the plug (24) to the required torque.

- ※ Apply grease to the O-ring (36).
- ※ Tightening torque : $45 \pm 9 \text{ kgf} \cdot \text{m}$ ($325 \pm 65.1 \text{ lbf} \cdot \text{ft}$)
- ※ Exchange it as the rear flange kit if the exchange is necessary, because the rear flange (301), the spool (323) insist of the rear flange kit.
- ※ Sochet (#41)/Torque for hexagon wrench.
- ※ Tools
 - Hexagon socket 41
 - Torque wrench

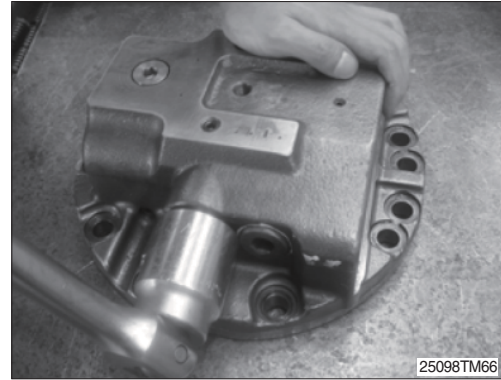

(3) Reassemble the two speed valve

- ① Install O-rings (46) on plugs (63).
- ② Insert a spool (65) and spring (66) into the rear flange (1).

- ※ Apply grease to the O-ring (46).
- ※ Apply hydraulic oil to the spool (65), while the spool (65) is installed into the rear flange (1).
- ※ Be careful not to damage the hole's inner of the rear flange (1) and the spool (65) outer. It brings on low efficiency of the travel motor because of the leakage increase after reassembling.
- ※ The shaft center should align with the hole center because of little gap.
- ※ It is in order to protect the damage and smooth assembling of the rear flange (1) and the spool (65).

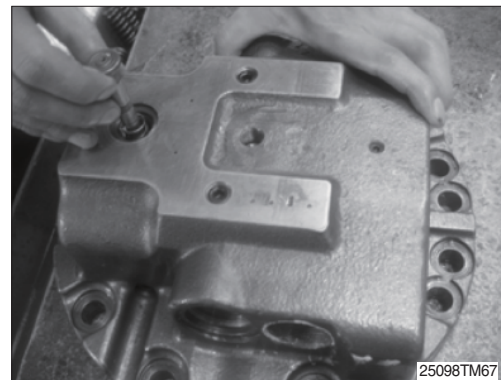

- ③ Insert a plug (63) into the rear flange (1).

- ※ Tightening torque : $10 \pm 2 \text{ kgf} \cdot \text{m}$ ($72.3 \pm 14.5 \text{ lbf} \cdot \text{ft}$)
- ※ Tools
 - Adapter for hexagon wrench 10
 - Torque wrench

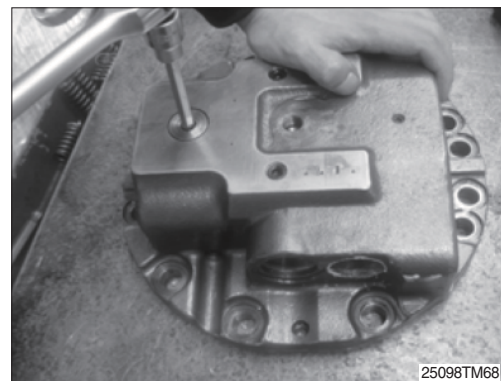

(4) Assembling of the rear flange's inner parts

① After installing the O-ring (74) on the plug (52), install the steel ball (68) and the plug (52) into the rear flange (1).

- ※ Apply grease to the O-ring (74).
- ※ Do not disassemble and assemble if not necessary.

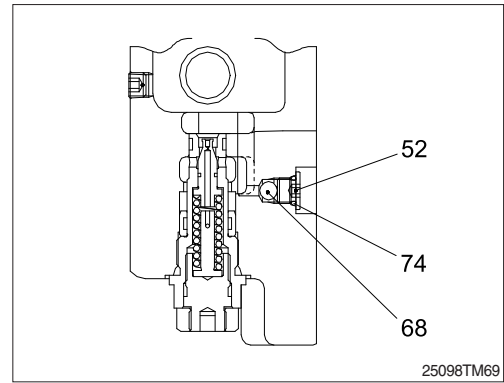

② Install orifice (71), filter (79) into the rear flange (1). Caulk it after assembling certainly.

- ※ Do not disassemble and assemble if not necessary.

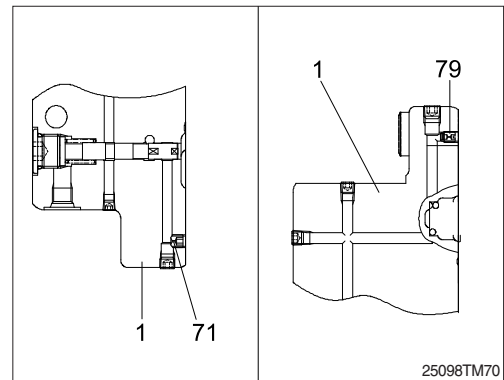

(5) Insert a ball bearing (250), timing plate (209), parallel pin (41, 1EA) and spring (213, 12EA) into the rear flange (1).

- ※ Be careful not so that the spring (213) and the timing plate (209) should not separate from the rear flange (1).
- ※ Apply hydraulic oil to the ball bearing (250).

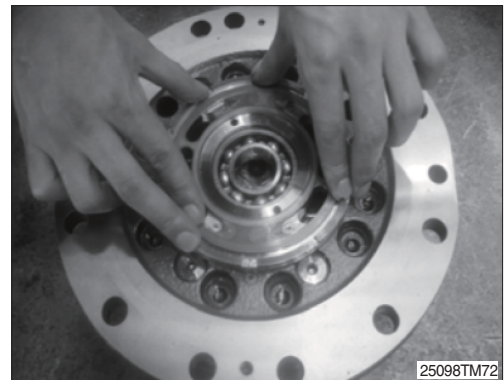
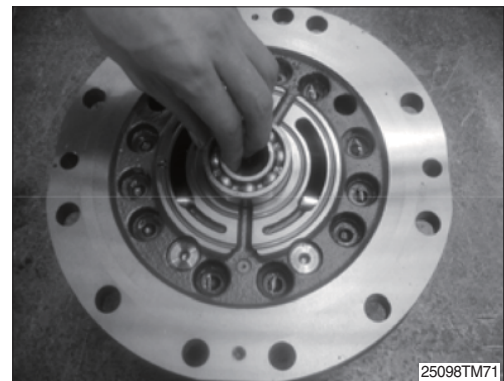

(6) Reassemble the rear flange (1) and spindle (101).

① Mount the rear flange (1) on the spindle (101).

- ※ When the rear flange (1) is mounted on the spindle (101), fix the spring (13) applied grease to not drop.

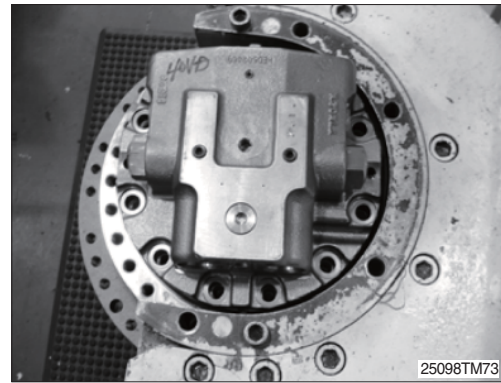

② Tighten the socket bolt (43) into the spindle (101) to the required torque.

- ※ Tightening torque : $5.9 \pm 1.0 \text{ kgf} \cdot \text{m}$ ($42.7 \pm 7.2 \text{ lbf} \cdot \text{ft}$)
- ※ Tools
 - Adapter for hexagon wrench 14
 - Torque wrench

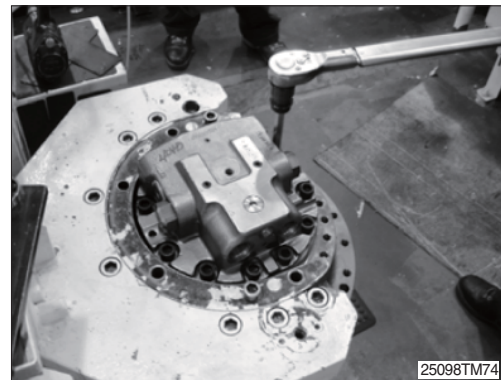

(7) Tighten the relief valve into the rear flange (1) to the required torque.

- ※ Tightening torque : $25 \pm 5 \text{ kgf} \cdot \text{m}$ ($181 \pm 36.2 \text{ lbf} \cdot \text{ft}$)
- ※ Tools
 - Hexagon socket 32
 - Torque wrench

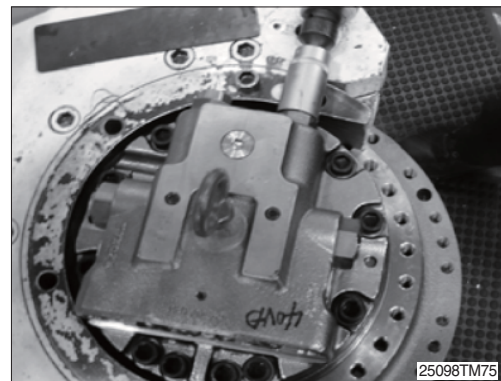

3) THE REDUCTION GEAR ASSEMBLY

(1) Rotate the travel motor through 180 degrees to make the spindle side face upward.

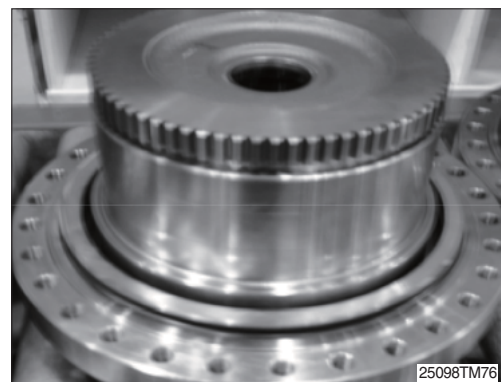

(2) Install floating seal (102) on the spindle (101).

※ Apply grease to the floating seal (102).

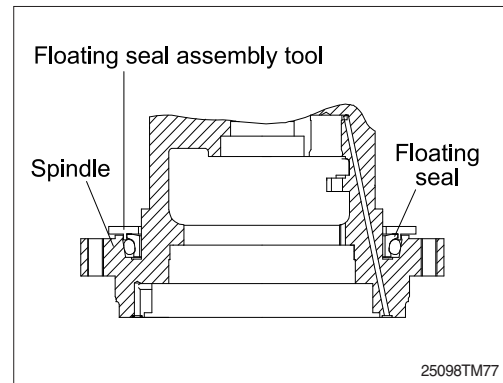

(3) Hub assembly

① Install angular bearing (125) into the hub (105).

※ Be careful for the insert direction.

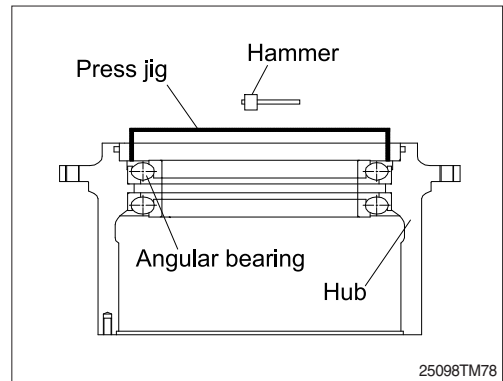

② Insert the O-ring (130), the sealing (129) in the hub (105).

※ Apply grease to the O-ring (130) thinly.

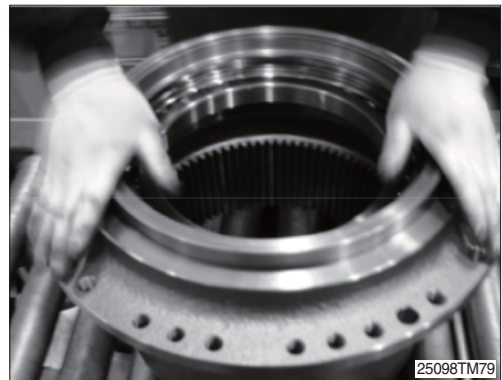

③ Install floating seal (102) on the hub (105).



※ Apply grease to the floating seal (102).

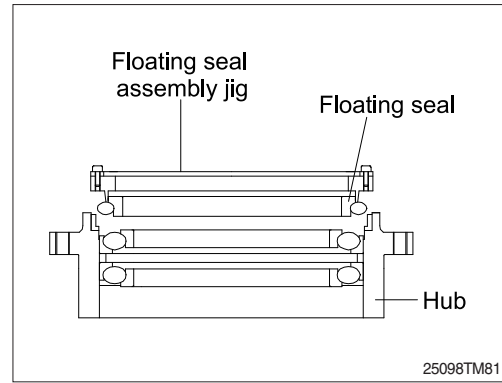

④ Install distance piece (106) into the spindle.

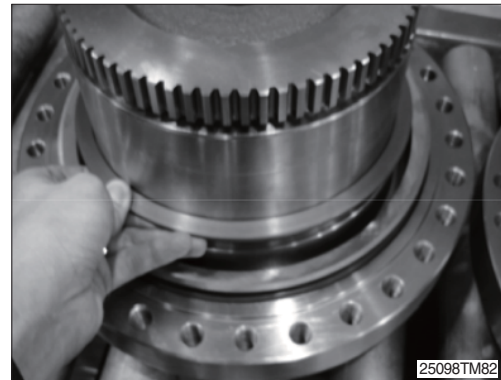

⑤ Install the hub assembly into the spindle.

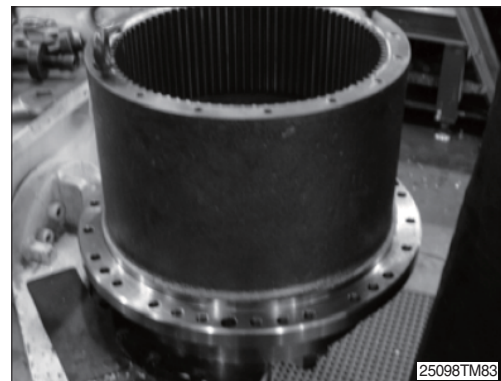

- ⑥ Use a press, and press inner lace of bearing (125) into its full depth.
- ⑦ While pressing flange of spindle (101), install shim plate (136) into groove.

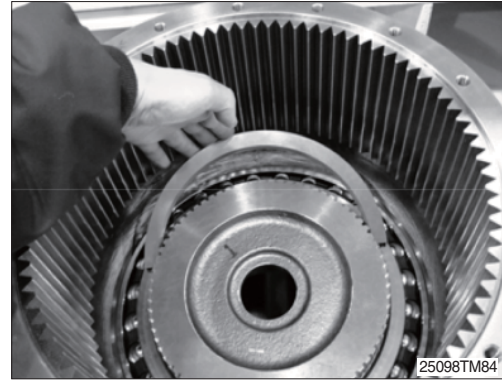

- ⑧ Install thrust washer (F) (109), planetary gears (F) (108), needle bearings (111) and floating bushing (112) from carrier No.2 (103).

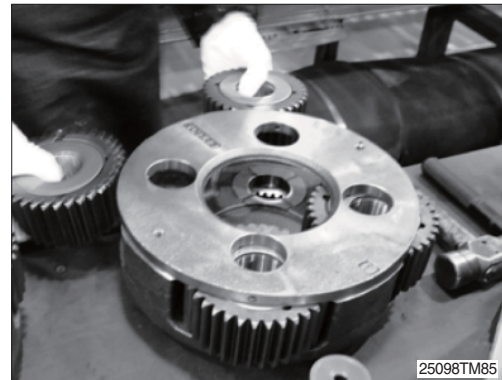

- ⑨ Install shaft bearing (113) into the carrier No.2 (103).



- ⑩ Install spring pin (110) into the carrier No.2 (103).

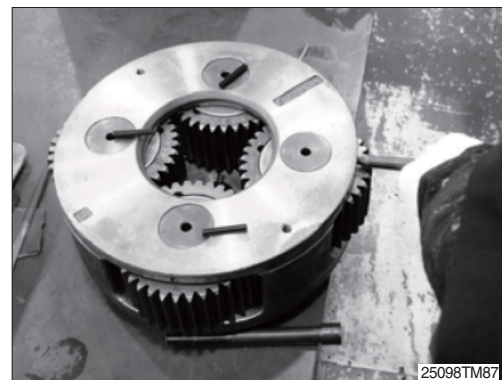

⑪ Place carrier No.2 assembly into hub (105).

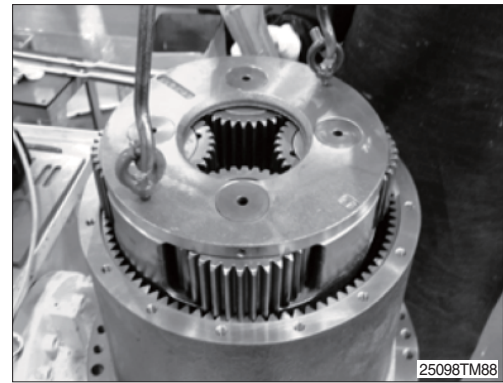

⑫ Fit the snap ring (115) on the sun gear (114).

※ Tools

· Snap ring plier (C-75(S))

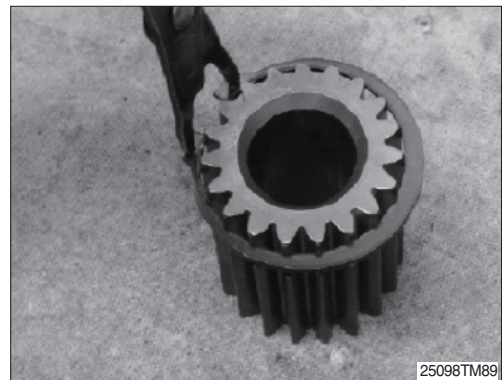

⑬ Install sun gear (114).

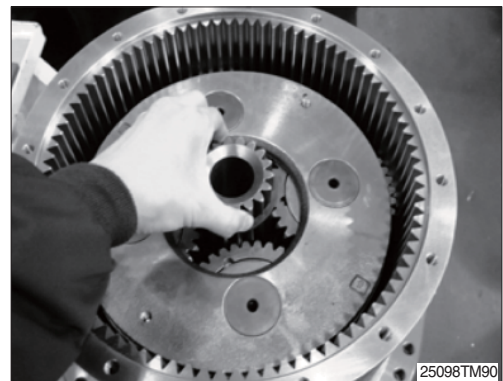

⑭ Install thrust washer (R) (131), planetary gears (R) (117), needle bearings (118) and shaft bearing (R) (107) from carrier No.1 (134).

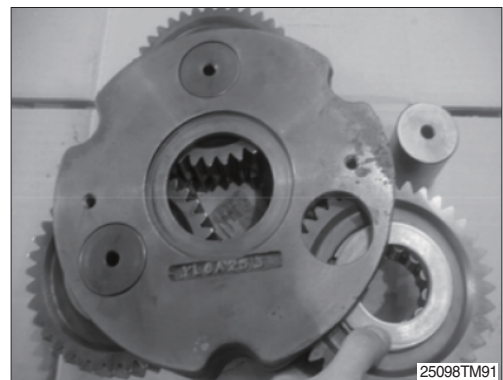

- ⑮ Install the spring pin (122) into the carrier No.1 (134).

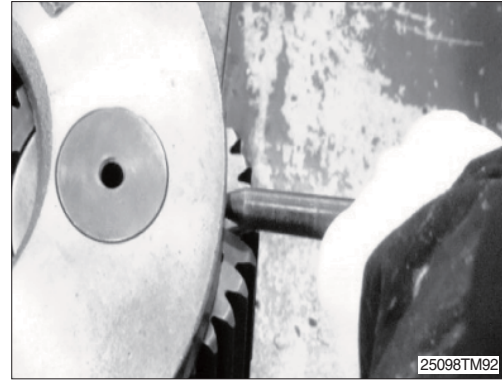

- ⑯ Place carrier No.1 assembly into hub (105).

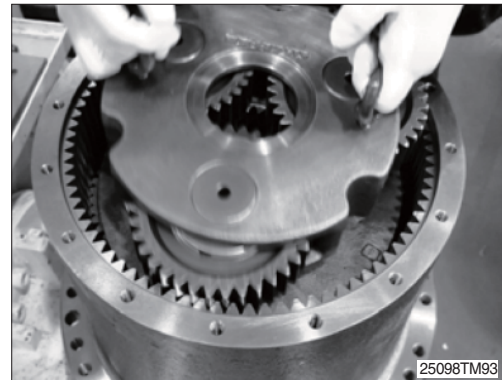

- ⑰ Install drive gear (121) in the carrier No.1 assembly.

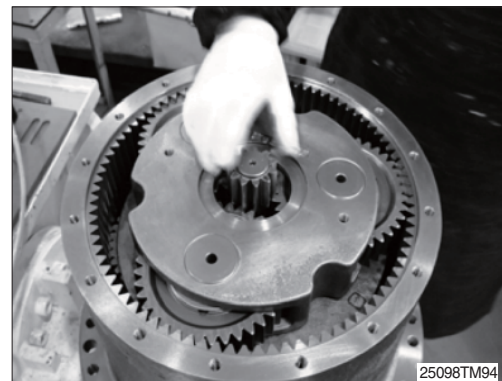

- ⑱ Install thrust plate (133) in the cover (123).

※ Apply grease to the thrust plate (133).

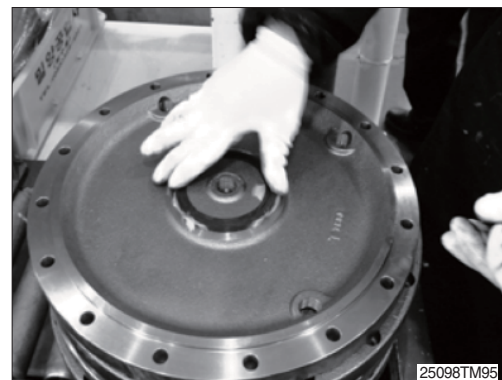

⑱ Install thrust washer (M) (132) in the cover (123).

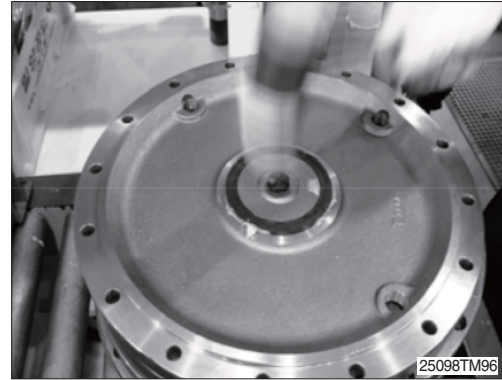

⑳ Apply sealant to the cover (123) after installing with the hub (105).

※ Tools

- Sealant : Silicone rubber (780-RTV)

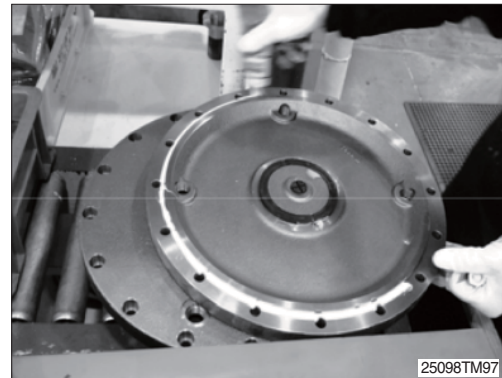

㉑ Mount the cover (123) on the hub (105).

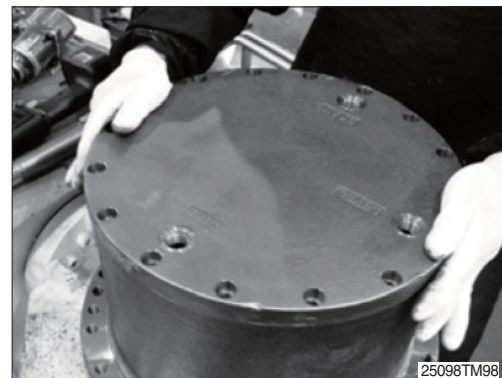

㉒ Tighten the socket bolt (124, 16EA) to the specified torque.

※ Tightening torque : 5.9 ± 1.0 kgf · m (42.7 ± 7.2 lbf · ft)

※ Tools

- Adapter for hexagon wrench 8
- Torque wrench

※ Apply loctite to the socket bolt (124) and then install it.

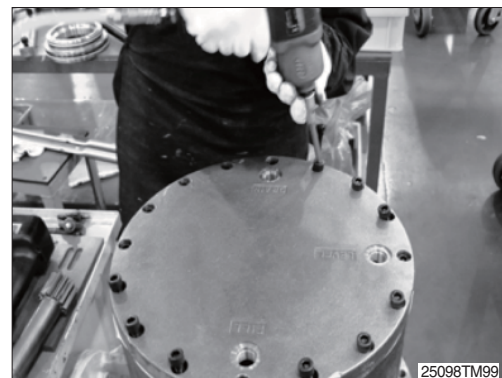

- ②③ Install O-ring (38) in the plug (128).
- ②④ Tighten the plug (128) to the specified torque into the cover (123).
- ※ Apply grease to the O-ring (38).
- ※ Tightening torque : $10 \pm 2.0 \text{ kgf} \cdot \text{m}$
($72.3 \pm 14.5 \text{ lbf} \cdot \text{ft}$)
- ※ Tools
 - Adapter for hexagon wrench 10
 - Torque wrench

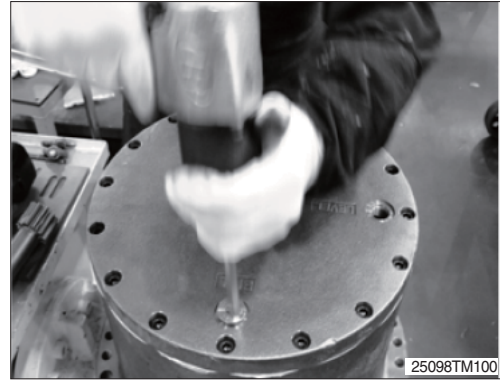

3.3 CHECKING FACTS AFTER ASSEMBLY

1) AIR TEST OF REDUCTION GEAR

Disassemble plug (032) of reduction gear part. When compressed air (0.3 kgf/cm^2) is inserted that in water during the 2 minutes, it should be not happened air bubble.

Fill the gear oil.

- Oil amount : 3.3 liter (0.87 U.S.gallon)

2) AIR TEST OF HYDRAULIC MOTOR

One port should be opened, the others port should be closed. When compressed air (3 kgf/cm^2) is inserted opened port in water during the 2 minutes, it should be not happened air bubble.

Fill the hydraulic oil.

- Oil amount : 1.0 liter (0.26 U.S.gallon)

GROUP 6 TRAVEL DEVICE (TYPE 2)

1. REMOVAL AND INSTALL

1) REMOVAL

- (1) Swing the work equipment 90 ° and lower it completely to the ground.
- (2) Operate the control levers and pedals several times to release the remaining pressure in the hydraulic piping.
- (3) Loosen the breather slowly to release the pressure inside the hydraulic tank.

▲ Escaping fluid under pressure can penetrate the skin causing serious injury.

※ When pipes and hoses are disconnected, the oil inside the piping will flow out, so catch it in oil pan.

- (4) Remove the track shoe assembly.
For details, see **removal of track shoe assembly**.
- (5) Remove the cover.
- (6) Remove the hose.
※ Fit blind plugs to the disconnected hoses.
- (7) Remove the bolts and the sprocket.
- (8) Sling travel device assembly (1).
- (9) Remove the mounting bolts (2), then remove the travel device assembly.
· Weight : 360 kg (790 lb)

2) INSTALL

- (1) Carry out installation in the reverse order to removal.
- (2) Bleed the air from the travel motor.
 - ① Remove the air vent plug.
 - ② Pour in hydraulic oil until it overflows from the port.
 - ③ Tighten plug lightly.
 - ④ Start the engine, run at low idling, and check oil come out from plug.
 - ⑤ Tighten plug fully.
- (3) Confirm the hydraulic oil level and check the hydraulic oil leak or not.

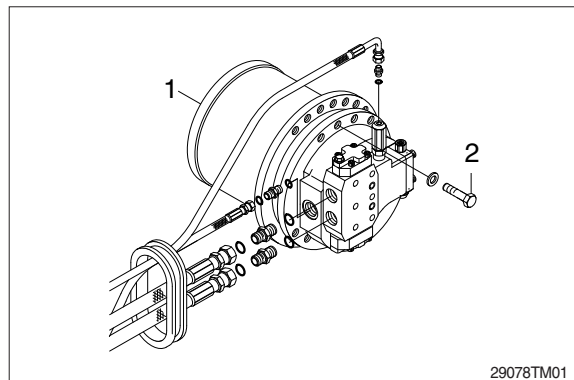

2. SPECIFICATION

1) TRAVEL MOTOR

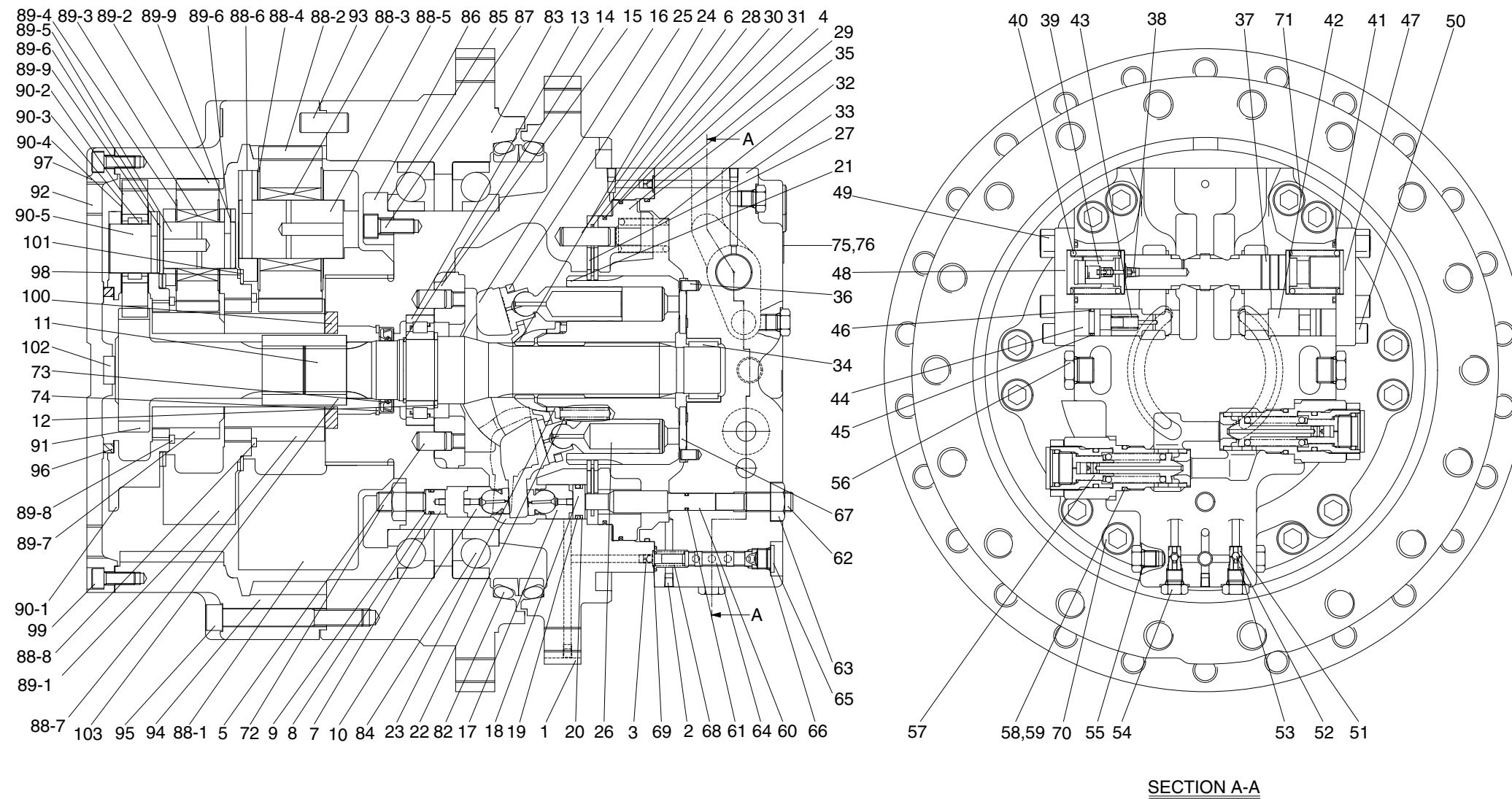

SECTION A-A

29092TM30

1 Casing	16 Plate	31 Ring	46 Back up ring	61 O-ring	83 Housing	89-1 Carrier No.2	91 Sun gear No.1
2 Plug	17 Piston	32 Spring	47 Cap	62 Lock screw	84 Bearing	89-2 Planetary gear No.2	92 Plug
3 Screw	18 Stopper	33 Valve casing	48 Cap	63 Nut	85 Shim	89-3 Needle No.2	93 Lock pin
4 Screw	19 O-ring	34 Needle bearing	49 Bolt	64 Spool	86 Retainer	89-4 Thrust washer No.2	94 Ring gear
5 Pin	20 Back up ring	35 O-ring	50 Socket bolt	65 Plug	87 Bolt	89-5 Pin No.2	95 Bolt
6 Pin	21 Cylinder block	36 Pin	51 Seat	66 O-ring	88 Carrier No.3	89-6 Spring pin No.2	96 Thrust ring No.1
7 Stopper	22 Cylinder spring	37 Spool	52 Steel ball	67 Valve plate	88-1 Carrier No.3	89-7 Sun gear No.2	97 Cover
8 O-ring	23 Spacer	38 Screw	53 Stopper	68 Spring	88-2 Planetary gear No.3	89-8 Snap ring No.2	98 Thrust ring No.2
9 Back up ring	24 Guide	39 Damping check	54 Plug	69 O-ring	88-3 Needle No.3	89-9 Spring pin No.2	99 Bolt
10 Piston	25 Plate	40 Spring	55 O-ring	70 Socket bolt	88-4 Thrust washer No.3	90 Carrier No.1	100 Motor ring
11 Shaft	26 Piston & Shoe assy	41 O-ring	56 Plug	71 Socket bolt	88-5 Pin No.3	90-1 Carrier No.1	101 Thrust ring No.3
12 Spacer	27 Plate	42 Plunger	57 Relief valve	72 Lock screw	88-6 Spring pin No.3	90-2 Planetary gear No.1	102 Pad
13 Roller bearing	28 Plate	43 Spring	58 O-ring	73 Oil seal	88-7 Sun gear No.3	90-3 Needle bearing No.1	103 Coupling
14 Stop ring	29 Brake	44 Stopper	59 Back up ring	74 Lock ring	88-8 Snap ring No.3	90-4 Thrust washer No.1	
15 Support	30 Ring	45 O-ring	60 Rod	82 Floating Seal	89 Carrier No.2	90-5 Pin No.1	

2) TOOL AND TIGHTENING TORQUE

(1) Tools

Name of tools	B-size	Name of part applied
Hexagonal L-Wrench	4	Plug (2), Orifice screw (3, 4, 38)
	8	Hex socket bolt (50), Lock screw (62, 72), Plug (65)
	10	Hex socket bolt (49)
	46	Hex (57)
Socket wrench/ spanner	19	Hp plug (54)
	24	Hex nut (63)
	27	Hp plug (56)
Snap-ring plier (for holes, axis)		Ring stop (14), Ring lock (74)
Solder hammer		Needle bearing (34), Pin (5, 6, 36)
Torque wrench		Size : 500, 3000
Jig for assembling oil seal		Oil seal (73)
Induction heating apparatus for bearing		Roller bearing (13)

(2) Tightening torque

NO.	Part name	Standard	Size	Torque	
				kgf · m	lbf · ft
2	Plug	NPTF 1/16	4	0.9±0.2	6.51±1.45
3, 4, 38	Orifice screw	NPTF 1/16	4	0.7	5.06
49	Hex socket bolt	M12	10	10	72.33
50	Hex socket bolt	M10	8	6.7	48.46
54	Plug	PF 1/4	19	3.7	26.76
56	Plug	PF 1/2	27	11	79.56
57	Relief valve	HEX 46	46	18±1.0	130±7.0
63	Nut	M16	24	24	173.59
65	Plug	PF 3/8	8	7.5	54.25
70, 72	Hex socket bolt	M16	14	24	173.59
71	Hex socket bolt	M16	14	24	173.59

2. DISASSEMBLING

1) GENERAL INSTRUCTIONS

- (1) Generally, hydraulic equipment is precisely manufactured and clearances between each parts are very narrow. Therefore, disassembling and assembling works should be performed on the clean place where dusts hardly gather. Tools and kerosene to wash parts should also be clean and handled with great care.
 - (2) When motor is removed from the host machine, wash around the ports sufficiently and put the plugs so that no dust and/or water may invade. Take off these plugs just before the piping works when re-attach it to the host machine.
 - (3) Before disassembling, review the sectional drawing and prepare the required parts, depending on the purpose and the range of disassembling.
Seals, O-rings, etc., if once disassembled, are not reusable.
There are some parts that should be replaced as a subassembly.
Consult with the parts manual in advance.
 - (4) The piston can be inserted to whichever cylinder block for the initial assembling.
However, their combination should not be changed if they are once used. To reuse them, put the matching mark on both pistons and cylinder block before disassembling.
- ▲ Take great care not to pinch your hand between parts while disassembling nor let fall parts on your foot while lifting them.**

2) DISASSEMBLING TRAVEL MOTOR

(1) Fix a hydraulic motor on jig with four pieces of bolts (M16×60L).

※ When rotating jig up to 90° in disassembling and assembling, fix a motor making drain plug (56) faced to the bottom.



300072TM20

(2) After disassembling drain plug (56), let an oil in a case of a motor discharged.

※ Check whether manufactured chips or metal dust are added in a drain oil.



300072TM21

300072TM21A

(3) In order to making the out-put axis of a hydraulic motor faced upward, disassemble ring lock (74) with a plier after rotating jig up to 90° in disassembling and assembling.



300072TM22

(4) Disassemble hexagon socket bolts (70, 71) holding valve casing.

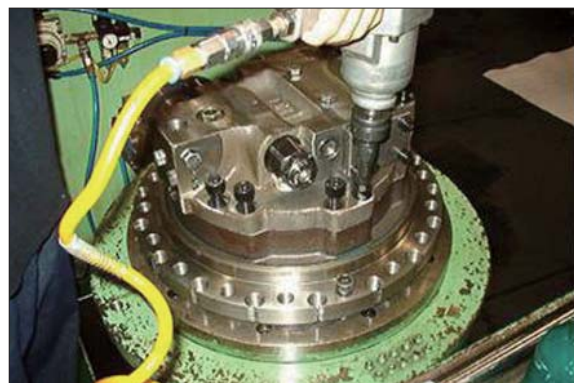

300072TM23

- (5) After detaching valve casing sub, disassemble valve plate (67).
 ※ In case of serious abrasion of valve plate, exchange it to a new one.

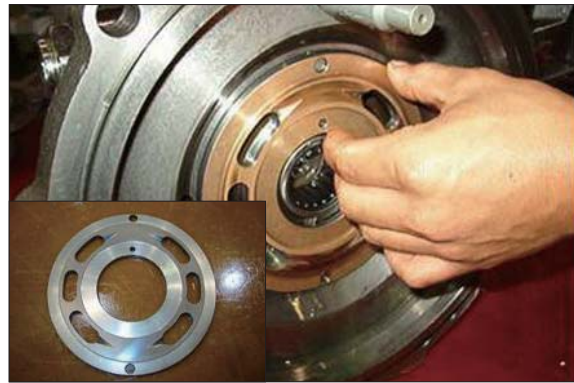

300072TM24A

300072TM24

- (6) After taking brake spring (32) and then bonding two pieces of M16 bolts to brake piston (29), disassemble it pulling it upward.
 ※ There are 10 pieces of brake spring.



300072TM25
 300072TM25A
 300072TM25B

- (7) First, rotate jig in disassembling and assembling up to 90°, then let a motor faced toward the horizon. then disassemble a cylinder and piston sub.



300072TM26

- (8) disassemble stopper L (18) and piston swash (17).
 ※ Piston swash : Use M5 bolt



300072TM27

(9) Disassemble swash plate (16).



300072TM28

(10) After put M12 into support (15), disassemble support.



300072TM29

(11) disassemble piston swash (10) and stopper (7).



300072TM30

(12) In order to making the turning axis (11) faced upward, put it way from shaft casing tapping the bottom of the turning axis with hammer, after rotating jig up to 90° in disassembling and assembling.

※ Try to deal with roller bearing (13) without any damage.



300072TM31

(13) Disassemble valve casing sub.

※ Try to deal with needle bearing (3) without any damage.

① Disassemble plowing road (60), automatic changeover spring (68), and automatic changeover spool (64).

※ Do not touch hexagon nut (63) for controlling the amount of an oil and lock screw (62).

If there is any abnormality on plowing spool and spring, exchange them to new ones.

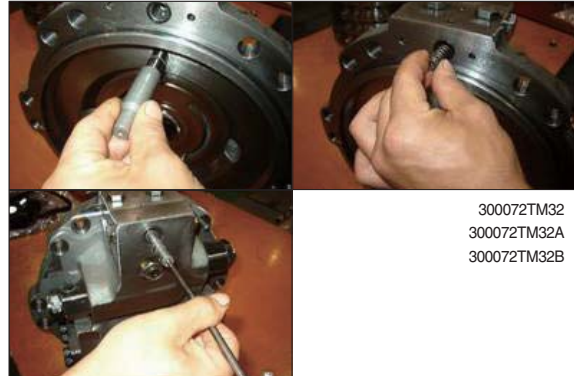

② After unloading hexagon socket bolts (49, 50) and taking caps (47,48) away, disassemble parts of counter balance valve (37~46).

※ In disassembling counter balance valve, be careful of figuring out the directions such as the right or the left of finger.

If there is any abnormality in spool spring check, exchange it to new one.



(14) Disassemble cylinder sub.

- ① Disassemble set plate (25) and piston (26) sub.



300072TM34

- ② Disassemble friction plate (27) and lee plate (28) in cylinder block (21).



300072TM35

- ③ Dismantle ball guide (24), spacer (23), and cylinder spring (22).

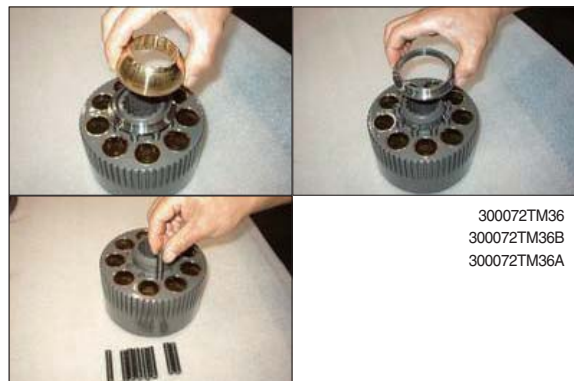

300072TM36
300072TM36B
300072TM36A

3) ASSEMBLING TRAVEL MOTOR

(1) Assemble the sub of a turning axis.

① After assembling bearing spacer (12) into a turning axis (11), have cylinder roller bearing (13) thermal-reacted.

a. In the thermal reaction of cylinder roller bearing, use an induction heating apparatus and adjust the temperature as about 100°C.

b. Deal moisturized copper part oil seal in a turning axis without any damage of it.



(2) Assemble ring stop (14) with a plier.

※ Be careful of the direction of ring stop.

(The direction of round is the side of bearing)



300072TM52

(3) Assemble valve casing sub.

① Bond seven pieces of plug (2) in valve casing (33) with standard torque.

② After taping plug with seal taper and spread rock tight, assemble it.

· Tightening torque : 7~11 kgf · m
(50.63~79.5 lbf · ft)



300072TM53

(4) Compress pin (36) into.

- ※ Using a hammer, make the height of pin 5mm from the a contact surface of valve plate.



300072TM54

(5) Assemble needle bearing (34).



300072TM55

(6) Assemble seat (51), ball (52), stopper (53), and hp plug (54) with O-ring (55), respectively.

- ① Be careful of the procedure and direction of assembling seat and stopper.

- Tightening torque : 37 kgf · m
(267.6 lbf · ft)



300072TM56

300072TM56A

(7) Assemble hp plug (54) set up with O-ring (55).

- 5sites
- Tightening torque : 37 kgf · m
(267.6 lbf · ft)



300072TM57

(8) Bond orifice screw (38) on the right and left side of spool c.b (37) with a standard torque.

- Tightening torque : 7 kgf · m (50.63 lbf · ft)

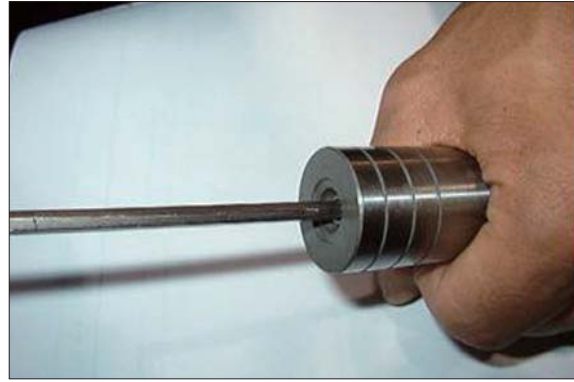

300072TM58

(9) Insert hold spool c.b (37) and damper check (39) into valve casing.

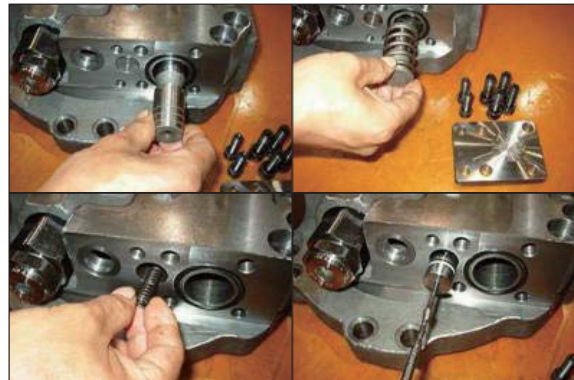

300072TM59
300072TM59B

300072TM59A
300072TM59C

(10) Bond cap R (47) and cap L (48) with hexagon socket bolts (49, 50).

① Remember not to exchange cap R, L each other in assembling.

Tightening torque

- M12 : 100 kgf · m (item 49)
- M10 : 67 kgf · m (item 50)



300072TM60

(11) After fastening with torque, insert automatic plowing spool (04), spring (68) and O-ring (69).

- Tightening torque : 75 kgf · m (542.4 lbf · ft)



300072TM61

300072TM61A

(12) Assemble swash road (60) inserted by O-ring (61).



300072TM62

(13) Insert O-ring (32) into valve casing.



300072TM63

(14) Bond drain plug (30) inserted by O-ring (31) with standard torque.

- Tightening torque : 100 kgf · m
(723.3 lbf · ft)



300072TM64

(15) Assemble cylinder sub.

① Assemble cylinder spring (22), spacer (23), and spherical surface bush (24) into cylinder (21).

Set the position of spline of spherical surface bush and cylinder.

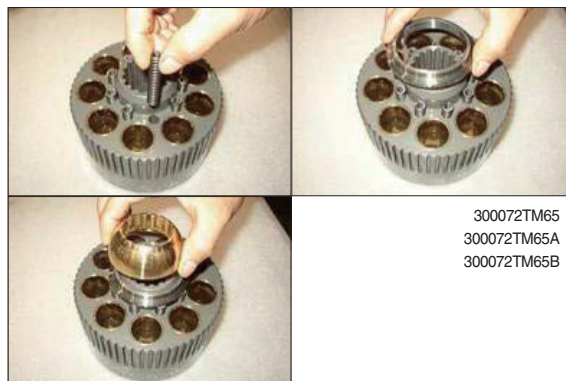

300072TM65
300072TM65A
300072TM65B

(16) Assemble friction plate (27) and separated plate (28) into cylinder.



300072TM66

(17) After insert piston shoe (26) into set plate (25), assemble it into cylinder.



300072TM67

300072TM67A

(18) Using jig, compress oil seal (73) into shaft casing (01).



300072TM68

(19) Assemble the body of a motor.

① Bond seven piece of plug (02) in shaft casing plug with standard torque.

a. After taping plug with seal taper and spread rock tight, assemble it.

· Tightening torque : 7~11 kgf · m
(50.63~79.5 lbf · ft)



300072TM69

300072TM69A

(20) Using a hammer and a handle, compress pin (5, 6).

① Pin(5) : Set the height as 10 mm from the contact surface of a plate supporter. - 2pieces.

Pin(6) : Set the height as 19 mm from the manufactured surface of shaft casing. - 4pieces.



300072TM70

300072TM70A

(21) Assemble sub of a turning axis.



300072TM71

(22) Assemble plate supporter (15) with M12 bolt.

※ Be careful of the direction of plate supporter driven.



300072TM72

(23) Assemble plate (16) into plate supporter.

① Spread grease in moisturized copper part of plate.

② Confirm the soft movement of plate.



300072TM73

(24) Assemble stopper L (36) combined by plowing piston (35) and O-ring (42).



(25) Rotating dismantling and assembling jig up to 90° make shaft from perpendicular to horizontal.

※ Be careful that plate is not segregated from plate supporter.



(26) Assemble cylinder sub.

※ Adjusting pin into holes of separated plate, assemble it.



(27) Rotating dismantling and assembling jig up to 90°, make the direction of shaft from the horizon to the perpendicular.



(28) Assemble piston ring (30), piston ring 252 (30) and 278 (31) into brake piston (29).



300072TM78

(29) Assemble brake piston into shaft casing.
※ Be careful of the direction of assembling brake piston.



300072TM79

(30) Assemble brake spring (32).
※ Quantity : Spring-10pieces, Holes-11pieces
※ Do not assemble on the top of brake piston.



300072TM80

(31) Insert O-ring (69), after fastening orifice screw (4) with standard torque.
· Quantity and size : (4) 2 pieces- \varnothing 1.0
(56) 1pieces- \varnothing 1.5
· Tightening torque : 7 kgf · m (50.63 lbf · ft)



300072TM81

(32)After inserting valve plate (67) into valve casing, bond it into shaft casing with hexagon socket bolt (70).

- ① Spread grease on the back side of valve plate, in order for valve plate to be adhered well.
- ② Use a crane in assembling it into valve plate shaft casing.
- ③ Set holes, $\varnothing 5$, of valve plate heading toward the port of the inlet and outlet of valve casing.
- ④ Spread grease in the side of plowing spool of plowing spring in order that plowing spring can not be detached.
 - Tightening torque : 240 kgf · m
(1736 lbf · ft)
 - Tightening torque : 180 ± 10 kgf · m
(1302 ± 72.3 lbf · ft)



300072TM82

(33)Bond relief valve (57) with standard torque.



300072TM83

(34)Unloosen four pieces of bolts (M20×50L) fixing a motor and remove the motor away from jig.



300072TM84

3. DISASSEMBLING REDUCTION UNIT

1) Preparation for disassembling

(1) The reduction units removed from excavator are usually covered with mud. Wash outside of propelling unit and dry it.

(2) Locate reducer in order for drain port to be at the lowest level loosen taper screw plug of drain port, and drain oil from reduction gear.

※ While oil is still hot, inside of the unit may be pressurized.

▲ Take care of the hot oil gushing out of the unit when loosening the plug.

(3) Mark for mating

Put marks on each mating parts when disassembling so as to reassemble correctly as before.

2) Setting reduction unit (or whole propelling unit) on work stand for disassembling

(1) Remove hexagon socket head bolts (M10, 19) at 3 places from cover (17) almost equally each other, and then install eye bolts (M10).

Lift up the unit using them and place it on work stand with cover upward.

※ Take great care not to pinch your hand between parts while disassembling nor let fall parts on your foot while lifting them.

3) Removing cover

(1) Remove the rest of hexagon socket head bolts (M10, 19) that secure ring gear. Loosen all the socket bolts and then, disassemble cover.

(2) As the cover (17) is adhered to ring gear (14), disassemble ring gear (14) and cover (17) by lightly hammering slantwise upward using sharpened punch inserted between the cover and ring gear.



300078RD01

4) Removing NO.1 carrier sub assy

(1) Remove No.1 sun gear

- ※ Be sure to maintain it vertical with the ground when disassembling No.1 sun gear.



300078RD02

- (2) Screw three eye bolt (M10, 15) in No.1 carrier and lift up and remove No.1 carrier assy.



300078RD03

5) Removing No. 2 carrier sub assy

(1) Remove No.2 sun gear

- ※ Be sure to maintain it vertical with the ground when disassembling No.2 sun gear.



300078RD04

- (2) Screw three M10 eye bolt in No.2 carrier and lift up and remove No.2 carrier assy.



300078RD05

6) Removing ring gear

- (1) Remove hexagon socket head bolts (M14, 15) that secure ring gear and housing.



300078RD06

- (2) As the ring gear (14) is adhered to housing (3), disassemble ring gear (14) and housing (3) by lightly hammering slantwise upward using sharpen punch inserted between the ring gear and housing.

※ Carefully disassembling ring gear not to make scratch on it.

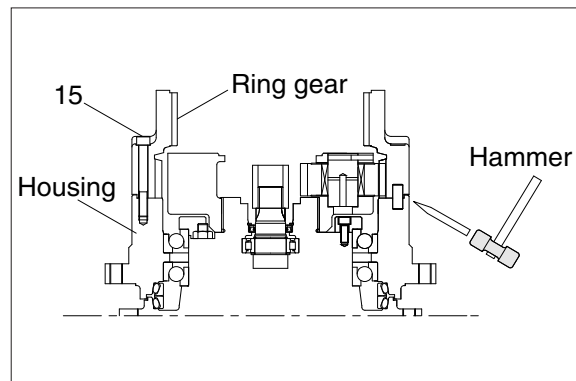

2907A8RD01

- (3) Screw three eye bolt (M10) in ring gear and lift up and remove it.

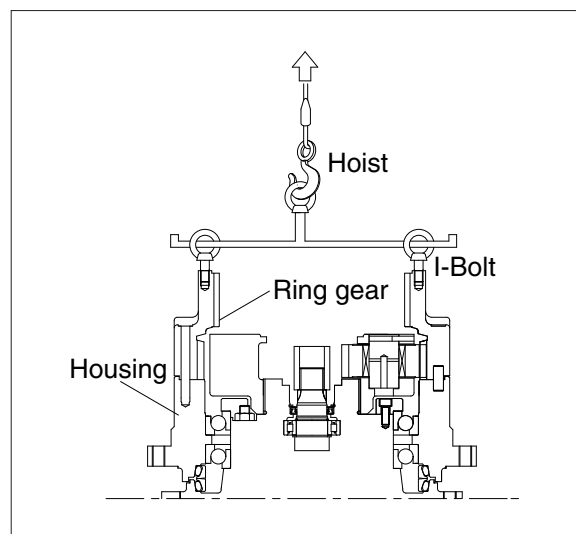

2907A8RD02

7) Remove No.3 carrier sub assy

(1) Removing No.3 sun gear

※ Be sure to maintain it vertical with the ground when disassembling No.3 sun gear.



300078RD09

(2) Screw three eye bolt(M10) in No.3 carrier and lift up and remove No.3 carrier assy.

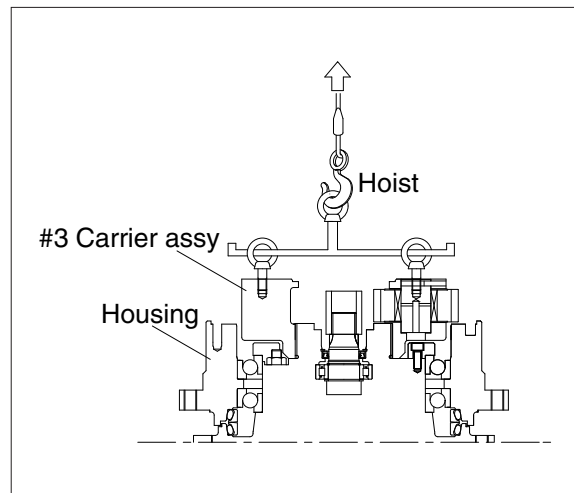

2907A8RD03

8) Remove coupling

(1) Remove coupling

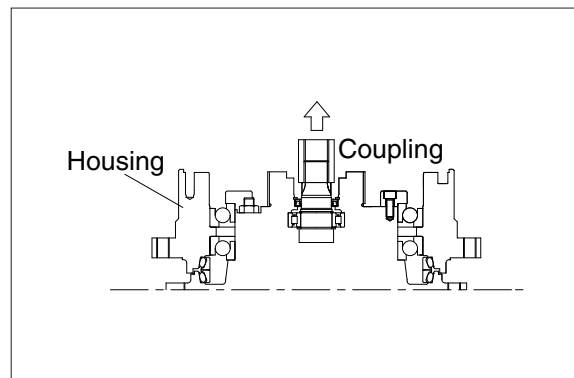

2907A8RD04

9) Remove motor ring

- (1) Remove motor ring using hand.



300078RD12

10) Removing retainer & shim

- (1) Remove hexagon socket (M12) head bolts that retainer and motor.
- (2) Remove retainer & shim.



300078RD13

11) Removing housing sub assy

- (1) Screw eye bolt (M14) in housing and lift up housing assembly including angular bearing and floating seal.

12) Removing floating seal

- (1) Lift up a piece of floating seal of motor side.

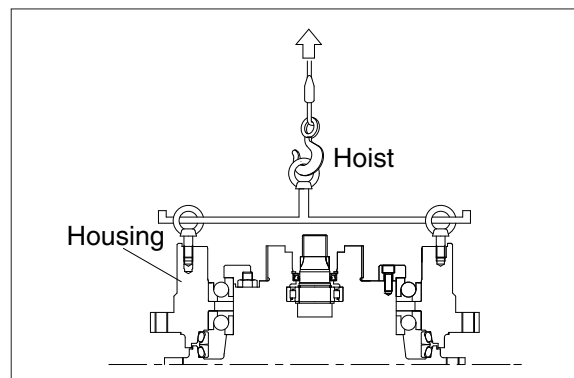

2907A8RD05

13) Disassembling housing assembly

- (1) After turning housing, lift up a piece of floating seal from housing and then remove it.
- ※ Don't disassemble angular bearing.



300078RD15

14) Disassembling No.1 carrier

- (1) Remove thrust ring (16) from carrier.
- (2) Knock spring pin (89-6) fully into No.1 pin (90-5).
- (3) Remove planetary, thrust washer, No.1 pin, bearing from carrier.

15) Disassembling No.2,3 carrier

- (1) Disassemble (14) carriers, using the same method for No.1 carrier assembly.



300078RD15

6. ASSEMBLING REDUCTION GEAR

- General precautions

Clean every part by kerosene and dry them by air blow.

Surfaces to be applied by locktite must be decreased by solvent.

Check every part for any abnormal.

Each hexagon socket head bolt should be used with locktite No. 242 applied on its threads.

Apply gear oil slightly on each part before assembling.

Take great care not to pinch your hand between parts or tools while assembling nor let fall parts on your foot while lifting them.

Inspection before reassembling

Thrust washer

- Check if there are seizure, abnormal wear or uneven wear.
- Check if wear is over the allowable limit.

Gears

- Check if there are pitting or seizure on the tooth surface.
- Check if there are cracks on the root of tooth by die check.

Bearings

- Rotate by hand to see if there are something unusual such as noise or uneven rotation.

Floating seal

- Check flaw or score on sliding surface or on O-rings.

1) Assembling No.1 carrier

- (1) Put No.1 carrier (90-1) on a flat place.
- (2) Install No.1 needle bearing (90-3) into No.1 planetary gear (90-2), put 2 ea of No.1 thrust washer (90-4) on both sides of bearing, and then install it into carrier.
- (3) Install No.1 pin (90-5) into No.1 carrier where the holes for No.1 pin (90-5) are to be in line with those of No.1 carrier, and then, install spring pins into the holes.
- (4) Caulk carrier holes as shown on the picture.
- (5) Assembly ring thrust (96) into carrier.

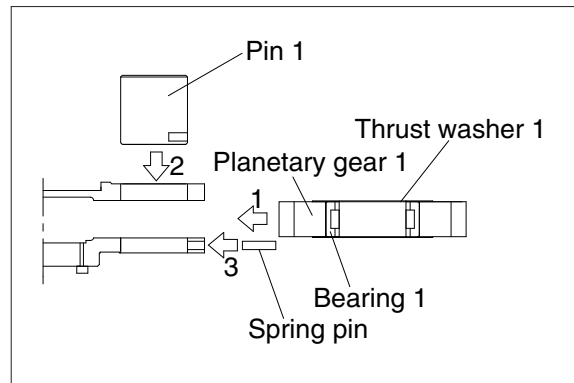

2907A8RD06



300078RD15

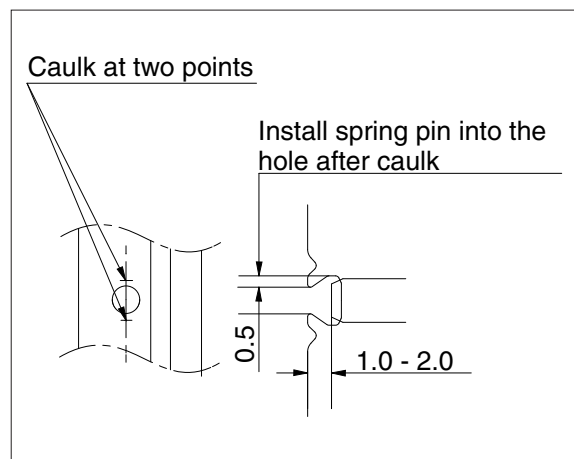

2907A8RD19

2) Assembling No.2 carrier

- (1) Make No.2 planetary gear (89-2) vertical, assemble 8-9 ea of No.2 needle (89-3), and then, assemble the remaining No.2 needle by use of the assembly jig for No.2 pin (89-5).
- (2) Remove out the assembly jig for No.2 pin and assemble 2 ea of No.2 thrust washer (89-4) into No.2 carrier (89-1).
- (3) Insert No.2 pin (89-5) into carrier where the holes of No.2 pin (89-5) are in line with those of carrier.
- (4) Hammer spring pin (89-6) to insert into carrier hole and No.2 pin hole, and then, caulk. Assemble 2 sets using the same method.
- (5) Assemble ring thrust (98) into carrier.

3) Assembling No.3 carrier

- (1) Assemble 4 sets, using the same method for assembly of No.2 carrier.

4) Installing floating seal

- (1) Assemble floating seal into motor by use of pressing jig.
- (2) Grease the contact parts for floating seal which is assembled into motor.

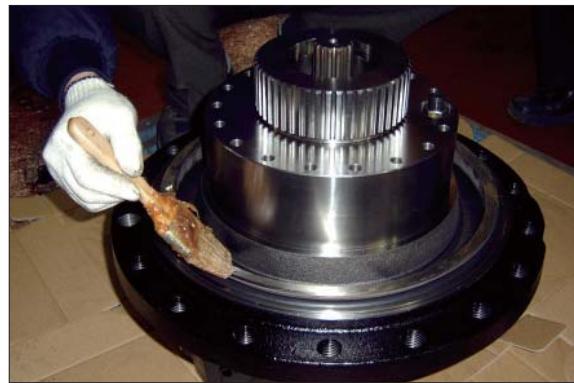
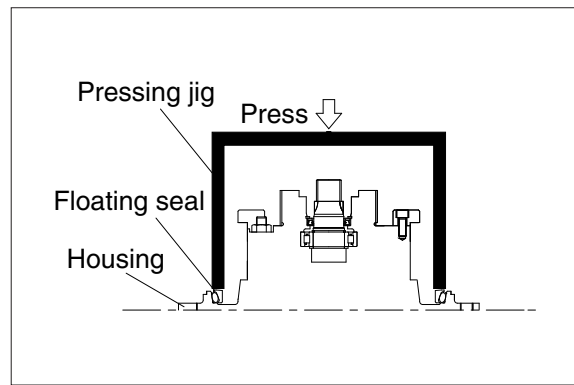
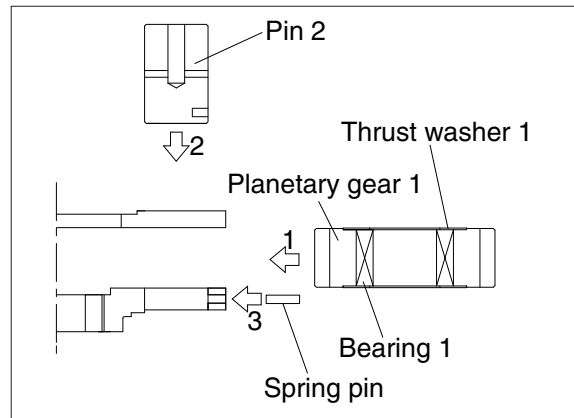
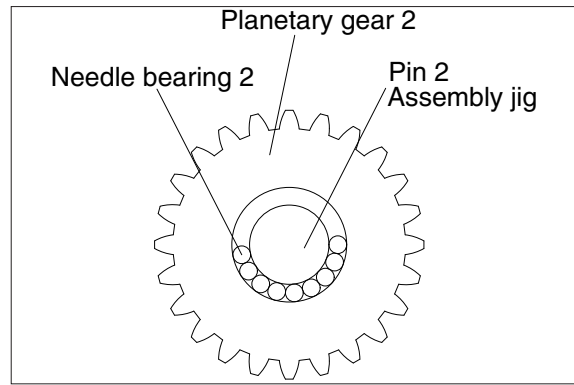

5) Assembling housing

- (1) Heat housing at 60~70 °C while clearing it out and then, assemble bearing.
 - (2) Assemble floating seal into housing by use of pressing jig as shown on the picture.
- ※ Be sure to maintain it vertical with the ground when assembling bearing and floating seal.

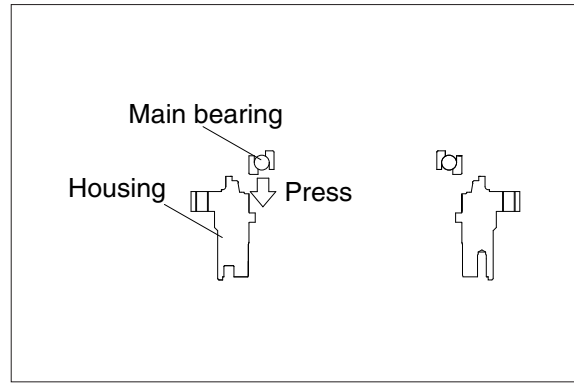

2907A8RD10

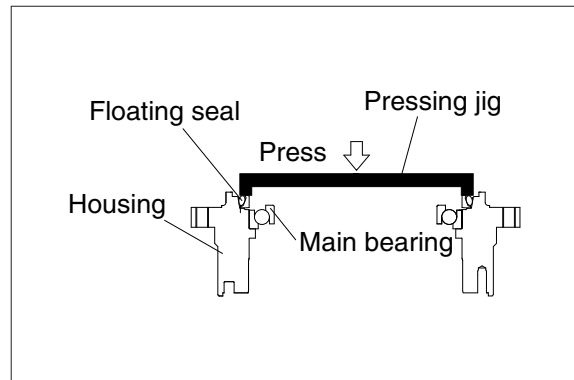

2907A8RD11

6) Installing housing assembly

- (1) Install 2 ea of eye bolt (M14) into housing assembly.
 - (2) Assemble housing into motor by use of hoist and eye bolt.
- ※ Be sure to tighten eye bolt deep enough.

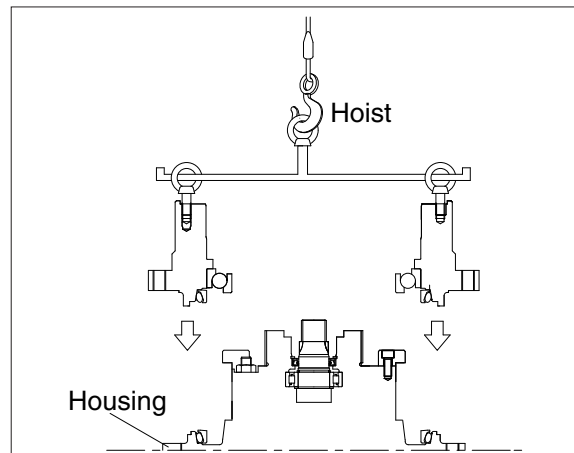

2907A8RD12

7) Installing main bearing

- (1) Heat main bearing at 60~70°C and then, install.
- ※ Be sure to maintain it vertical with the ground when assembling bearing.

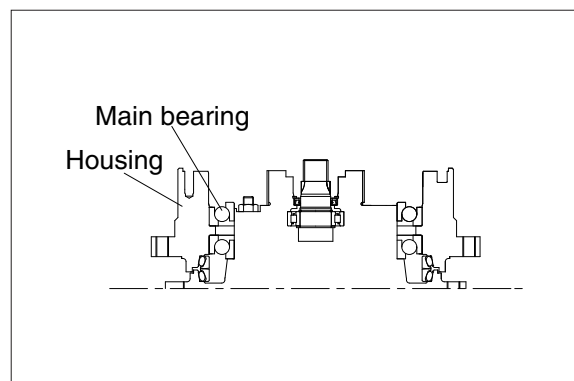

2907A8RD13

8) Installing retainer (86) and shim (85)

- (1) Measure clearance between main bearing and retainer by use of jig to decide the thickness of shim and select and appropriate shim, and then, assemble retainer.
- (2) Apply locktite (#242) on hexagon socket head bolt (M12), and then, bolt.

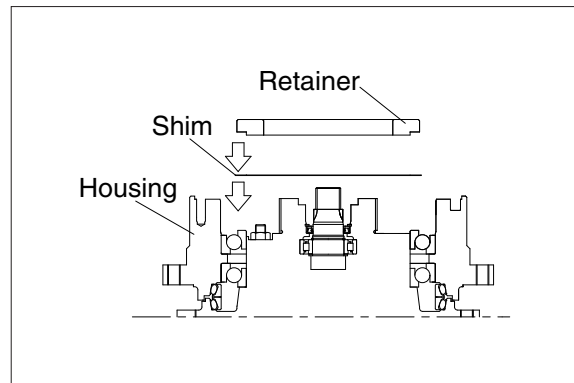

2907A8RD14



300078RD13

9) Installing motor ring

- (1) Insert motor ring into motor to install.

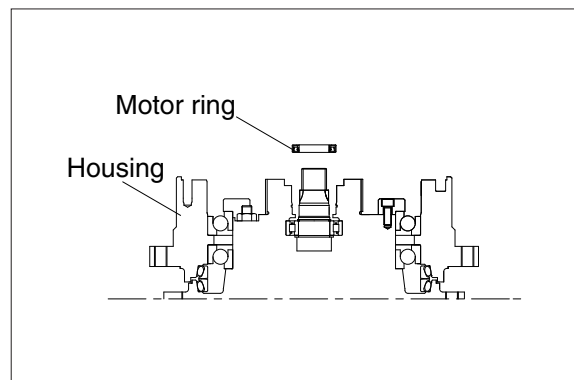

2907A8RD15

10) Installing coupling

- (1) Install coupling on spline of the motor.

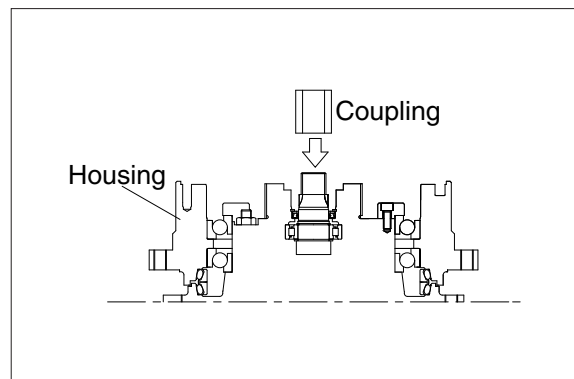

2907A8RD16

11) Installing No.3 carrier sub assy

- (1) Install eye bolt (M10) on No.3 carrier assembly.
 - (2) Lift No.3 carrier assembly and then, assemble it into reducer.
- ※ Match it vertical with the spline of the motor and the, slowly lower.

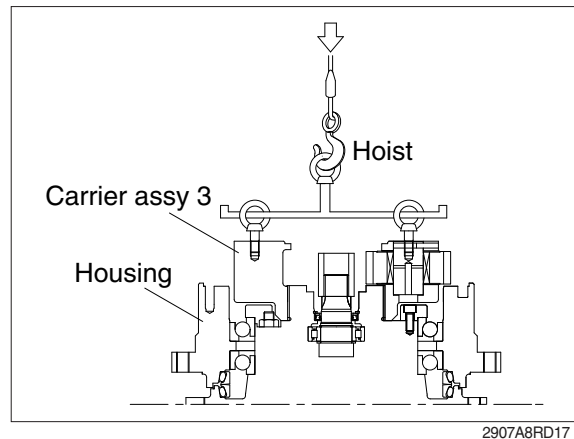

12) Installing ring gear

- (1) Apply three bond #1104 (Locktite #515) on housing for ring gear without gap.
- (2) Insert lock pin into housing hole.
- (3) Install eye bolt (M12) on the tap for cover of ring gear.
- (4) Lift ring gear and then, assemble into housing.
- (5) Apply locktite to hexagon socket bolt (M14) and then, bolt, having appropriate torque.

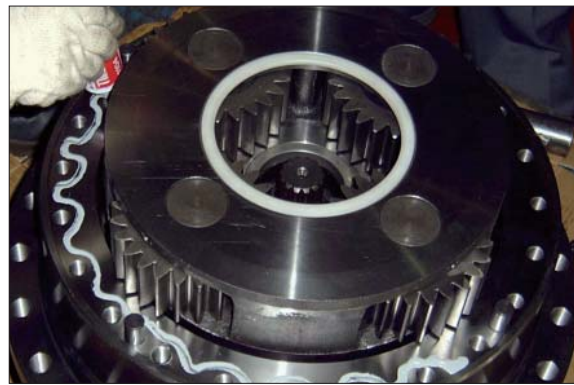

13) Installing No.3 sun gear (88-7)

- (1) Install snap ring (88-8) in No.3 sun gear (88-7) by use if snap ring flier.
- (2) Install No.3 sun gear on the spline of No.3 carrier, matching teeth of them.

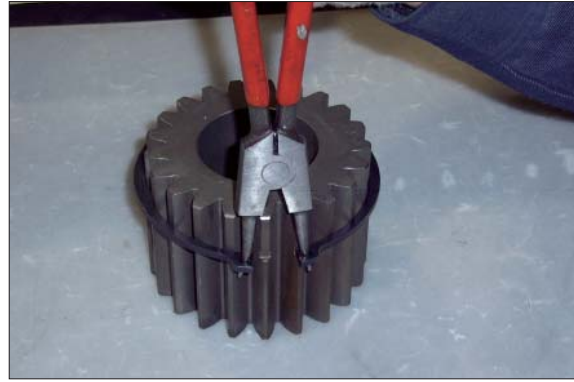

300078RD32



300078RD09

14) Installing No.2 carrier sub assy

- (1) Install eye bolt(M10) on No.2 carrier assembly.
- (2) Lift No.2 carrier assembly and then, slowly put it down on ring gear.
- (3) Rotate planetary gear by hands and install in ring gear.



300078RD05

15) Installing No.2 sun gear (89-7)

- (1) Install snap ring (89-8) on No.2 sun gear (89-7) by use of snap ring flier.
- (2) Install No.2 sun gear on the spline of No.2 carrier and No.2 planetary gear, matching teeth of them.

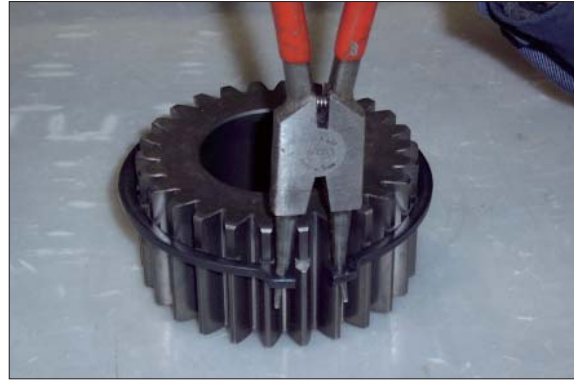

300078RD33



300078RD04

16) Installing No.1 carrier sub assy

- (1) Install eye bolt (M10) on No.1 carrier assembly.
- (2) Lift No.1 carrier assembly and then, put it down on ring gear slowly.
- (3) Rotate planetary gear by hands to install on ring gear, matching their teeth.



300078RD03

17) Installing No.1 sun gear (91)

- (1) Put down No.1 sun gear on No.1 carrier, maintaining it vertical with spline of coupling.
- (2) Install No.1 sun gear on No.1 planetary gear, matching their teeth.



300078RD02

18) Installing cover (97)

- (1) Beat pad with plastic hammer, and press it into the center of cover.
- (2) Apply three bond #104 (locktite #515) on the ring gear for without gap.
- (3) Put cover on ring gear, apply locktite (#242) in hexagon socket head bolt (M10), and then, bolt.
- (4) Fill gear oil (8L) into drain port.
- (5) Apply sealing tape (teflon) on PT3/4 plug and then, bolt.

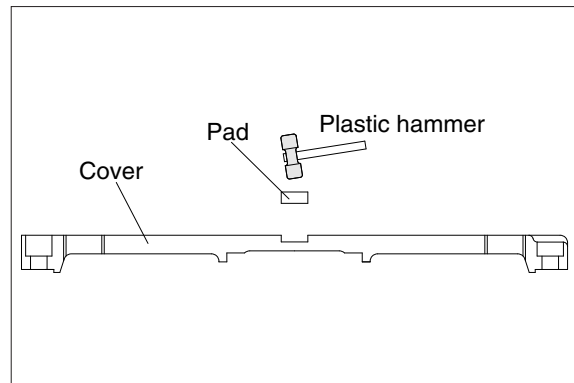

2908ARD18



300078RD35

GROUP 6 TRAVEL DEVICE (TYPE 3)

1. REMOVAL AND INSTALL

1) REMOVAL

- (1) Swing the work equipment 90° and lower it completely to the ground.
- (2) Operate the control levers and pedals several times to release the remaining pressure in the hydraulic piping.
- (3) Loosen the breather slowly to release the pressure inside the hydraulic tank.

▲ Escaping fluid under pressure can penetrate the skin causing serious injury.

※ When pipes and hoses are disconnected, the oil inside the piping will flow out, so catch it in oil pan.

- (4) Remove the track shoe assembly.
For details, see **removal of track shoe assembly**.
- (5) Remove the cover.
- (6) Remove the hoses.
※ Fit blind plugs to the disconnected hoses.
- (7) Remove the bolts and the sprocket.
- (8) Sling travel device assembly (1).
- (9) Remove the mounting bolts (2), then remove the travel device assembly.
· Weight : 305 kg (670 lb)

2) INSTALL

- (1) Carry out installation in the reverse order to removal.
- (2) Bleed the air from the travel motor.
 - ① Remove the air vent plug.
 - ② Pour in hydraulic oil until it overflows from the port.
 - ③ Tighten plug lightly.
 - ④ Start the engine, run at low idling, and check oil come out from plug.
 - ⑤ Tighten plug fully.
- (3) Confirm the hydraulic oil level and check the hydraulic oil leak or not.

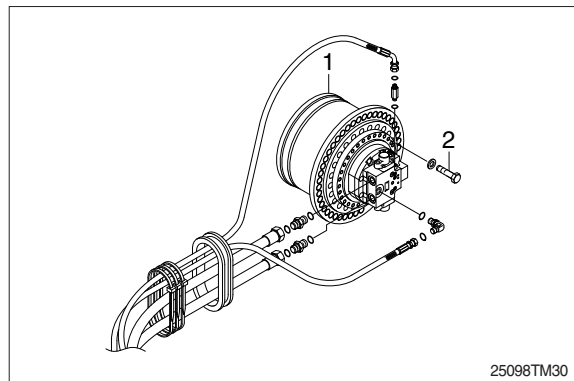

2. TRAVEL MOTOR

1) STRUCTURE

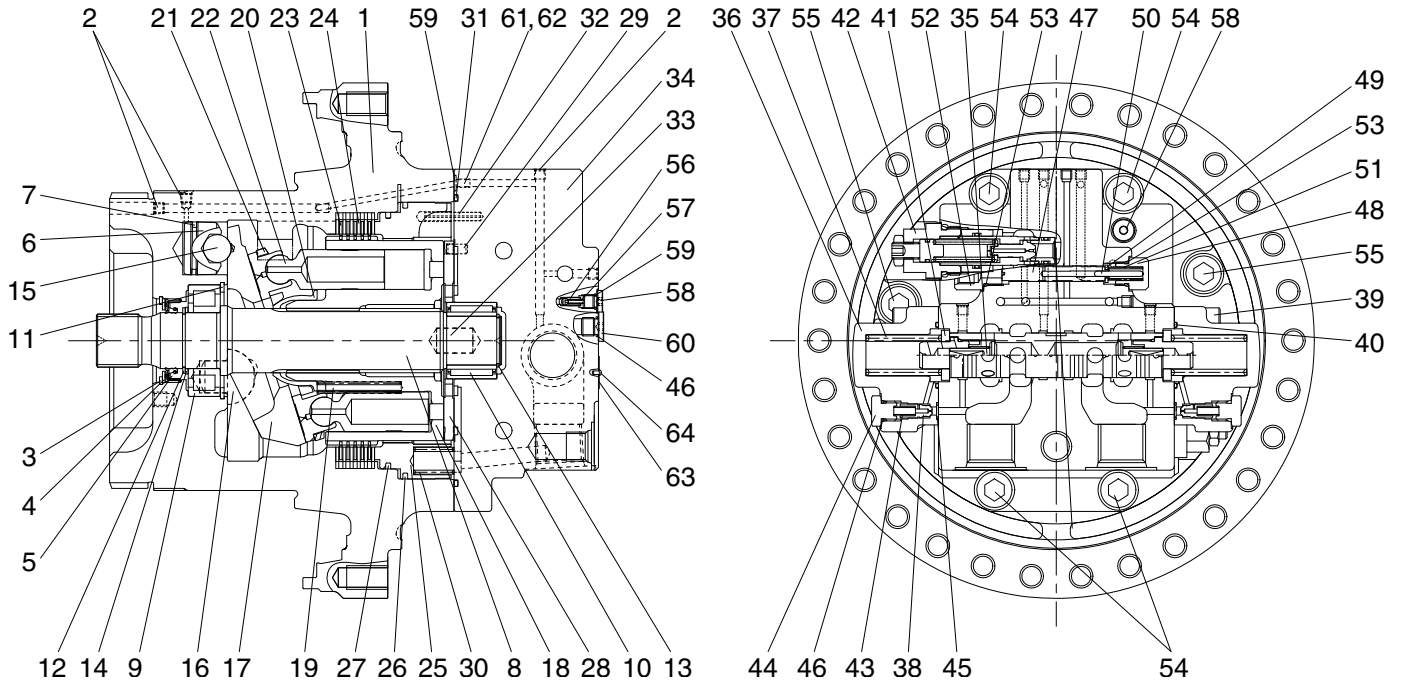

1	Casing	23	Friction plate	44	Plug
2	Plug	24	Separated plate	45	O-ring
3	Oil seal	25	Parking piston	46	O-ring
4	Thrust plate	26	D-ring	47	Spool
5	Snap ring	27	D-ring	48	Plug
6	Piston	28	Valve plate	49	Seat spring
7	Piston seal	29	Parallel pin	50	Parallel pin
8	Shaft	30	Spring	51	Spring
9	Cylinder roller bearing	31	O-ring	52	Connector
10	Needle bearing	32	Spring pin	53	O-ring
11	Snap ring	33	Parallel pin	54	Hexagon socket head bolt
12	Snap ring	34	Rear cover	55	Hexagon socket head bolt
13	Snap ring	35	Main spool assy	56	Check valve
14	Thrust plate	36	Cover	57	Spring
15	Steel ball	37	Spring	58	Plug
16	Pivot	38	Restrictor	59	O-ring
17	Swash plate	39	Hexagon socket head bolt	60	Plug
18	Cylinder block	40	O-ring	61	Restrictor
19	Spring	41	Seat spring	62	Restrictor
20	Ball guide	42	Relief valve assy	63	Name plate
21	Retainer plate	43	Spring	64	Rivet
22	Piston assy				

25092TM21

2) TOOLS AND TIGHTENING TORQUE

(1) Tools

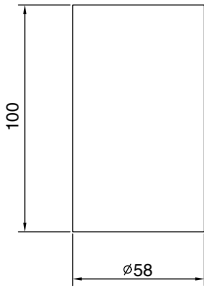
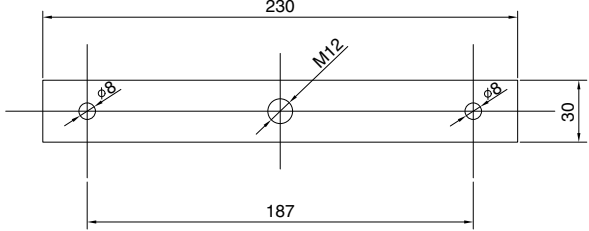
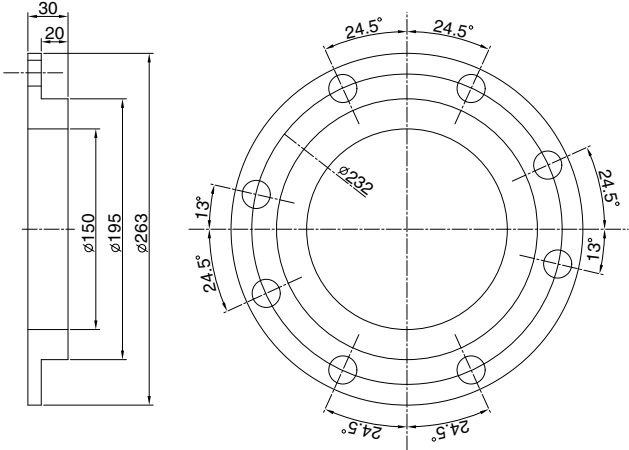
Tool name	Remark
Hexagon wrench	Width across flat 5, 6, 8, 10, 14 mm
Snap ring prier	For shaft $\varnothing 60\sim 80$ mm
Snap ring prier	For bore $\varnothing 32\sim 58$ mm
Plastic hammer	1 piece
Screw driver	Minus (-), medium size, 2 pieces
Torque wrench	10 kgf·m (72.3 lbf·ft), 33 kgf·m (238.6 lbf·ft), 45 kgf·m (325.4 lbf·ft)
Gig for inserting oil seal	 <p style="text-align: right;">25098TM31</p>
Gig for inserting parking piston (M10×100 bolt 2EA, M12×100 bolt 1EA)	 <p style="text-align: right;">25098TM32</p>
Gig for pulling out brake piston	 <p style="text-align: right;">25098TM33</p>

(2) Tightening torque

Item	Name	Size	Torque	
			kgf · m	lbf · ft
2	Plug	NPTF 1/16	1.1±0.1	7.9±0.72
39	Hexagon socket head bolt	M12	1.0±1.0	72.3±7.2
42	Relief valve	1 5/16	34±3.4	246±24.6
44	Plug	PF 1/4	2.8±0.3	20.3±2.17
48	Plug	PF 3/8	5.5±0.5	39.8±3.6
52	Connector	PF 3/8	5.5±0.5	39.8±3.6
54	Hexagon socket head bolt	M18	38±3.8	275±27.5
55	Hexagon socket head bolt	M18	38±3.8	275±27.5
58	Plug	PF 1/8	1.5±0.1	10.8±0.72
60	Plug	PF 1/4	3±0.3	21.7±2.17

3. DISASSEMBLING

1) GENERAL INSTRUCTIONS

- ▲ Combustibles such as white kerosene are used for washing parts.**
These combustibles are easily ignited, and could result in fire or injury.
Be very careful when using.
 - ▲ Internal parts are coated with hydraulic fluid during disassembling and are slippery.**
If a part slips out of your hand and falls, it could result in bodily injury or could damage the park.
Be very careful when handling.
- (1) Generally, hydraulic equipment is precisely manufactured and clearances between each parts are very narrow. Therefore, disassembling and assembling works should be performed on the clean place where dusts hardly gather. Tools and kerosene to wash parts should also be clean and handled with great care.
 - (2) When motor is removed from the host machine, wash around the ports sufficiently and put the plugs so that no dust and/or water may invade. Take off these plugs just before the piping works when re-attach it to the host machine.
 - (3) Before disassembling, review the sectional drawing and prepare the required parts, depending on the purpose and the range of disassembling.
Seals, O-rings, etc., if once disassembled, are not reusable.
There are some parts that should be replaced as a subassembly.
Consult with the parts manual in advance.
 - (4) The piston can be inserted to whichever cylinder block for the initial assembling.
However, their combination should not be changed if they are once used. To reuse them, put the matching mark on both pistons and cylinder block before disassembling.
- ▲ Take great care not to pinch your hand between parts while disassembling nor let fall parts on your foot while lifting them.**

2) DISASSEMBLING TRAVEL MOTOR

- (1) Disassemble the wrench bolt (39) to tighten the spool cover (36) and rear cover (34) by using the L-wrench or impact wrench and then disassemble the spring (37), spring seat (41) and main spool assy (35) in order.

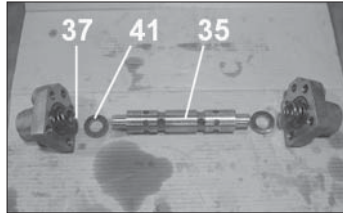

25098TM034

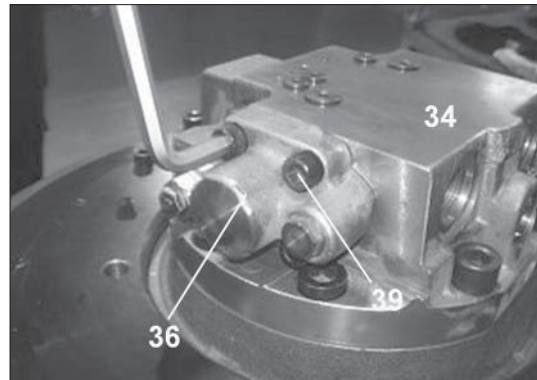

25098TM035

- (2) Disassemble the wrench bolt (54, 55) to tighten the casing (1) and rear cover (34) by using the L-wrench or impact wrench.

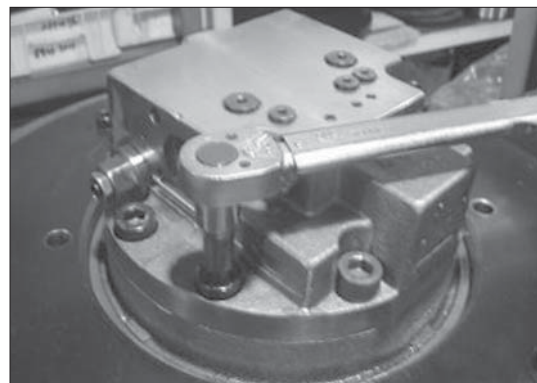

25098TM036

- (3) Separate the casing (1) and rear cover (34).

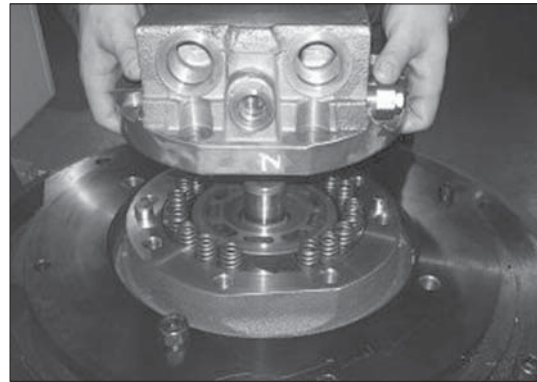

25098TM037

- (4) Disassemble the brake spring (30, 18EA) from the piston.

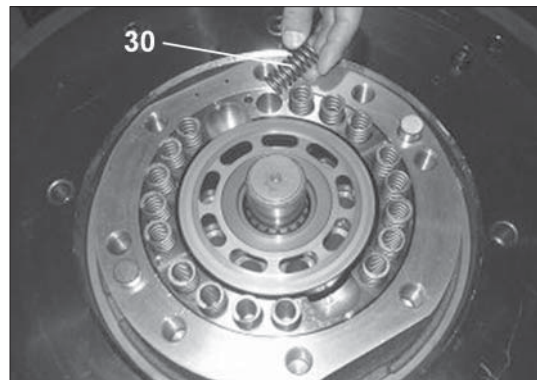

25098TM118

- (5) Disassemble the parking piston (25) by using the jig for disassembling parking piston.

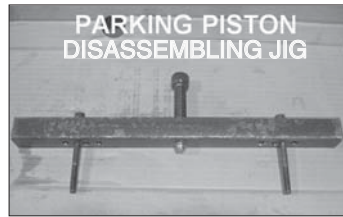

25098TM039

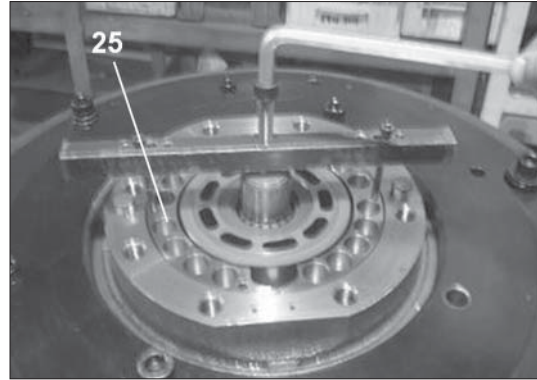

25098TM040

- (6) Disassemble the separate plate (24, 5EA) and friction plate (23, 4EA) from the casing.

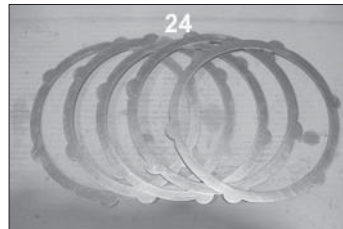

25098TM041

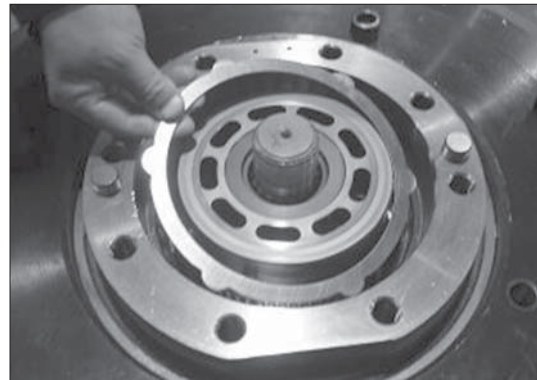

25098TM042

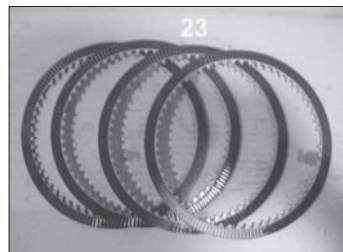

25098TM043

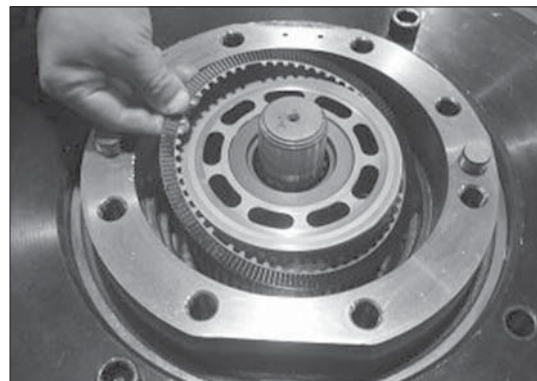

25098TM044

- (7) Turn the casing (1) horizontal by using the assemble truck and disassemble the cylinder block kit form the casing (1).

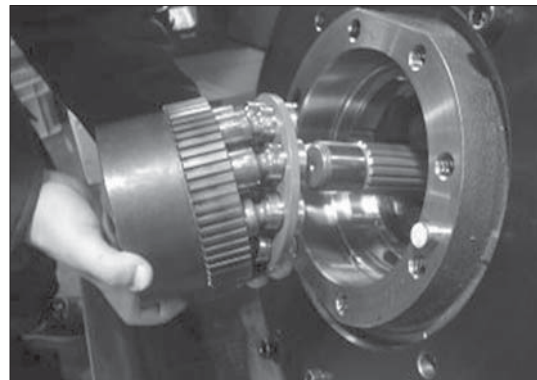

25098TM045

(8) Disassemble the cylinder block (18), retainer plate (21), piston assy (22), ball guide (20) and spring (19) from the cylinder block kit.



25098TM046

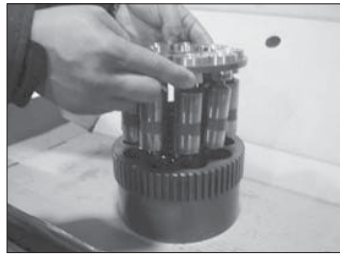

25098TM047

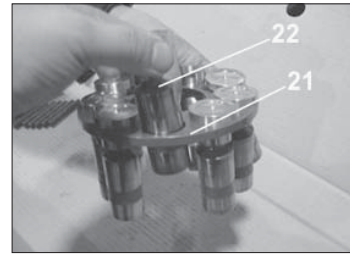

25098TM048

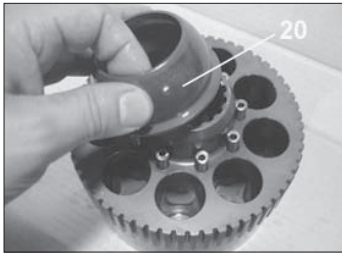

25098TM049

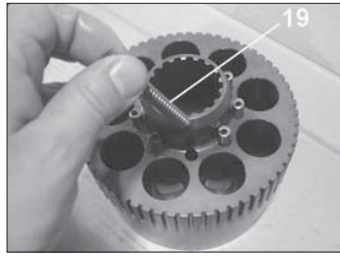

25098TM050

(9) Disassemble the swash plate (17) from the casing.



25098TM051

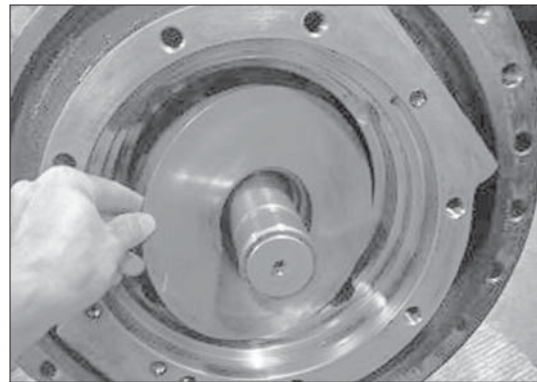

25098TM052

(10) Disassemble the steel ball (15) and swash piston (6) from the casing.

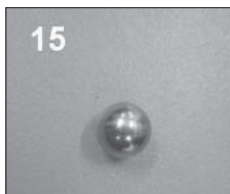

25098TM053

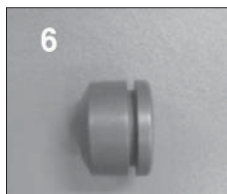

25098TM054



25098TM055

(11) Disassemble the pivot (16, 2EA) from the casing.

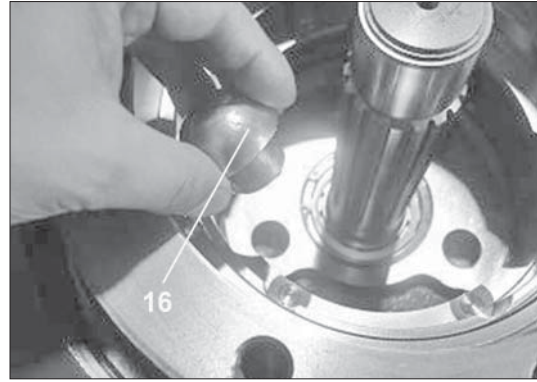

25098TM056

(12) Disassemble the snap ring (11) from the shaft (8) with the pryer for retaining ring.

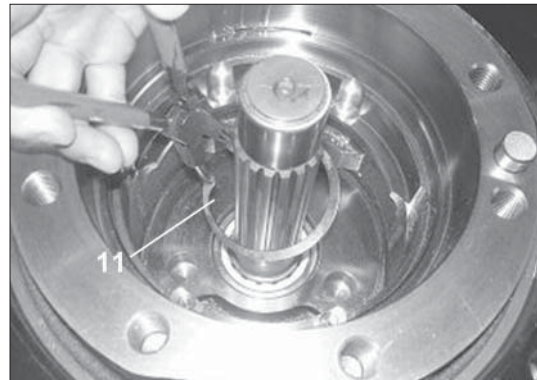

25098TM057

(13) Disassemble the shaft (8) from the casing (1).

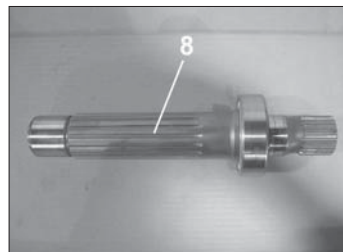

25098TM058

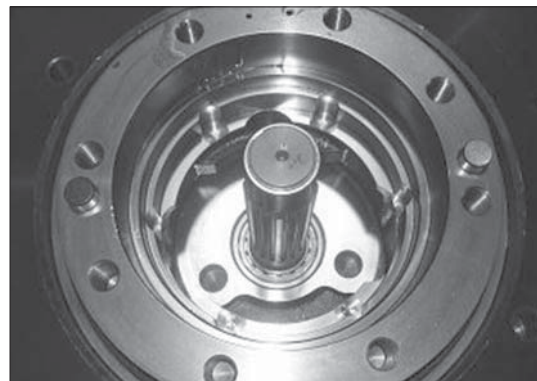

25098TM059

(14) Disassemble the snap ring (5) from the casing (1) with the pryer for retaining ring.

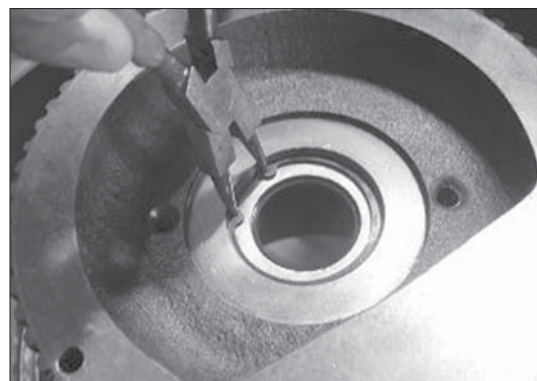

25098TM060

(15) Disassemble the thrust plate (4) from the casing (1).

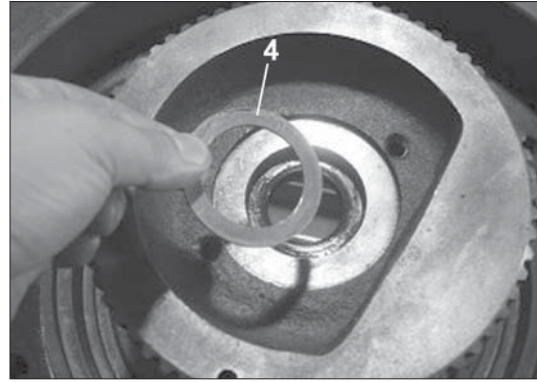

25098TM061

(16) Disassemble the oil seal (3) from the casing (1) with suitable tool.



25098TM062

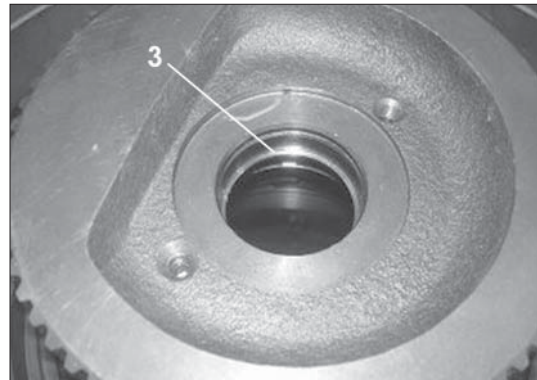

25098TM063

(17) Disassemble the O-ring (31) from the casing (1).

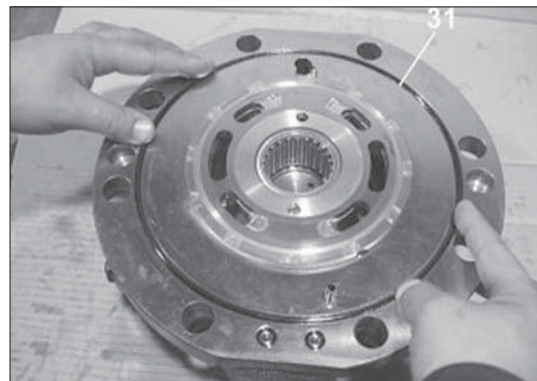

25098TM064

(18) Disassemble the valve plate (28) from the casing (1).

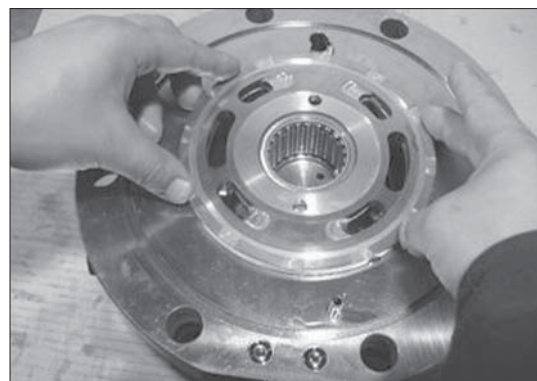

25098TM065

(19) Disassemble the relief valve (42, 2EA) from the rear cover (34) by using the torque wrench.

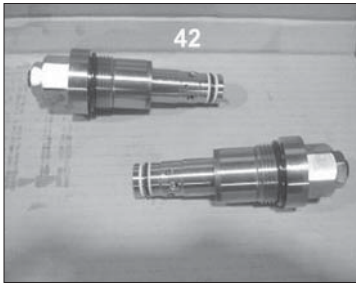

25098TM066

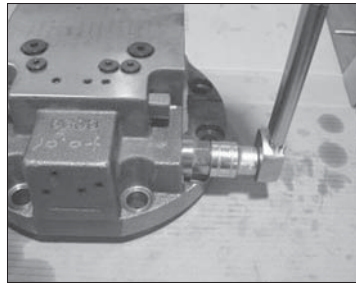

25098TM067

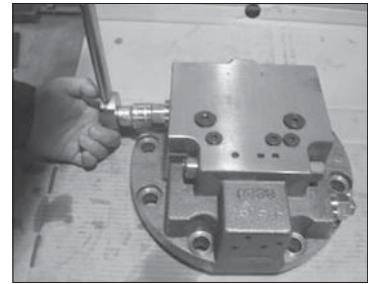

25098TM068

(20) Disassemble both side of the plug (48) and connector (52) from the rear cover (34) by using the torque wrench and then disassemble the spring (51), spring seat (49), parallel pin (50) and spool (47) in order.

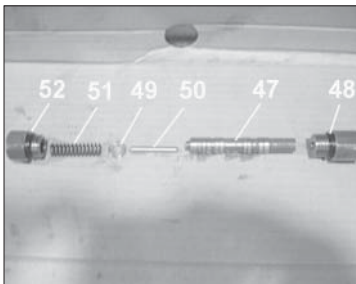

25098TM069

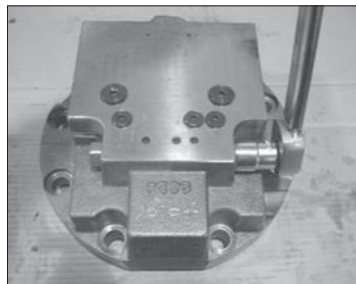

25098TM070

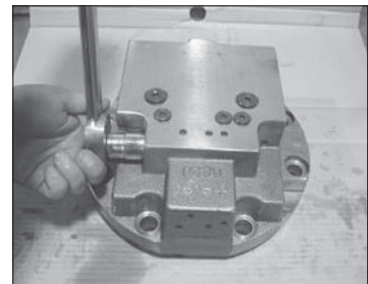

25098TM071

(21) Disassemble the plug (60) from the rear cover.

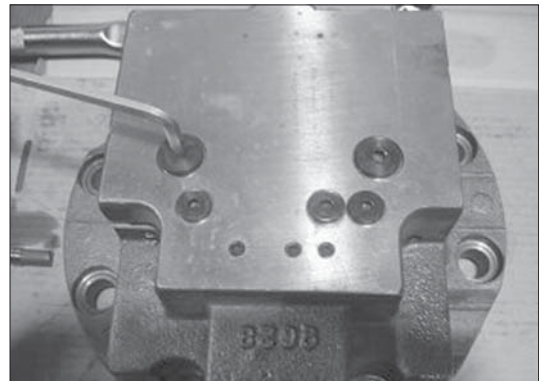

25098TM072

(22) Disassemble the plug (58) and then disassemble the spring (57) and check valve (56) from the rear cover in order.

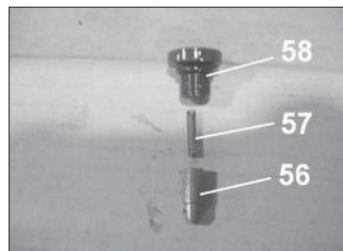

25098TM073

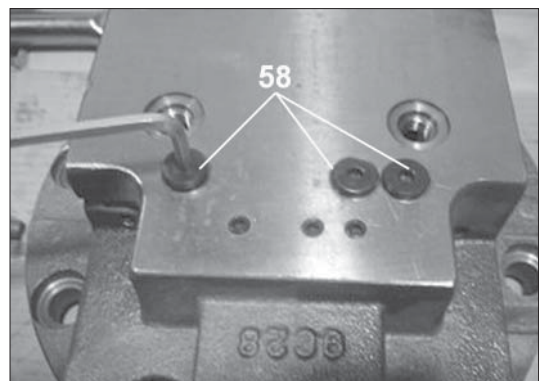

25098TM074

4. REASSEMBLING

1) ASSEMBLING MOTOR

- REAR COVER ASSY

- (1) Assemble the check valve (56) and the spring (57) to the rear cover and then tighten the plug (60) by using the L-wrench.

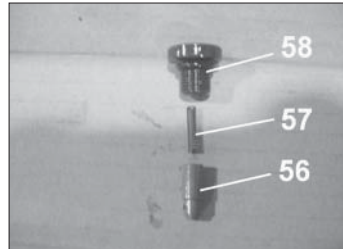

25098TM075

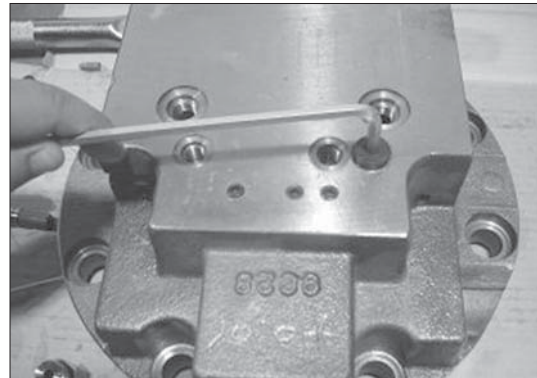

25098TM076

- (2) Apply the loctite #242 on the NPTF 1/16 plug (2, 12EA) and tighten it.

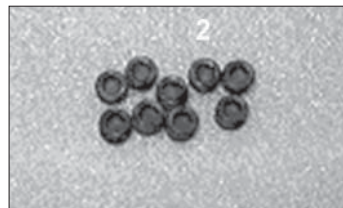

25098TM077

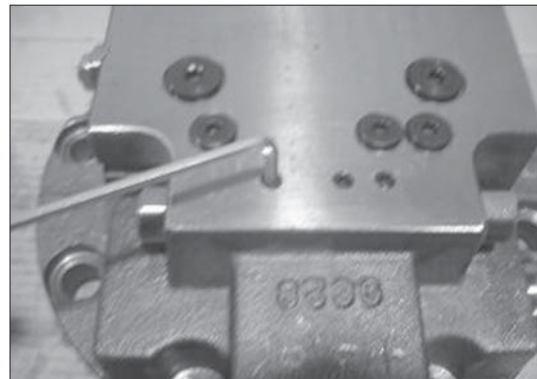

25098TM078

- (3) Assemble the spool (47), parallel pin (50), spring seat (49) and spring (51) into the rear cover (34) and tighten both side of the plug (48) and connector (52) into the rear cover (34).

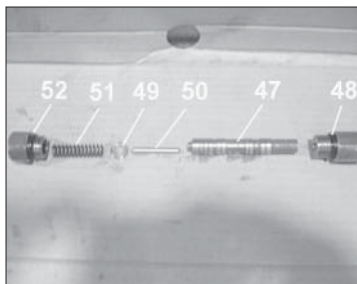

25098TM079

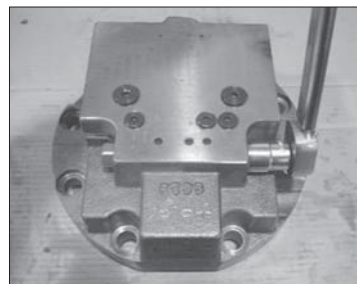

25098TM080

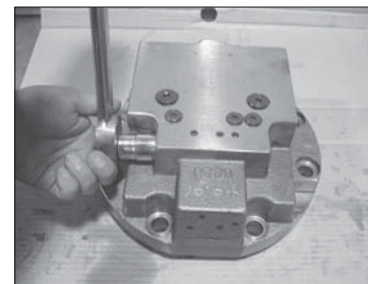

25098TM081

- (4) Assemble the relief valve (42, 2EA) into rear cover (34).

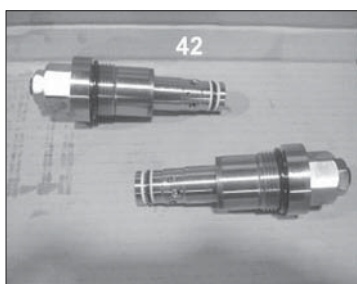

25098TM082

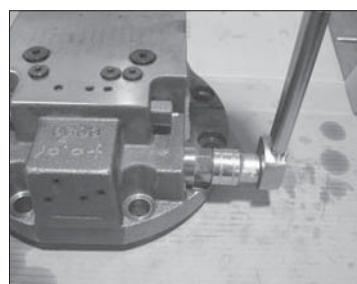

25098TM083

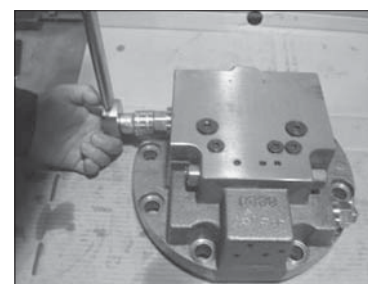

25098TM084

- (5) Tight fit the needle bearing (10) into rear cover (34) by using pressing jig.

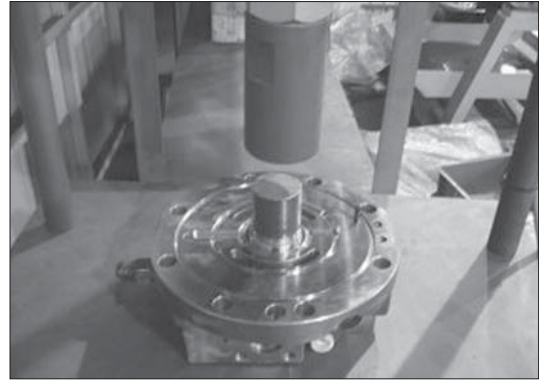

25098TM085

- (6) Assemble the spring pin (32) and parallel pin (29) into rear cover (34) by using round bar or small hammer.

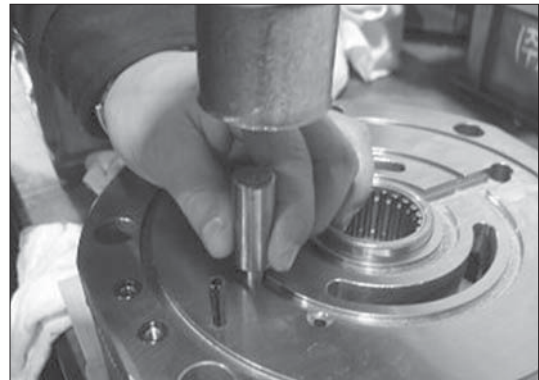

25098TM086

- (7) Assemble the valve plate (28) into rear cover (34).
Before assembling, apply some grease on contact surface of the valve plate.

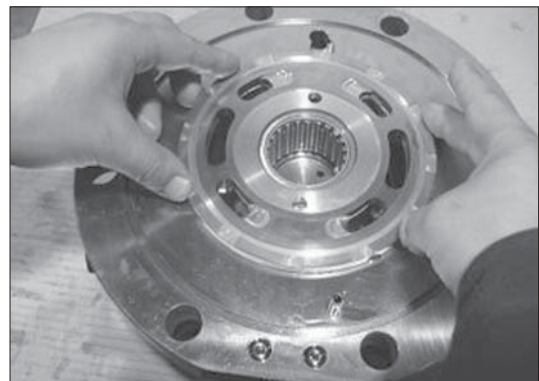

25098TM087

- (8) Apply some grease on the O-ring and fit it into groove.

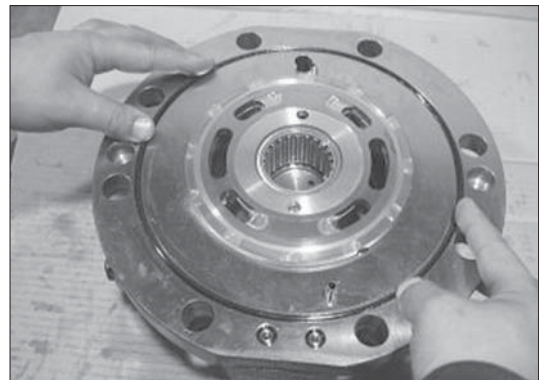

25098TM088

(9) Assemble the casing (1) on the assembling truck.

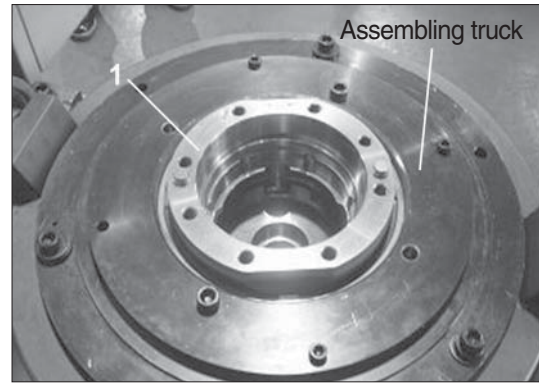

25098TM089

(10) Tight fit the oil seal (3) into the casing (1) by using jig.

※ Be careful direction of the oil seal.



25098TM090



25098TM091

(11) Assemble the thrust plate (4) into the casing (1).

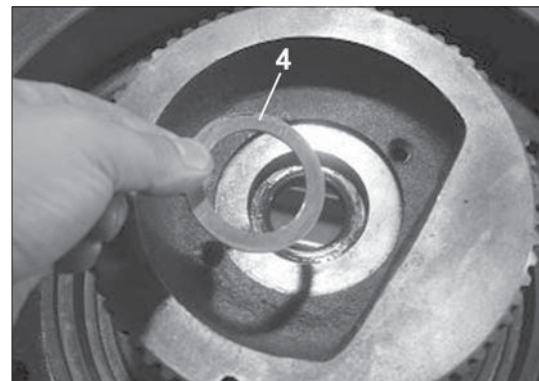

25098TM092

(12) Assemble the snap ring (5) into the casing (1) with the plier for retaining ring.

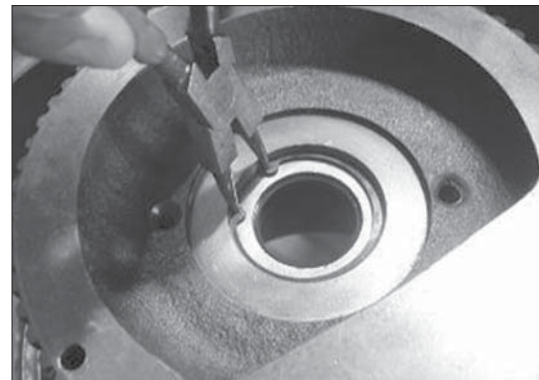

25098TM093

(13) Heat the roller bearing (9) and fit it into the shaft with shrink fitting.

- a. Shrink fitting can be used induction heating system and set the temperature at 100°C.
- b. Be careful not to damage the sliding surface of the oil seal of the shaft.



25098TM094



25098TM095

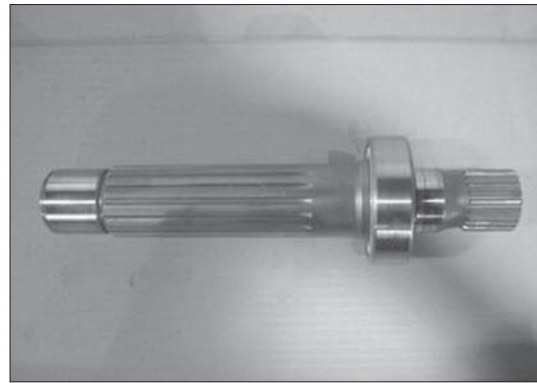

25098TM096

(14) Assemble the heat-fitted shaft (8) into casing (1).



25098TM097

(15) Assemble the snap ring (11) into the casing (1) with the plier for retaining ring.

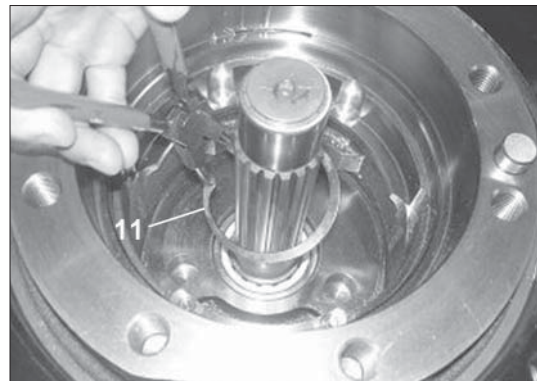

25098TM098

(16) Apply a little grease on the pivot (16, 2EA) and assemble it into the casing (1).

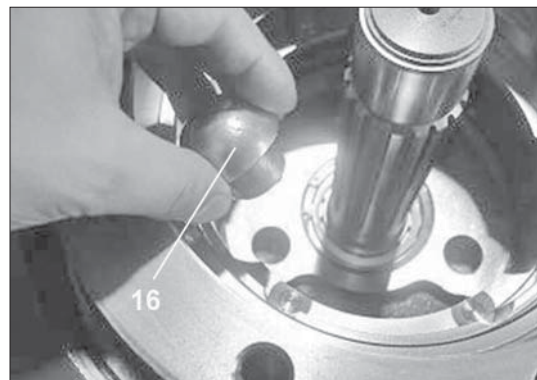

25098TM099

(17) Heat the piston seal (7) and fit it into the swash piston (6) and then tighten it a few minutes by band or tie. Loosen the band or tie and assemble it to the casing (1).



25098TM100

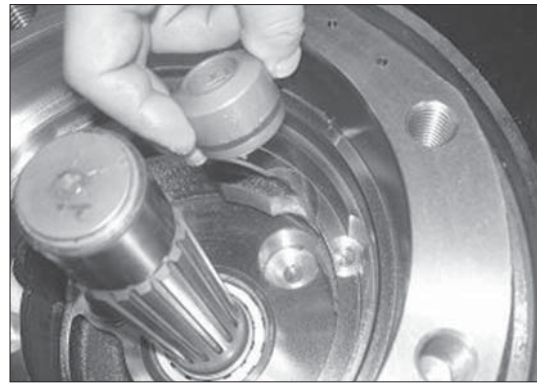

25098TM101

(18) Apply a little grease on the steel ball (15) and assemble it into the swash plate (17).

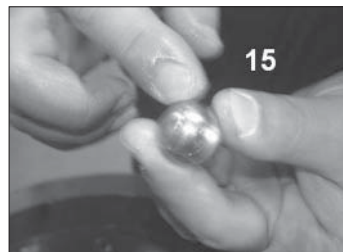

25098TM102



25098TM103

(19) Apply some grease on the steel ball hole of the swash plate (17) and assemble it casing (1).



25098TM104



25098TM105

(20) Assemble the spring (19), ball guide (20), retainer plate (21) and piston assy (22) into cylinder block (18) in order.

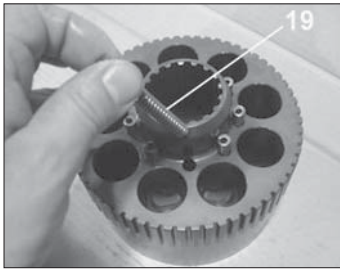

25098TM106

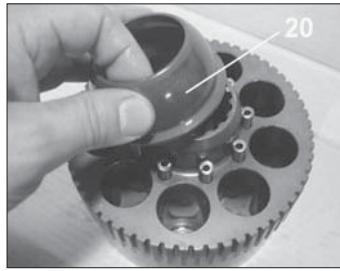

25098TM107

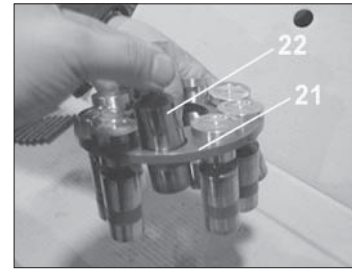

25098TM108

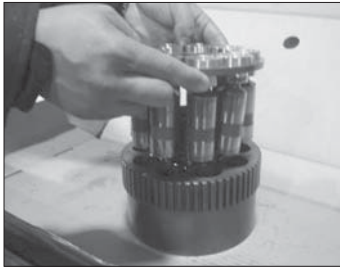

25098TM109



25098TM110

(21) Tilt the casing (1) sideways and assemble the cylinder block kit into the casing (1).

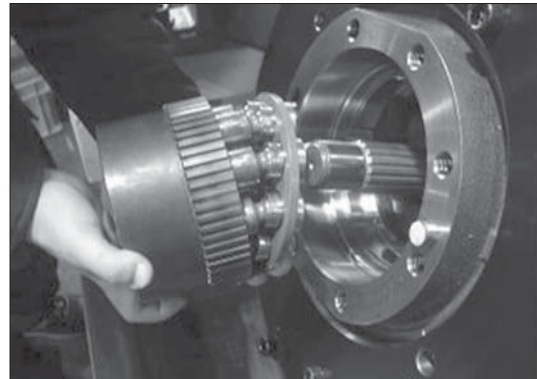

25098TM111

(22) Assemble the separated plate (24) and friction plate (23) into the cylinder block alternately.

Friction plate :

4EA

Separated plate :

5EA

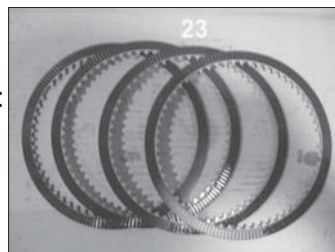

25098TM112

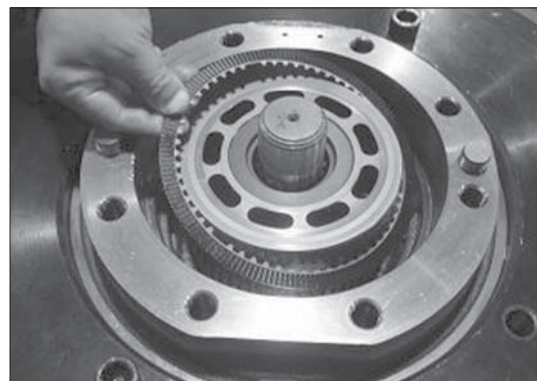

25098TM113

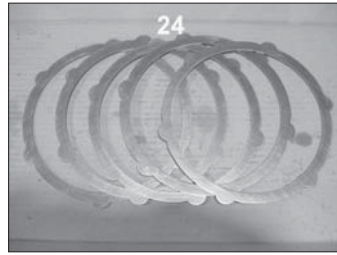

25098TM114

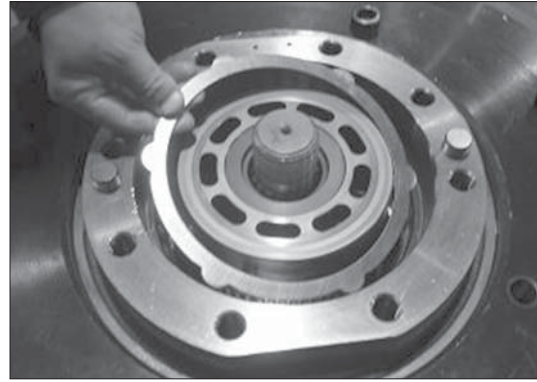

25098TM115

(23) Apply some grease on the D-ring and assemble it parking piston.

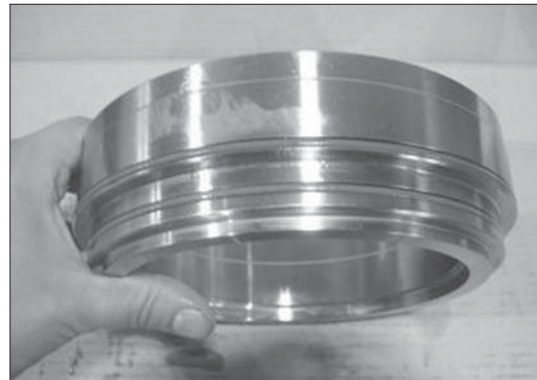

25098TM116

(24) Insert the parking piston into the casing and assemble it by using jig.

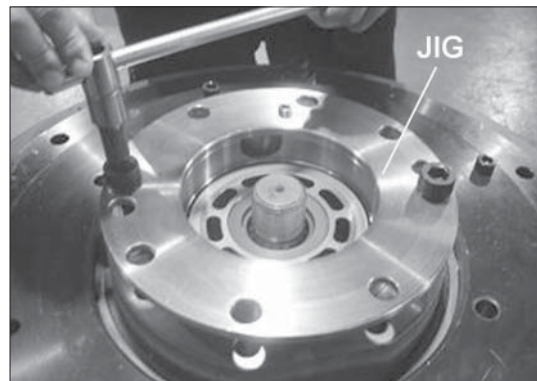

25098TM117

(25) Assemble the brake spring (30, 18EA) into the piston.

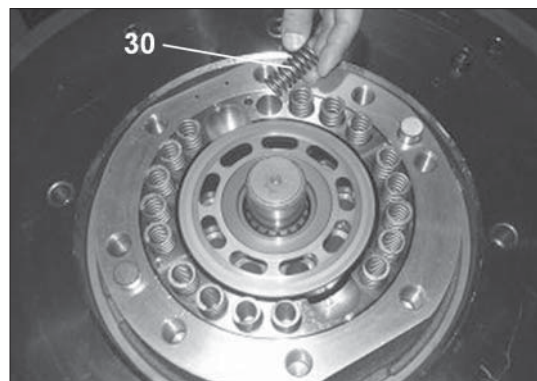

25098TM118

(26) Place the rear cover (34) on the casing (1).

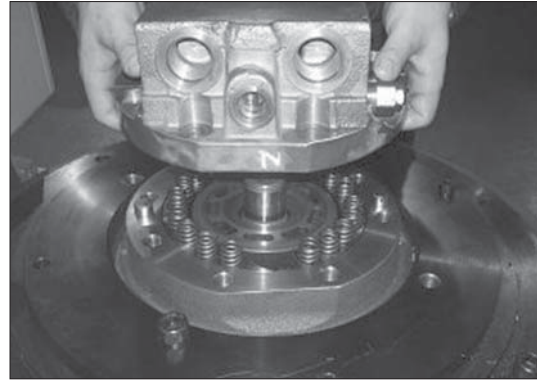

25098TM119

(27) Tighten the casing (1) and rear cover (34) specified torque with wrench bolt (54, 55) by using the impact wrench and torque wrench.

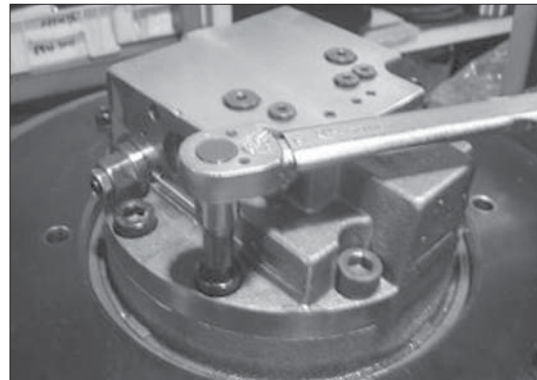

25098TM120

(28) Confirm the insert direction of the main spool assy (35) exactly and assemble it into the rear cover (34).

※ **Assure that four balance hole is directed VA port.**

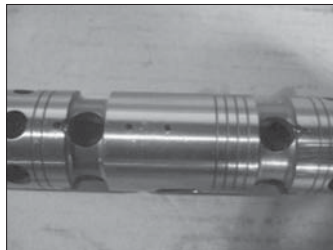

25098TM121

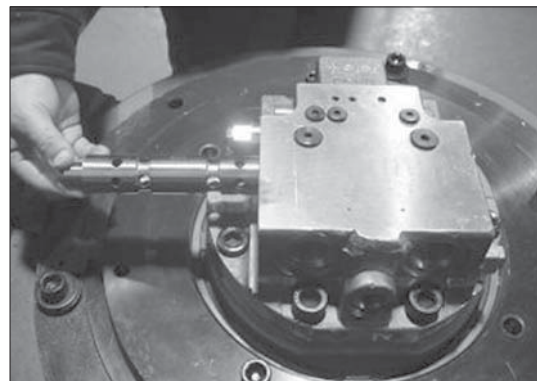

25098TM122

(29) Assemble the spring seat (41), spring (37) and main spool cover (36) into valve plate and tighten the wrench bolt (39, M12x35) by using L-wrench or impact wrench.

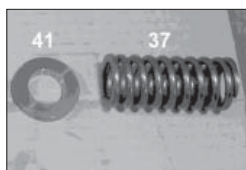

25098TM123

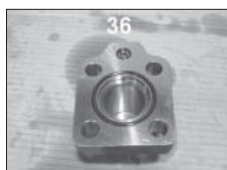

25098TM124

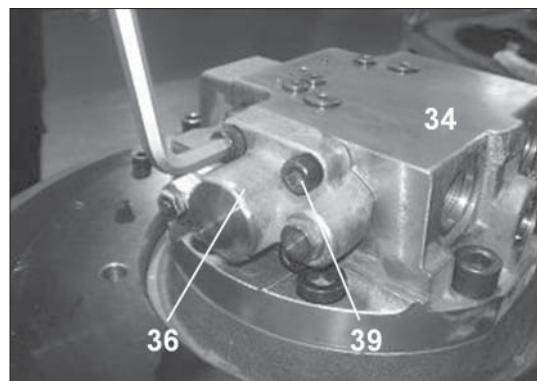

25098TM125

2) TRAVEL REDUCTION GEAR

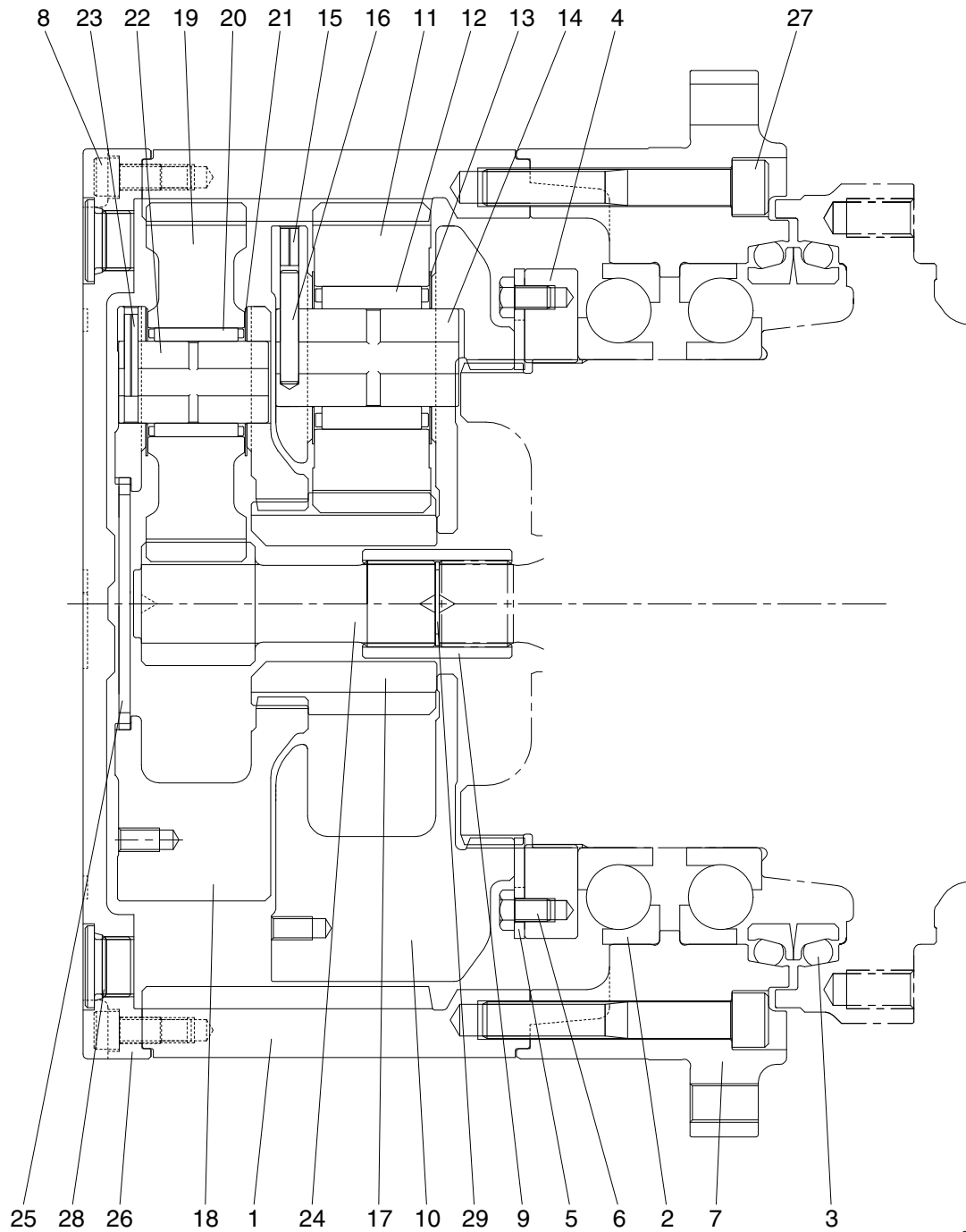

25092TM22

- | | | | | | |
|----|--------------------------|----|------------------|----|--------------------------|
| 1 | Gear ring | 12 | Needle bearing 2 | 22 | Carrier pin 1 |
| 2 | Ball bearing | 13 | Thrust washer 2 | 23 | Spring pin 1 |
| 3 | Floating seal assy | 14 | Carrier pin 2 | 24 | Sun gear 1 |
| 4 | Nut ring | 15 | Spring pin 2 | 25 | Thrust plate |
| 5 | Lock plate | 16 | Solid pin 2 | 26 | Cover |
| 6 | Hexagon socket head bolt | 17 | Sun gear 2 | 27 | Hexagon socket head bolt |
| 7 | Housing | 18 | Carrier 1 | 28 | Plug |
| 8 | Hexagon socket head bolt | 19 | Planetary gear 1 | 29 | Snap ring |
| 9 | Coupling | 20 | Needle bearing 1 | 30 | Name plate |
| 10 | Carrier 2 | 21 | Thrust washer 1 | 31 | Rivet |
| 11 | Planetary gear 2 | | | | |

6. DISASSEMBLING

1) GENERAL INSTRUCTIONS

- ▲ Combustibles such as white kerosene are used for washing parts.**
These combustibles are easily ignited, and could result in fire or injury.
Be very careful when using.
 - ▲ Internal parts are coated with gear oil during disassembling and are slippery.**
If a part slips off from your hand and falls, it could result in bodily injury or could damage the park.
Be very careful when handling.
- (1) Therefore, disassembling and assembling works should be performed on the clean place where dusts hardly gather.
Tools and kerosene to wash parts should also be clean and handled with great care.
- (2) Before disassembling, review the sectional drawing and prepare the required parts, depending on the purpose and the range of disassembling.
Seals, O-rings, etc., if once disassembled, are not reusable.
There are some parts that should be replaced as a subassembly.
Consult with the parts manual in advance.
- ▲ Take great care not to pinch your hand between parts while disassembling nor let fall parts on your foot while lifting them.**

2) DISASSEMBLING TRAVEL REDUCTION GEAR

(1) Preparation for disassembling

- ① The reduction units removed from excavator are usually covered with mud. Wash outside of propelling unit and dry it.
- ② Locate reducer in order for drain port to be at the lowest level loosen taper screw plug of drain port, and drain oil from reduction gear.

※ While oil is still hot, inside of the unit may be pressurized.

▲ Take care of the hot oil gushing out of the unit when loosening the plug.

③ Mark for mating

Put marks on each mating parts when disassembling so as to reassemble correctly as before.

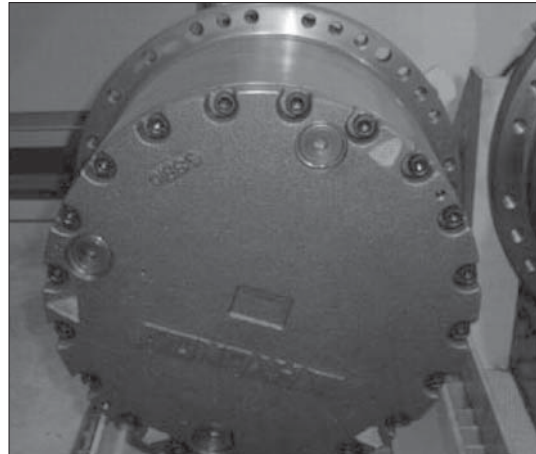

25098TM126

(2) Setting reduction unit (or whole propelling unit) on work stand for disassembling

- ① Remove 7/16-14UNC hexagon socket head bolts at 3 places from cover almost equally apart each other, and then install 7/16-14UNC eye bolts.

▲ Take great care not to pinch your hand between parts while disassembling nor let fall parts on your foot while lifting them.

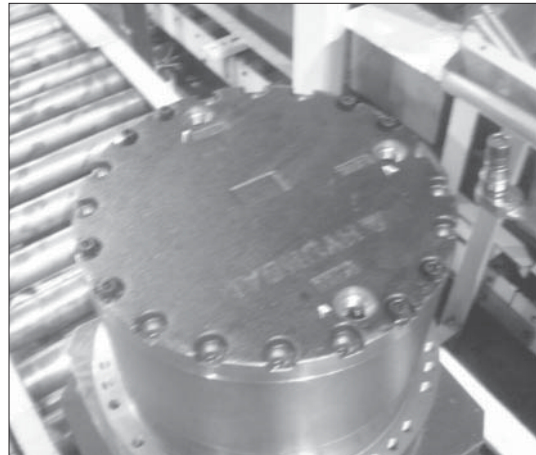

25098TM127

(3) Removing cover

- ① Remove the rest of 7/16-14UNC hexagon socket head bolts that secure cover and ring gear. Loosen all the socket bolts and then, disassemble cover.
- ② As the cover is adhered to ring gear, disassemble ring gear and cover by lightly hammering slantwise upward using sharpen punch inserted between the cover and ring gear.

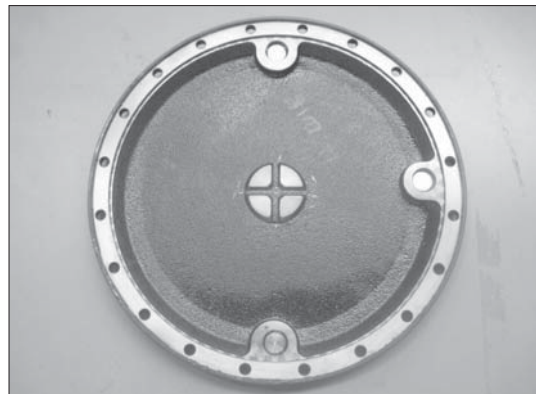

25098TM128

(4) Removing No.1 carrier sub assembly

- ① Screw three M10 eye-bolt in No.1 carrier and lift up and remove No.1 carrier assy.

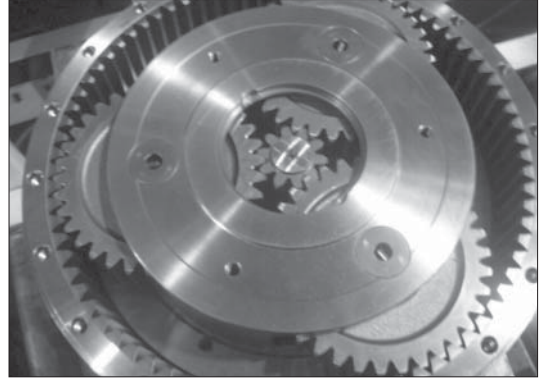

25098TM129

- ② Remove No.1 sun gear.

※ Be sure to maintain it vertical with the ground when disassembling No.1 sun gear.



25098TM130

(5) Removing No.2 carrier sub assembly

- ① Screw three M10 eye-bolt in No.2 carrier and lift up and remove No.2 carrier assy.

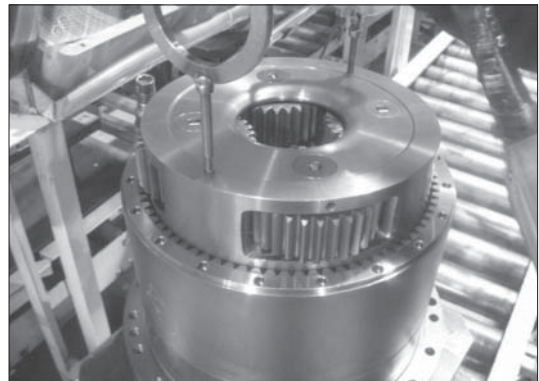

25098TM131

- ② Remove No.2 sun gear.

※ Be sure to maintain it vertical with the ground when disassembling No.1 sun gear.

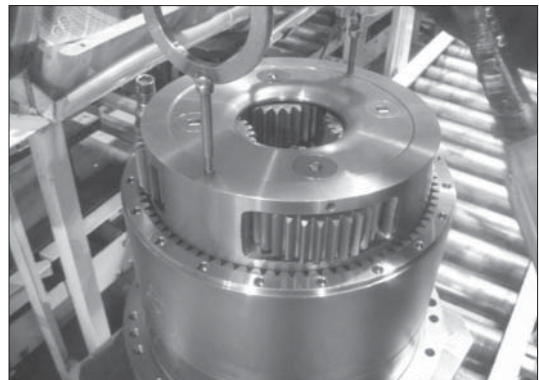

25098TM132

(6) Removing coupling

- ① Remove coupling.

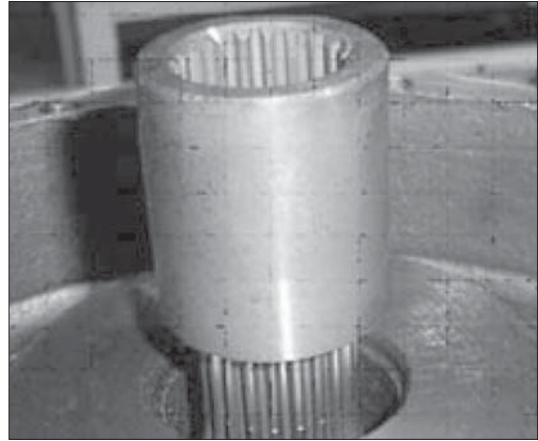

25098TM133

(7) Removing nut ring & lock plate

- ① Remove M12 hexagon head bolts that secure nut ring and lock plate.
 - ② Remove lock plate.
 - ③ Remove nut ring from motor casing.
- ※ Remove the nut ring by using the special tool for removing the nut ring.

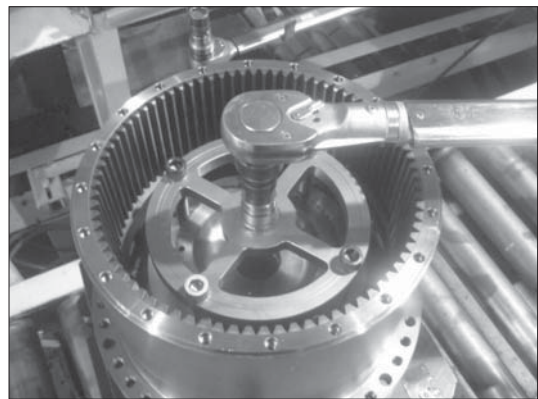

25098TM134

(8) Removing housing sub assembly & ring gear

- ① Screw 7/16-14UNC eye bolt in housing and lift up ring gear and housing assembly including angular bearing and floating seal.

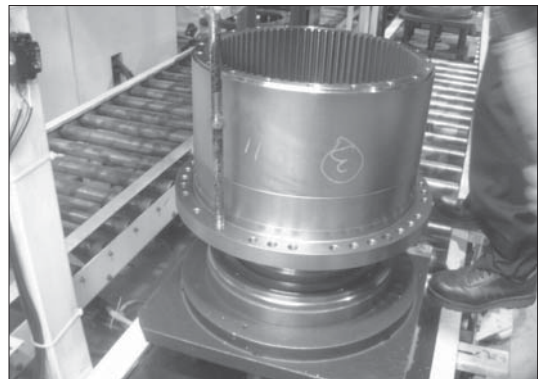

25098TM135

- ② Setting reduction unit on work stand for disassembling. Remove M16 hexagon socket head bolts that secure ring gear and housing assembly.

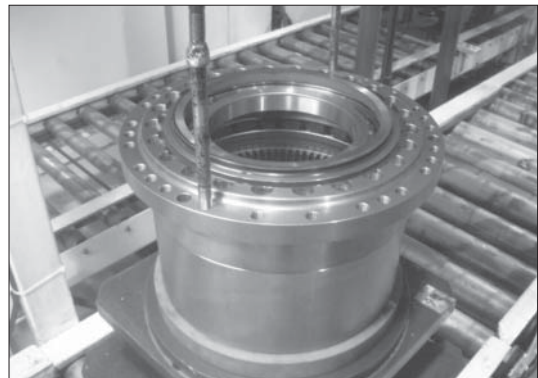

25098TM136

- ③ As the ring gear is adhered to housing assy, disassemble housing assy and ring gear by lightly hammering slantwise upward using sharpen punch inserted between the housing assy and ring gear.

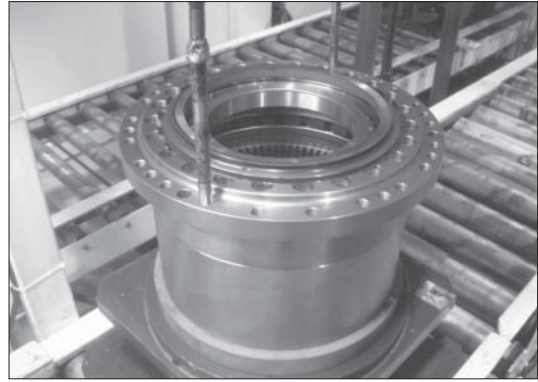

25098TM137

(9) Removing floating seal

- ① Lift up a piece of floating seal of motor side.

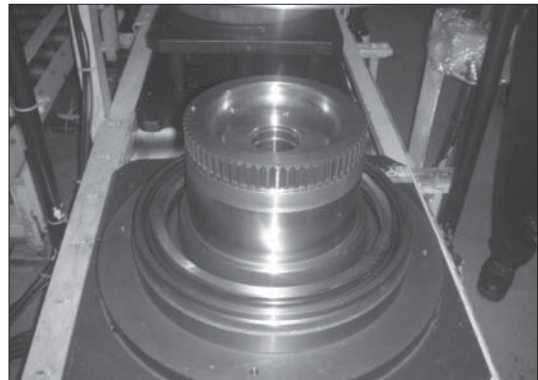

25098TM138

(10) Removing housing sub assembly

- ① Setting housing assembly on work stand for disassembling.
② After setting housing, lift up a piece of floating seal from housing and then remove it.

※ Don't disassemble angular bearing.

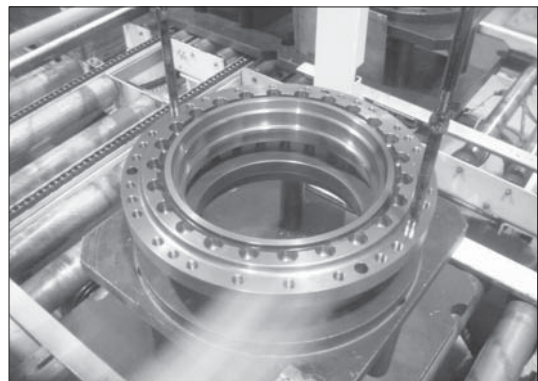

25098TM139

(11) Disassembling No.1 carrier

- ① Remove thrust plate.

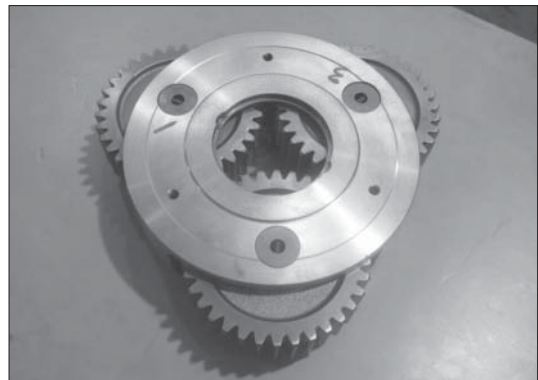

25098TM140

- ② Knock spring pin fully into No.1 pin.



25098TM141

- ③ Remove planetary, thrust washer, No.1 pin, bearing from carrier.

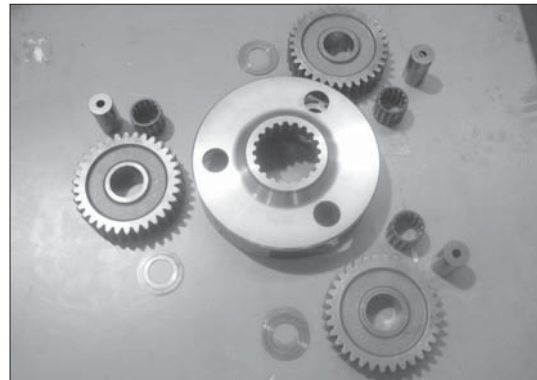

25098TM142

(12) Disassembling No.2 carrier

- ① Knock spring pin fully into No.2 pin.
- ② Remove No.2 solid pin.
- ③ Remove planetary, thrust washer, No.2 pin, bearing from carrier.

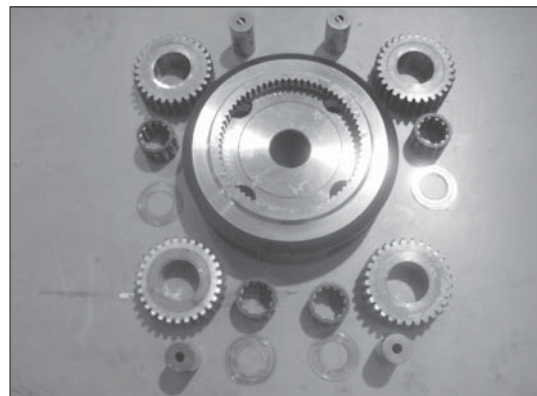

25098TM143

7. ASSEMBLY REDUTION UNIT

1) GENERAL NOTES

- (1) Clean every part by kerosene and dry them by air blow.
- (2) Surfaces to be applied by loctite must be decreased by solvent.
- (3) Check every part for any abnormal.
- (4) Each hexagon socket head bolt should be used with loctite No.242 applied on its threads.
- (5) Apply gear oil slightly on each part before assembling.

▲ Take great care not to pinch your hand between parts or tools while assembling nor let fall parts on your foot while lifting them.

Inspection before reassembling.

Thrust washer

- Check if there are seizure, abnormal wear or uneven wear.
- Check if wear is over the allowable limit.

Gear

- Check if there are pitting or seizure on the tooth surface.
- Check if there are cracks on the root of tooth by die check.

Bearing

- Rotate by hand to see if there are something unusual such as noise or uneven rotation.

Floating seal

- Check flaw or score on sliding surfaces or O-ring.

2) ASSEMBLING CARRIER 1 ASSY

- (1) Put No.1 carrier on a flat place.
- (2) Install No.1 needle bearing into No.1 planetary gear, put 2EA of No.1 thrust washer on both sides of planetary gear, and then, install it into carrier.



25098TM144

- (3) Install No.1 pin into No.1 carrier where the holes for No.1 pin are to be in line with those of No.1 carrier, and then, install spring pins into the holes.



25098TM145

(4) Caulk carrier holes as shown on the picture.



25098TM146

3) ASSEMBLING CARRIER 2 ASSY

- (1) Put No.2 carrier on a flat place.
- (2) Install No.2 needle bearing into No.2 planetary gear, put 2EA of No.2 thrust washer on both sides of planetary gear, and then, install it into carrier.

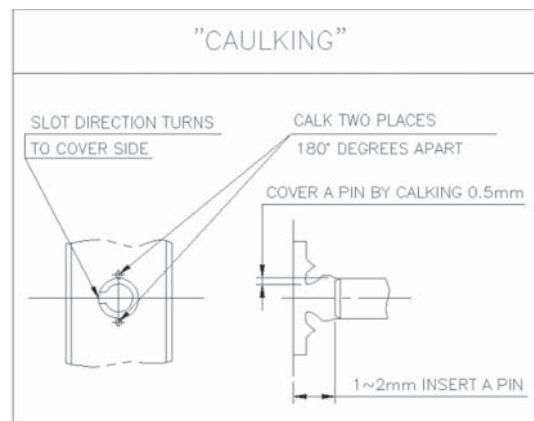

25098TM147

- (3) After install solid pin into the holes, install No.2 pin into No.1 carrier where the holes for No.1 pin are to be in line with those of No.1 carrier, and then, install spring pins into the holes.
- (4) Caulk carrier holes as shown on the picture.

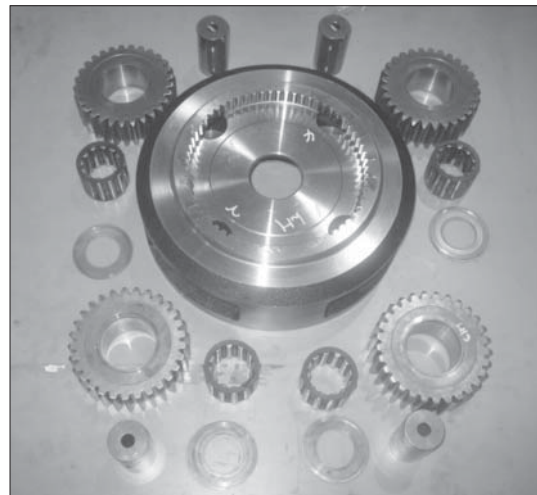

25098TM148

4) ASSEMBLING FLOATING SEAL

- (1) Assemble floating seal into motor by use of pressing jig.
Grease the contact parts for floating seal which is assembled into motor.
- ※ **Be sure to maintain it vertical with the ground when assembling bearing and floating seal.**

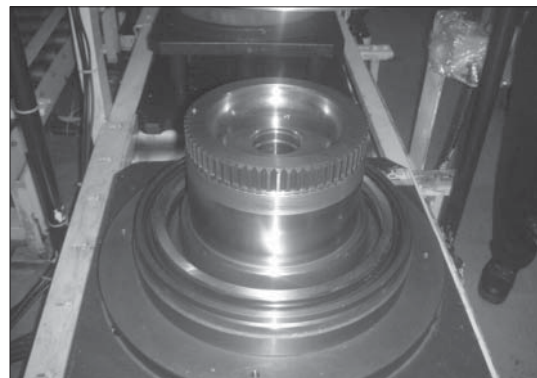

25098TM149

5) ASSEMBLING HOUSING

- (1) Heat housing at 60~70°C while clearing it out and then, assemble floating seal into housing by use of pressing jig.
- (2) Setting housing assembly on work stand for assembling.
Assemble angular bearing into housing by use of pressing jig.

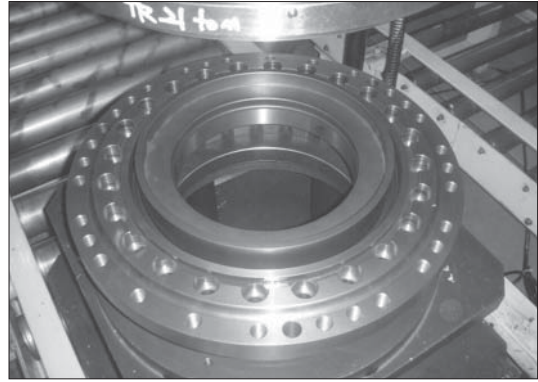

25098TM150

- (3) Assemble floating seal into housing by use of pressing jig.
Do not reuse the disassembling O-ring.
Grease the contact parts for floating seal which is assembled into housing.

※ **Be sure to maintain it vertical with the ground when assembling bearing and floating seal.**

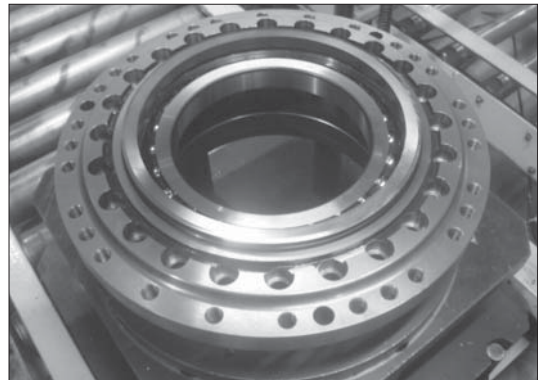

25098TM151

6) ASSEMBLING HOUSING ASSY AND RING GEAR

- (1) Setting ring gear on work stand for assembling.
Apply loctite #515 on ring gear for housing without gap.

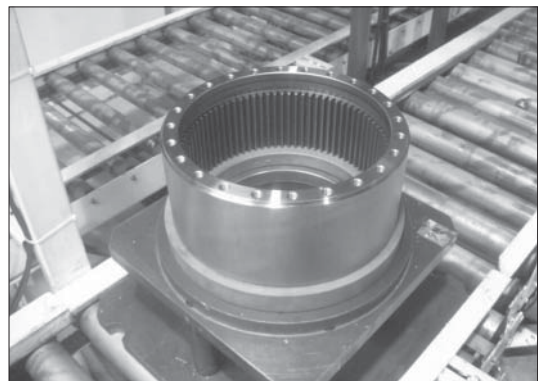

25098TM152



25098TM153

- (2) Install M16 eye-bolt on the tap of housing.
- (3) Lift housing and then, assemble into housing in order for bolt hole of ring gear and bolt hole of housing to be in line.
- (4) Apply loctite #242 on M16 hexagon socket head bolt, and then, bolt.

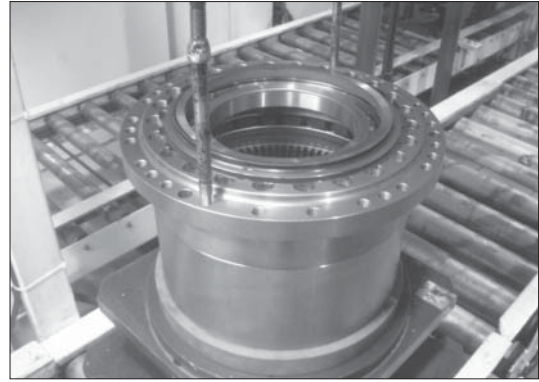

25098TM154

7) ASSEMBLING HOUSING ASSY AND MOTOR

- (1) Install 7/16-14UNC eye-bolt on the tap of ring gear.
 - (2) Assemble housing assembly into motor by use of hoist and eye-bolt.
- ※ **Be sure to tighten eye-bolt deep enough.**

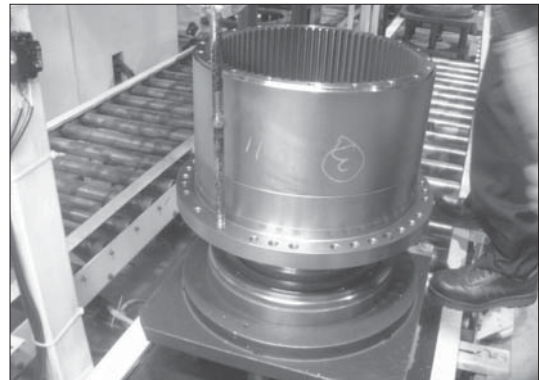

25098TM155

8) ASSEMBLING MAIN BEARING

- (1) Assemble angular bearing into housing by use of pressing jig.
- ※ **Be sure to maintain it vertical with the ground when assembling bearing.**



25098TM156

9) ASSEMBLING NUT RING AND LOCK PLATE

- (1) Tighten nut ring to specified torque, utilizing special tool.
- (2) After install lock plate, apply loctite #242 on M12 hexagon head bolt, and then, bolt. Tighten M12 hexagon head bolt to specified torque, with torque wrench.

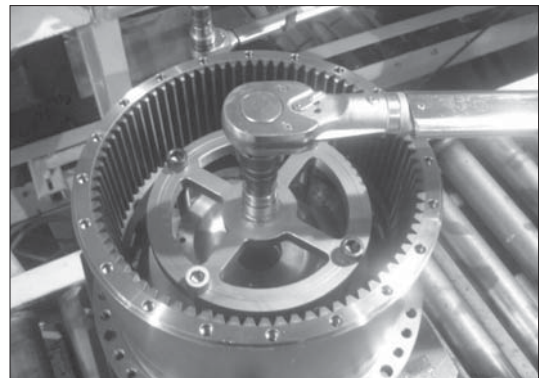

25098TM157

10) ASSEMBLING COUPLING

- (1) Install coupling on spline of the motor.

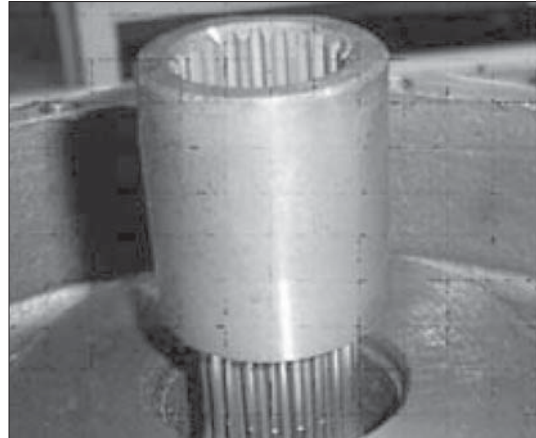

25098TM158

11) ASSEMBLING NO.2 CARRIER SUB ASSEMBLY

- (1) Install M10 eye-bolt on No.2 carrier assembly.
 - (2) Lift No.2 carrier assembly and then, slowly put it down on ring gear.
 - (3) Rotate planetary gear by hands and install on ring gear.
 - (4) Rotate No.2 carrier assembly by hands and install on motor.
- ※ **Match pin hole of No.2 Carrier with main(A,B) port of motor.**



25098TM159

12) ASSEMBLING NO.2 SUN GEAR

- (1) Install No.2 sun gear on the No.2 planetary gear, matching teeth of them.

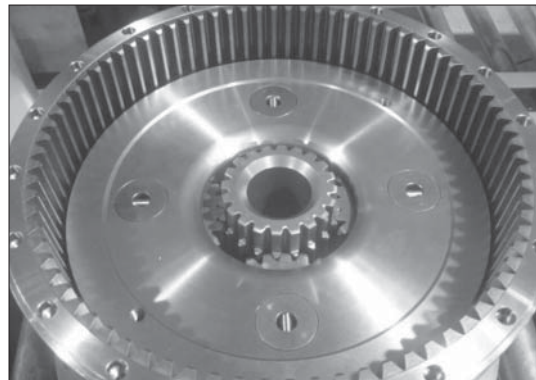

25098TM160

13) ASSEMBLING NO.1 CARRIER SUB ASSEMBLY

- (1) Install M10 eye-bolt on No.1 carrier assembly.
- (2) Lift No.1 carrier assembly and then, slowly put it down on ring gear.
- (3) Rotate planetary gear by hands and install on ring gear.
- (4) Rotate No.1 carrier assembly by hands and install on No.2 sun gear.

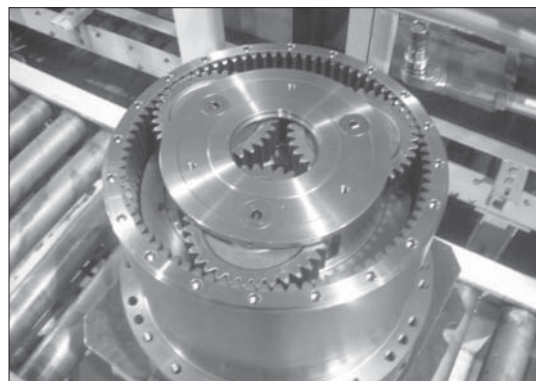

25098TM161

14) ASSEMBLING NO.1 SUN GEAR

- (1) Put down No.1 sun gear on No.1 carrier, maintaining it vertical with spline of coupling.
- (2) Install No.1 sun gear on No.1 planetary gear, matching their teeth.

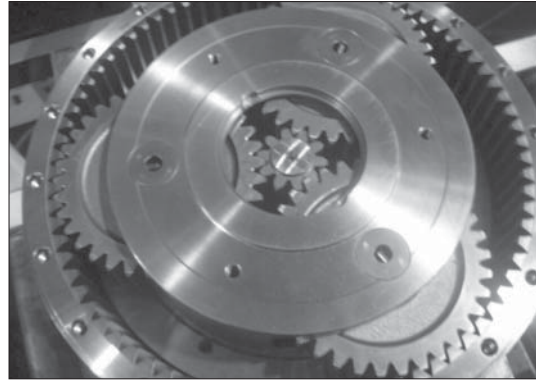

25098TM162

15) ASSEMBLING THRUST PLATE

- (1) Assembly thrust plate into No.1 carrier.
- ※ **Edge of thrust plate direction turns to cover side.**

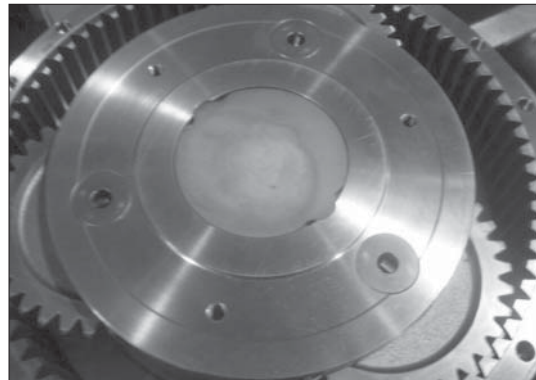

25098TM163

16) ASSEMBLING COVER

- (1) Apply loctite#515 on the ring gear for cover without gap.



25098TM164

- (2) Put cover on ring gear, apply loctite #242 on 7/16-14UNC hexagon socket head bolt, and then, bolt.
Tighten 7/16-14UNC hexagon socket head bolt to specified torque, with torque wrench.

- (3) Fill gear oil (6liter) into drain port.
- (4) Apply gear oil on PF3/4 hydraulic plug and then, bolt.

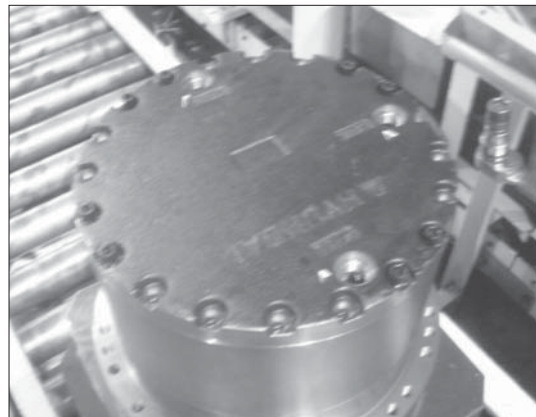

25098TM165

GROUP 6 TRAVEL DEVICE (TYPE 4)

1. REMOVAL AND INSTALL

1) REMOVAL

- (1) Swing the work equipment 90° and lower it completely to the ground.
- (2) Operate the control levers and pedals several times to release the remaining pressure in the hydraulic piping.
- (3) Loosen the breather slowly to release the pressure inside the hydraulic tank.

▲ Escaping fluid under pressure can penetrate the skin causing serious injury.

※ When pipes and hoses are disconnected, the oil inside the piping will flow out, so catch it in oil pan.

- (4) Remove the track shoe assembly.
For details, see **removal of track shoe assembly**.
- (5) Remove the cover.
- (6) Remove the hoses.
※ Fit blind plugs to the disconnected hoses.
- (7) Remove the bolts and the sprocket.
- (8) Sling travel device assembly (1).
- (9) Remove the mounting bolts (2), then remove the travel device assembly.
· Weight : 430 kg (950 lb)

2) INSTALL

- (1) Carry out installation in the reverse order to removal.
- (2) Bleed the air from the travel motor.
 - ① Remove the air vent plug.
 - ② Pour in hydraulic oil until it overflows from the port.
 - ③ Tighten plug lightly.
 - ④ Start the engine, run at low idling, and check oil come out from plug.
 - ⑤ Tighten plug fully.
- (3) Confirm the hydraulic oil level and check the hydraulic oil leak or not.

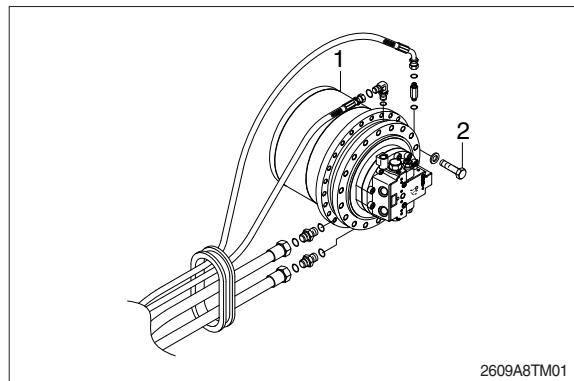

2. SPECIFICATION

1) TRAVEL MOTOR

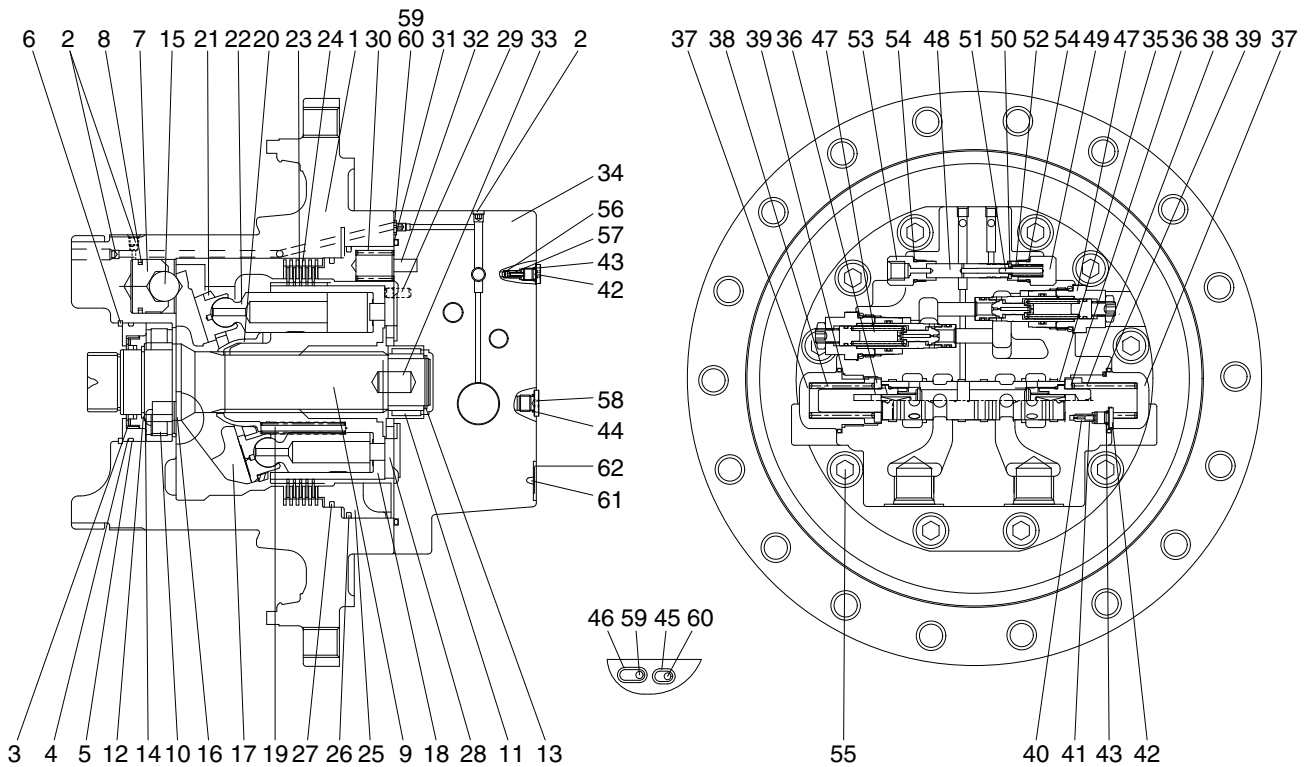

2609A2TM02

1	Casing	22	Piston assy	43	O-ring
2	Plug	23	Friction plate	44	O-ring
3	Oil seal	24	Separated plate	45	O-ring
4	Thrust block	25	Parking piston	46	O-ring
5	O-ring	26	D-ring	47	Relief valve
6	Snap ring	27	D-ring	48	Spool
7	Piston	28	Valve plate	49	Plug
8	Piston seal	29	Parallel pin	50	Spring seat
9	Shaft	30	Spring	51	Parallel pin
10	Cylinder roller bearing	31	O-ring	52	Spring
11	Needle bearing	32	Spring pin	53	Connector
12	Snap ring	33	Parallel pin	54	O-ring
13	Snap ring	34	Rear cover	55	Hexagon socket head bolt
14	Thrust plate	35	Main spool assy	56	Check valve
15	Steel ball	36	Spring seat	57	Spring
16	Pivot	37	Plug	58	Plug
17	Swash plate	38	Spring	59	Restrictor
18	Cylinder block	39	O-ring	60	Restrictor
19	Spring	40	Restrictor	61	Name plate
20	Ball guide	41	Spring	62	Rivet
21	Retainer plate	42	Plug		

2) TOOL AND TIGHTENING TORQUE

(1) Tools

Name of tools	B-size	Name of part applied
Hexagonal L-Wrench	4	Plug (2), Orifice screw (3, 4, 38)
	8	Hex socket bolt (50), Lock screw (62, 72), Plug (65)
	10	Hex socket bolt (49)
	46	Hex (57)
Socket wrench/ spanner	19	Hp plug (54)
	24	Hex nut (63)
	27	Hp plug (56)
Snap-ring plier (for holes, axis)		Ring stop (14), Ring lock (74)
Solder hammer		Needle bearing (34), Pin (5, 6, 36)
Torque wrench		Size : 500, 3000
Jig for assembling oil seal		Oil seal (73)
Induction heating apparatus for bearing		Roller bearing (13)

(2) Tightening torque

NO.	Part name	Standard	Size	Torque	
				kgf · m	lbf · ft
2	Plug	NPTF 1/16	4	0.9±0.2	6.51±1.45
3, 4, 38	Orifice screw	NPTF 1/16	4	0.7	5.06
49	Hex socket bolt	M12	10	10	72.33
50	Hex socket bolt	M10	8	6.7	48.46
54	Plug	PF 1/4	19	3.7	26.76
56	Plug	PF 1/2	27	11	79.56
57	Relief valve	HEX 27	27	34±3.4	246±24.6
63	Nut	M16	24	24	173.59
65	Plug	PF 3/8	8	7.5	54.25
70, 72	Hex socket bolt	M16	14	24	173.59
71	Hex socket bolt	M16	14	24	173.59

3. DISASSEMBLING

1) GENERAL INSTRUCTIONS

- ▲ Combustibles such as white kerosene are used for washing parts.**
These combustibles are easily ignited, and could result in fire or injury.
Be very careful when using.
 - ▲ Internal parts are coated with hydraulic fluid during disassembling and are slippery.**
If a part slips out of your hand and falls, it could result in bodily injury or could damage the park.
Be very careful when handling.
- (1) Generally, hydraulic equipment is precisely manufactured and clearances between each parts are very narrow. Therefore, disassembling and assembling works should be performed on the clean place where dusts hardly gather. Tools and kerosene to wash parts should also be clean and handled with great care.
 - (2) When motor is removed from the host machine, wash around the ports sufficiently and put the plugs so that no dust and/or water may invade. Take off these plugs just before the piping works when re-attach it to the host machine.
 - (3) Before disassembling, review the sectional drawing and prepare the required parts, depending on the purpose and the range of disassembling.
Seals, O-rings, etc., if once disassembled, are not reusable.
There are some parts that should be replaced as a subassembly.
Consult with the parts manual in advance.
 - (4) The piston can be inserted to whichever cylinder block for the initial assembling.
However, their combination should not be changed if they are once used. To reuse them, put the matching mark on both pistons and cylinder block before disassembling.
- ▲ Take great care not to pinch your hand between parts while disassembling nor let fall parts on your foot while lifting them.**

2) DISASSEMBLING TRAVEL MOTOR

- (1) Disassemble main spool cover (36) into rear cover (34) using spanner and torque wrench and then disassemble spring (37), main spool assy (35).

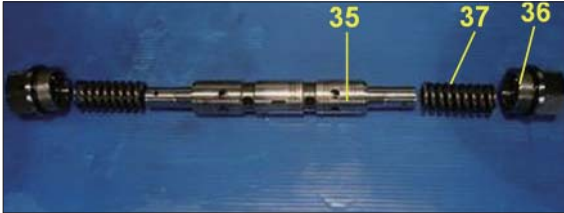

2609A8TM02

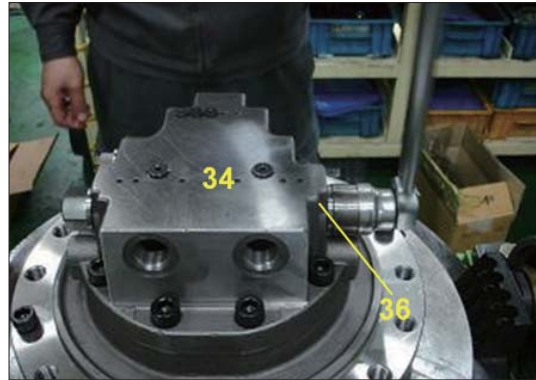

2609A8TM03

- (2) Disassemble wrench bolt (54) using torque wrench.



2609A8TM04

- (3) Take out rear cover (34) into casing (1).



2609A8TM05

- (4) Remove brake spring (30, 14EA)



2609A8TM06

(5) Disassemble parking piston (25) using jig.



2609A8TM07

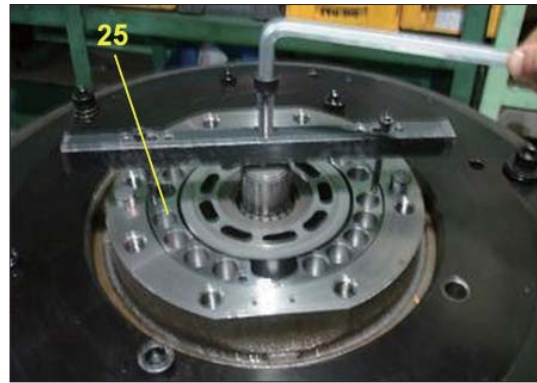

2609A8TM08

(6) Disassemble separate plate (24, 5EA) and friction plate (23, 4EA).

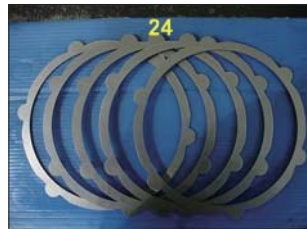

2609A8TM09



2609A8TM10



2609A8TM11



2609A8TM12

(7) Remove cylinder block kit.

It is easier to work by placing the casing (1) horizontal.



2609A8TM13

(8) Disassemble cylinder block (18), retainer plate (21), piston assy (22), ball guide (20) and spring (19) into cylinder block kit.



2609A8TM14



2609A8TM15

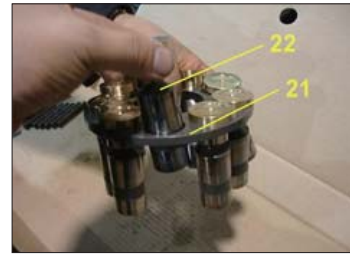

2609A8TM16



2609A8TM17

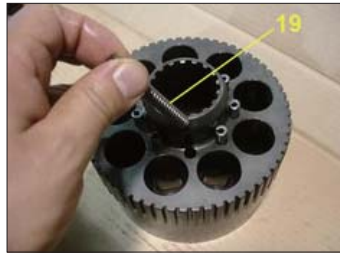

2609A8TM18

(9) Disassemble swash plate (17) into casing (1).



2609A8TM19



2609A8TM20

(10) Disassemble steel ball (15), swash piston (7) into casing (1).

※ Hole in the Casing(1) of two speed line is decomposed by injecting air.



2609A8TM21



2609A8TM22



2609A8TM23

(11) Disassemble pivot (16, 2EA) into casing (1).



2609A8TM24

(12) Disassemble snap ring (6) using pliers.



2609A8TM25

(13) Disassemble trust block (4) and oil-seal (3) into casing (1).

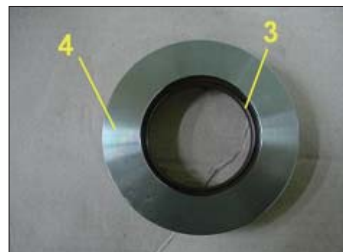

2609A8TM26



2609A8TM27

(14) In the casing (1), the arrow part of the shaft (8) using a rubber mallet taps and then disassemble the shaft (8) and bearing-roller (10) to the other side.



2609A8TM28

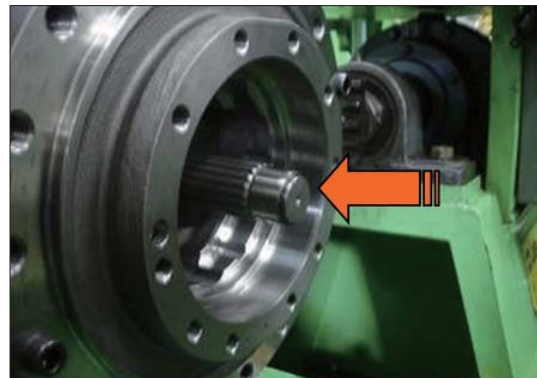

2609A8TM29

(15) Disassemble valve plate (28) into rear cover (34).

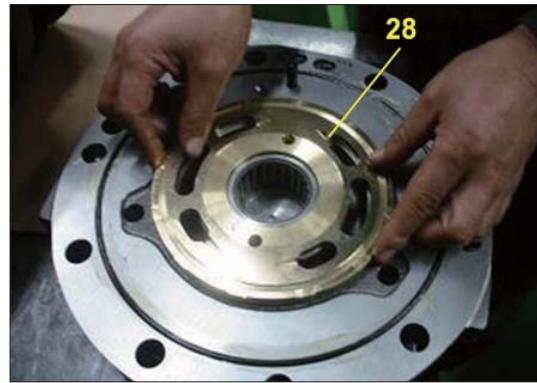

2609A8TM30

(16) Disassemble relief valve (46, 2EA) into rear cover (34) using the torque wrench.



2609A8TM31



2609A8TM32



2609A8TM33

(17) Disassemble plug (48), connector (52) into rear cover (34) using the torque wrench and then disassemble spring (51), spring seat (49), parallel pin (50) and spool (47) in regular sequence.



2609A8TM34



2609A8TM35



2609A8TM36

(18) Disassemble plug (57) into rear cover (34).

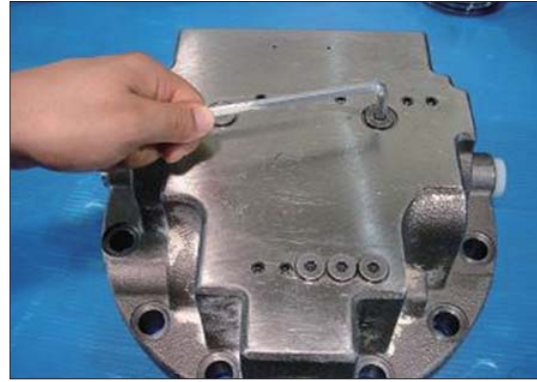

2609A8TM37

(19) Disassemble plug (57) into rear cover (34) and then disassemble spring (56), check valve (55) into rear cover (34) in regular sequence.

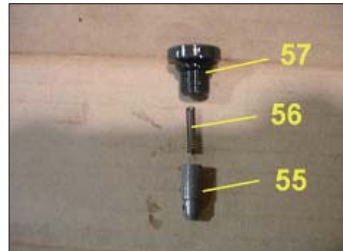

2609A8TM38

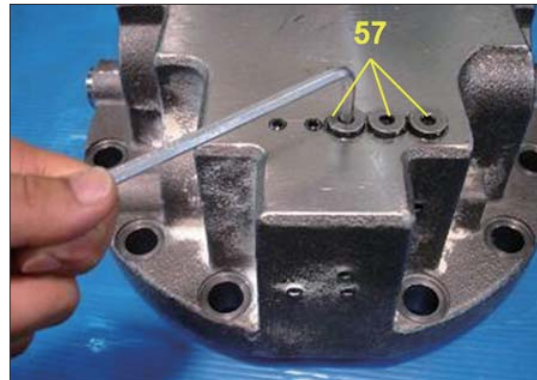

2609A8TM39

4. REASSEMBLING

1) ASSEMBLING MOTOR

- REAR COVER ASSY

- (1) Assemble check valve (55), spring (56) into rear cover (34) and then assemble plug (57) using L-wrench.

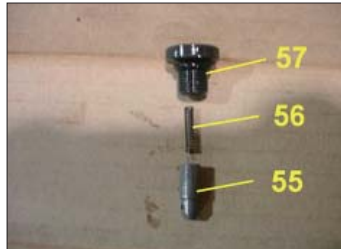

2609A8TM40

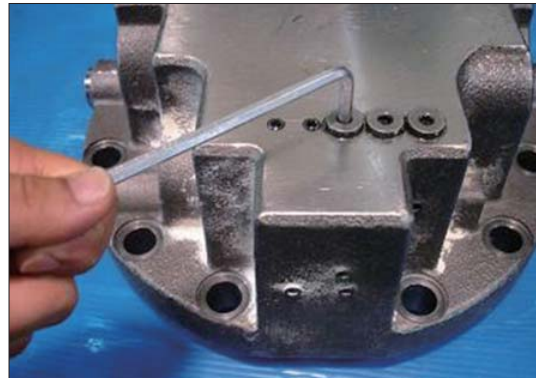

2609A8TM41

- (2) Apply loctite #242 on the NPTF 1/16 plug (2) and then assemble 12-NPTF 1/16 Plug (2) into rear cover(34).



2609A8TM42

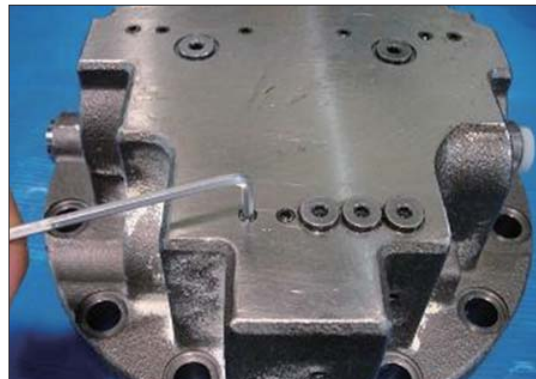

2609A8TM43

- (3) Assemble spool (47), parallel pin (50), spring seat (49) and spring (51) into rear cover (34) in regular sequence and then assemble plug (48) and connector (52).



2609A8TM44



2609A8TM45



2609A8TM46

- (4) Assemble relief valve (42, 2EA) into rear cover (34).



2609A8TM47



2609A8TM48



2609A8TM49

- (5) Press needle bearing (11) into rear cover (34) using jig.

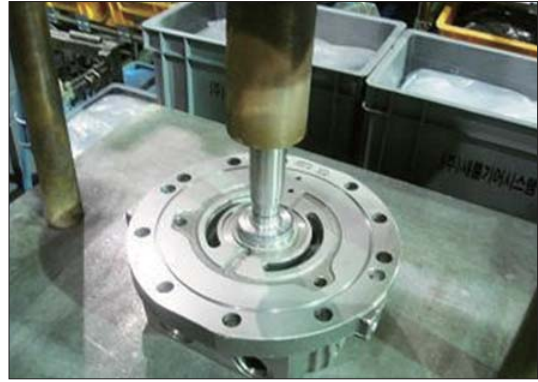

2609A8TM50

- (6) Assemble spring pin (32) and parallel pin (29) using small hammer.



2609A8TM51

- (7) Assemble valve plate (28) into rear cover (34).

- ※ **Apply grease to the valve plate contact and then assemble valve plate into rear cover (34).**



2609A8TM52

- (8) Apply grease to the O-ring and then assemble O-ring into rear cover (34).



2609A8TM53

(9) Install casing (1) into assembling jig.



2609A8TM54

(10) Assemble the heated Roller Bearing (10) onto the Shaft (8).

① The temperature of the Roller Bearing : 100°C.

Using tool : Heater.

※ **Be careful not to damage the sliding surface for the Oil seal on the shaft.**



2609A8TM55



2609A8TM56



2609A8TM57

(11) Assemble the heated needle bearing inner ring on the shaft (8).



2609A8TM58

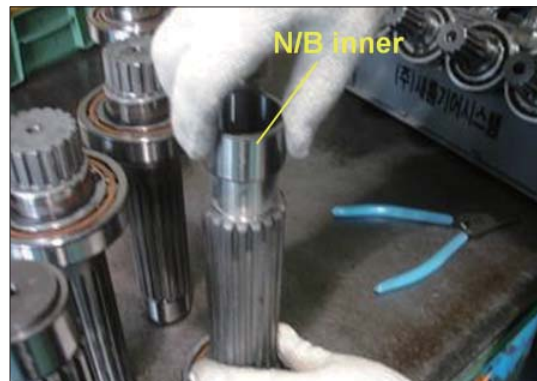

2609A8TM59

(12) Assemble snap ring (13) into Shaft (8) using pliers.



2609A8TM60

(13) Insert assembled shaft assy in the direction of the arrow into casing (1) using a rubber mallet.



2609A8TM61

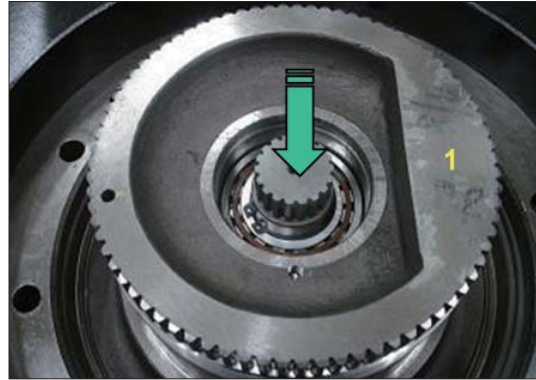

2609A8TM62

(14) Assemble oil seal(3) into trust block (4) with a assembling jig and press it into casing (1). Caution the direction of oil seal (3).

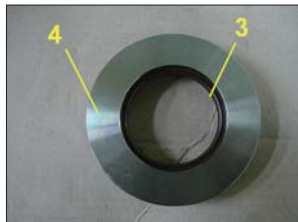

2609A8TM63

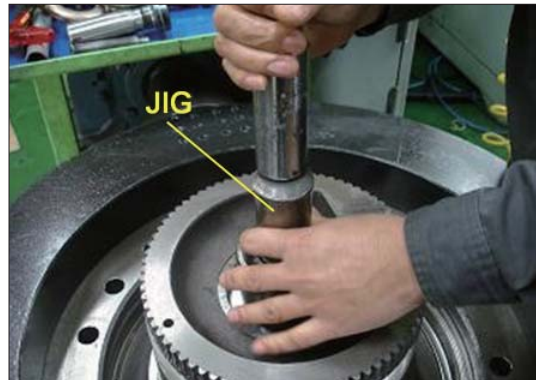

2609A8TM64

(15) Assemble snap ring(6) into casing(1) using pliers.



2609A8TM65

(16) Apply the grease to pivot (16, 2EA) and then assemble pivot (16) into casing(1).



2609A8TM66

(17) Warm piston seal (8) and assemble it on swash piston (7) and then bind the piston seal (8) with a bend for a minute. Remove the bend and assemble it into casing (1).

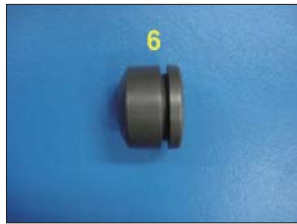

2609A8TM67



2609A8TM68

(18) Apply the grease to steel ball (15) and then assemble steel ball (15) into casing (1).



2609A8TM69



2609A8TM70

(19) Apply the grease to swash plate (17) and then assemble swash plate (17) into casing (1).



2609A8TM71



2609A8TM72

(20) Assemble spring (19), ball guide((20), retainer plate (21), piston assy (22) into cylinder block (18) in regular sequence.

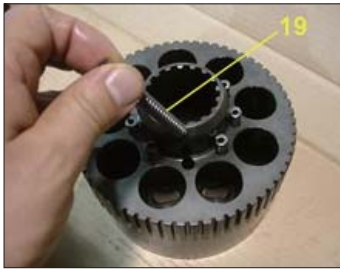

2609A8TM73



2609A8TM74

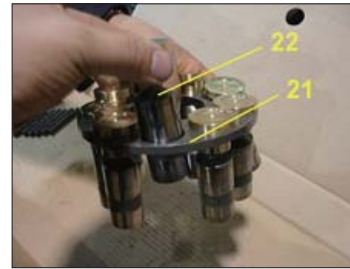

2609A8TM75



2609A8TM76



2609A8TM77

(21) Start the casing (1) and then assemble cylinder block kit into casing (1).



2609A8TM78

(22) Assemble separated plate (24), friction plate (23) into cylinder block in regular sequence.

Friction plate : 4EA

Separated plate : 5EA



2609A8TM79



2609A8TM80

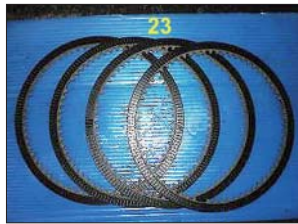

2609A8TM81



2609A8TM82

(23) Apply the grease to D-ring (26, 27) and then assemble D-ring (26, 27) into parking piston (25).

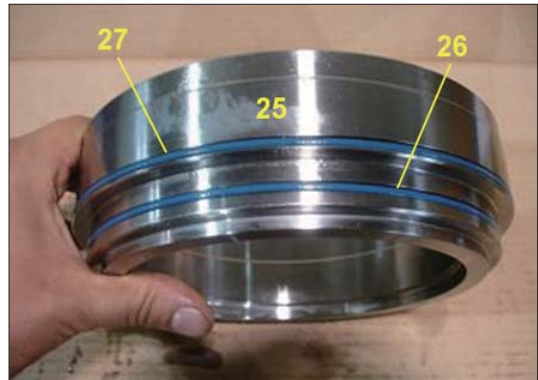

2609A8TM83

(24) Assemble parking piston into casing using jig.

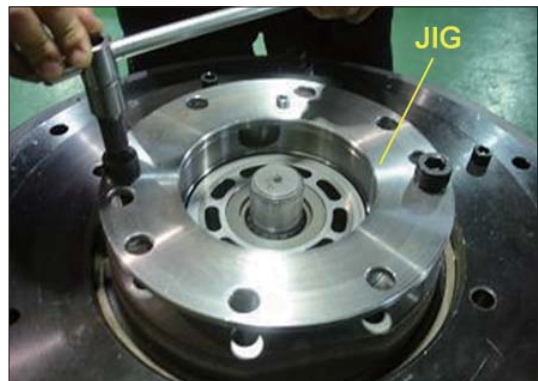

2609A8TM84

(25) Assemble brake spring (30, 18EA).



2609A8TM85

(26) Put on the rear cover (34) on the casing (1).



2609A8TM86

(27) Assemble rear cover (34) into casing (1) and then tighten the wrench bolt (54, 55) using torque wrench.



2609A8TM87

(28) Assemble main spool assy (35) into rear cover (34) after checking the direction to be correct.



2609A8TM88

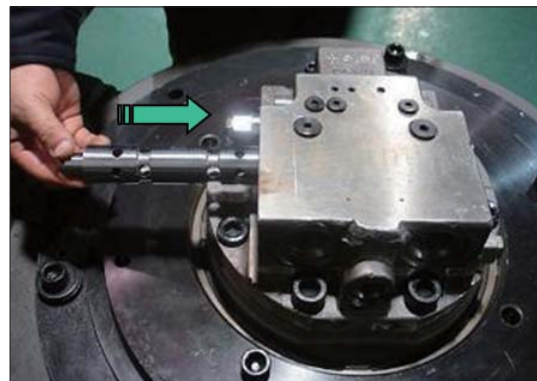

2609A8TM89

(29) Assemble spring (37), plug (36) into rear cover (34) in regular sequence and then plug (36) into rear cover (34) using torque wrench.



2609A8TM90



2609A8TM91

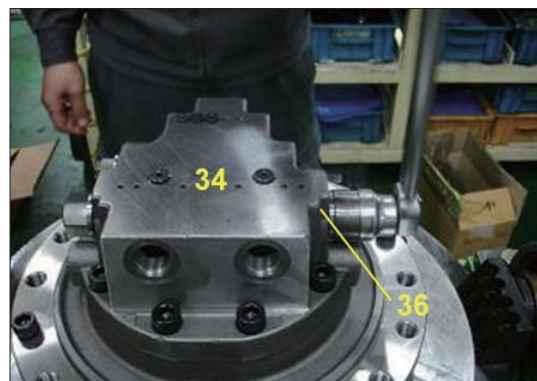

2609A8TM92

2) TRAVEL REDUCTION GEAR

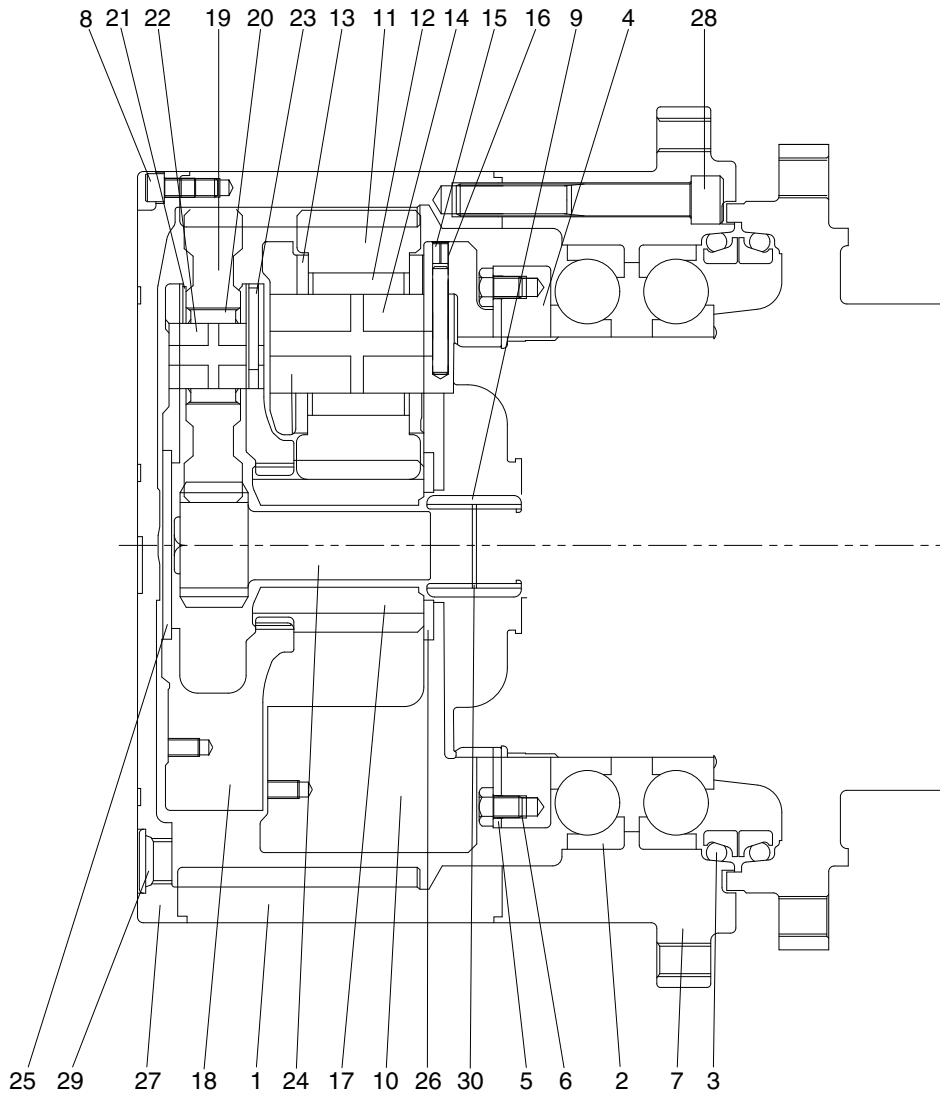

2609A2TM03

- | | | | | | |
|----|--------------------------|----|------------------|----|--------------------------|
| 1 | Gear ring | 11 | Planetary gear 2 | 21 | Thrust washer 1 |
| 2 | Ball bearing | 12 | Needle bearing 2 | 22 | Carrier pin 1 |
| 3 | Floating seal assy | 13 | Thrust washer 2 | 23 | Spring pin 1 |
| 4 | Nut ring | 14 | Carrier pin 2 | 24 | Sun gear 1 |
| 5 | Lock plate | 15 | Spring pin 2 | 25 | Thrust plate |
| 6 | Hexagon socket head bolt | 16 | Solid pin 2 | 26 | Thrust plate |
| 7 | Housing | 17 | Sun gear 2 | 27 | Cover |
| 8 | Hexagon socket head bolt | 18 | Carrier 1 | 28 | Hexagon socket head bolt |
| 9 | Coupling | 19 | Planetary gear 1 | 29 | Plug |
| 10 | Carrier 2 | 20 | Needle bearing 1 | 30 | Snap ring |

6. DISASSEMBLING

1) GENERAL INSTRUCTIONS

- ▲ Combustibles such as white kerosene are used for washing parts.**
These combustibles are easily ignited, and could result in fire or injury.
Be very careful when using.
 - ▲ Internal parts are coated with gear oil during disassembling and are slippery.**
If a part slips off from your hand and falls, it could result in bodily injury or could damage the park.
Be very careful when handling.
- (1) Therefore, disassembling and assembling works should be performed on the clean place where dusts hardly gather.
Tools and kerosene to wash parts should also be clean and handled with great care.
- (2) Before disassembling, review the sectional drawing and prepare the required parts, depending on the purpose and the range of disassembling.
Seals, O-rings, etc., if once disassembled, are not reusable.
There are some parts that should be replaced as a subassembly.
Consult with the parts manual in advance.
- ▲ Take great care not to pinch your hand between parts while disassembling nor let fall parts on your foot while lifting them.**

2) DISASSEMBLING TRAVEL REDUCTION GEAR

(1) Preparation for disassembling

- ① The reduction units removed from excavator are usually covered with mud. Wash outside of propelling unit and dry it.
- ② Locate reducer in order for drain port to be at the lowest level loosen taper screw plug of drain port, and drain oil from reduction gear.

※ While oil is still hot, inside of the unit may be pressurized.

▲ Take care of the hot oil gushing out of the unit when loosening the plug.

③ Mark for mating

Put marks on each mating parts when disassembling so as to reassemble correctly as before.

(2) Set the reduction unit on table

- ① Remove 7/16-14UNC hexagon socket head bolts at 3 places from cover almost equally apart each other, and then install 7/16-14UNC eye bolts.

▲ Take great care not to pinch your hand between parts while disassembling nor let fall parts on your foot while lifting them.

(3) Removing cover

- ① Remove 22 socket bolts (7/16-14UNC) those are attached to ring gear.
- ② Cover is stuck (27) to ring gear (1).
So use sharp chisel for removing cover (27) from ring gear (1).



2609A8TM02

(4) Removing sun gear No.1

Pull sun gear No.1 (24) vertically slow after removing thrust plate (25).



2609A8TM03

(5) Removing carrier No.1 sub assembly

Pull away carrier No.1 (18) with attached eye-bolt (M10) that is assembled to hole on carrier sub-assembly.



2609A8TM04

(6) Removing sun gear No.2

Pull away sun gear No.2 (17) for removing.



2609A8TM05

(7) Deassembleing carrier No.2 sub-assembly

Attach eye-bolt (M10) to the hole of carrier No.2 (10), and remove the carrier No.2 sub-assembly to lift up slowly.

※ **Keep horizontal to ground and make sure the eye-bolts to be safe operation.**



2609A8TM06

(8) Take away coupling

Take away the coupling (9) from casing (1).



2609A8TM07

(9) Lock plate

Release four hex head bolts (6, M12) and remove lock plate (5).



2609A8TM08

(10) Nut ring

Release nut ring with removing jig.



2609A8TM09

(11) Housing sub-assembly

Lift up housing part slowly with hoist after attaching eye-bolt (7/16-14UNC) on it. If you hit softly the center of motor with hammer and particular jig, you can remove the device easily.

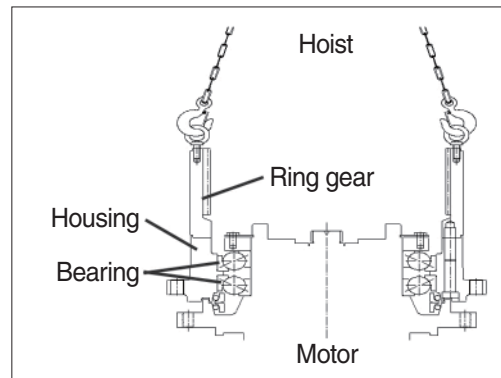

2609A8TM10

(12) Ring gear

- ① Reverse the housing sub-assembly part with machine, and remove floating seal (3) from the inside.



2609A8TM11

- ② Release 25 hex wrench bolts (28. M18) and remove ring gear (1) from housing (7).

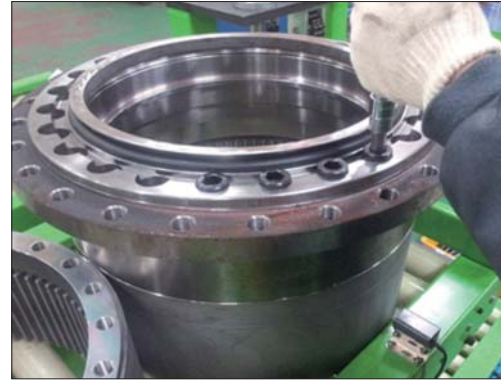

2609A8TM12

(13) Angular Bearing

Put the housing sub-assembly (7) like this figure. And hit each opposite side of bearing with driver and hammer.

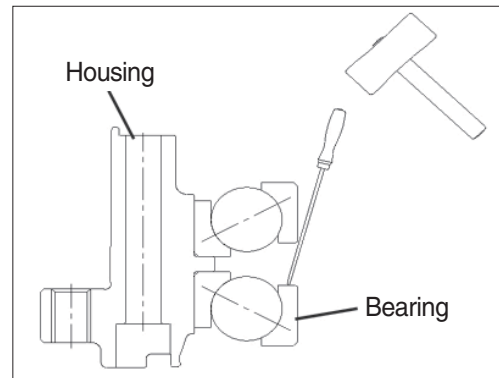

2609A8TM13

(14) Carrier No.1 sub-assembly

- ① Lay it on deassemblig jig. And remove pin No.1 (22) with press machine.



2609A8TM14

- ② Then remove planet gear No.1 (19) and thrust washer No.1 (21) from carrier No.1 (18).



2609A8TM15

(15) Carrier No.2 sub-assembly

Same as carrier No.1 (12) sub-assembly.



2609A8TM16

(16) Coupling

Remove snap ring (30) inside coupling (9) with nipper.



2609A8TM17

7. ASSEMBLY REDUTION UNIT

1) GENERAL NOTES

- (1) Clean every part by kerosene and dry them by air blow.
- (2) Surfaces to be applied by loctite must be decreased by solvent.
- (3) Check every part for any abnormal.
- (4) Each hexagon socket head bolt should be used with loctite No.242 applied on its threads.
- (5) Apply gear oil slightly on each part before assembling.

**▲ Take great care not to pinch your hand between parts or tools while assembling nor let fall parts on your foot while lifting them.
Inspection before reassembling.**

Thrust washer

- Check if there are seizure, abnormal wear or uneven wear.
- Check if wear is over the allowable limit.

Gear

- Check if there are pitting or seizure on the tooth surface.
- Check if there are cracks on the root of tooth by die check.

Bearing

- Rotate by hand to see if there are something unusual such as noise or uneven rotation.

Floating seal

- Check flaw or score on sliding surfaces or O-ring.

2) ASSEMBLING CARRIER 1 SUB-ASSY

- (1) Put carrier No.1 (18) on the flat table.
- (2) Insert needle bearing No.1 (20) in planet gear No.1 (20), and attach 2 thrust washers No.1 (21) on the both side of planet gear No.1. then assemble them in carrier No.1 (18).

※ **When assembling thrust washer, rounded edge-side should be facing casting side of carrier.**

- (3) Insert pin No.1 (22) into pinhole of carrier correctly.

※ **Insert careful the pin not to scratch thrust washer and needle bearing.**



2609A8TM18



2609A8TM19

(4) Press spring pin No.1 (23) with jig and strike round spring pinhole (2 symmetrical point) with tool.

※ **After striking, draw the line by marker pen.**

※ **Check swinging conditon of planet gears.**

(5) Press two more pins and spring pins on the same way.



2609A8TM20

3) ASSEMBLING CARRIER 2 SUB-ASSY

(1) Put thrust plate (26) inside of carrier No.2 (10).



2609A8TM21

(2) Insert needle bearing No.2 (12) in planet gear No.2 (11) and attach 2 thrust washers No.2 (13) on the both side of planet gear No.2. Then assemble them in carrier No.2 (10).

※ **When assembling thrust washer, rounded edge-side should be facing casting side of carrier.**

(3) Insert pin No.2 (14) into pinhole of carrier No.2 correctly.

※ **Insert careful pin No.2 not to scratch thrust washer and needle bearing.**



2609A8TM22

(4) Insert solid pin No.2 (16) with pressing jig and insert spring pin No.2 (15) in the same position. When insertion is done, strike inner circle of spring pin (2 symmetrical point) with tool.

※ **After striking, draw the line by marker pen.**

※ **Check the spining condition of planet gear.**

(5) Insert two more pins and spring pins on the same way.



2609A8TM23

4) ANGULAR BEARING

(1) Put the jig on housing (7) and insert angular bearing (2) into it with pressing machine, and turn down the upside of housing (7) by reversing machine.

※ Check the direction of bearing when inserting it.

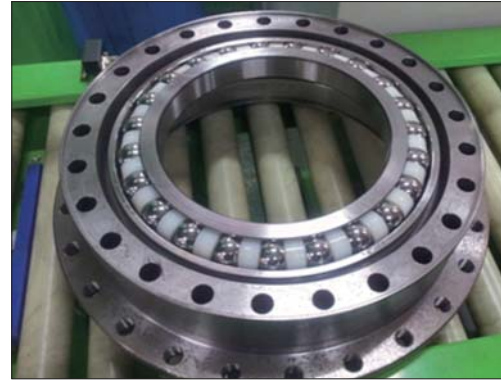

2609A8TM24

(2) Insert angular bearing (2) into reversed housing (7) on the same way.

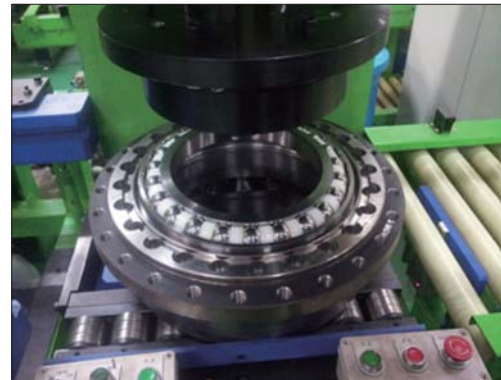

2609A8TM25

5) ASSEMBLING FLOATING SEAL

(1) Paint alchole on floating seal (3) and polish it.



2609A8TM26

(2) Put floating seal (3) on the right position of housing (3) and insert it by pressing jig. After complete, check the condition by lifting with hand softly.

※ Keep clean on surface of floating seal while assembling.



2609A8TM27

(3) Put the gauge for seal measurement on floating seal (3) and check the horizontal angle by gauge scale.

※ **Two gauge scales should be same.**
(pass inspection)



2609A8TM28

(4) Attach floating seal to motor that will be assembled with housing (on the same way to (1), (2))

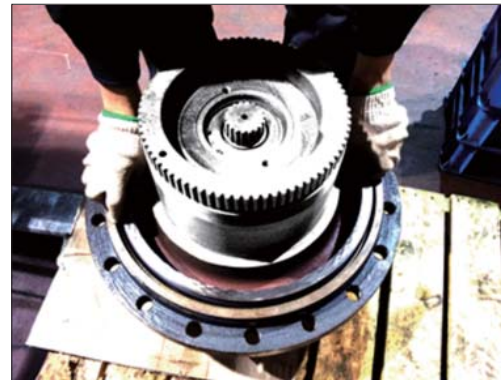

2609A8TM29

(5) Put the measuring jig on floating seal (3) and check the horizontal angle condition with both gauge scale.

※ **Two gauge scales should be same.**
(pass inspection)

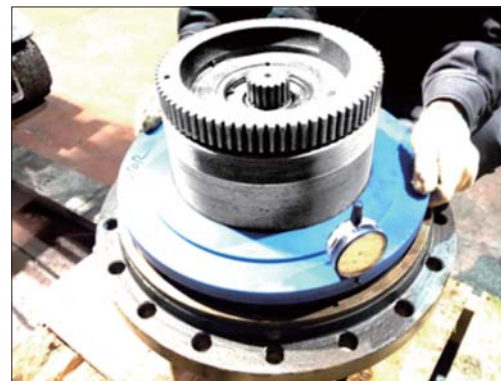

2609A8TM30

6) ASSEMBLING RING GEAR

(1) Put ring gear (1) on contact surface (should be upside) of housing (7).

(2) Paint loctite #515 on ring gear (1) and put on housing (7). Then assemble 25 hexwrench bolts (28, M18)

※ **Paint loctite #262 on hex-wrench bolts (28) before assembling.**

※ **Tightening torque : $38.5 \pm 3.8 \text{ kgf} \cdot \text{m}$**
($278.5 \pm 27.5 \text{ lbf} \cdot \text{ft}$)

※ **Bolts should be assembled with luster preventing oil.**

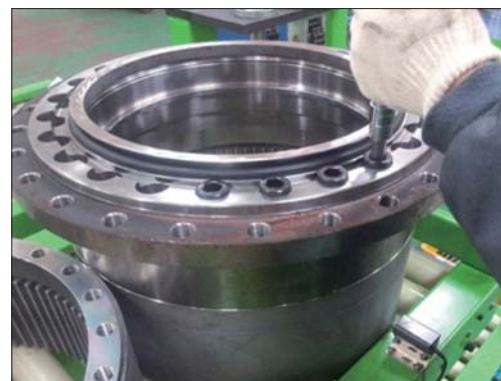

2609A8TM31

7) ASSEMBLING NUT RING

- (1) Put housing (7) sub-assembly upside down (ring gear side is up), and attach it to motor by lifting with hoist. (shaking it lightly)
 - (2) When housing (7) sub-assembly is set, put nut ring (4) on it, and assemble with jig.
- ※ **Tightening torque for assembling nut ring :**
 $66 \pm 6.0 \text{ kgf} \cdot \text{m}$ ($477.3 \pm 43.3 \text{ lbf} \cdot \text{ft}$)
 - ※ **Floating seal should not be damaged or separated while assembling.**



2609A8TM32

8) ASSEMBLING LOCK PLATE

- (1) Put lock plate (5) on nut ring (4) to fit to M12 bolt hole. Then assemble 4 hex-head bolts (6, M12)
- ※ **Paint loctite #262 on hex-head bolts.**
 - ※ **Tightening torque : $6.05 \pm 0.6 \text{ kgf} \cdot \text{m}$**
 $(43.8 \pm 4.3 \text{ lbf} \cdot \text{ft})$
 - ※ **Bolts should be assembled with luster preventing oil.**



2609A8TM33

9) ASSEMBLING COUPLING

- (1) Attach snap ring (3) into coupling (9) with nipper.



2609A8TM34

- (2) Put coupling (9) on motor shaft to fit.



2609A8TM35

10) ASSEMBLING NO.2 CARRIER SUB-ASSY

- (1) Lift carrier No.2 subassembly and put on ring gear (1), and fit it into internal side of ring gear (1). Then hit urethan hammer to fit.

※ Check turning and cocking condition before assembling.



2609A8TM36

11) ASSEMBLING NO.2 SUN GEAR

- (1) Insert sun gear No.2 (17) in the middle of carrier No.2 sub assembly and make it fit in carrier No.2.



2609A8TM37

12) ASSEMBLING NO.1 CARRIER SUB-ASSY

- (1) Lift carrier No.1 sub-assembly and put it into ring gear (1) and shake carrier No.1 to fit into ring gear.

※ Check turning and cocking condition before assembling.



2609A8TM38

13) SWINGING TORQUE INSPECTION

- (1) Attach inspection jig before assembling sun gear No.1 (24).



2609A8TM39

(2) Attach torque wrench to the jig, check the torque when it swings.

※ **Swinging torque : below 3.0 kgf · m (21.7 lbf · ft)**



2609A8TM40

14) ASSEMBLING NO.1 SUN GEAR

(1) Remove the jig and wrench after torque inspection complete. And assemble sun gear No.1 (24) with pushing round to fix to the center of carrier No.1



2609A8TM41

15) ASSEMBLING THRUST PLATE

(1) Put thrust plate (25) on carrier No.1 sub assembly. And paint loctite #515 on flat side of ring gear (1).

※ **When assembling thrust washer, rounded edge-side should be facing casting side of carrier.**



2609A8TM42

16) ASSEMBLING COVER

(1) Attach cover on ring gear (1) with assembling 22 hex-wrench bolts (8, 7/16-16UNC).

※ **Paint loctite #262 on screw of hex bolts.**

※ **Tightening torque : 8.1 ± 0.8 kgf · m
(58.6 ± 5.8 lbf · ft)**

※ **Bolts should be assembled with luster preventing oil.**



2609A8TM43

17) ASSEMBLING OIL INJECTION

- (1) Inject the oil (10 ℓ) through PF3/4 hole on cover (27).



2609A8TM44

18) ASSEMBLING PLUG

- (1) Assemble 3 plugs (29, PF3/4) after oil injection complete.

※ **Tightening torque** : $10 \pm 1.0 \text{ kgf} \cdot \text{m}$
($72.3 \pm 7.2 \text{ lbf} \cdot \text{ft}$)



2609A8TM45