

GROUP 4 MAIN CONTROL VALVE

1. REMOVAL AND INSTALL OF MOTOR

1) REMOVAL

- (1) Lower the work equipment to the ground and stop the engine.
- (2) Operate the control levers and pedals several times to release the remaining pressure in the hydraulic piping.
- (3) Loosen the breather slowly to release the pressure inside the hydraulic tank.
- ▲ **Escaping fluid under pressure can penetrate the skin causing serious injury.**
 - ※ When pipes and hoses are disconnected, the oil inside the piping will flow out, so catch it in oil pan.
- (4) Remove the wirings for the pressure sensors and so on.
- (5) Remove bolts and disconnect pipe.
- (6) Disconnect pilot line hoses.
- (7) Disconnect pilot piping.
- (8) Sling the control valve assembly and remove the control valve mounting bolt and bracket.
 - Weight : 220 kg (485 lb)
- (9) Remove the control valve assembly.
When removing the control valve assembly, check that all the piping have been disconnected.

2) INSTALL

- (1) Carry out installation in the reverse order to removal.
- (2) Bleed the air from below items.
 - ① Cylinder (boom, arm, bucket)
 - ② Swing motor
 - ③ Travel motor
 - ※ See each item removal and install.
- (3) Confirm the hydraulic oil level and recheck the hydraulic oil leak or not.

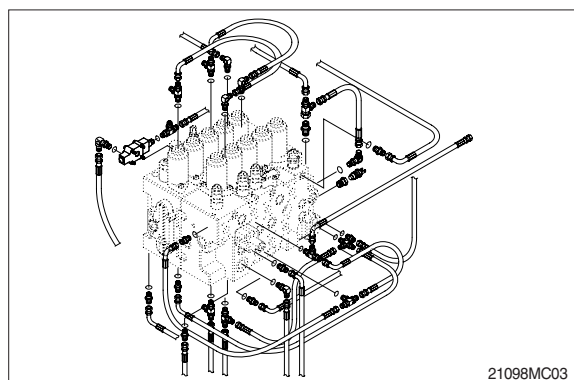
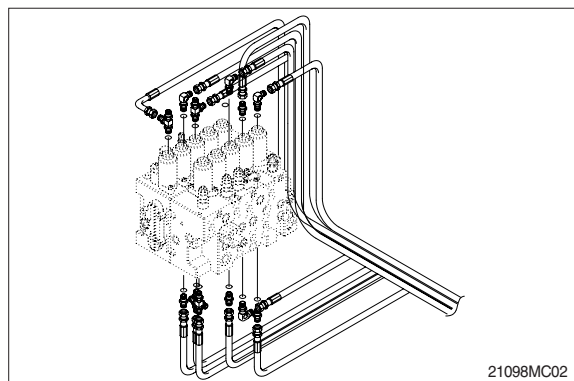
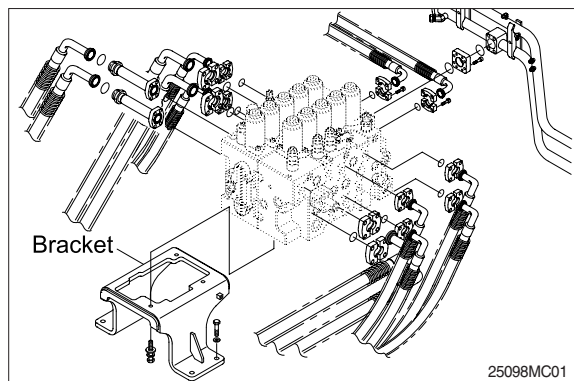

2. STRUCTURE (1/4)

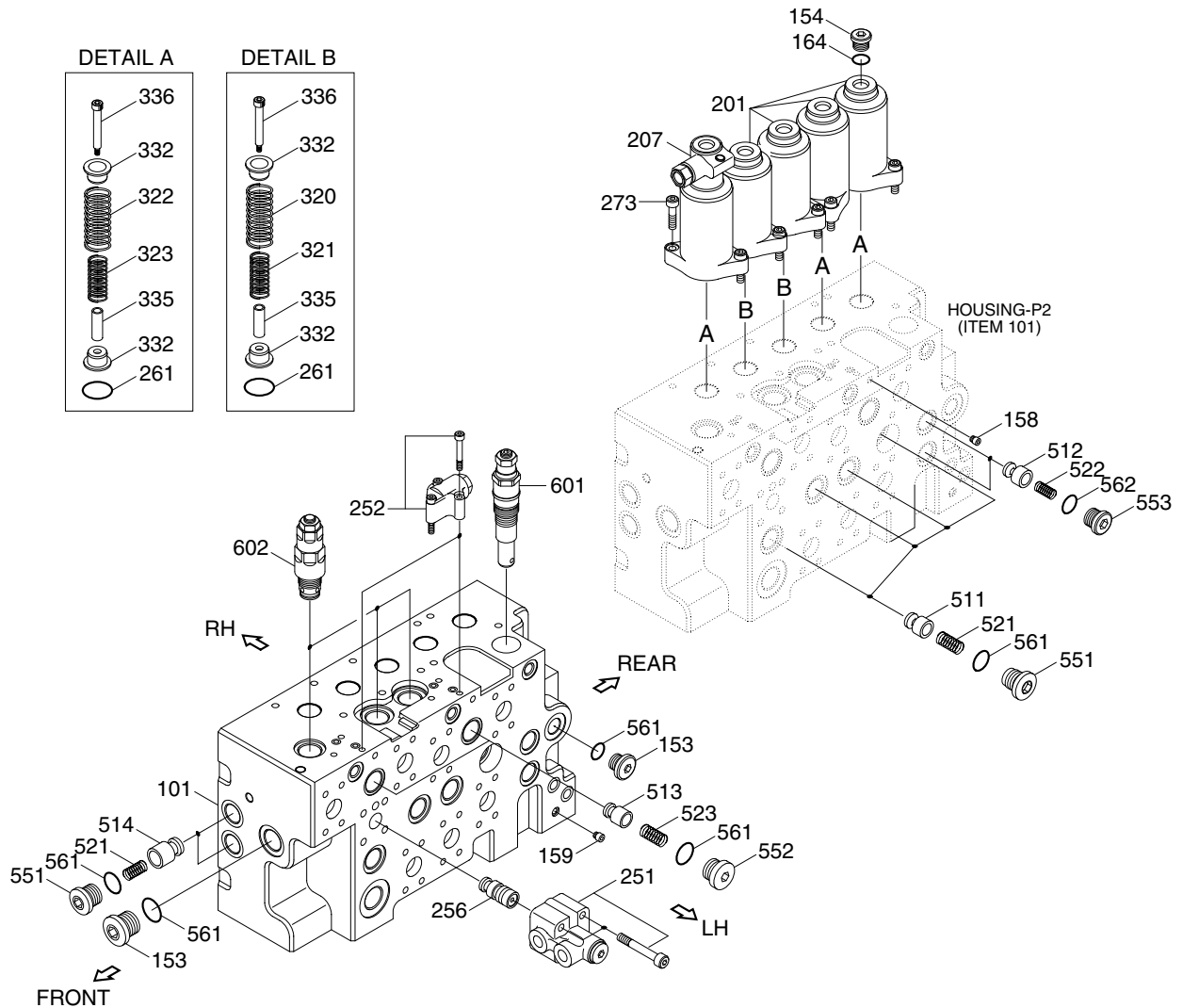

21098MC04

101	P2 housing	273	Socket screw	521	Spring
153	Plug	320	Spring	522	Spring
154	Plug	321	Spring	523	Spring
158	Plug	322	Spring	551	Plug
159	Plug	323	Spring	552	Plug
164	O-ring	332	Seat	553	Plug
201	Spring cover	335	Stopper	561	O-ring
207	Spring cover sub assy	336	Bolt	562	O-ring
251	Logic control valve	511	Poppet	601	Main relief valve
252	Selector lock valve	512	Poppet	602	Port relief valve
256	Logic poppet	513	Poppet		
261	O-ring	514	Poppet		

STRUCTURE (2/4)

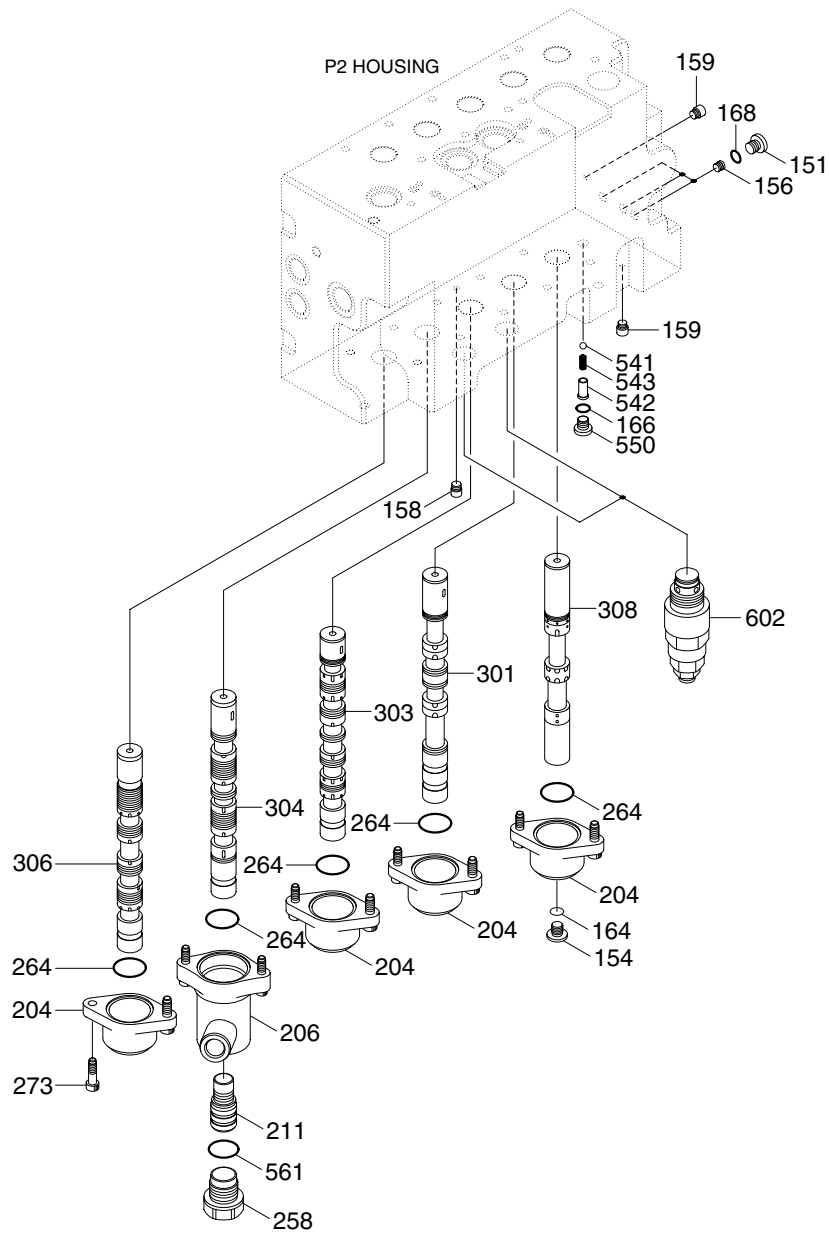

21098MC05

151 Plug	206 Cover	308 Straight travel spool
154 Plug	211 Piston	41 Steel ball
156 Orifice	258 Plug	42 Spring seat
158 Plug	264 O-ring	43 Spring
159 Plug	273 Socket screw	50 Plug
164 O-ring	301 Travel, LH spool	51 O-ring
166 O-ring	303 Boom 1 spool	52 Port relief valve
168 O-ring	304 Bucket spool	
204 Cover	306 Arm 2 spool	

STRUCTURE (3/4)

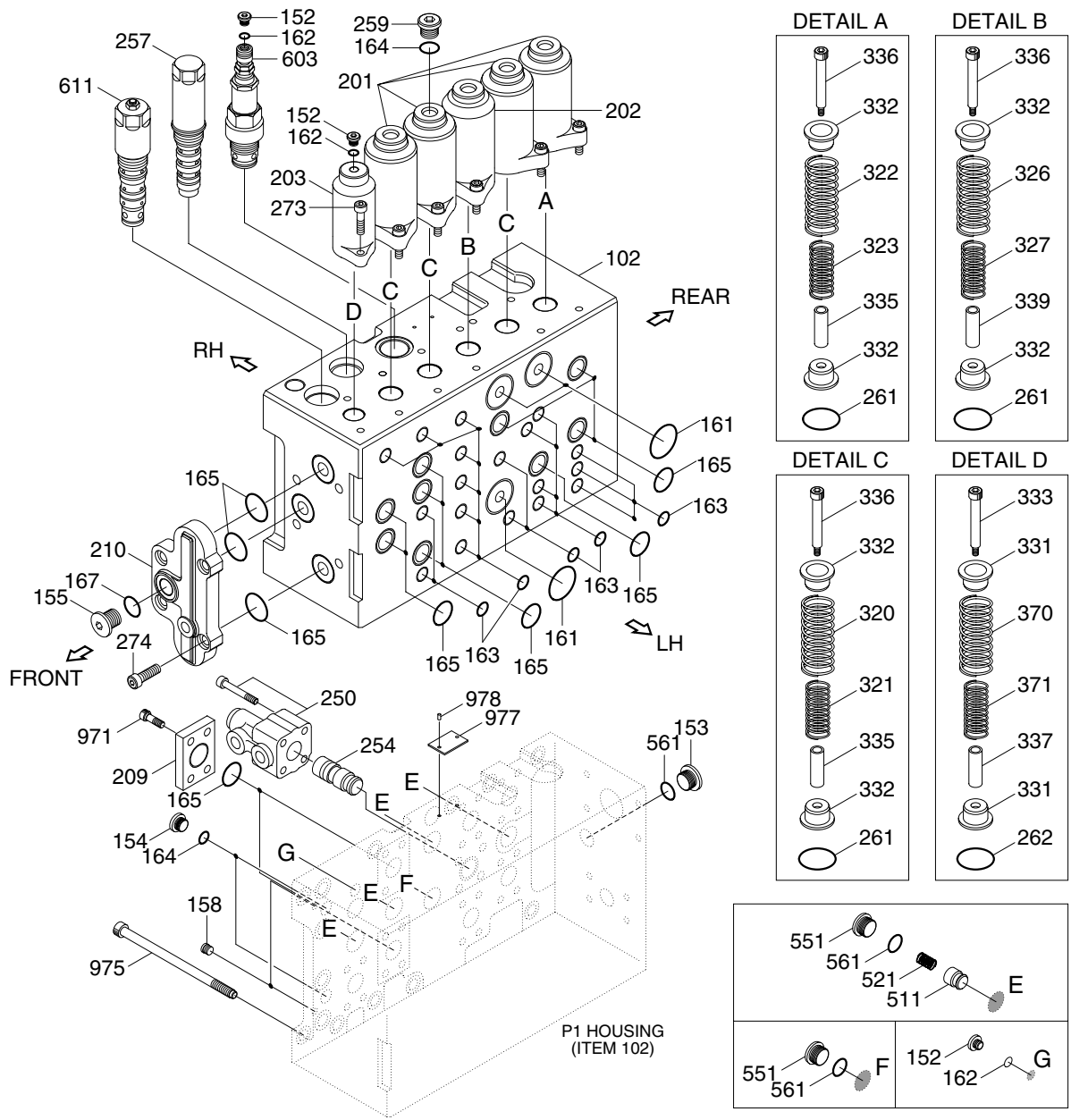

21098MC06

- | | | | |
|----------------|-------------------------|------------------|-----------------------------|
| 102 P1 housing | 201 Spring cover | 274 Socket screw | 337 Stopper |
| 152 Plug | 202 Spring cover | 320 Spring | 339 Stopper |
| 153 Plug | 203 Spring cover | 321 Spring | 370 Spring |
| 154 Plug | 209 Flange | 322 Spring | 371 Spring |
| 155 Plug | 210 Plate | 323 Spring | 511 Poppet |
| 158 Plug | 250 Logic control valve | 326 Spring | 521 Spring |
| 161 O-ring | 254 Logic poppet | 327 Spring | 551 Plug |
| 162 O-ring | 257 Arm regen cut sub | 331 Seat | 561 O-ring |
| 163 O-ring | 259 Plug | 332 Seat | 603 Port relief valve |
| 164 O-ring | 261 O-ring | 333 Spacer bolt | 611 Posi-nega control valve |
| 165 O-ring | 262 O-ring | 335 Stopper | 971 Screw |
| 167 O-ring | 273 Socket screw | 336 Bolt | 975 Socket screw |

STRUCTURE (4/4)

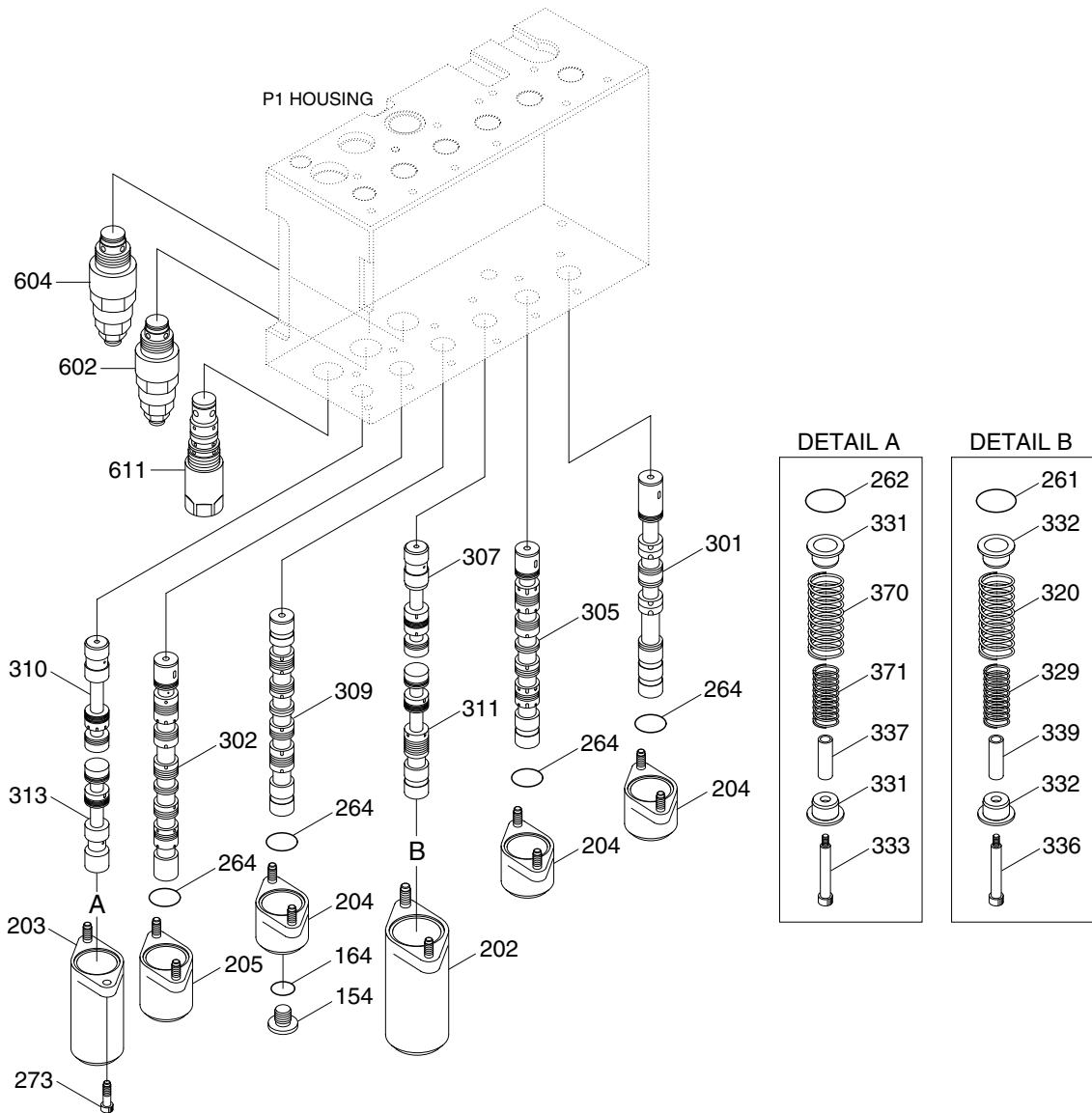

21098MC07

- | | | |
|----------------------|--------------------------|--------------------------------|
| 154 Plug | 302 Arm 1 spool | 333 Spacer bolt |
| 164 O-ring | 305 Swing spool | 336 Bolt |
| 202 Spring cover | 307 Boom 2 spool | 337 Stopper |
| 203 Spring cover | 309 Option spool | 339 Stopper |
| 204 Cover | 310 Bypass cut spool | 370 Spring |
| 205 Cover | 311 Swing priority spool | 371 Spring |
| 261 O-ring | 313 Bypass cut spool | 602 Port relief valve |
| 262 O-ring | 320 Spring | 604 Port relief valve assembly |
| 264 O-ring | 329 Spring | 611 Posi-nega control valve |
| 273 Socket screw | 331 Seat | |
| 301 Travel, LH spool | 332 Seat | |

3. DISASSEMBLY AND ASSEMBLY

1) GENERAL PRECAUTIONS

- (1) All hydraulic components are manufactured to a high precision. Consequently, before disassembling and assembling them, it is essential to select an especially clean place.
- (2) In handling a control valve, pay full attention to prevent dust, sand, etc. from entering into it.
- (3) When a control valve is to be removed from the machine, apply caps and masking seals to all ports. Before disassembling the valve, recheck that these caps and masking seals are fitted completely, and then clean the outside of the assembly. Use a proper bench for working. Spread a paper or rubber mat on the bench, and disassemble the valve on it.
- (4) Support the body section carefully when carrying or transferring the control valve. Do not lift by the exposed spool, end cover section etc.
- (5) After disassembling and assembling of the component it is desired to carry out various tests (for the relief characteristics, leakage, flow resistance, etc.), but hydraulic test equipment is necessary for these tests. Therefore, even when its disassembling can be carried out technically, do not disassemble such components that cannot be tested, adjusted, and so on. Additionally one should always prepare clean cleaning oil, hydraulic oil, grease, etc. before hand.

2) TOOLS

Before disassembling the control valve, prepare the following tools beforehand.

Name of tool	Quantity	Size (mm)
Vice mounted on bench (soft jaws)	1 unit	
Box wrench	Each 1 piece	24, 32, 36
Hexagon key wrench	Each 1 piece	4, 5, 6, 8, 10 and 12
Loctite #262	1 piece	-
Spanner	Each 1 piece	32 (main relief valve, 601) 36 (port relief valve, 603)

3) DISASSEMBLY

The figure in () shown after the part name in the explanation sentence shows its number in the structure figures (8-31~34).

- (1) Place control valve on working bench.
- ※ Disassemble it in clean place and pay attention not to damage flange faces and plate faces.

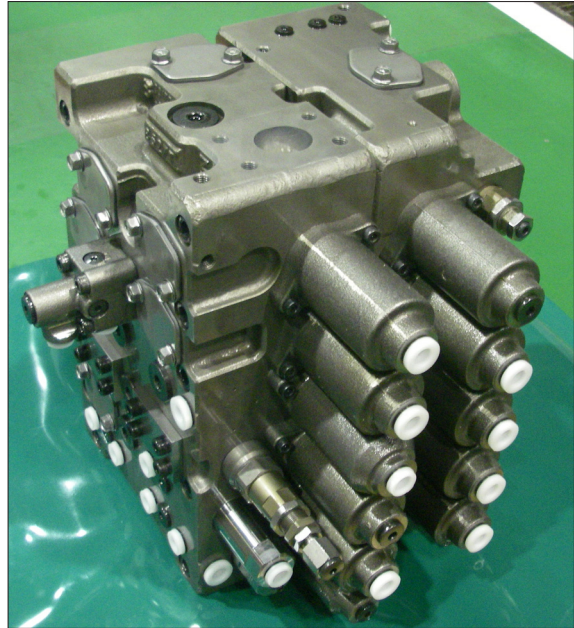

21098MC37

(2) Disassembling of main spools

- Travel (301), bucket (304), swing (305), option (308), arm 2 (306), boom 2 (307), swing priority (311).
- ① Loosen the hexagon the socket head bolts (273) and remove the spring cover (201, 202) and the O-ring (261).
 - Hexagon key wrench : 6 mm

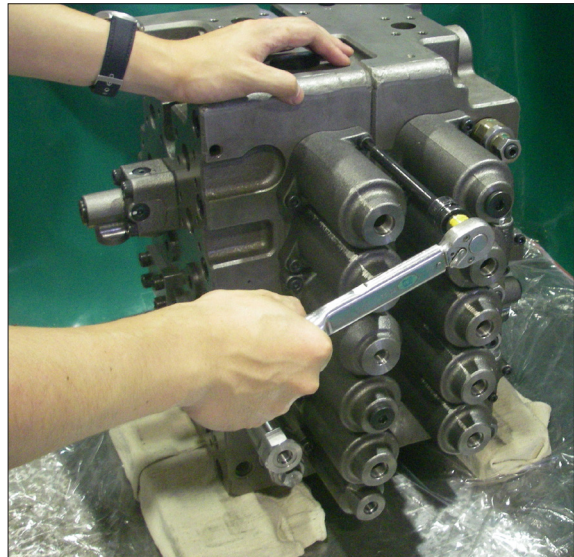

21098MC38

- ② Pull out the spool, spring, spring seats (322), stopper (335 or 339) and spacer bolt (336) in the spool assembly condition from the casing.
- ※ When pulling out the spool assembly from housing, pay attention not to damage the housing.

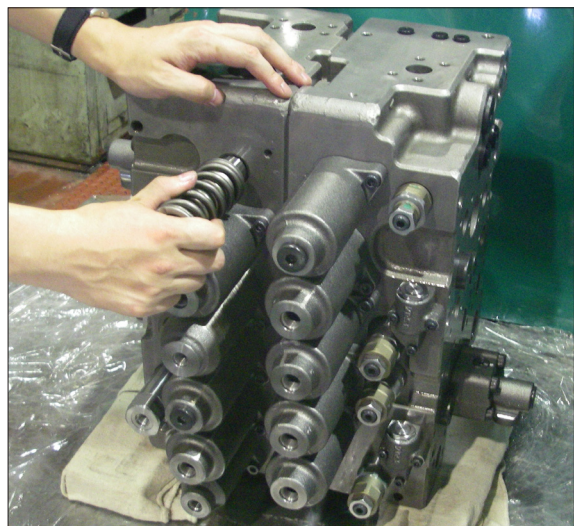

21078MC11

- ③ Hold the spool in the mouthpiece-attached vise applying a protection plate (aluminum plate and the like) in between. Remove the spacer bolt (336) and disassemble the stopper (335 or 339) and spring seats (332).

· Hexagon key wrench : 10 mm



21098MC40

(3) Disassembling of boom 1 spool (303):

- ① Loosen the hexagon socket head bolts (273), and remove the spring cover (201) and the O-ring (261).

· Hexagon key wrench : 6 mm

- ② Pull out the boom 1 spool (303), spring (320, 321), spring seats (332), stopper (335) and spacer bolt (336) in the spool assembly condition from the P2 housing (101).

※ When pulling out the spool assembly from P2 housing (101), pay attention not to damage housing.

- ③ Hold the boom1 spool (303) in the mouthpiece-attached vise applying a protection plate (aluminum plate and the like) in between. Remove the spacer bolt (336), and disassemble the spring (320, 321), spring seats (332) and stopper (335).

· Hexagon key wrench : 10 mm

- ④ Do not disassemble the boom1 spool (303) more than these conditions.

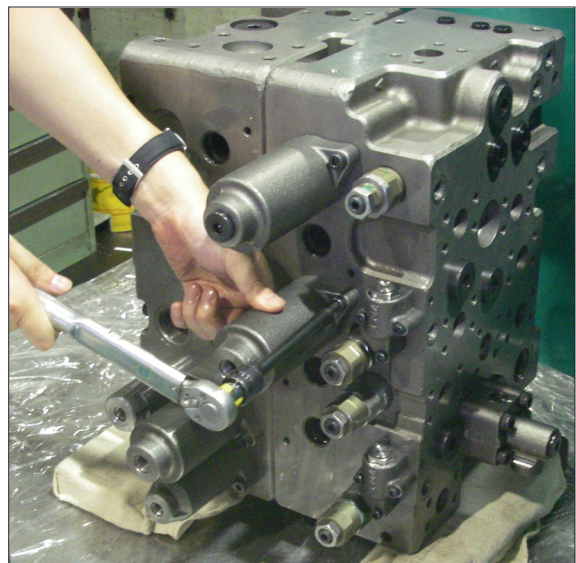

21098MC41

(4) Disassembling of arm 1 spool (302):

- ① Loosen the hexagon socket head bolts (273), and remove the spring cover (201) and the O-ring (261).

· Hexagon key wrench : 6 mm

- ② Pull out the arm 1 spool (302), spring (320, 321), spring seats (332), stopper (335) and spacer bolt (336) in the spool assembly condition from the P1 housing (102).

※ When pulling out the spool assembly from P1 housing(102), pay attention not to damage housing.

- ③ Hold the arm 1 spool (302) in the mouthpiece-attached vise applying a protection plate (aluminum plate and the like) in between. Remove the spacer bolt (336), and disassemble the spring (320, 321), spring seats (332) and stopper (335).

· Hexagon key wrench : 10 mm

- ④ Do not disassemble the arm 1 spool (302) more than these conditions.

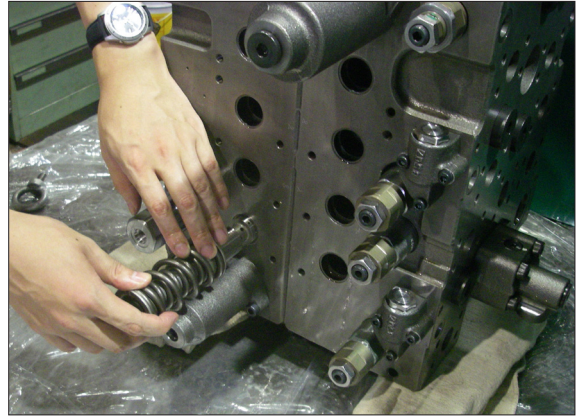

21098MC42

(5) Disassembling of travel straight spool (308):

- ① Loosen the hexagon socket head bolts (273), and remove the spring cover (201) and the O-ring (261).

· Hexagon key wrench : 6 mm

- ② Pull out the travel straight spool (308), spring (322, 323), spring seat (332), stopper (335) and spacer bolt (336) in the spool assembly condition from the P2 housing (101).

※ When pulling out the spool assembly from P2 housing (101), pay attention not to damage housing.

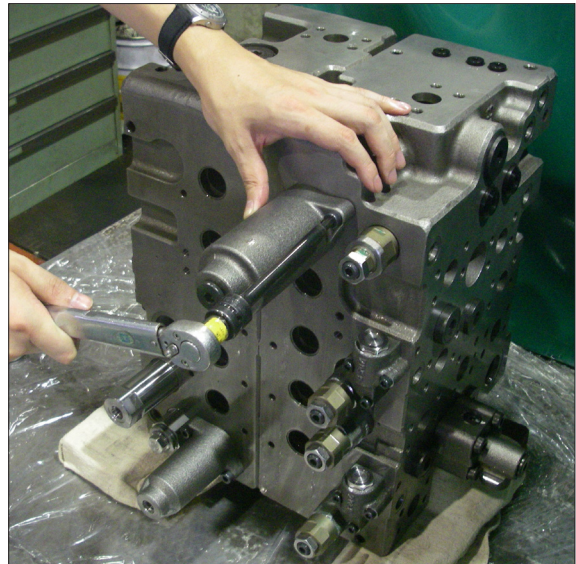

21098MC43

- ③ Hold the travel straight spool (308) in the mouthpiece-attached vise applying a protection plate (aluminum plate and the like) in between. Remove the spacer bolt (336) and disassemble the spring(322, 323), spring seats(332) and stopper (335).
 - Hexagon key wrench : 10 mm
- ④ Do not disassemble the travel straight spool (308) more than these conditions.

(6) Disassembling of bypass cut spool (310, 313):

- ① Loosen the hexagon socket head bolts (273), and remove the spring cover (203) and the O-ring (262).
 - Hexagon key wrench : 6 mm
- ② Pull out the bypass cut spool (310, 313), spring (370, 371), spring seats (331), stopper (337) and spacer bolt (333) in the spool assembly condition from the P1 housing.
- ※ When pulling out the spool assembly from P1 housing (102), pay attention not to damage housing.

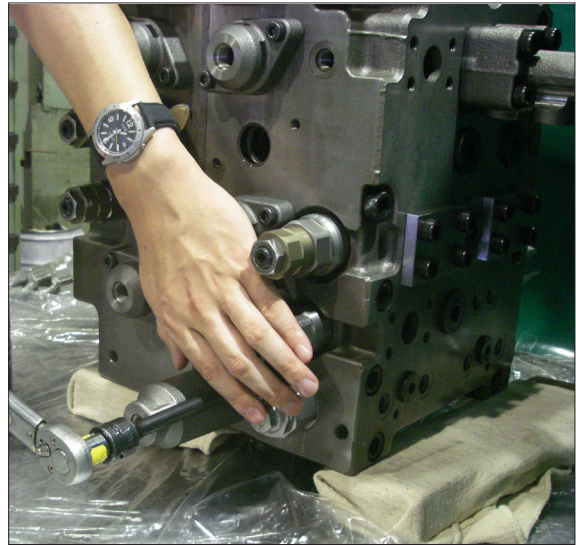

21098MC44

- ③ Hold the bypass cut spool (310,313) in the mouthpiece-attached vise applying a protection plate (aluminum plate and the like) in between. Remove the spacer bolt (333) and disassemble the spring (370, 371), spring seats (331) and stopper (337).
 - Hexagon key wrench : 10 mm



21098MC45

(7) Disassembling of spool covers (204, 205, 206):

- ① Remove the hexagon socket head bolts (273), and remove the spool cover (204, 205, 206) and the O-ring (264).

- Hexagon key wrench : 6 mm

- ② In removing the bucket spool cover (206), at first loosen the plug (258) before it is removed from the P1 housing (102). After removing the bucket spring cover (206) remove the plug (551), and take out the piston (211).

- Box wrench : 32 mm

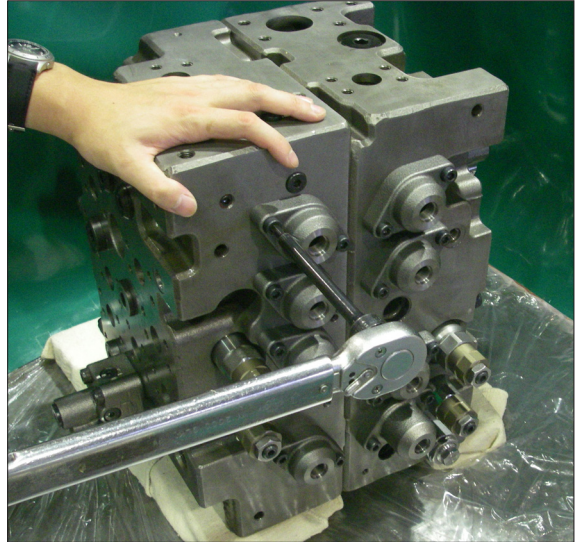

21098MC46

(8) Removal of main relief valve (601) port relief valves (602, 603, 604) :

- ① Remove the main relief valve (601) and the port relief valves (602, 603, 604) from the housing.

Main relief valve (601) : spanner 32mm

Port relief valve (602) : spanner or box wrench 32mm

Port relief valve (603) : spanner 36mm

Port relief valve (604) : spanner or box wrench 36mm

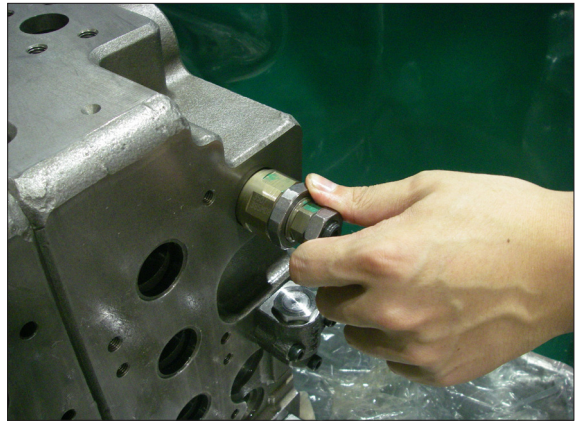

21098MC47

- ② Do not disassemble the relief valves more than these conditions.



21098MC48

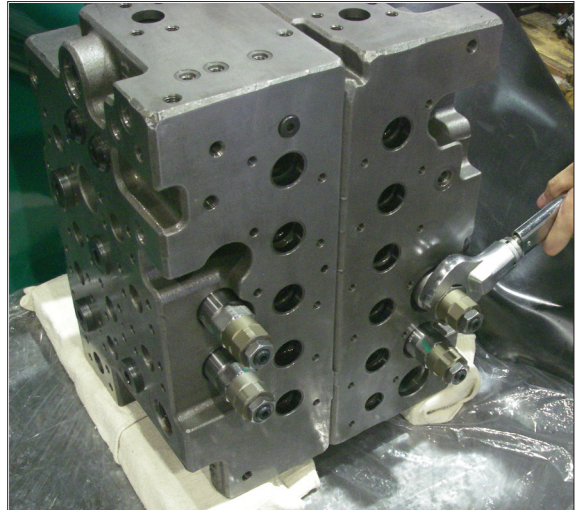

21098MC49

(9) Removal of lock valve selector (252):

- ① Loosen the hexagon socket head bolts (252-171) and remove the lock valve selector (252) and the O-rings (252-161).
 - Hexagon key wrench : 5 mm
- ② Do not disassemble the lock valve selector (252) more than these conditions.

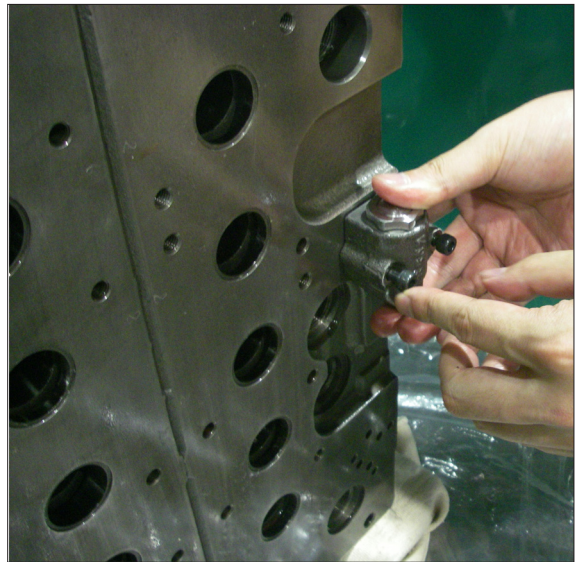

21098MC50

(10) Removal of posi-nega conversion valve (611):

- ① Remove the posi-nega conversion valve (611) from the P1 housing (102).
 - Box wrench : 36 mm
- ② Do not disassemble the posi-nega conversion valve (611) more than these conditions.

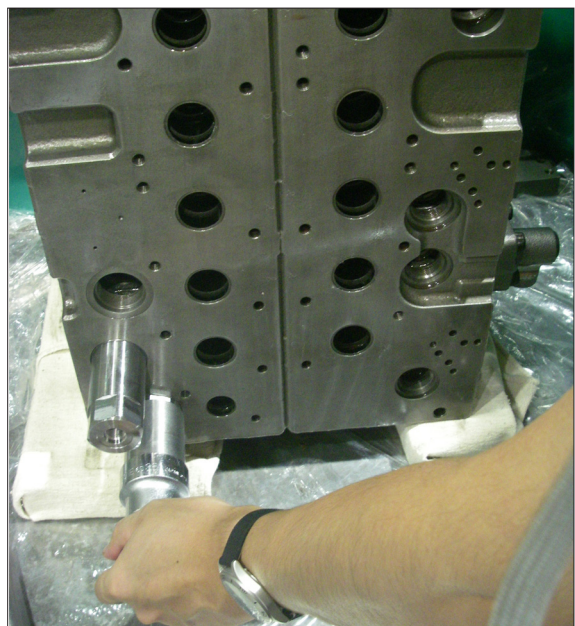

21098MC51

(11) Removal of arm regeneration cut valve (257):

Remove the plug (253), spring (331), spool (211), and sleeve (392) from the P1 housing (102).

- Box wrench : 36 mm

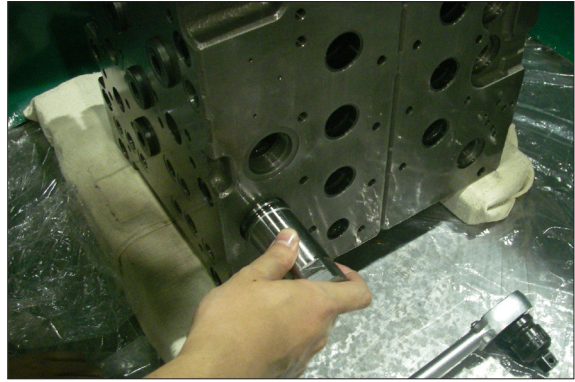

21098MC52

(12) Disassembly of logic control valve (250, 251) and logic poppet (254, 256):

- ① Loosen the hexagon socket head bolts (250-120, 251-120) and remove the logic control valve (250, 251) and the O-rings (250-112 and 113, 251-112 and 113).
 - Hexagon key wrench : 8 mm

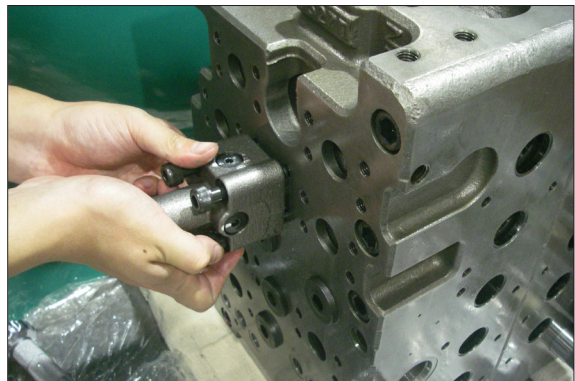

21098MC53

- ② Pull out the logic poppet (254, 256), spring (254-106, 256-106) and spring seat (254-103, 256-103) from the housing.

- ③ Do not disassemble the logic control valve and the logic poppet more than these condition.



21098MC54

(13) Disassembly of check valve :

- ① CP1, C2, CCb, LCb, LCo, Lck, LCa, LCAT2

Remove the plug (551) and take out the poppet (511) and the spring (521).

- Hexagon key wrench : 12 mm

- ② CMR1, CMR2

Remove the plug (553) and take out the poppet (512) and the spring (522).

- Hexagon key wrench : 10 mm

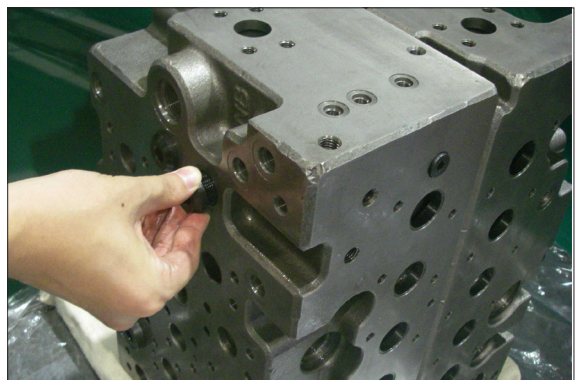

21098MC55

③ CRa, CRb

Remove the plug (552) and take out the poppet (513) and the spring (523).

- Hexagon key wrench : 12 mm

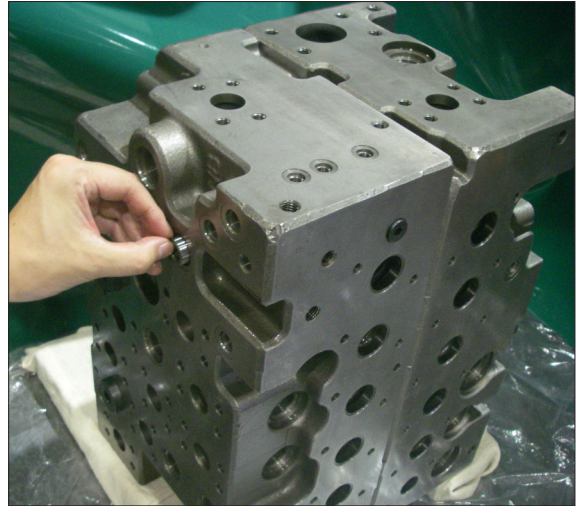

21098MC56

④ CCK, CCo

Remove the plug (551) and take out poppet (514) and the spring (521).

- Hexagon key wrench : 12 mm

⑤ Remove the plug (550) and take out the ball (541), spring (543) and spring seat (542).

- Hexagon key wrench : 6 mm

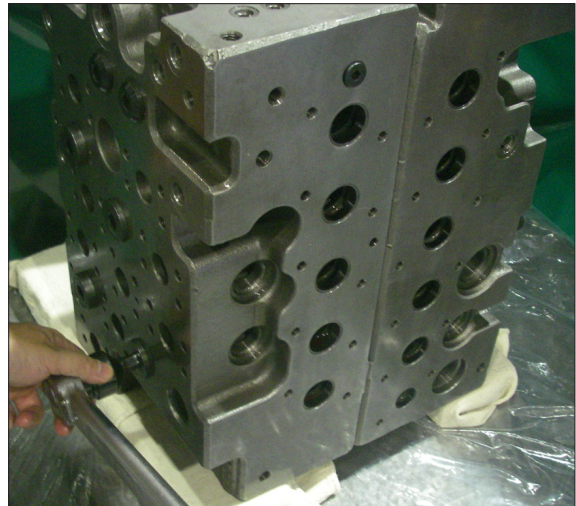

21098MC57

(14) Disassembly of flanges (209) :

Loosen the hexagon socket head bolts (971) and remove the flange (209) and the O-ring (165).

- Hexagon key wrench : 8 mm

(15) Disassembly of plate (210) :

Loosen the hexagon socket head bolts (274) and remove the plate (210) and the O-rings (165).

- Hexagon key wrench : 10 mm

(16) Disassembly of orifices for signal line :

Do not disassemble the plug (151) and orifice (156) unless required specifically.

(17) Disassembly of casing :

- ① Except when required specially, do not disassemble the tie bolts of the P1 housing.
- ② Since the plugs not described in above disassembling procedures are the blind plugs for sacrifice holes and the blind plugs for the housing sanitation, do not disassemble them as far as not required specially.



21098MC58

(18) Inspection after disassembling

Clean all the disassembled parts with clean mineral oil fully, and dry them with compressed air. Then, place them on clean papers or cloths for inspection.

① Control valve

- a. Check whole surfaces of all parts for burrs, scratches, notches and other defects.
- b. Confirm that the seal groove faces of the housing and the covers are smooth and free of dust, dent, rust etc.
- c. Correct dents and damages on check seat faces of housing, if any, by lapping.
※ Pay attention not to leave lapping agent in the housing.
- d. Confirm that all sliding and fitting parts can be moved manually and that all grooves and paths are free from foreign matter.
- e. If any spring is broken or deformed, replace it with new one.
- f. When a relief valve does not function properly, repair it, following its inspection procedures.
- g. Replace all the O-rings with new ones.

② Relief valve

- a. Confirm that all seat faces at ends of all poppets and seats are free of defects and are uniform contact faces.
- b. Confirm manually that main poppet and seat can slide lightly and smoothly.
- c. Confirm that outside face of main poppet and inside face of seat are free from scratches and so on.
- d. Confirm that orifices of the main poppet and seat section are not clogged with foreign matter.
- e. Replace all O-rings with new ones.
- f. When any light damage is found in above inspections, correct it by lapping.
- g. When any abnormal part is found, replace it with a relief valve assembly.

4) ASSEMBLY

- ① In this assembling section, explanation only is shown. Refer to figures and photographs shown in disassembling section.
- ② Figure in () shown after part name in explanation sentence shows number in structure figure.
- ③ Cautions in assembling O-rings
 - a. Pay attention to keep O-rings free from defects in its forming and damages in its handling.
 - b. Apply grease, hydraulic oil or so on to O-rings and seal-fitting sections for full lubrication.
 - c. Do not stretch O-rings so much to deform them permanently.
 - d. In fitting O-ring, pay attention not to roll it into its position. In addition, twisted O-ring cannot remove its twisting naturally with ease after being fitted, and causes oil leakage.
 - e. Tighten fixing the bolts for all sections with a torque wrench to their respective tightening torque.

(1) Assembly of check valve :

- ① Assemble the poppets (511, 512, 513, 514) and the springs (521, 522, 523) : Put the O-rings (561) onto the plugs (551, 552). Put the O-rings (562) onto the plugs (553). Tighten the plugs (551, 552, 553) with their specified torques.

※ Use the poppets, springs and plugs in following groups.

Poppet	Spring	Plug	Remember that
511	521	551	511 in 8 positions
512	522	553	512 in 2 positions
513	523	552	513 in 2 positions
514	521	551	514 in 2 positions

Plug No.	Hexagon key wrench (mm)	Tightening torque (kgf·m)
551	12	23.5 ~ 26.5
552	12	23.5 ~ 26.5
553	10	13.3 ~ 15.3

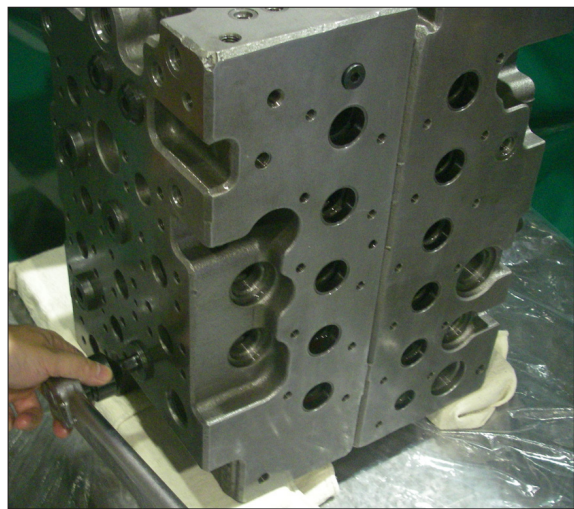

21098MC57

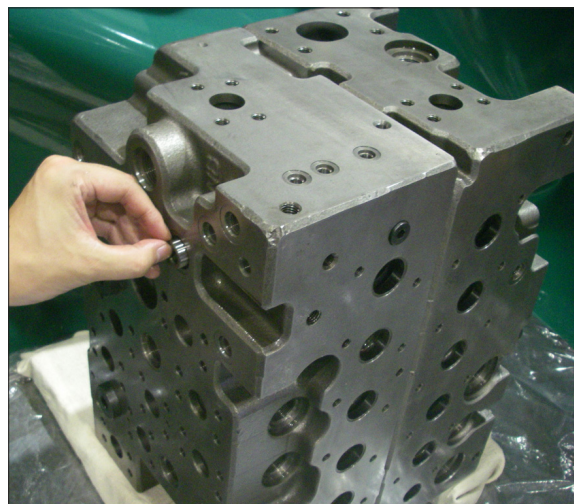

21098MC56

② Assemble of ball (541), spring Seat (542) and spring (543) : Put the O-ring (166) onto the plug (550), and tighten the plug (550) with specified torque.

- Hexagon key wrench : 6 mm
- Tightening torque : 2.55 ~ 2.96 kgf·m
(18.4~21.4 lbf·ft)

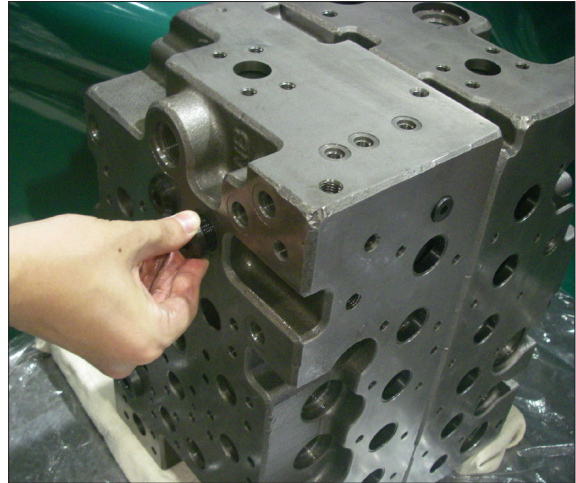

21098MC55

(2) Assembly of plate (210) :

Fit the O-rings (165) to the P1 housing (102), and tighten the hexagon socket head bolts (274) with specified torque.

- Hexagon key wrench : 10 mm
- Tightening torque : 10.0 ~ 12.2 kgf·m
(72.3~88.2 lbf·ft)

So turn the control valve that the plate face may be directed downward.

(3) Assembly of flange (209) :

Fit the O-rings (165) to the flange (209), and tighten the hexagon socket head bolts (971) with specified torque.

- Hexagon key wrench : 8 mm
- Tightening torque : 5.0 ~ 6.6 kgf·m
(36.2~47.7 lbf·ft)

(4) Assemble of logic control valve :

① Put the O-ring (250-115, 251-115) onto the plug (250-111, 251-111).

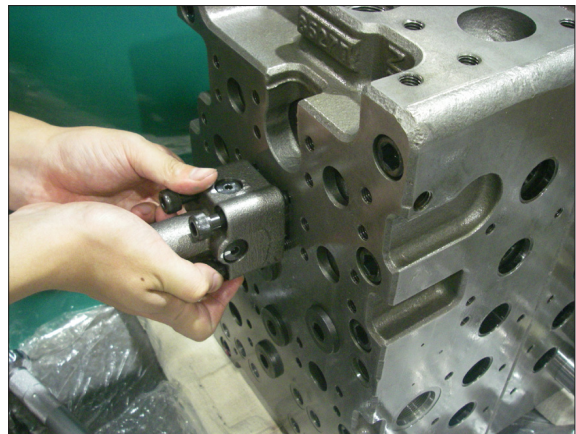

21098MC53

- ② Assemble the spool (250-102, 251-102), spring seat (250-104, 251-104) and spring (251-105, 251-105) into the casing (250-101, 251-101) of the logic control valve, and tighten the plug (250-111, 251-111) with specified torque.

- Hexagon key wrench : 8 mm
- Tightening torque : 7.0 ~ 8.1 kgf·m
(50.6~58.6 lbf·ft)

- ③ Assemble the logic poppet (254; poppet, spring, spring seat) into the housing of the control valve.

- ④ Fit the O-rings (250-112 and 113, 251-112 and 113) to the casing (250-101, 251-101) of the logic control valve, and tighten the hexagon socket head bolts (250-120, 251-120) with specified torque.

- Hexagon key wrench : 8 mm
- Tightening torque : 5.0 ~ 6.6 kgf·m
(36.2~47.7 lbf·ft)

(5) Assembling of posi-nega conversion valve (611) :

Assemble the posi-nega conversion valve (611) into the P2 housing (101), and tighten it with specified torque.

- Box wrench : 36 mm
- Tightening torque : 7.0 ~ 8.0 kgf·m
(50.6~57.9 lbf·ft)

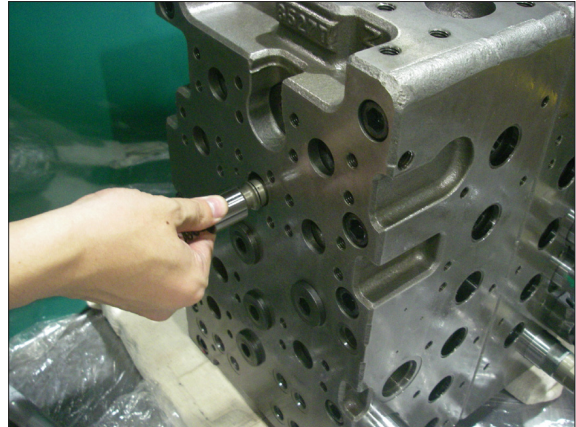

21098MC54

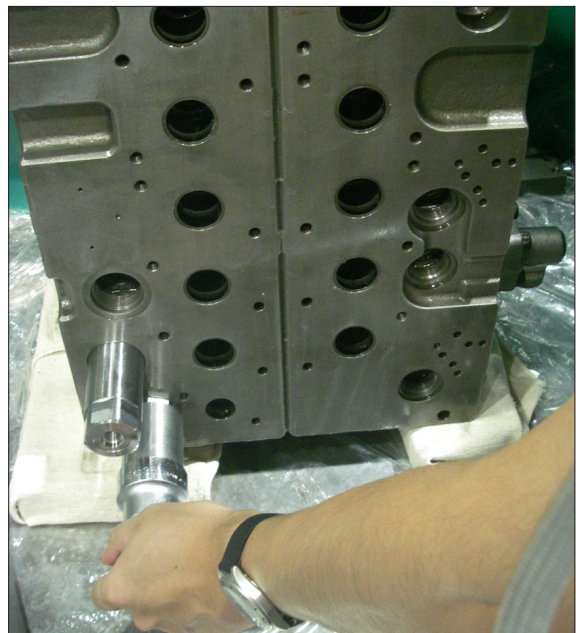

21098MC51

(6) Assembly of arm regeneration cut valve (257) :

Assemble the sleeve (257-212), spool (257-211), and spring (257-231) into the P1 housing (102). Put the O-ring (265) onto the plug (257-253), and tighten with specified torque.

- Box wrench : 36 mm
- Tightening torque : 7.0 ~ 8.0 kgf·m
(50.6~57.9 lbf·ft)

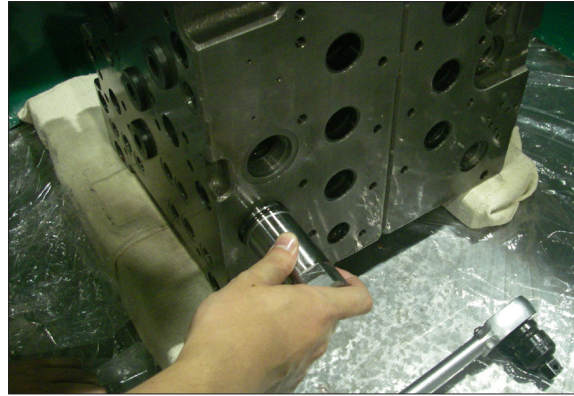

21098MC52

(7) Assembling of lock valve selector (252) :

Fit the O-rings (252-161) to the lock valve selector (252) and tighten the hexagon socket head bolts (252-171) with specified torque.

- Hexagon key wrench : 5 mm
- Tightening torque : 1.0 ~ 1.4 kgf·m
(7.2~10.1 lbf·ft)

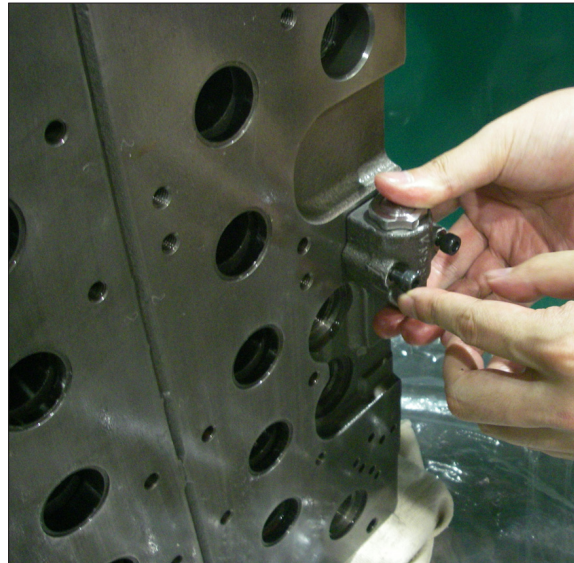

21098MC50

(8) Assembling of main relief valve (601) and port relief valve (602, 603, 604) :

Assemble the main relief valve (601) and the port relief valves (602, 603, 604) to the housing, and tighten them with specified torque.

Item	Tool	Tightening torque (kgf·m)
Main relief valve (601)	Spanner 32	7.0 ~ 8.1
Port relief valve (602)	Spanner 32 or box wrench 32	7.0 ~ 8.1
Port relief valve (603)	Spanner 36	12.2 ~14.3
Port relief valve (604)	Spanner 36 or box wrench 36	12.2 ~14.3

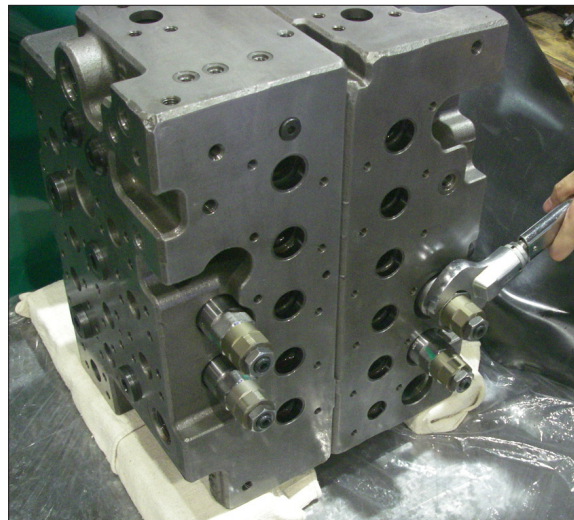

21098MC49

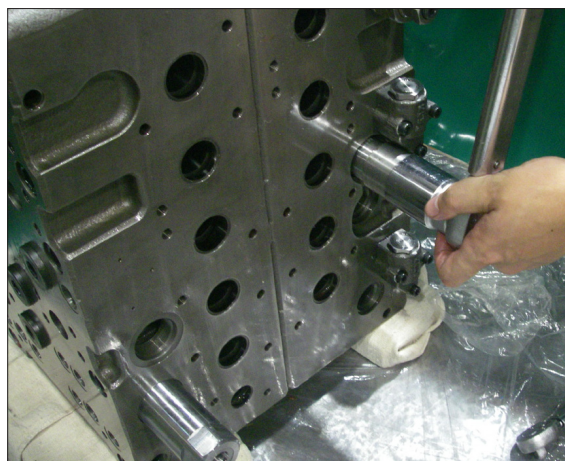

21098MC48

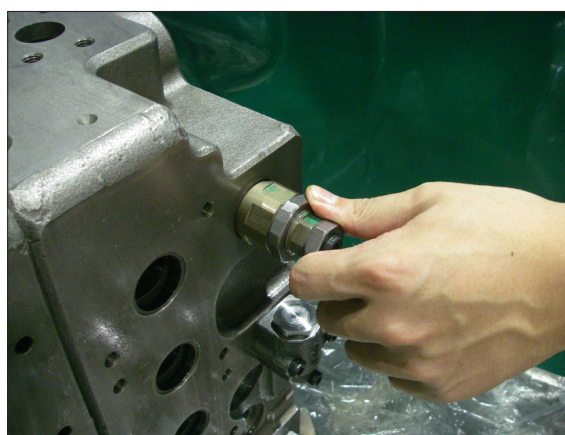

21098MC47

(9) Assemble of travel straight spool (308) :

- ① Hold the middle of the travel straight spool (308) in the mouthpiece-attached vise applying a protection plate (aluminum plate and the like) in between. Attach the spring seats (332), springs (322, 323) and stopper (335), and tighten the spacer bolt (336) with specified torque.

- ※ Before tightening the spacer bolt (336), apply loctite #262 to it.

- Hexagon key wrench : 10 mm
- Tightening torque : 1.6 ~ 1.8 kgf·m
(11.6~13.0 lbf·ft)

- ※ Pay attention not to fasten the vise excessively to the shape of the travel straight spool (308) is deformed.

- ② Insert the spool assemblies of ① items above into the P2 housing (101).

- ※ Fit spool assemblies into P2 housing (101) carefully and slowly.

- ※ Do not push them forcibly without fail.

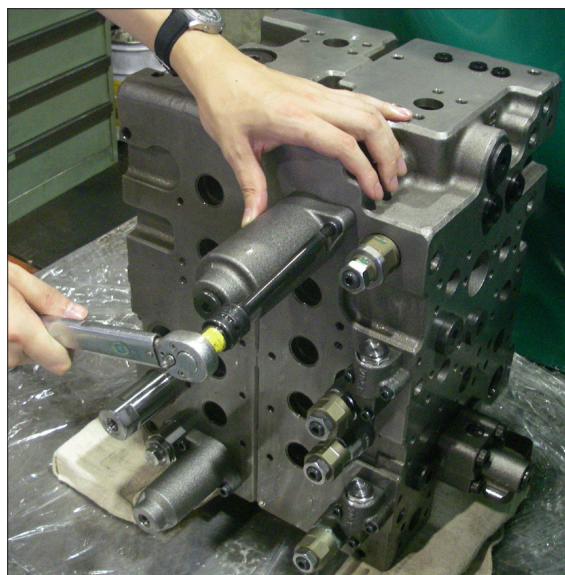

21098MC43

(10) Assembling of boom 1 spool (303) :

- ① Hold the middle of the boom1 spool (303) in the mouthpiece-attached vise applying a protection plate (aluminum plate and the like) in between. Attach the spring seats (332), springs (320, 321) and stopper (335), and tighten the spacer bolt (336) with specified torque.
 - ※ Before tightening the spacer bolt (336), apply loctite #262 to it.
 - Hexagon key wrench : 10 mm
 - Tightening torque : 1.6 ~ 1.8 kgf·m
(11.6~13.0 lbf·ft)
 - ※ Pay attention not to fasten the vise excessively to the shape of the boom 1 spool (303) is deformed.
- ② Insert the spool assemblies of items ① above into the P2 housing (101).
 - ※ Fit spool assemblies into the P2 housing (101) carefully and slowly.
 - ※ Do not push them forcibly without fail.

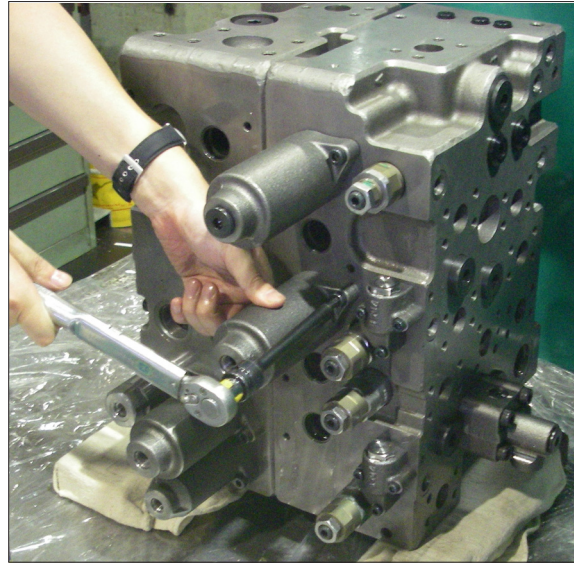

21098MC41

(11) Assembling of arm 1 spool (302) :

- ① Hold the middle of the arm1 spool (302) in the mouthpiece-attached vise applying a protection plate (aluminum plate and the like) in between. Attach the spring seats (332), springs (320, 321) and stopper (335) and tighten the spacer bolt (336) with specified torque.
 - ※ Before tightening the spacer bolt (336), apply loctite #262 to it.
 - Hexagon key wrench : 10 mm
 - Tightening torque : 1.6 ~ 1.8 kgf·m
(11.6~13.0 lbf·ft)
 - ※ Pay attention not to fasten the vise excessively to the shape of the arm 1 spool (302) is deformed.
- ② Insert the spool assemblies of items ① above into the P1 housing (102).
 - ※ Fit spool assemblies into the P1 housing (102) carefully and slowly.
 - ※ Do not push them forcibly without fail.

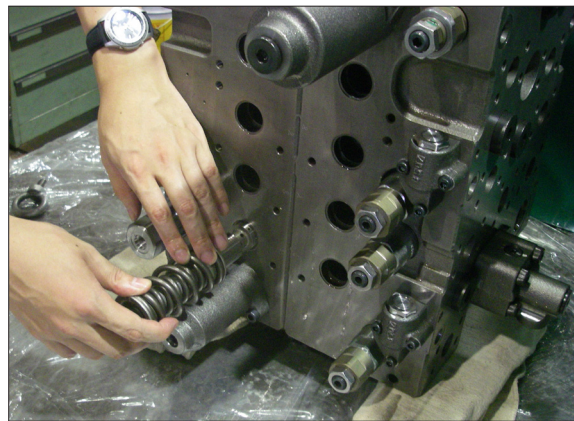

21098MC42

(12) Assembling of main spool (travel (301), bucket (304), swing (305), option (309), arm2 (306), boom2 (307), swing priority (311)):

① Hold the middle of each spool in the mouthpiece-attached vise applying a protection plate (aluminum plate and the like) in between. Attach the spring seats (332), springs and stopper (335 or 339) and tighten the spacer bolt (336) with specified torque.

※ Before tightening the spacer bolt (336), apply loctite #262 to it.

- Hexagon key wrench : 10 mm
- Tightening torque : 1.6 ~ 1.8 kgf·m
(11.6~13.0 lbf·ft)

※ Pay attention not to fasten the vise excessively to the shape of the spool is deformed.

② Insert the spool assemblies of Items ① above into the P2 housing (101) and P1 housing (102).

※ Fit spool assemblies into P2 housing (101) and P1 housing (102) carefully and slowly.

※ Do not push them forcibly without fail.

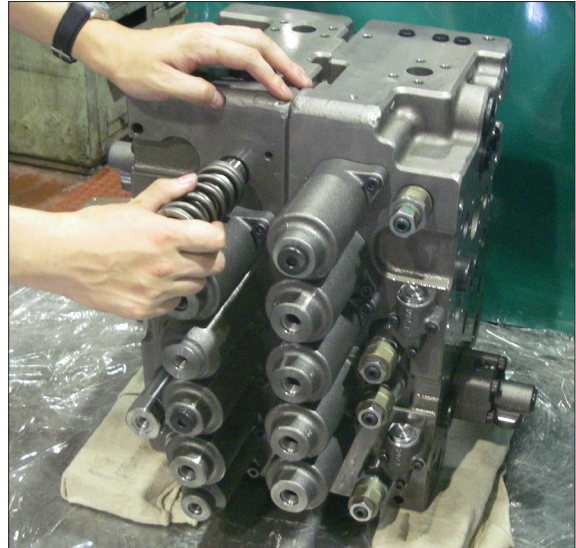

21098MC39



21098MC38

(13) Assembling of bypass cut spool (310, 313) :

- ① Hold the middle of each spool in the mouthpiece-attached vise applying a protection plate (aluminum plate and the like) in between. Attach the spring seats (331), springs (370, 371) and stopper (337) and tighten the spacer bolt (333) with specified torque.
 - ※ Before tightening the spacer bolt (333), apply loctite #262 to it.
 - Hexagon key wrench : 10 mm
 - Tightening torque : 1.6 ~ 1.8 kgf·m
(11.6~13.0 lbf·ft)
 - ※ Pay attention not to fasten the vise excessively to the shape of the bypass cut spool (310, 313) is deformed.
- ② Insert the spool assemblies of Items ① above into the P1 housing (102).
 - ※ Fit spool assemblies into the P1 housing (102) carefully and slowly.
 - ※ Do not push them forcibly without fail.

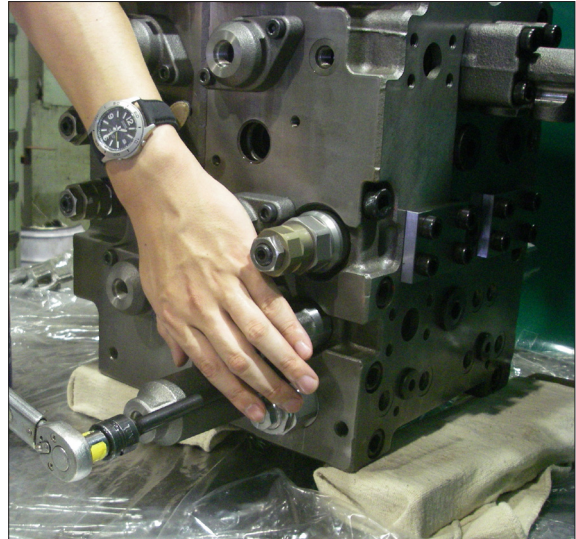

21098MC44

(14) Assembling of covers :

- ① Fit the O-rings (264) to the spool covers (204, 205, 206) to sides reverse to the spring sides of spools, and tighten the hexagon socket head bolts (273) with specified torque.
 - ※ Confirm that O-rings (264) have been fitted to the spool covers (204, 205, 206).
 - Hexagon key wrench : 6 mm
 - Tightening torque : 2.5 ~ 3.5 kgf·m
(18.1~25.3 lbf·ft)
- ② Bucket spool cover (206) : Assemble piston (355) into bucket spool cover (206). Put O-ring (561) onto plug (258) and tighten it with specified torque.
 - Box wrench : 32 mm
 - Tightening torque : 15.3 ~ 18.4 kgf·m
(111~133 lbf·ft)
- ③ Fit the O-rings (261, 262) to spring covers (201, 202, 203) to the spring sides of spools, and tighten the hexagon socket head bolts (273) with specified torque.
 - ※ Confirm that O-rings (261,262) have been fitted to spring covers (204, 205, 206).
 - Hexagon key wrench : 6 mm
 - Tightening torque : 2.5 ~ 3.5 kgf·m
(18.1~25.3 lbf·ft)

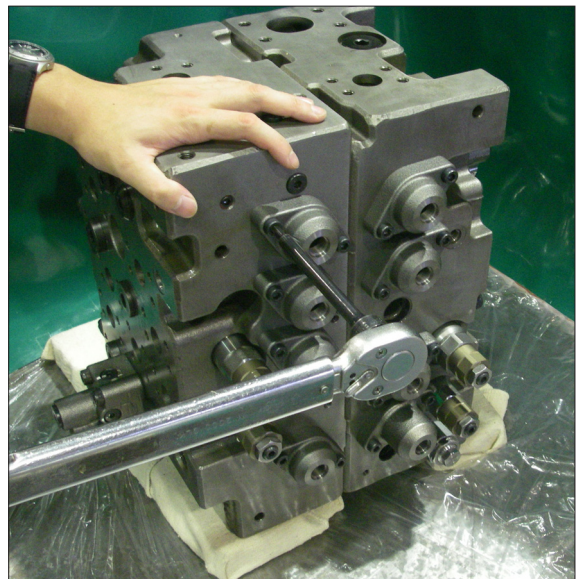

21098MC46