

GROUP 2 MAIN CIRCUIT

The main hydraulic circuit consists of suction circuit, delivery circuit, return circuit and drain circuit. The hydraulic system consists of one main pump, one control valve, one swing motor, four cylinders and two travel motors.

The swash plate type variable displacement axial piston pump is used as the main pump and is driven by the engine at ratio 1.0 of engine speed.

1. SUCTION AND DELIVERY CIRCUIT

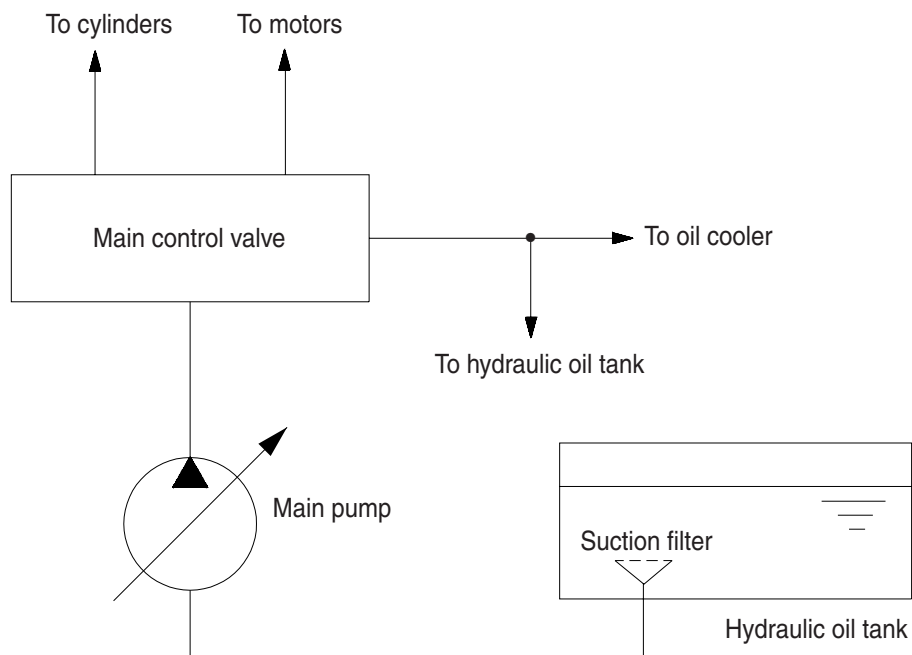

(210-7) 3-03

The pumps receive oil from the hydraulic tank through a suction filter. The discharged oil from the pump flows into the control valve and goes out the tank ports.

The oil discharged from the main pump flows to the actuators through the main control valve.

The main control valve controls the hydraulic functions.

The return oil from the actuators flows to the hydraulic tank through the main control valve and the oil cooler.

2. RETURN CIRCUIT

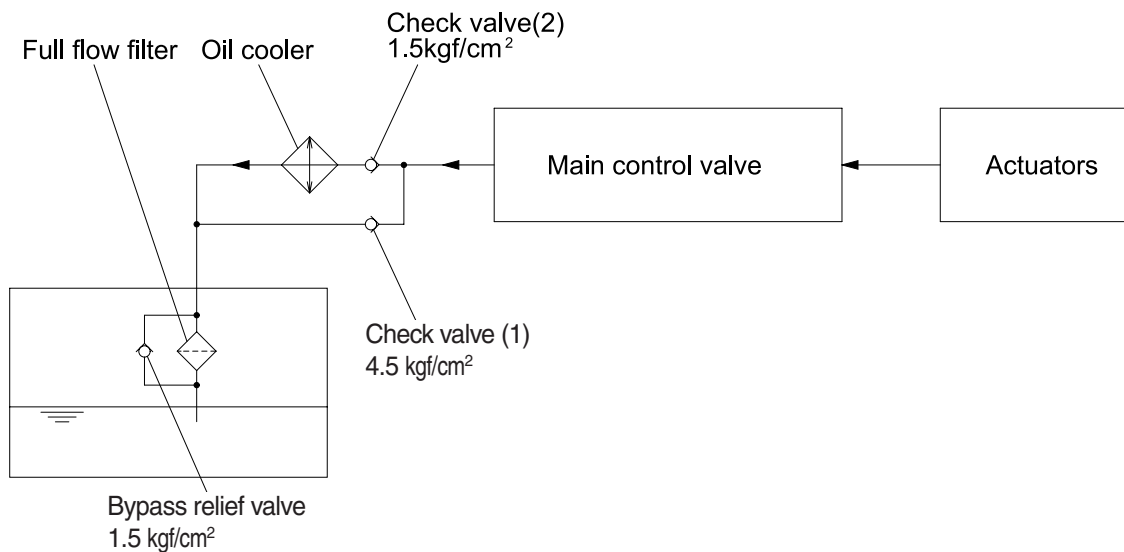

25093CI01

All oil returned from each actuator returns to the hydraulic tank through the main control valve.

The bypass check valves are provided in the return circuit.

The setting pressure of bypass check valves are 1.5 kgf/cm² (21psi) and 4.5 kgf/cm² (64psi). Usually, oil returns to the hydraulic tank from the left side of control valve through oil cooler.

When oil temperature is low, viscosity becomes higher and flow resistance increases when passing through the oil cooler. When the oil pressure exceeds 4.5 kgf/cm² (64psi), the oil returns directly to the hydraulic tank, resulting in the oil temperature being raised quickly at an appropriate level.

When the oil cooler is clogged, the oil returns directly to the hydraulic tank through bypass check valve (1).

The full-flow filter and bypass relief valve are provided in the hydraulic tank.

The oil returned from right and left side of control valve is combined and filtered by the full-flow filter. A bypass relief valve is provided in the full-flow filter.

When the filter element is clogged, the bypass relief valve opens at 1.5 kgf/cm² (21psi) differential pressure.

3. DRAIN CIRCUIT

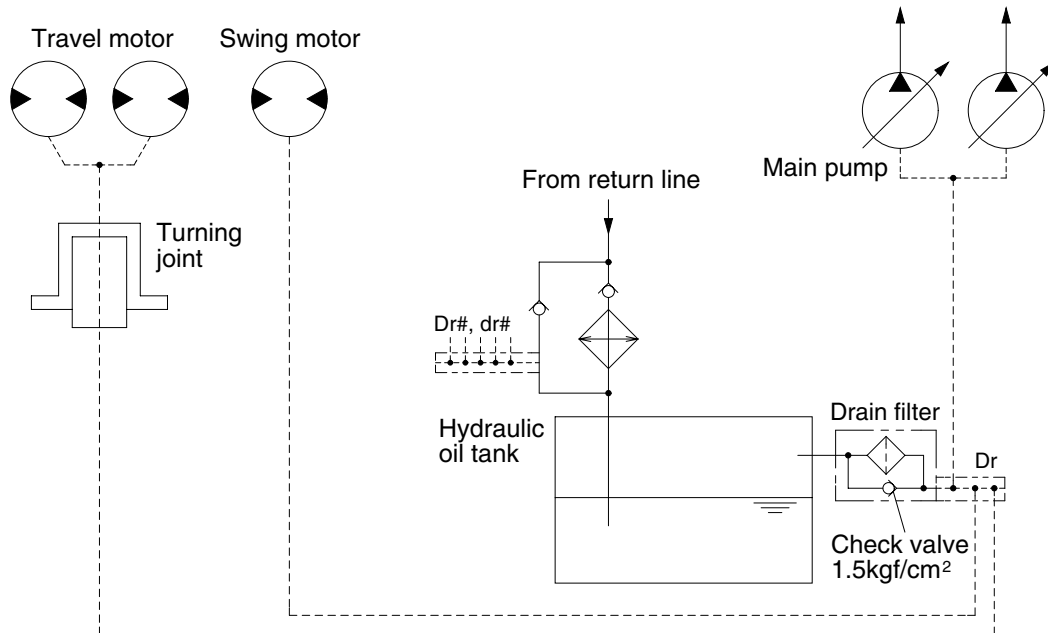

21093CI02

Besides internal leaks from the motors and main pump, the oil for lubrication circulates. These oil have to be fed to the hydraulic tank passing through drain filter.

When the drain oil pressure exceed 1.5 kgf/cm^2 (21psi), the oil returns to the hydraulic tank directly.

1) TRAVEL MOTOR DRAIN CIRCUIT

Oil leaked from the right and left travel motors comes out of the drain ports provided in the respective motor casing and join with each other. These oils pass through the turning joint and return to the hydraulic tank after being filtered by drain filter.

2) SWING MOTOR DRAIN CIRCUIT

Oil leaked from the swing motor returns to the hydraulic tank passing through a drain filter.

3) MAIN PUMP DRAIN CIRCUIT

Oil leaked from main pump returns to the hydraulic tank passing through drain filter.