

GROUP 6 AUTOMATIC WARMING UP SYSTEM

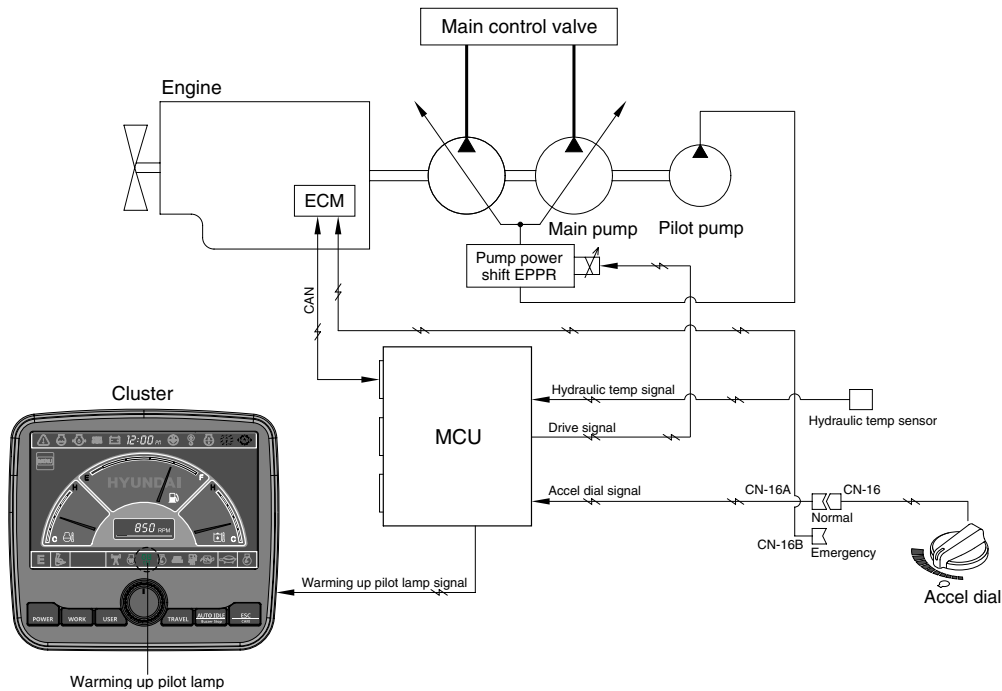

21095MS08

1. The MCU receives the engine coolant temperature from the ECM, and if the coolant temperature is below 30°C, it increases the engine speed from key start rpm to 1200rpm. At this time the mode does not change. If the coolant temperature sensor has fault, the hydraulic oil temperature signal is substituted.
2. In case of the coolant temperature increases up to 30°C, the engine speed is decreased to key start speed. And if an operator changes power mode set during the warming up function, the MCU cancels the automatic warming up function.

3. LOGIC TABLE

Description	Condition	Function
Actuated	- Coolant temperature : below 30°C (after engine run)	- Power mode : Default (E mode) - Warming up time : 10 minutes (max) - Warming up pilot lamp : ON
Canceled	- Coolant temperature : Above 30°C - Warming up time : Above 10 minutes - Changed power mode set by operator - RCV lever or pedal operating - Auto idle cancel ※ If any of the above conditions is applicable, the automatic warming up function is canceled	- Power mode : set mode - Warming up pilot lamp : OFF