

GROUP 2 MAJOR COMPONENT

1. MAIN PUMP

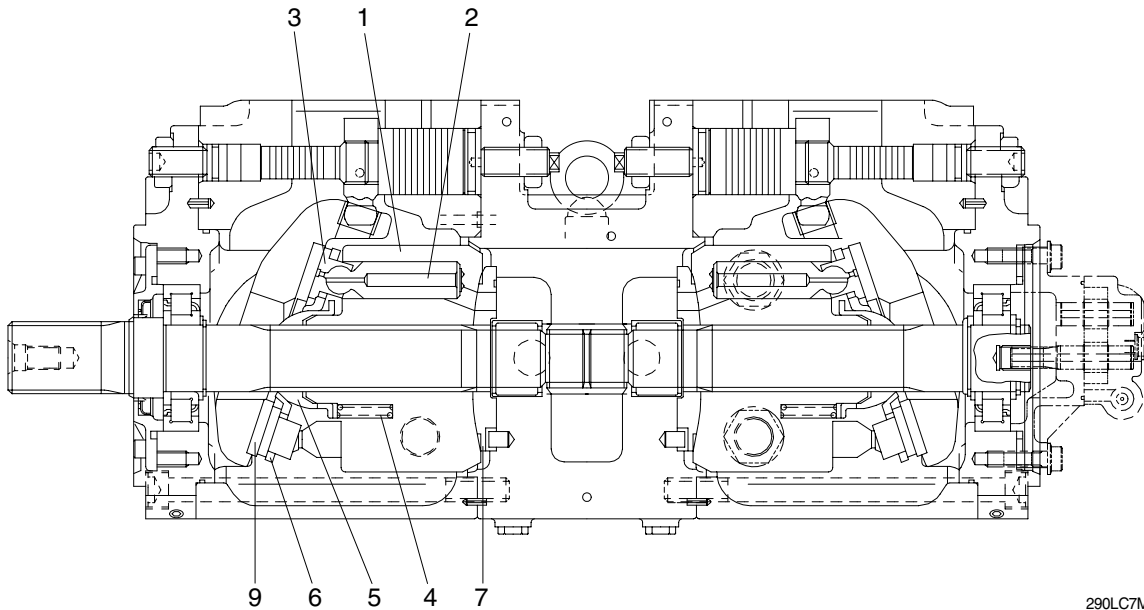

290LC7MS08

Part name & inspection item		Standard dimension	Recommended replacement value	Counter measures
Clearance between piston(1) & cylinder bore(2) (D-d)		0.039	0.067	Replace piston or cylinder.
Play between piston(1) & shoe caulking section(3) (δ)		0-0.1	0.3	Replace assembly of piston & shoe.
Thickness of shoe (t)		4.9	4.7	
Free height of cylinder spring(4) (L)		41.1	40.3	Replace cylinder spring.
Combined height of set plate(5) & spherical bushing(6) (H-h)		23.0	22.0	Replace retainer or set plate.
Surface roughness for valve plate(Sliding face)(7,8), swash plate (shoe plate area)(9), & cylinder(2)(Sliding face)	Surface roughness necessary to be corrected	3z		Lapping
	Standard surface roughness (Corrected value)	0.4z or lower		

2. MAIN CONTROL VALVE

Part name	Inspection item	Criteria & measure
Casing	<ul style="list-style-type: none"> · Existence of scratch, rusting or corrosion. 	<ul style="list-style-type: none"> · In case of damage in following section, replace part. - Sliding sections of casing fore and spool, especially land sections applied with holded pressure. - Seal pocket section where spool is inserted. - Seal section of port where O-ring contacts. - Seal section of each relief valve for main, travel, and port. - Other damages that may damage normal functions.
Spool	<ul style="list-style-type: none"> · Existence of scratch, gnawing, rusting or corrosion. · O-ring seal sections at both ends. · Insert spool in casing hole, rotate and reciprocate it. 	<ul style="list-style-type: none"> · Replacement when its outside sliding section has scratch(Especially on seals-contacting section). · Replacement when its sliding section has scratch. · Correction or replacement when O-ring is damaged or when spool does not move smoothly.
Poppet	<ul style="list-style-type: none"> · Damage of poppet or spring · Insert poppet into casing and function it. 	<ul style="list-style-type: none"> · Correction or replacement when sealing is incomplete. · Normal when it can function lightly without being caught.
Around spring	<ul style="list-style-type: none"> · Rusting, corrosion, deformation or breaking of spring, spring seat, plug or cover. 	<ul style="list-style-type: none"> · Replacement for significant damage.
Around seal for spool	<ul style="list-style-type: none"> · External oil leakage. · Rusting, corrosion or deformation of seal plate. 	<ul style="list-style-type: none"> · Correction or replacement. · Correction or replacement.
Main relief valve, port relief valve & negative control relief valve	<ul style="list-style-type: none"> · External rusting or damage. · Contacting face of valve seat. · Contacting face of poppet. · Abnormal spring. · O-rings, back up rings and seals. 	<ul style="list-style-type: none"> · Replacement. · Replacement when damaged. · Replacement when damaged. · Replacement. · 100% replacement in general.
Balance plate	<ul style="list-style-type: none"> · Worn less than 0.03mm · Worn more than 0.03mm · Sliding surface has a seizure(Even through small). 	<ul style="list-style-type: none"> · Lapping · Replace · Replace

3. SWING DEVICE

1) WEARING PARTS

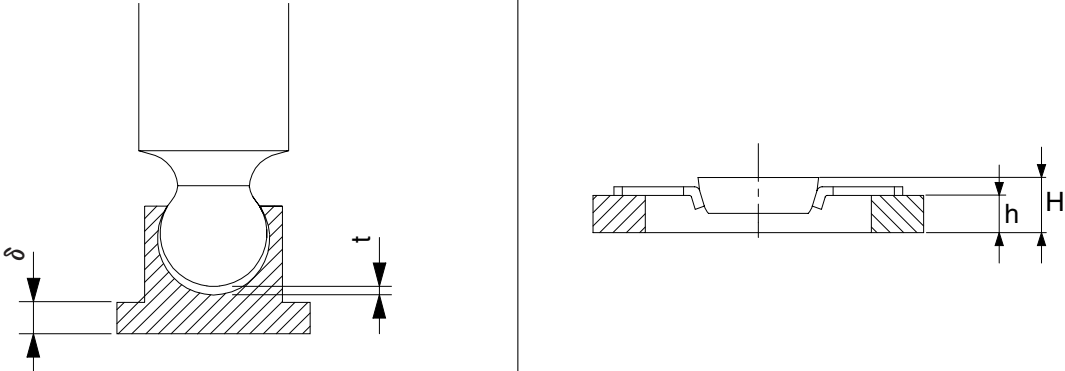
Inspection item	Standard dimension	Recommended replacement value	Counter measures
Clearance between piston and cylinder block bore	0.028	0.058	Replace piston or cylinder block
Play between piston and shoe caulking section(δ)	0	0.3	Replace assembly of piston and shoe
Thickness of shoe(t)	5.5	5.3	Replace assembly of piston and shoe
Combined height of retainer plate and spherical bushing (H-h)	6.5	6.0	Replace set of retainer plate and spherical bushing
Thickness of friction plate	4.0	3.6	Replace
			

2) SLIDING PARTS

Part name	Standard roughness	Allowable roughness	Remark
Shoe	0.8-Z(Ra=0.2) (LAPPING)	3-Z(Ra=0.8)	
Shoe plate	0.4-Z(Ra=0.1) (LAPPING)	3-Z(Ra=0.8)	
Cylinder	1.6-Z(Ra=0.4) (LAPPING)	12.5-Z(Ra=3.2)	
Valve plate	0.8-Z(Ra=0.2) (LAPPING)	6.3-Z(Ra=1.6)	

4. TRAVEL DEVICE

Disassembling and inspection of the motor must be done in strict accordance with the servicing standards described here. During servicing, handle each part very carefully not to damage them, especially for their movable or sliding sections.

1) SEALS

Once the seals(O-rings, oil seals, and floating seals) have been disassembled, they must be replaced with new ones even if no damage is observed.

2) TABLE OF MAINTENANCE STANDARD

(1) Replace all parts having a seriously damaged appearance.

(2) Replace the part if any one of the states(Symptoms) listed in the table below is observed.

Item No.	Part name	Situation	Standard dimension	Maximum allowable value(Criteria)
2 8 17	Spindle kit · Spindle assembly · · Spindle · · Coupling gear · Pin	· Seriously damaged in appearance. · Galling or other forms of excessive wear are observed.	-	-
3 6 9 14 25 34	Carrier assembly Carrier Cluster gear Shaft Thrust collar Needle bearing Parallel pin	· The tooth surface of the cluster gear(6) is nonuniformly worn out and damaged. · The cluster gear(6) does not move smoothly.	-	-
4	Ring gear A	· The tooth surface is nonuniformly worn out and damaged.	-	-
5	Ring gear B	· The tooth surface is nonuniformly worn out and damaged.	-	-
7	Sun gear	· The tooth surface is nonuniformly worn out and damaged. · The spline section is worn.	-	-
8	Coupling gear	· Excessive wear or pitching is observed on the tooth surface.	-	-
19	Coupling	· The spline section is worn.	-	-
20	Thrust bearing R	· Worn out.	Axial clearance between coupling gear(8) and cover(13) : 0.3 to 0.6mm	Clearance : 0.8mm

Item No.	Part name	Situation	Standard dimension	Maximum allowable value(Criteria)
22	Distance piece	<ul style="list-style-type: none"> · The sliding surface is damaged. · The sliding surface is excessively worn out. 	-	-
24	Ball bearing	<ul style="list-style-type: none"> · Dents are present. · Flaking develops. · Nonuniform wear is present. 	-	-
201	Rear flange kit Rear flange	<ul style="list-style-type: none"> · The movable section contacting the spool(123) is damaged. · The clearance against the spool (123) is too large. 	Linear clearance : 10 to 20 μ	Linear clearance : 20 μ
223	Spool	<ul style="list-style-type: none"> · The outer surface is damaged. · The outer surface is nonuniformly worn out. 		
102	Shaft	<ul style="list-style-type: none"> · The surface contacting the oil seal(132) is worn out. · The spline section is worn out. 	-	-
103	Swash plate	<ul style="list-style-type: none"> · Seizure is observed. 	-	-
104	Cylinder block	<ul style="list-style-type: none"> · The spline section is worn out. · The bore inner surface is worn out too much. · The sliding surface that contacts the timing plate(109) is damaged or nonuniformly worn out. 	-	-
105 106	Piston assembly Piston Shoe	<ul style="list-style-type: none"> · An axial clearance is present between the piston(105) and the shoe(106). · The shoe is excessively worn out. · The shoe is nonuniformly worn out. 	Clearance : 0.05mm	Clearance : 0.15mm
107	Retainer plate	<ul style="list-style-type: none"> · The peripheral edge is nonuniformly worn out. 	-	-
108	Thrust ball	<ul style="list-style-type: none"> · The spherical sliding section that contacts the retainer plate(107) is nonuniformly worn out. 	-	-
109	Timing plate	<ul style="list-style-type: none"> · The sliding surface has the traces of seizure or nonuniformly wear. 	-	-

Item No.	Part name	Situation	Standard dimension	Maximum allowable value(Criteria)
115	Friction plate	<ul style="list-style-type: none"> · Both edges are nonuniformly worn out. 	Braking torque 49.3kgf · m or more	Braking torque 49.3kgf · m or less
116	Mating plate	<ul style="list-style-type: none"> · The required torque cannot be achieved. · The traces of seizure are present. 		
149	Ball bearing	<ul style="list-style-type: none"> · Dents are present. 		
150	Ball bearing	<ul style="list-style-type: none"> · Flaking develops. · Nonuniform wear is observed. 	-	-

6. RCV LEVER

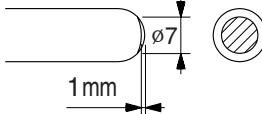
Maintenance check item	Criteria	Remark
Leakage	The valve is to be replaced when the leakage becomes more than 1000cc/m at neutral handle position, or more than 2000cc/m during operation.	Conditions : Primary pressure : 30kgf/cm ² Oil viscosity : 23cSt
Spool	This is to be replaced when the sliding surface has worn more than 10 μm, compared with the non-sliding surface.	The leakage at the left condition is estimated to be nearly equal to the above leakage.
Push rod	 <p>This is to be replaced when the top end has worn more than 1mm.</p>	
Play at operating section	The pin, shaft, and joint of the operating section are to be replaced when their plays become more than 2mm due to wears or so on.	When a play is due to looseness of a tightened section, adjust it.
Operation stability	When abnormal noises, hunting, primary pressure drop, etc. are generated during operation, and these cannot be remedied, referring to section 6. Troubleshooting, replace the related parts.	

- Notes
1. It is desirable to replace seal materials, such as O-rings, every disassembling. However, they may be reused, after being confirmed to be free of damage.
 2. When loosening the hexagon socket head cap screw(125), replace the seal washers(121) without fail.

7. RCV PEDAL

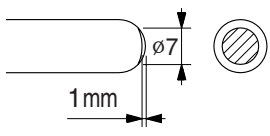
Maintenance check item	Criteria	Remark
Leakage	The valve is to be replaced when the leakage effect to the system. For example, the primary pressure drop.	Conditions : Primary pressure : 30kgf/cm ² Oil viscosity : 23cSt
Spool	This is to be replaced when the sliding surface has worn more than 10 μm, compared with the non-sliding surface.	The leakage at the left condition is estimated to be nearly equal to the above leakage.
Push rod	 <p>This is to be replaced when the top end has worn more than 1mm.</p>	
Play at operating section	The pin, shaft, and joint of the operating section are to be replaced when their plays become more than 2mm due to wears or so on.	When a play is due to looseness of a tightened section, adjust it.
Operation stability	When abnormal noises, hunting, primary pressure drop, etc. are generated during operation, and these cannot be remedied, referring to section 6. Troubleshooting, replace the related parts.	

Notes 1. It is desirable to replace seal materials, such as O-rings, every disassembling. However, they may be reused, after being confirmed to be free of damage.

8. TURNING JOINT

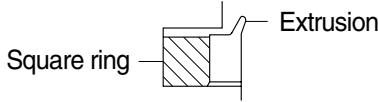
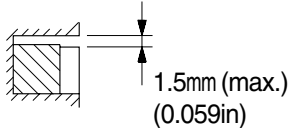
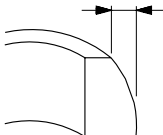
Part name		Maintenance standards	Remedy
Body, Stem	Sliding surface with sealing sections.	Plating worn or peeled due to seizure or contamination.	Replace
	Sliding surface between body and stem other than sealing section.	• Worn abnormality or damaged more than 0.1mm (0.0039in) in depth due to seizure contamination.	Replace
		• Damaged more than 0.1mm(0.0039in) in depth.	Smooth with oilstone.
	Sliding surface with thrust plate.	• Worn more than 0.5mm(0.02in) or abnormality.	Replace
• Worn less than 0.5mm(0.02in).		Smooth	
• Damage due to seizure or contamination remediable within wear limit (0.5mm)(0.02in).		Smooth	
Cover	Sliding surface with thrust plate.	• Worn more than 0.5mm(0.02in) or abnormality.	Replace
		• Worn less than 0.5mm(0.02in).	Smooth
		• Damage due to seizure or contamination remediable within wear limit (0.5mm)(0.02in).	Replace
Seal set	-	<ul style="list-style-type: none"> • Extruded excessively from seal groove square ring. 	Replace
	-	<ul style="list-style-type: none"> • Slipper ring 1.5mm(0.059in) narrower than seal groove, or narrower than back ring. 	Replace
	-	<ul style="list-style-type: none"> • Worn more than 0.5mm(0.02in) ~ 1.5mm(MAX.) (0.059in) 	Replace

9. CYLINDER

Part name	Inspecting section	Inspection item	Remedy
Piston rod	· Neck of rod pin	· Presence of crack	· Replace
	· Weld on rod hub	· Presence of crack	· Replace
	· Stepped part to which piston is attached.	· Presence of crack	· Replace
	· Threads	· Presence of crack	· Recondition or replace
	· Plated surface	· Plating is not worn off to base metal.	· Replace or replate
		· Rust is not present on plating. · Scratches are not present.	· Replace or replate · Recondition, replate or replace
	· Rod	· Wear of O.D.	· Recondition, replate or replace
· Bushing at mounting part	· Wear of I.D.	· Replace	
Cylinder tube	· Weld on bottom	· Presence of crack	· Replace
	· Weld on head	· Presence of crack	· Replace
	· Weld on hub	· Presence of crack	· Replace
	· Tube interior	· Presence of faults	· Replace if oil leak is seen
	· Bushing at mounting part	· Wear on inner surface	· Replace
Gland	· Bushing	· Flaw on inner surface	· Replace if flaw is deeper than coating