

GROUP 10 ENGINE CONTROL SYSTEM

1. CPU CONTROLLER AND ECM

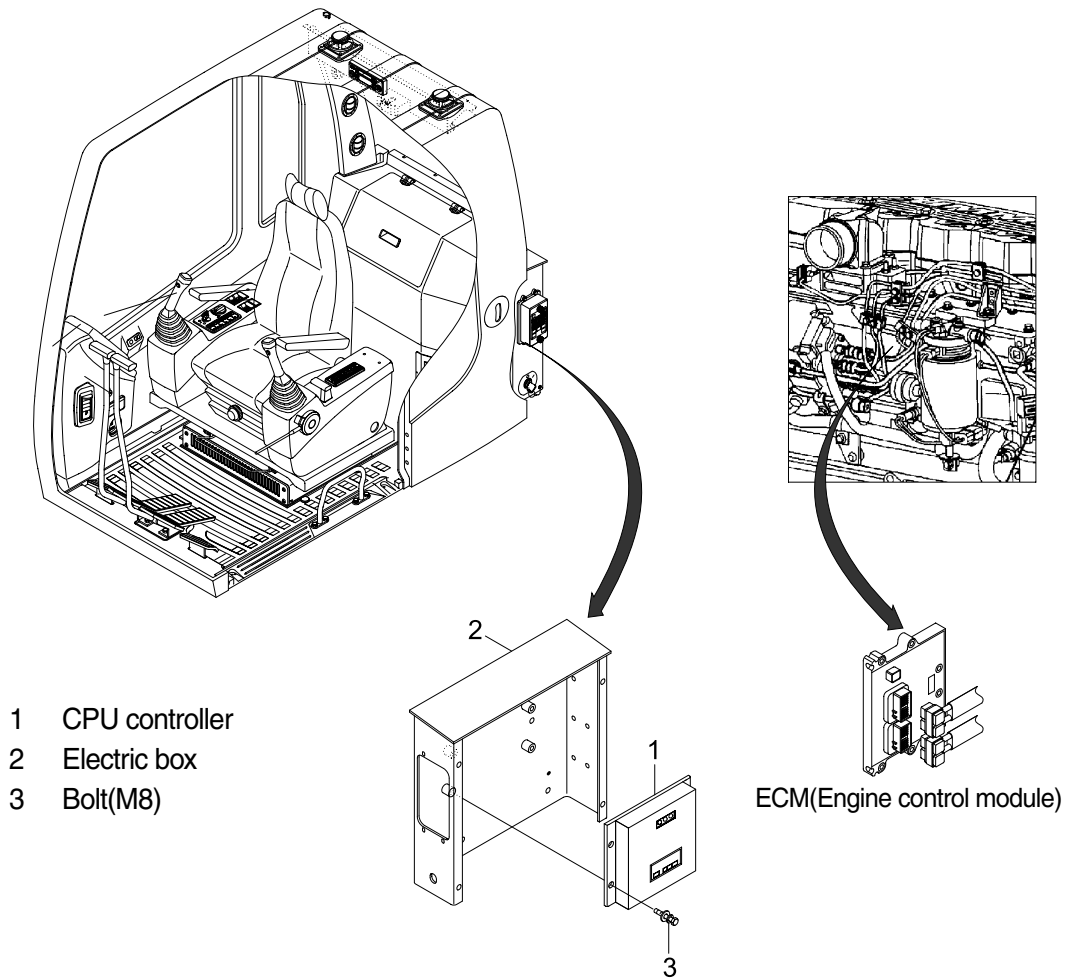

2507A5MS17

2. CPU CONTROLLER ASSEMBLY

- 1) Remove four pieces of bolt(3) of electric box(2).
- 2) Disconnect 2 connectors from CPU controller.
- 3) Remove 6 pieces of screw and open the cover of CPU controller.
- 4) Inspection : Check PCB(Printed Circuit Board)
 - (1) If any damage is found, replace CPU controller assembly.
 - (2) If not, but CAPO system does not work please report it to HHI dealer or A/S department.

3. EXCHANGE METHOD OF THE ROM IN THE CLUSTER

- 1) Disassemble the ash tray(2).
- 2) Disassemble the wiper motor cover(3).
- 3) Disassemble the cluster(1).

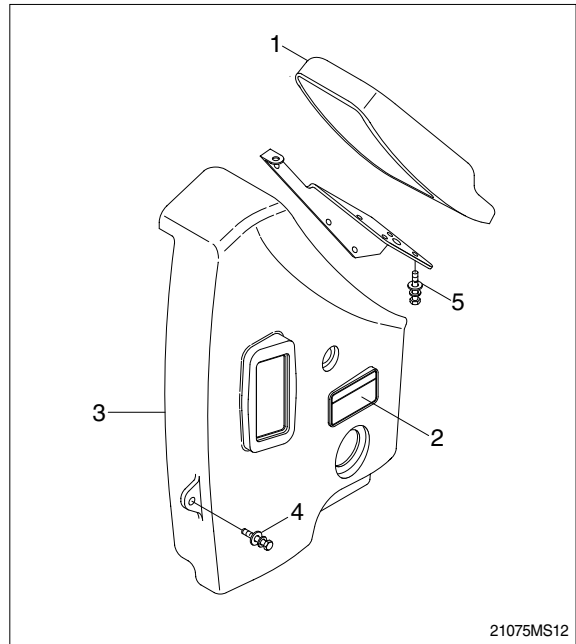

- 4) Loosen the screws(6EA) located back of the cluster.
- 5) Then you can open the upper case of the cluster easily.

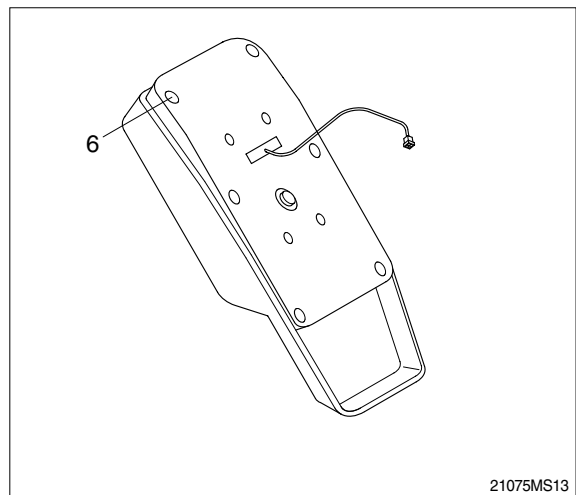

- 6) Install the new ROM.(Be careful of direction and assemble the cluster in the reverse order to removal).

