

GROUP 7 RCV LEVER

1. REMOVAL AND INSTALL

1) REMOVAL

- (1) Lower the work equipment to the ground and stop the engine.
- (2) Operate the control levers and pedals several times to release the remaining pressure in the hydraulic piping.
- (3) Loosen the breather slowly to release the pressure inside the hydraulic tank.
- ▲ Escaping fluid under pressure can penetrate the skin causing serious injury.
- (4) Loosen the socket bolt(1).
- (5) Remove the cover of the console box.
- (6) Disconnect pilot line hoses(3).
- (7) Remove the pilot valve assembly(2).
When removing the pilot valve assembly, check that all the hoses have been disconnected.

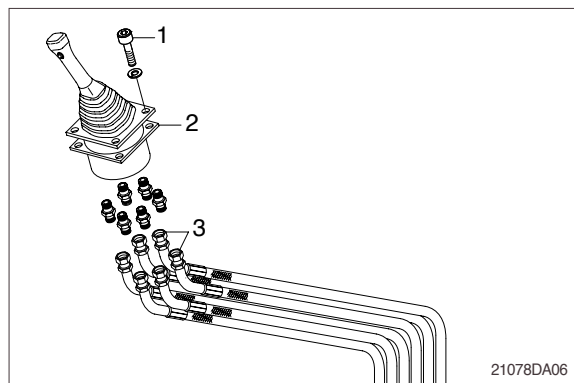

2) INSTALL

- (1) Carry out installation in the reverse order to removal.
- (2) Confirm the hydraulic oil level and check the hydraulic oil leak or not.

2. DISASSEMBLY AND ASSEMBLY

1) STRUCTURE

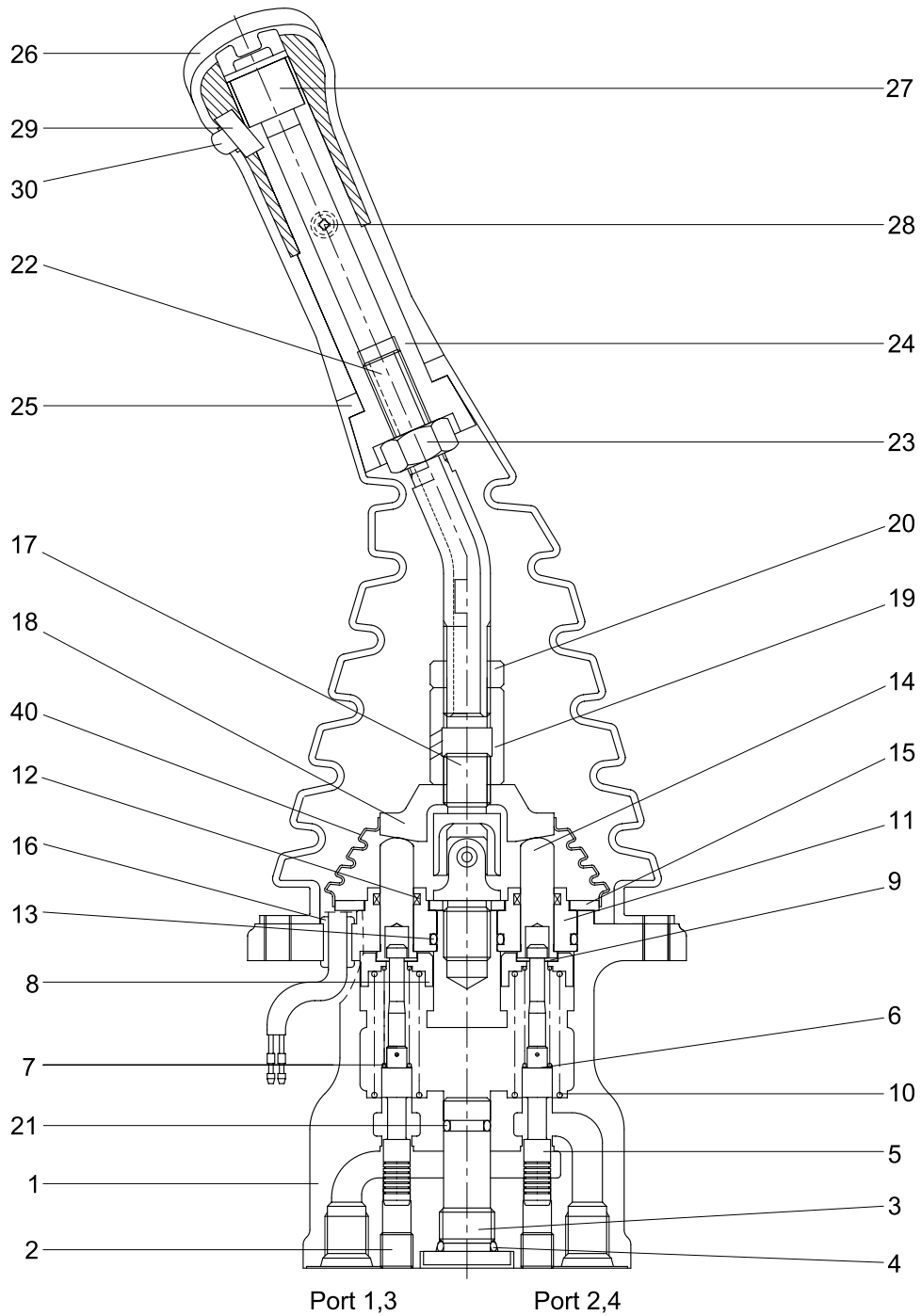

14072SF80

1	Case	11	Plug	21	O-ring
2	Plug	12	Rod seal	22	Handle connector
3	Plug	13	O-ring	23	Nut
4	O-ring	14	Push rod	24	Insert
5	Spool	15	Plate	25	Boot
6	Shim	16	Bushing	26	Handle
7	Spring	17	Joint assembly	27	Switch assembly
8	Spring seat	18	Swash plate	28	Screw
9	Stopper	19	Adjusting nut	29	Switch assembly
10	Spring	20	Lock nut	30	Switch cover
				40	Boot

2) TOOLS AND TIGHTENING TORQUE

(1) Tools

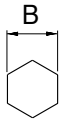
Tool name	Remark	
Allen wrench	6	
Spanner	22	
	27	
(+) Driver	Length 150	
(-) Driver	Width 4~5	
Torque wrench	Capable of tightening with the specified torques	

(2) Tightening torque

Part name	Item	Size	Torque	
			kgf · m	lbf · ft
Plug	2	PT 1/8	3.0	21.7
Joint	17	M14	3.5	25.3
Swash plate	18	M14	5.0 ± 0.35	36.2 ± 2.5
Adjusting nut	19	M14	5.0 ± 0.35	36.2 ± 2.5
Lock nut	20	M14	5.0 ± 0.35	36.2 ± 2.5
Screw	28	M 3	0.05	0.36

3) DISASSEMBLY

- (1) Clean pilot valve with kerosene.
Put blind plugs into all ports
- (2) Fix pilot valve in a vise with copper(or lead) sheets.
- (3) Remove end of boot(25) from case(1) and take it out upwards.

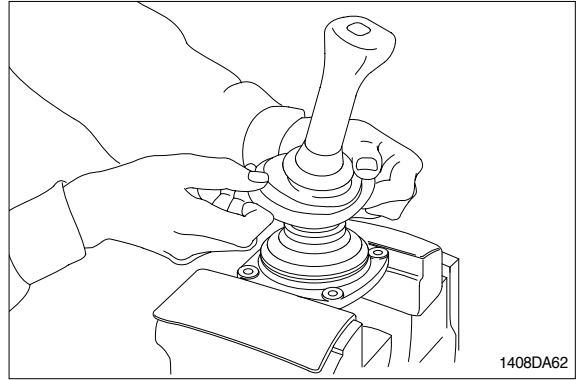

For valve with switch, remove cord also through hole of casing.

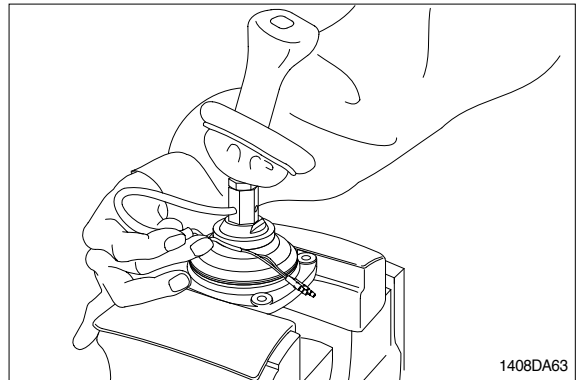

- (4) Loosen lock nut(20) and adjusting nut(19) with spanners on them respectively, and take out handle section as one body.

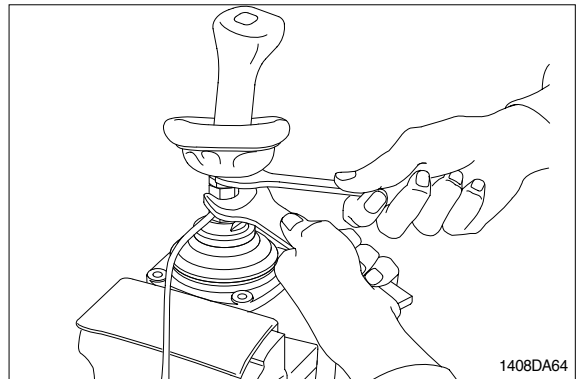

- (5) Remove the boot(40)

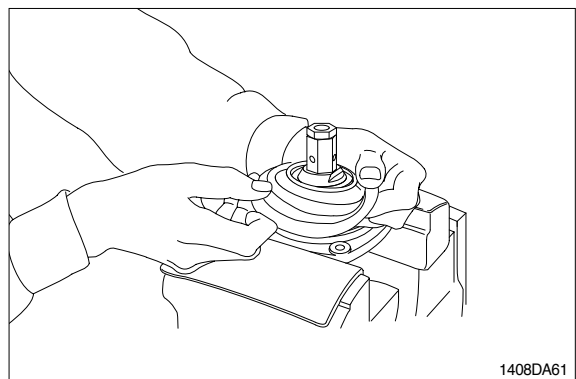

- (6) Loosen adjusting nut(19) and plate(18) with spanners on them respectively, and remove them.

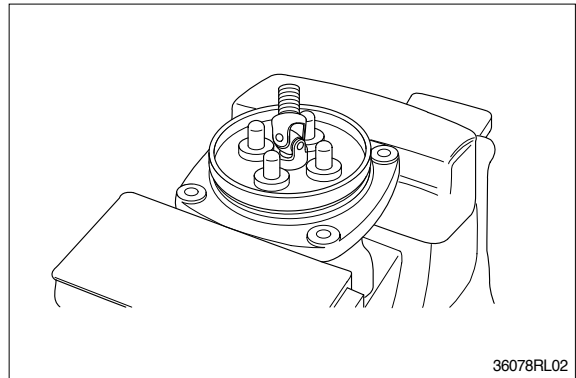
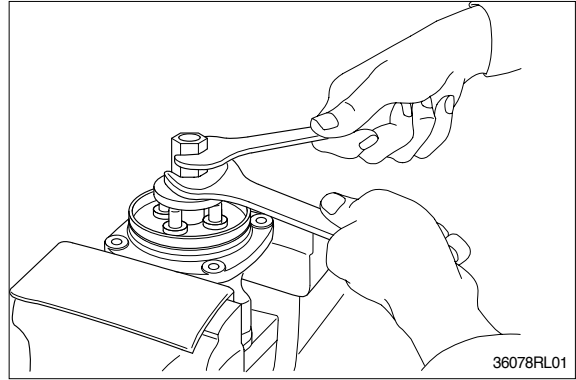

- (7) Turn joint anticlockwise to loosen it, utilizing jig(Special tool).
When return spring(10) is strong in force, plate(15), plug(11) and push rod(14) will come up on loosening joint.
Pay attention to this.

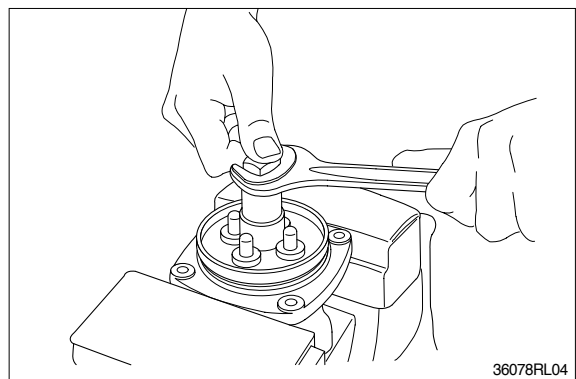
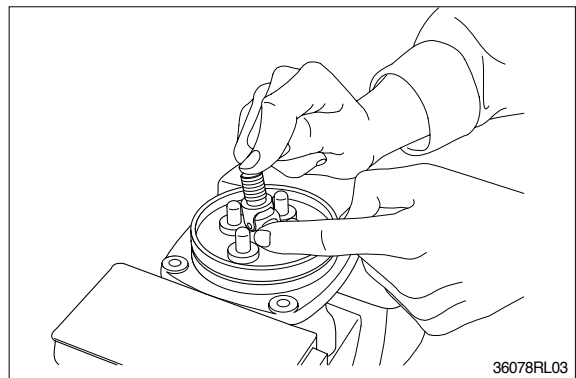

(8) Remove plate(15).

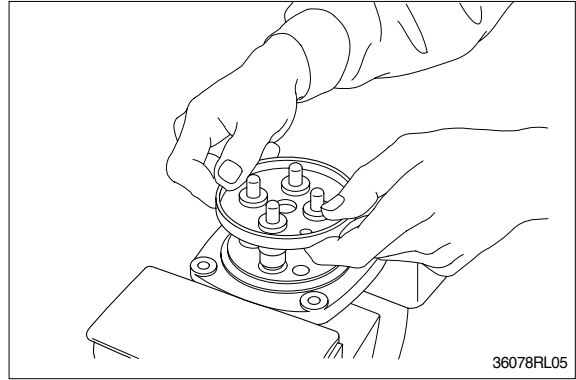

(9) When return spring(10) is weak in force, plug(11) stays in casing because of sliding resistance of O-ring.
Take it out with minus screwdriver.
Take it out, utilizing external periphery groove of plug and paying attention not to damage it by partial loading.
During taking out, plug may jump up due to return spring(10) force.
Pay attention to this.

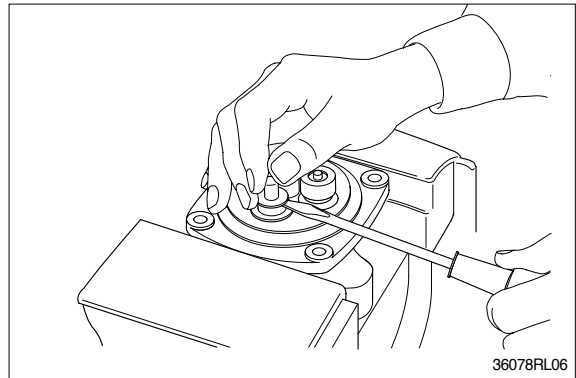

(10) Remove reducing valve subassembly and return spring(10) out of casing.
Record relative position of reducing valve subassembly and return springs.

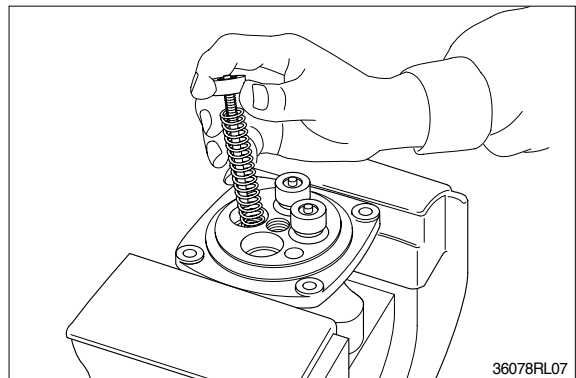

(11) Loosen hexagon socket head plug(2) with hexagon socket screw key.

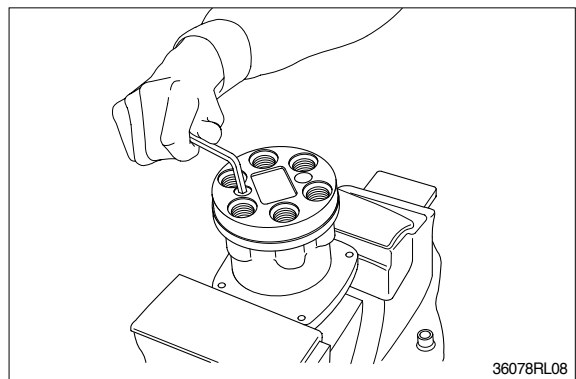

(12) For disassembling reducing valve section, stand it vertically with spool(5) bottom placed on flat workbench. Push down spring seat(8) and remove two pieces of semicircular stopper(9) with tip of small minus screwdriver.

Pay attention not to damage spool surface.

Record original position of spring seat(8, 31).

Do not push down spring seat more than 6mm.

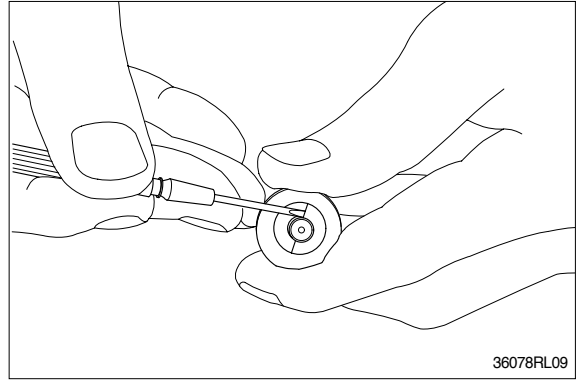

(13) Separate spool(5), spring seat(8), spring(7) and shim(6) individually.

Until being assembled, they should be handled as one subassembly group.

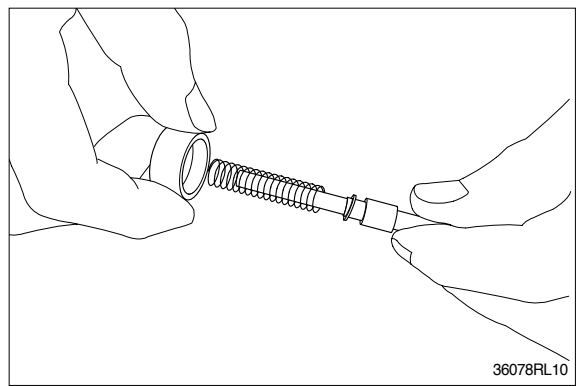

(14) Take push rod(14) out of plug(11).

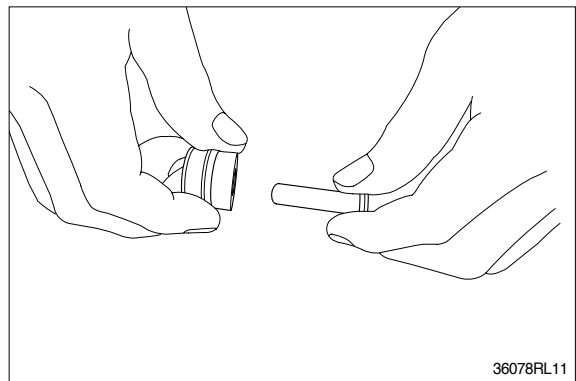

(15) Remove O-ring(13) and seal(12) from plug(11).

Use small minus screwdriver or so on to remove this seal.

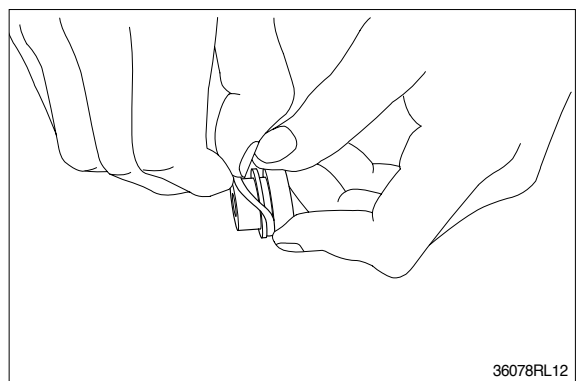

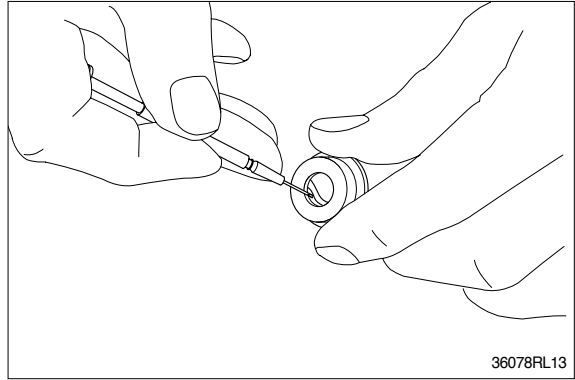

(16) Remove lock nut(20) and then boot(25).

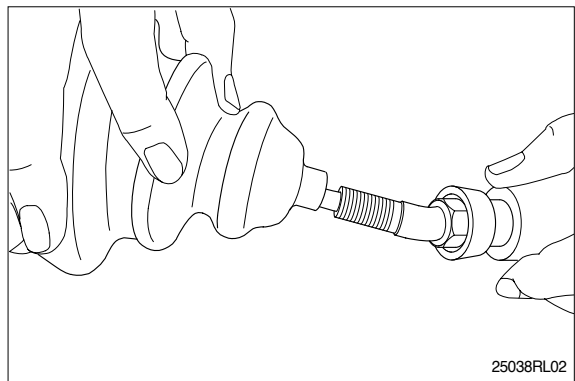
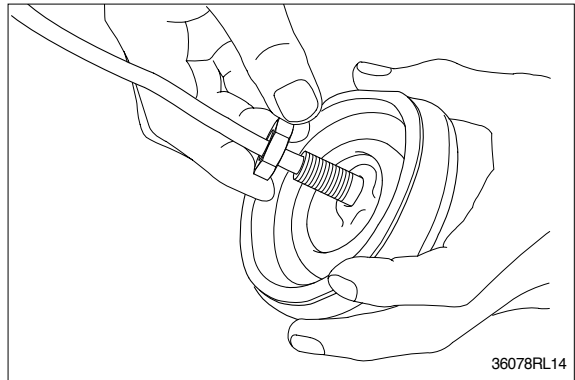

(16) Cleaning of parts

Put all parts in rough cleaning vessel filled with kerosene and clean them (Rough cleaning).

If dirty part is cleaned with kerosene just after putting it in vessel, it may be damaged. Leave it in kerosene for a while to loosen dust and dirty oil.

If this kerosene is polluted, parts will be damaged and functions of reassembled valve will be degraded.

Therefore, control cleanliness of kerosene fully.

Put parts in final cleaning vessel filled with kerosene, turning it slowly to clean them even to their insides (Finish cleaning).

Do not dry parts with compressed air, since they will be damaged and/or rusted by dust and moisture in air.

(17) Rust prevention of parts.

Apply rust-preventives to all parts.

If left as they are after being cleaned, they will be rusted and will not display their functions fully after being reassembled.

4) ASSEMBLY

- (1) Tighten hexagon socket head plug(2) to the specified torque.

Tighten two bolts alternately and slowly.

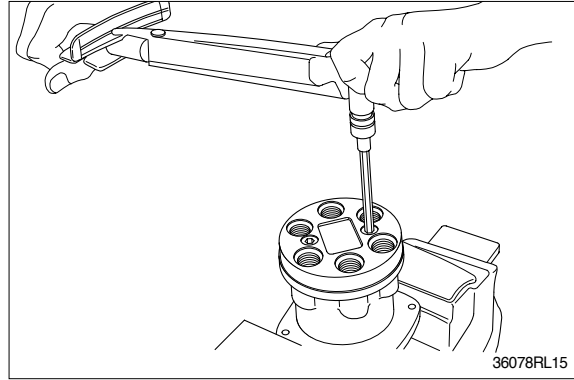

- (2) Put shim(6), springs(7) and spring seat(8) onto spool(5) in this order.

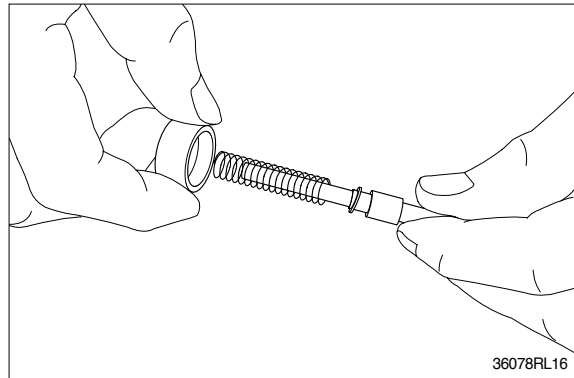

- (3) Stand spool vertically with its bottom placed on flat workbench, and with spring seat pushed down, put two pieces of semicircular stopper(9) on spring seat without piling them on.

Assemble stopper(9) so that its sharp edge side will be caught by head of spool. Do not push down spring seat more than 6mm.

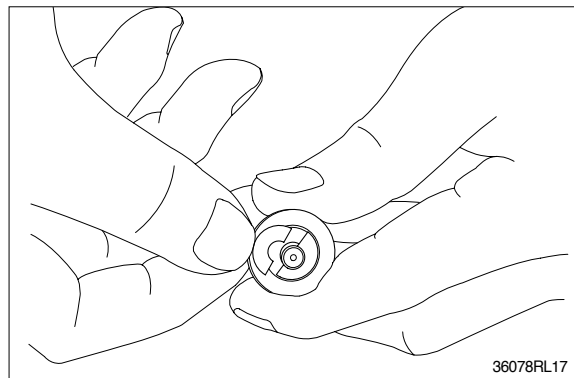

- (4) Assemble spring(10) into casing(1).
Assemble reducing valve subassembly into casing.
Assemble them to their original positions.

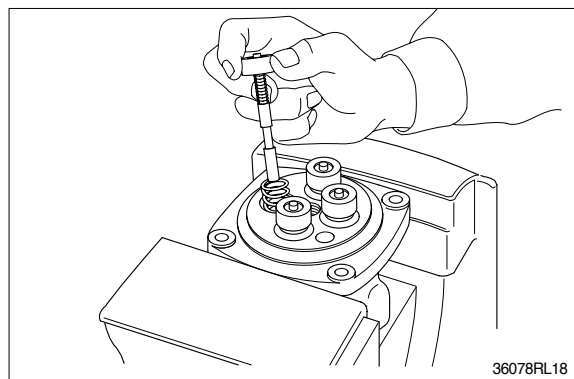

(5) Assemble O-ring(13) onto plug(11).

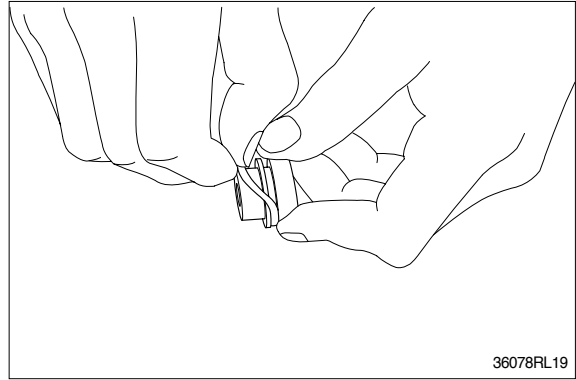

(6) Assemble seal(12) to plug(11).
Assemble seal in such lip direction as shown below.

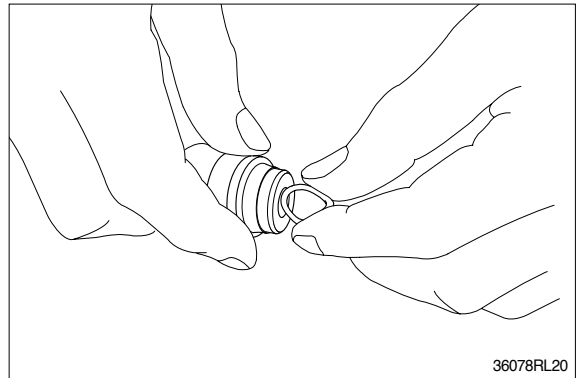

(7) Assemble push rod(14) to plug(11).
Apply working oil on push-rod surface.

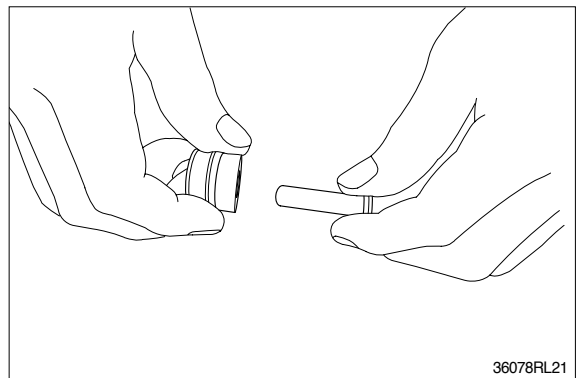

(8) Assemble plug subassembly to casing.
When return spring is weak in force,
subassembly stops due to resistance of
O-ring.

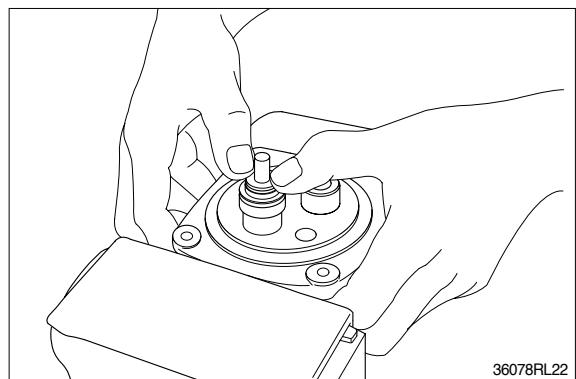

- (9) When return spring is strong in force, assemble 4 sets at the same time, utilizing plate(15), and tighten joint(17) temporarily.

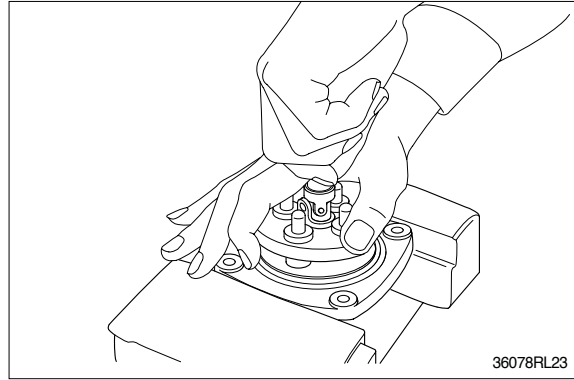

- (10) Fit plate(15).

- (11) Tighten joint(17) with the specified torque to casing, utilizing jig.

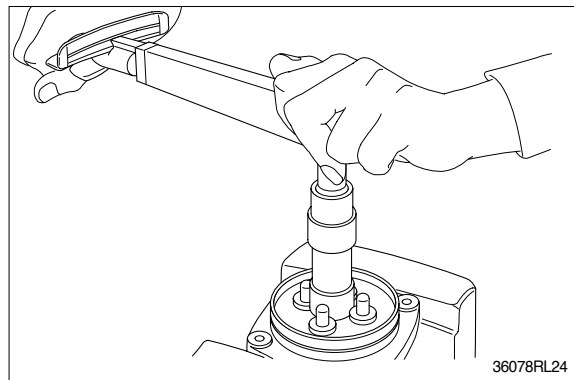

- (12) Assemble swash plate(18) to joint(17).
Screw it to position that it contacts with 4 push rods evenly.
Do not screw it over.

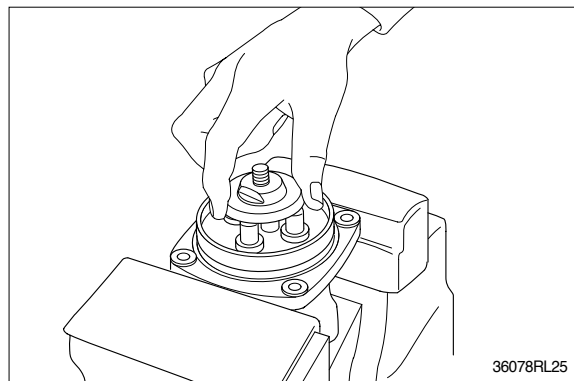

- (13) Assemble adjusting nut(19), apply spanner to width across flat of plate(18) to fix it, and tighten adjusting nut to the specified torque.
During tightening, do not change position of disk.

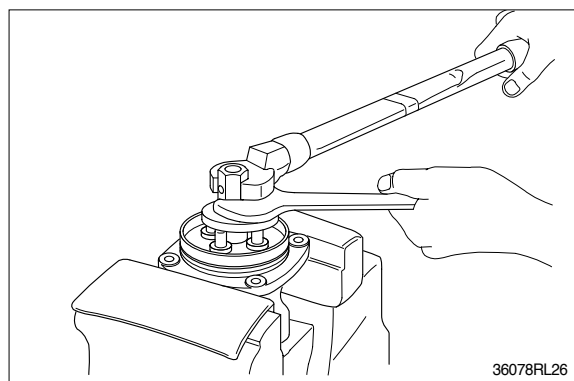

(14) Fit boot(40) to plate.

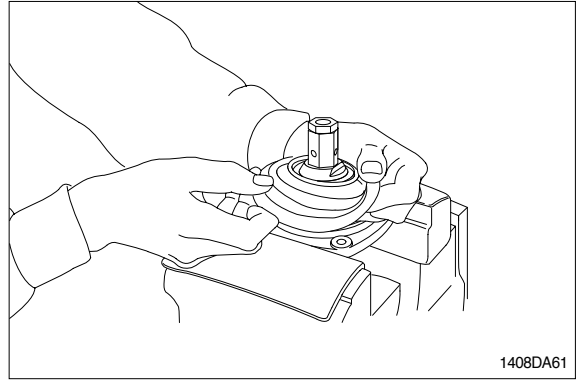

(15) Fit boot(25) and lock nut(20), and handle subassembly is assembled completely.

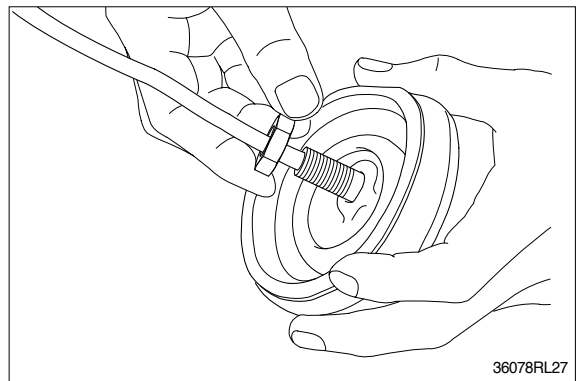
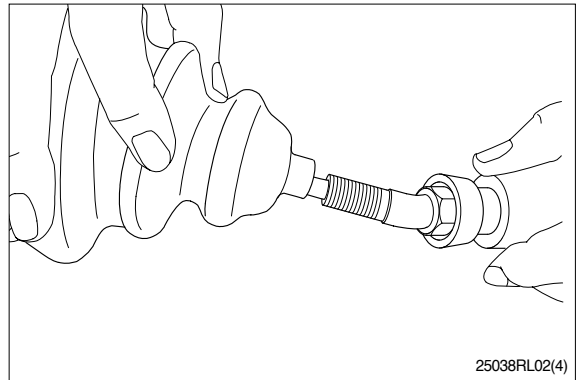

(16) Pull out cord and tube through adjusting nut hole provided in direction 60. to 120. from casing hole.

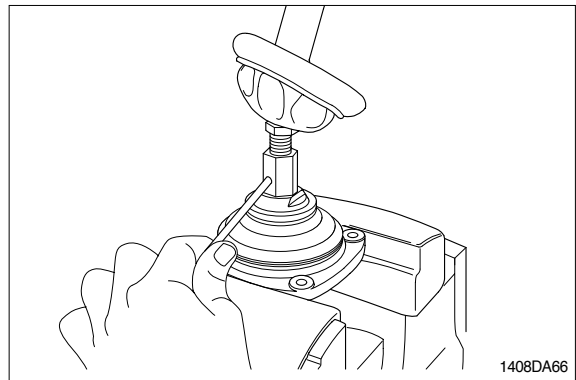

- (17) Assemble bushing(16) to plate and pass cord and tube through it.
Provide margin necessary to operation.

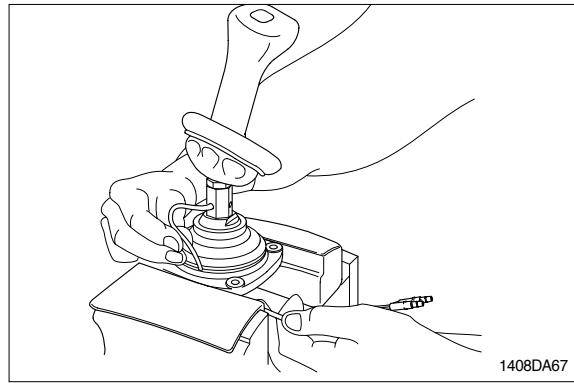

- (18) Determine handle direction, tighten lock nut(20) to specified torque to fix handle.

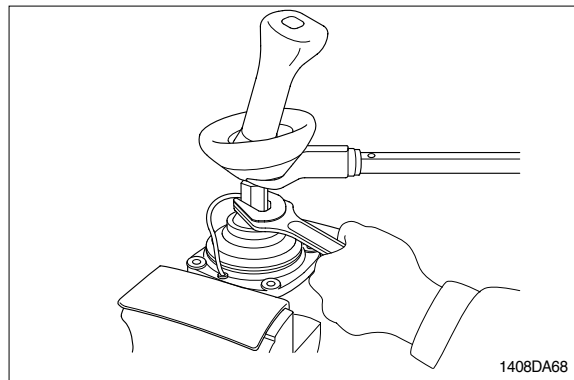

- (19) Apply grease to rotating section of joint and contacting faces of disk and push rod.

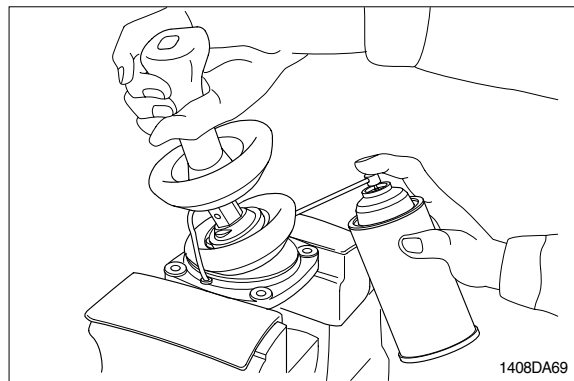

- (20) Assemble lower end of bellows to casing.
(21) Inject volatile rust-preventives through all ports and then put blind plugs in ports.

