

## GROUP 2 MODE SELECTION SYSTEM

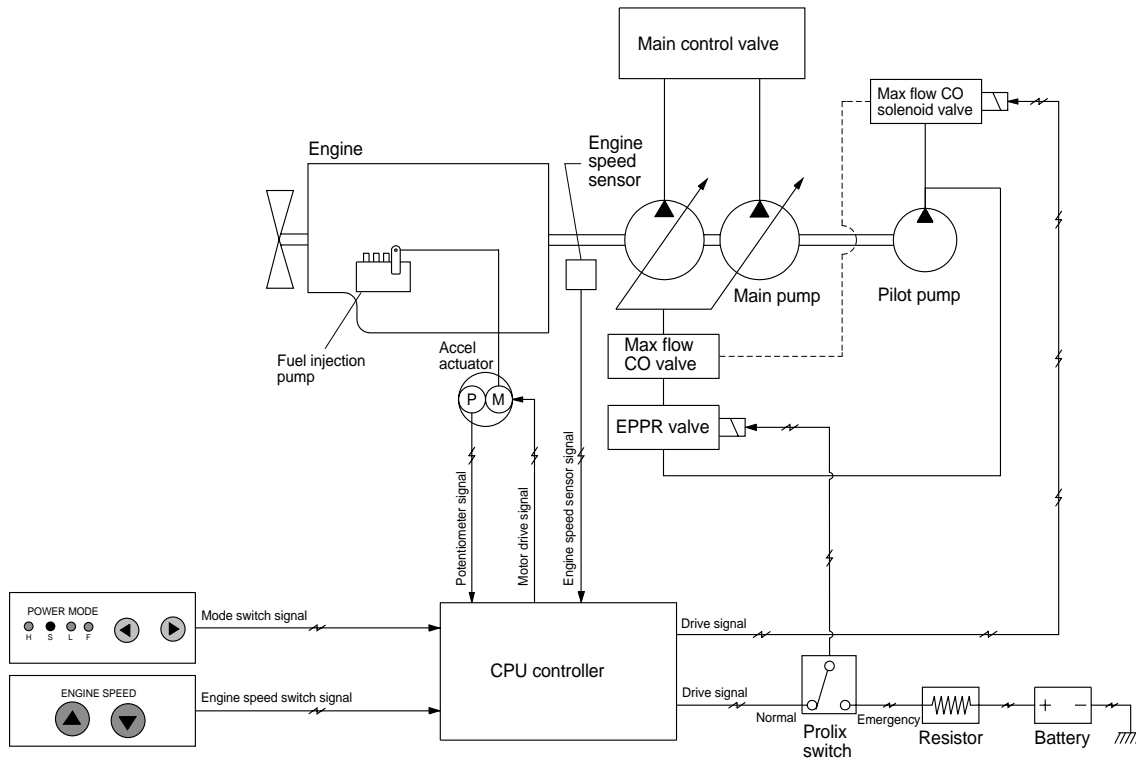

### 1. OUTLINE

Mode selection system(Micro computer based electro-hydraulic pump and engine mutual control system) optimizes the engine and pump performance.

The combination of 4 power modes(H, S, L, F) makes it possible to use the engine and pump power more effectively corresponding to the work conditions from a heavy and great power requesting work to a light and precise work.

Mode	Application	Power set (%)	Engine rpm		Power shift by EPPR valve		Max flow cut off
			Unload	Load	Current (mA)	Pressure (kg/cm <sup>2</sup> )	
H	Heavy duty operation	100	2450±50	2200	250±30	5	CANCEL
S	Standard operation	85	2250±50	2000	230±30	4	CANCEL
L	Light duty operation	70	2250±50	2000	370±30	14	ACTIVE
F	Finishing and precise operation	50	1750±50	1500	400±30	16	CANCEL
AUTO DECEL	Engine deceleration	-	1200±100	-	700±30	40	
KEY START	Key switch start position	-	950±100	-	700±30	40	

## 2. PUMP CONTROL BY ENGINE SPEED SENSING

If any engine speed drops under the reference rpm of each mode set caused by the pump load are detected by the engine speed sensor, CPU controller sends calculated current signal to EPPR(Electro Proportional Pressure Reducing) valve to match engine torque with pump torque optimally by controlling the pump discharge volume.

- **H** : Heavy duty operation mode
- **S** : General operation mode
- **L** : Lifting operation mode
- **F** : Finishing operation mode

### • Engine Torque

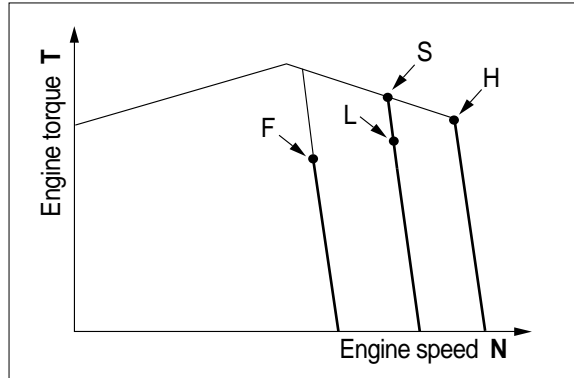

### • Engine horsepower

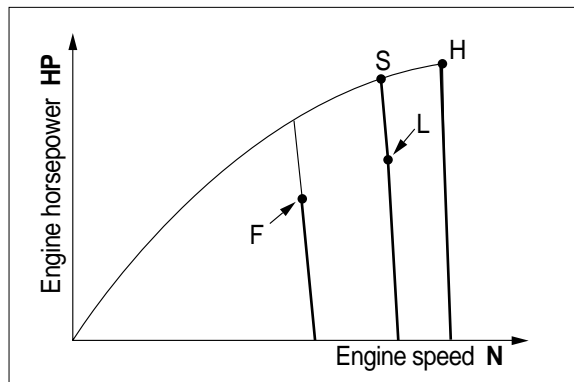

### • Main pump delivery

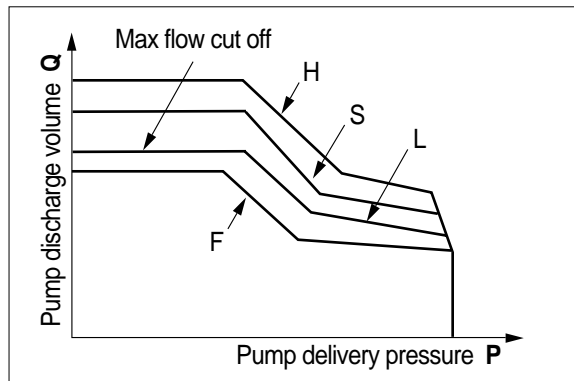

### 3. MAXIMUM POWER OF "H" MODE

- 1) When **H** mode is selected in the cluster, CPU controller moves the engine governor motor to set the throttle lever to the full position and sends initial current signal to the EPPR valve to set the pump absorption torque high. So, it is possible to maximize the work performance by using 100% of the engine power at this mode.
- 2) If the pump load becomes too high and the engine speed drops, the CPU controller reduces the pump discharge amount and momentarily resets the engine speed to the rated point through engine speed sensing.

#### • Engine Torque

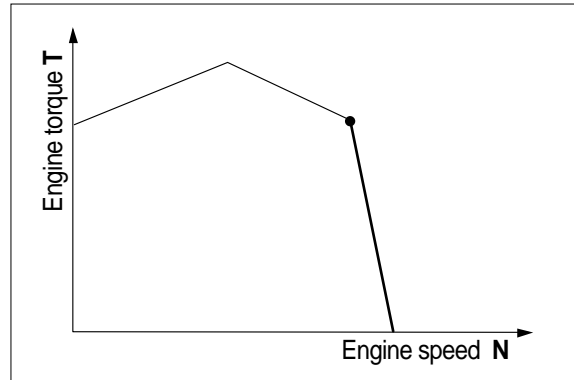

#### • Engine horsepower

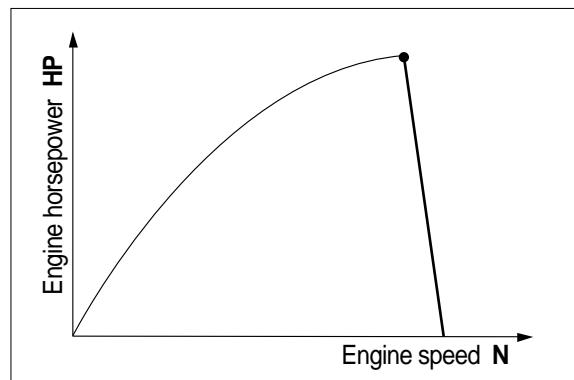

#### • Main pump delivery

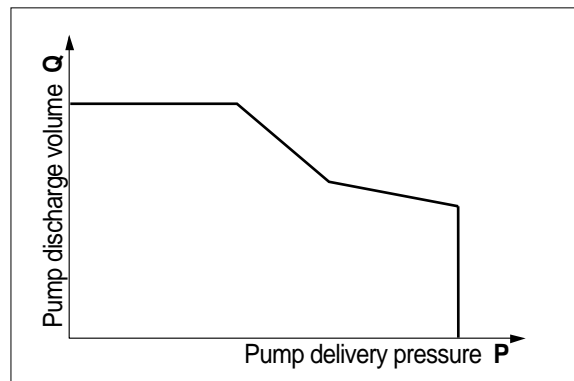

#### 4. GENERAL STANDARD POWER OF "S" MODE

- 1) When **S** mode is selected in the cluster, CPU controller moves the engine governor motor to set the throttle lever to the partial position and sends power shift current to EPPR valve which reduces the pump discharge. So the pump absorption horsepower is reduced by 15%.
- 2) At **S** mode operation energy saving is about 15% and engine speed sensing at the matching point is the same as for **H** mode.

##### • Engine Torque

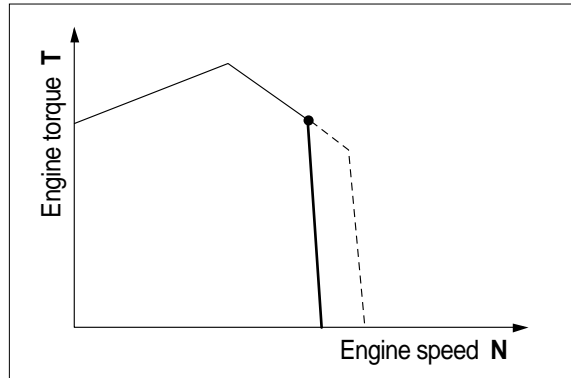

##### • Engine horsepower

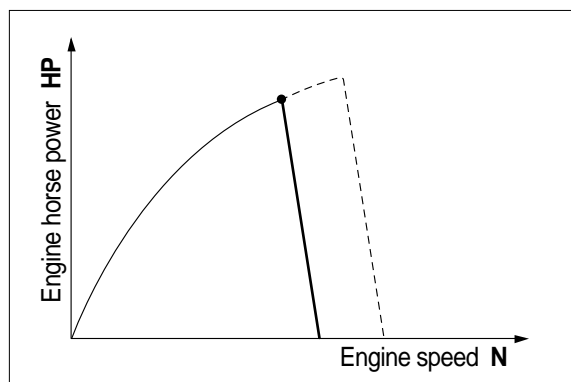

##### • Main pump delivery

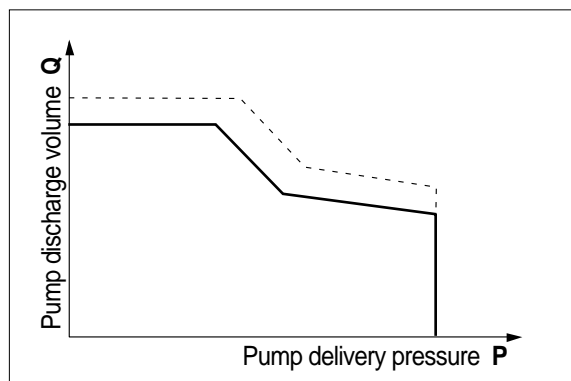

## 5. ENERGY SAVING AND LIGHT POWER OF "L" MODE

- 1) When L mode is selected in the cluster, CPU controller moves the engine governor motor to set the throttle lever to the partial position and it sends large amount of power shift current to EPPR valve, which reduces the pump absorption horsepower 30%. So, at this mode it is useful for light work and energy saving.
- 2) Engine speed and pump absorption torque are different, but the engine speed sensing at the matching point is the same as for H mode.
- 3) At this mode max flow cut off solenoid is activated to cut down the pump discharge at low pressure (Below 100kgf/cm<sup>2</sup>) operation. It makes the slow and precise operation of the machine is possible at low pressure requested work.

### • Engine Torque

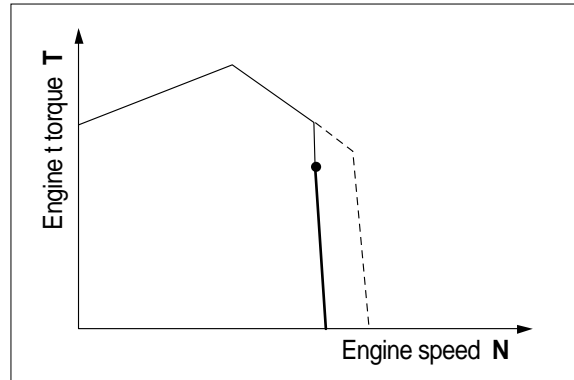

### • Engine horsepower

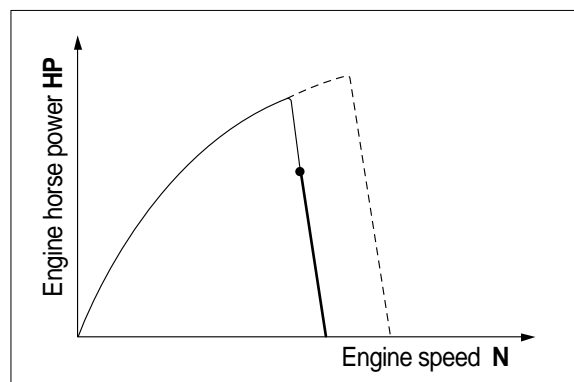

### • Main pump delivery

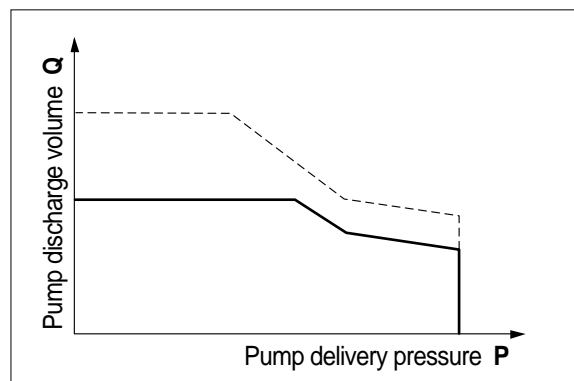

## 6. FINISHING WORK OF "F" MODE

- 1) When **F** mode is selected in the cluster, CPU controller moves the engine governor motor to set the throttle lever to the partial position and it sends large amount of power shift current to EPPR valve to reduce the pump absorption horsepower to 50% of full horsepower. So, at this mode it is useful for light and precise work, especially for finishing work.
- 2) Engine speed is set at highly efficient area for engine fuel consumption, so the fuel reduction effect is extremely high.

### • Engine Torque

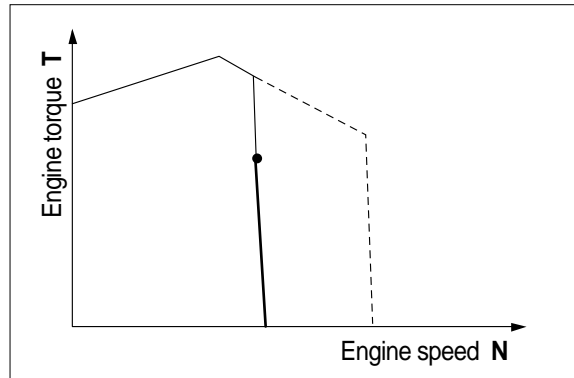



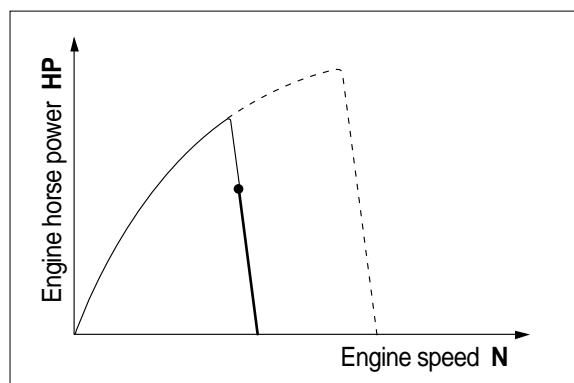

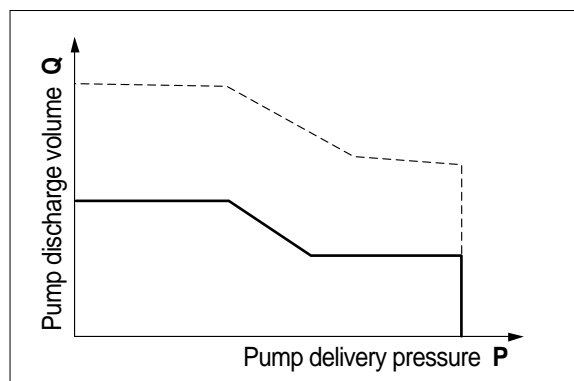

### • Engine horsepower

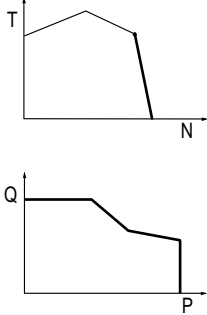
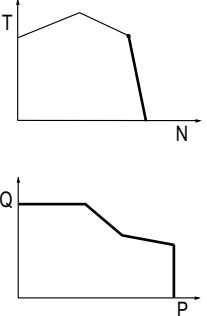
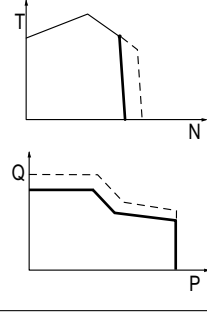

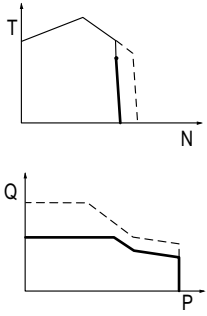
### • Main pump delivery

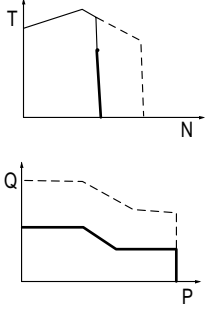

Mode	Power boost switch OFF		Power boost switch ON		Other functions		
	Power set	Level of achievement	Power set	Level of achievement	Max flow cut off	Auto decel	Overheat prevention
H	161HP/ 2200rpm	<ul style="list-style-type: none"> <li>Full power used by engine speed sensing.</li> </ul> 	161HP/ 2200rpm	<ul style="list-style-type: none"> <li>Full power used by engine speed sensing.</li> <li>Power increased by power boost solenoid valve.</li> </ul> 	CANCEL	ON / OFF	ON
S	137HP/ 2000rpm	<ul style="list-style-type: none"> <li>Fuel consumption improved by partial use of engine power.</li> </ul> 		161HP/ 2200rpm	<ul style="list-style-type: none"> <li>Fuel consumption improved by partial use of engine power.</li> </ul> 	CANCEL	ON / OFF
L	113HP/ 2000rpm	<ul style="list-style-type: none"> <li>Slow machine operation at low pressure.</li> </ul> 	161HP/ 2200rpm			ACTIVE	ON / OFF
F	81HP/ 1500rpm	<ul style="list-style-type: none"> <li>Increase of fine control range.</li> <li>High improvement in fuel consumption by lowering engine speed.</li> </ul> 		161HP/ 2200rpm		CANCEL	ON / OFF