

GROUP 2 MODE SELECTION SYSTEM

1. POWER MODE SELECTION SYSTEM

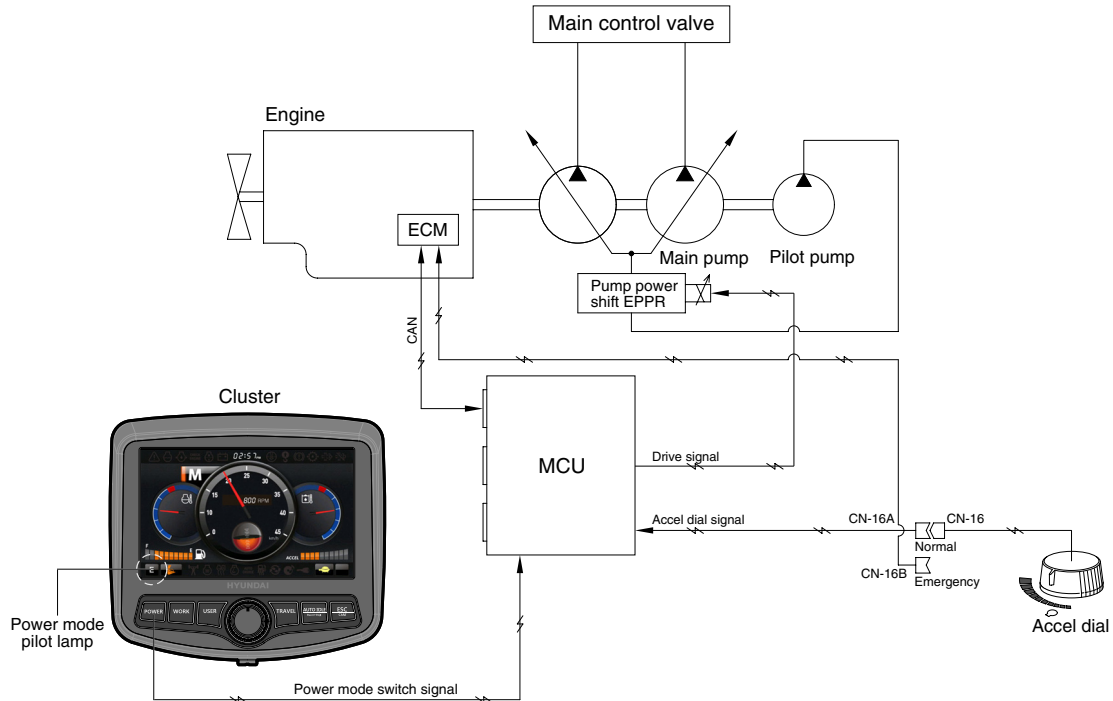

2609A5MS02

Mode selection system (micro computer based electro-hydraulic pump and engine mutual control system) optimizes the engine and pump performance.

The combination of 3 power modes (P, S, E) and accel dial position (10 set) makes it possible to use the engine and pump power more effectively corresponding to the work conditions from a heavy and great power requesting work to a light and precise work.

Power mode	Application	Engine rpm				Power shift by EPPR valve			
		Standard		Option		Standard		Option	
		Unload	Load	Unload	Load	Current (mA)	Pressure (kgf/cm ²)	Current (mA)	Pressure (kgf/cm ²)
P	Heavy duty power	1800±50	1950±50	2000±50	1950±50	290±30	8.0	160±30	0
S	Standard power	1700±50	1850±50	1900±50	1850±50	305±30	10±3	250±30	5±3
E	Economy operation	1600±50	1750±50	1700±50	1850±50	305±30	10±3	330±30	10±3
AUTO DECEL	Engine deceleration	1000±100	-	1000±100	-	700±30	38±3	700±30	38±3
One touch decel	Engine quick deceleration	850±100	-	850±100	-	700±30	38±3	700±30	38±3
KEY START	Key switch start position	850±100	-	850±100	-	700±30	38±3	700±30	38±3

※ Power shift (Standard/Option) can be changed by "Service menu" in "Management" on the cluster.

2. WORK MODE SELECTION SYSTEM

Work mode consists of the general operation (bucket) and the optional attachment (breaker, crusher).

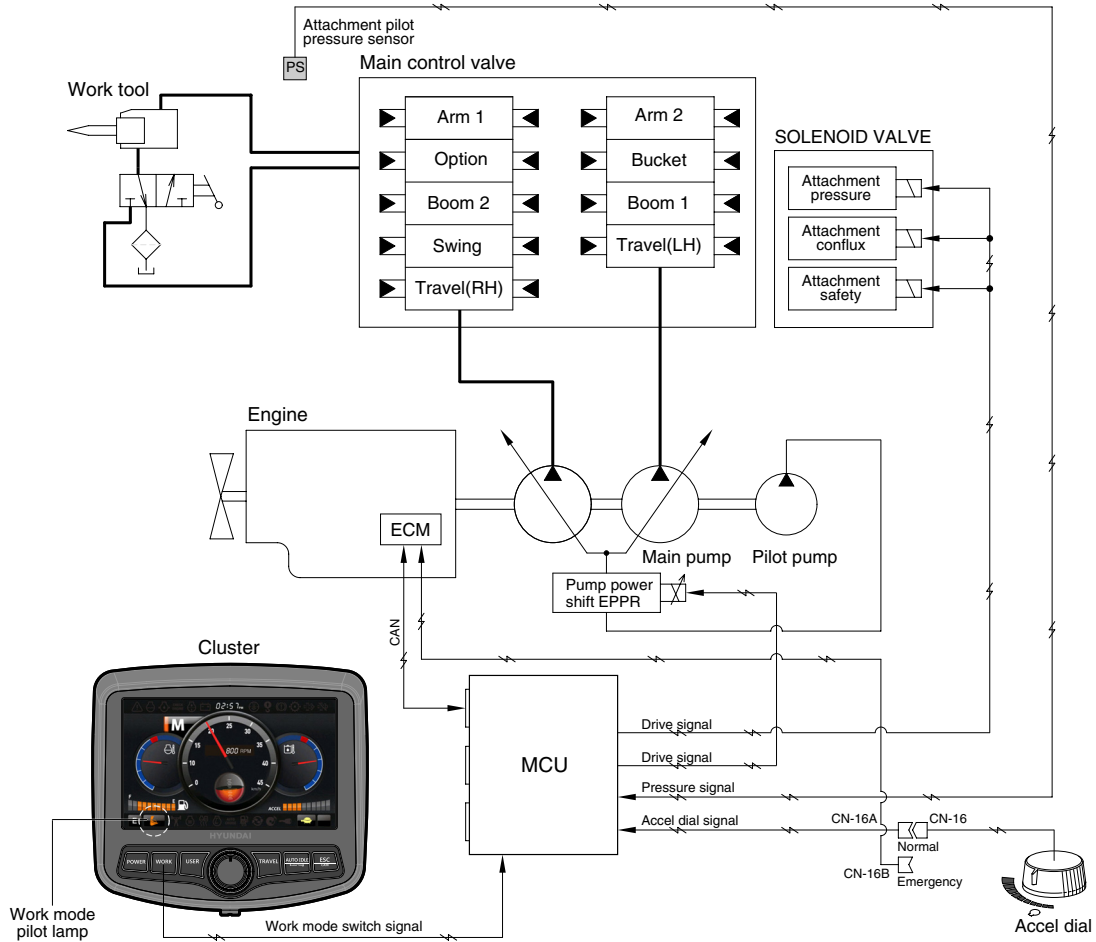

2609A5MS03

1) GENERAL WORK MODE (bucket)

This mode is used to general digging work.

2) ATT WORK MODE (breaker, crusher)

It controls the pump flow and system pressure according to the operation of breaker or crusher.

Description	General mode	Work tool	
	Bucket	Breaker	Crusher
Attachment safety solenoid	OFF	ON	ON
Attachment pressure solenoid	OFF	OFF	ON
Attachment conflux solenoid	OFF	OFF	ON/OFF
Attachment flow EPPR current	100 mA	100~700 mA	100~700 mA

3. USER MODE SELECTION SYSTEM

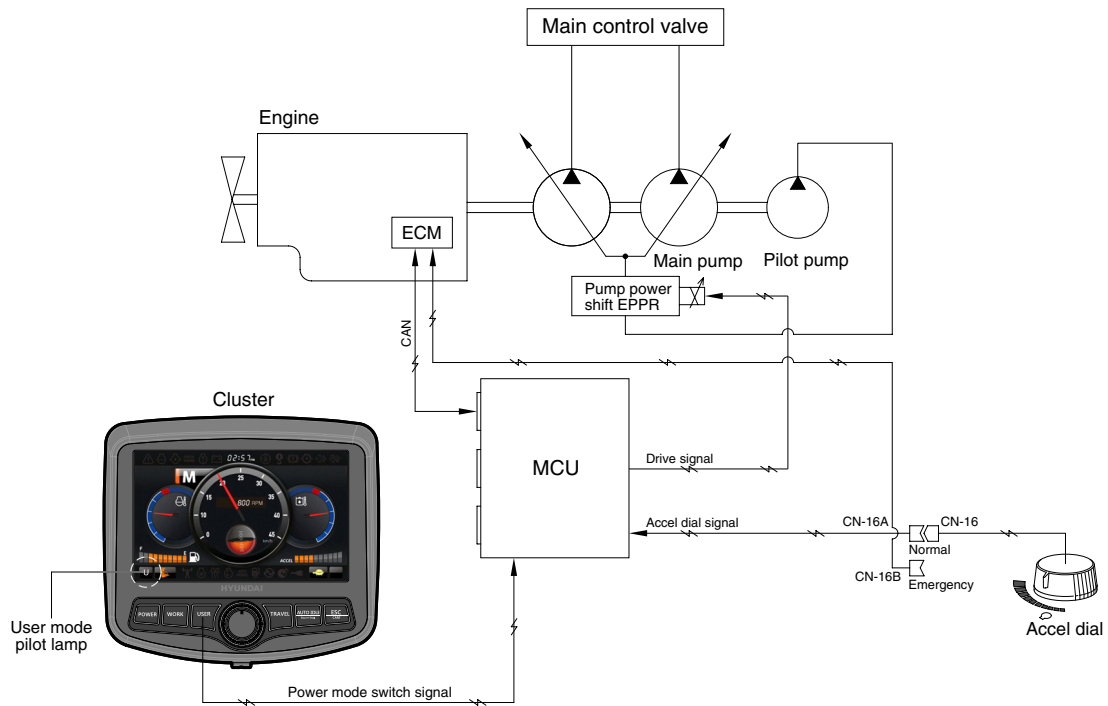

2609A5MS04

1) High idle rpm, auto idle rpm and EPPR pressure can be adjusted and memorized in the U-mode.

2) LCD segment vs parameter setting

Step ()	Engine speed (rpm)	Idle speed (rpm)	Power shift (bar)
1	1300	750	0
2	1400	800	3
3	1500	850	6
4	1600	900	9
5	1700	950	12
6	1800	1000 (auto decel)	16
7	1850	1050	20
8	1900	1100	26
9	1950	1150	32
10	2000	1200	38