

GROUP 2 SPECIFICATIONS

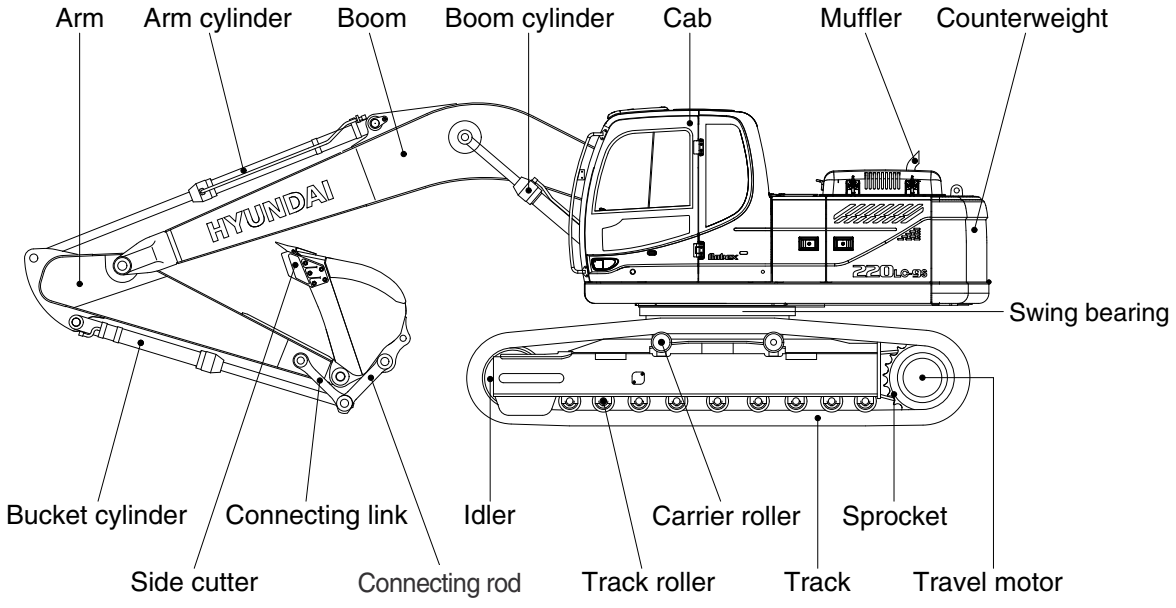
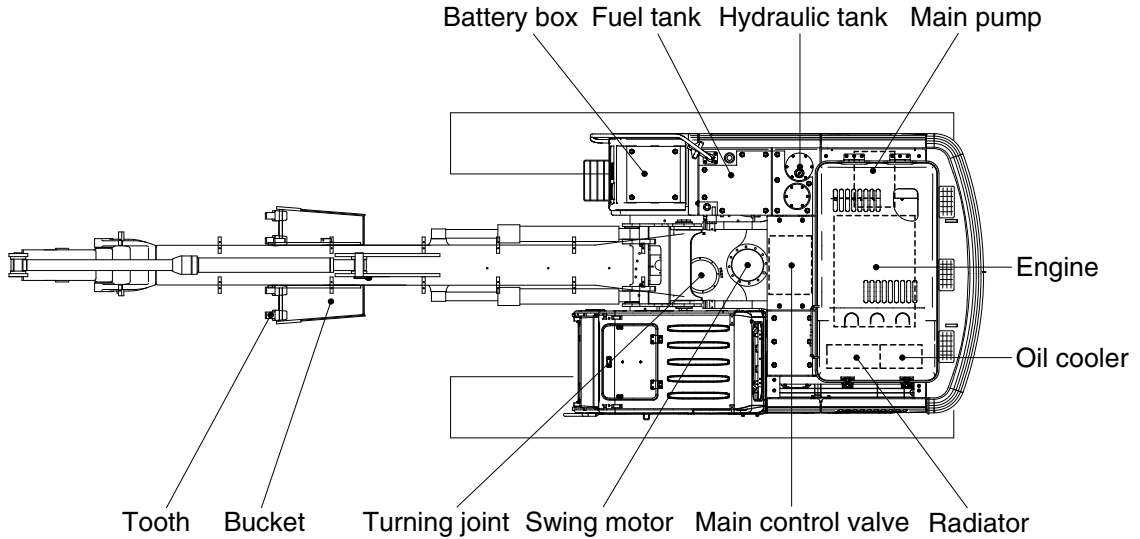

2209S2SP01

2. SPECIFICATIONS

1) R220LC-9S

- 5.68 m (18' 8") BOOM and 2.92 m (9' 7") ARM

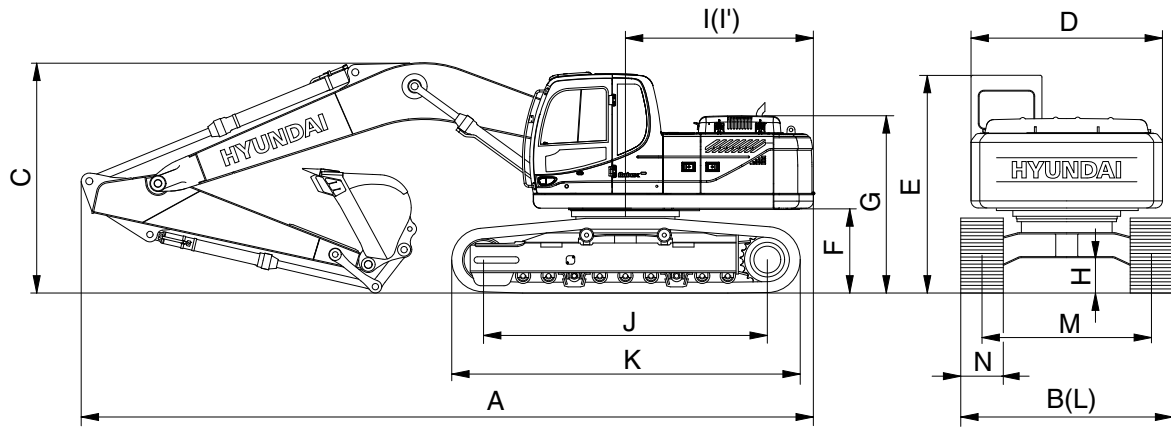

21092SP02

Description		Unit	Specification
Operating weight		kg (lb)	21900 (48280)
Bucket capacity (SAE heaped), standard		m ³ (yd ³)	0.92 (1.20)
Overall length	A	mm (ft-in)	9530 (31' 3")
Overall width, with 600mm shoe	B		2990 (9' 10")
Overall height	C		3030 (9' 11")
Superstructure width	D		2740 (9' 0")
Overall height of cab	E		3000 (9' 10")
Ground clearance of counterweight	F		1060 (3' 6")
Engine cover height	G		2320 (7' 7")
Minimum ground clearance	H		480 (1' 7")
Rear-end distance	I		2770 (9' 1")
Rear-end swing radius	I'		2840 (9' 4")
Distance between tumblers	J		3650 (12' 0")
Undercarriage length	K		4440 (14' 7")
Undercarriage width	L		2990 (9' 10")
Track gauge	M		2390 (7' 10")
Track shoe width, standard	N		600 (24")
Travel speed (low/high)		km/hr (mph)	3.8/5.5 (2.4/3.4)
Swing speed		rpm	11.1
Gradeability		Degree (%)	35 (70)
Ground pressure (600 mm shoe)		kgf/cm ² (psi)	0.46 (6.54)
Max traction force		kg (lb)	21100 (46500)

2) R220LC-9S LONG REACH

- 8.2 m (26' 11") BOOM and 6.3 m (20' 8") ARM

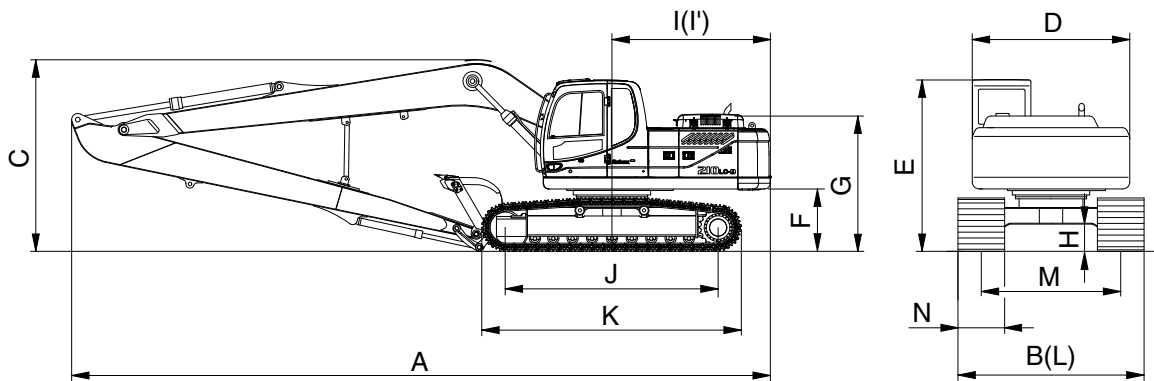

21092SP06

Description		Unit	Specification
Operating weight		kg (lb)	24360 (53700)
Bucket capacity (SAE heaped), standard		m ³ (yd ³)	0.52 (0.68)
Overall length	A	mm (ft-in)	12030 (39' 6")
Overall width, with 800 mm shoe	B		3190 (10' 6")
Overall height	C		3280 (10' 9")
Superstructure width	D		2740 (9' 0")
Overall height of cab	E		3000 (9' 10")
Ground clearance of counterweight	F		1060 (3' 6")
Engine cover height	G		2320 (7' 7")
Minimum ground clearance	H		480 (1' 7")
Rear-end distance	I		2770 (9' 1")
Rear-end swing radius	I'		2840 (9' 4")
Distance between tumblers	J		3650 (12' 0")
Undercarriage length	K		4440 (14' 7")
Undercarriage width	L		3190 (10' 6")
Track gauge	M		2390 (7' 10")
Track shoe width, standard	N		800 (32")
Travel speed (low/high)			km/hr (mph)
Swing speed		rpm	11.1
Gradeability		Degree (%)	35 (70)
Ground pressure (800 mm shoe)		kgf/cm ² (psi)	0.42 (5.97)
Max traction force		kg (lb)	21100 (46500)

3) R220LC-9S HIGH WALKER

- 5.68 m (18' 8") BOOM and 2.92 m (9' 7") ARM

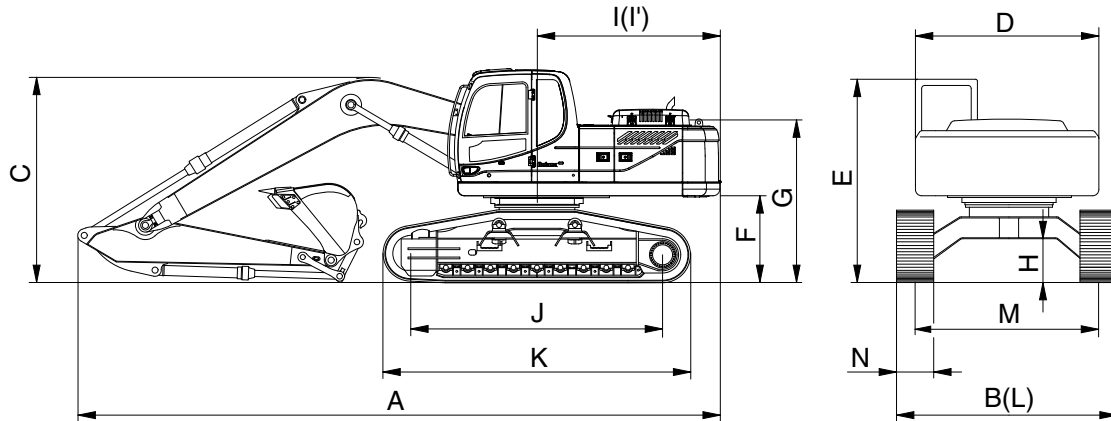

21092SP07

Description		Unit	Specification	
Operating weight		kg (lb)	23160 (51060)	
Bucket capacity (SAE heaped), standard		m ³ (yd ³)	0.92 (1.20)	
Overall length	A	mm (ft-in)	9470 (31' 1")	
Overall width, with 600 mm shoe	B		3395 (11' 2")	
Overall height	C		3060 (10' 0")	
Superstructure width	D		2740 (9' 0")	
Overall height of cab	E		3100 (10' 2")	
Ground clearance of counterweight	F		1240 (4' 1")	
Engine cover height	G		2500 (8' 2")	
Minimum ground clearance	H		660 (2' 2")	
Rear-end distance	I		2770 (9' 1")	
Rear-end swing radius	I'		2840 (9' 4")	
Distance between tumbler	J		3650 (12' 0")	
Undercarriage length	K		4440 (14' 7")	
Undercarriage width	L		3395 (11' 2")	
Track gauge	M		2795 (9' 2")	
Track shoe width, standard	N		600 (24")	
Travel speed (low/high)			km/hr (mph)	3.8/5.5 (2.4/3.4)
Swing speed			rpm	11.1
Gradeability		Degree (%)	35 (70)	
Ground pressure (600 mm shoe)		kgf/cm ² (psi)	0.49 (6.97)	
Max traction force		kg (lb)	21100 (46500)	

3. WORKING RANGE

1) R220LC-9S

· 5.68 m (18' 8") BOOM

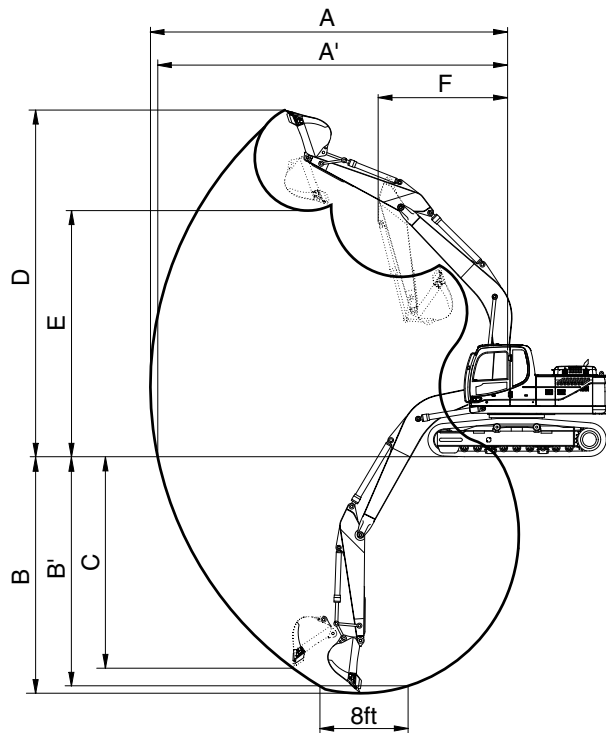

21092SP03

Description		2.0 m (6' 7") Arm	2.40 m (7' 10") Arm	2.92 m (9' 7") Arm	3.90 m (12' 10") Arm
Max digging reach	A	9140 mm (30' 0")	9500 mm (31' 2")	9980 mm (32' 9")	10910 mm (35' 10")
Max digging reach on ground	A'	8960 mm (29' 5")	9330 mm (30' 7")	9820 mm (32' 3")	10770 mm (35' 4")
Max digging depth	B	5820 mm (19' 1")	6220 mm (20' 5")	6730 mm (22' 1")	7720 mm (25' 4")
Max digging depth (8 ft level)	B'	5580 mm (18' 4")	6010 mm (19' 9")	6560 mm (21' 6")	7580 mm (24' 10")
Max vertical wall digging depth	C	5280 mm (17' 4")	5720 mm (18' 9")	6280 mm (20' 7")	7240 mm (23' 9")
Max digging height	D	9140 mm (30' 0")	9340 mm (30' 8")	9600 mm (31' 6")	10110 mm (33' 2")
Max dumping height	E	6330 mm (20' 9")	6520 mm (21' 5")	6780 mm (22' 3")	7290 mm (23' 11")
Min swing radius	F	3750 mm (12' 4")	3740 mm (12' 3")	3740 mm (12' 3")	3650 mm (12' 0")
Bucket digging force	SAE	133.4 [144.8] kN	133.4 [144.8] kN	133.4 [144.8] kN	133.4 [144.8] kN
		13600 [14770] kgf	13600 [14770] kgf	13600 [14770] kgf	13600 [14770] kgf
		29980 [32550] lbf	29980 [32550] lbf	29980 [32550] lbf	29980 [32550] lbf
	ISO	152.0 [165.0] kN	152.0 [165.0] kN	152.0 [165.0] kN	152.0 [165.0] kN
		15500 [16830] kgf	15500 [16830] kgf	15500 [16830] kgf	15500 [16830] kgf
		34170 [37100] lbf	34170 [37100] lbf	34170 [37100] lbf	34170 [37100] lbf
Arm digging force	SAE	144.2 [156.5] kN	119.6 [129.9] kN	102.0 [110.7] kN	84.3 [91.6] kN
		14700 [15960] kgf	12200 [13250] kgf	10400 [11290] kgf	8600 [9340] kgf
		32410 [35190] lbf	26900 [29210] lbf	22930 [24900] lbf	18960 [20590] lbf
	ISO	151.0 [164.0] kN	125.5 [136.3] kN	106.9 [116.1] kN	87.3 [94.8] kN
		15400 [16720] kgf	12800 [13900] kgf	10900 [11830] kgf	8900 [9660] kgf
		33950 [36860] lbf	28220 [30640] lbf	24030 [26090] lbf	19620 [21300] lbf

[] : Power boost

2) R220LC-9S LONG REACH

· 8.2 m (26' 11") BOOM

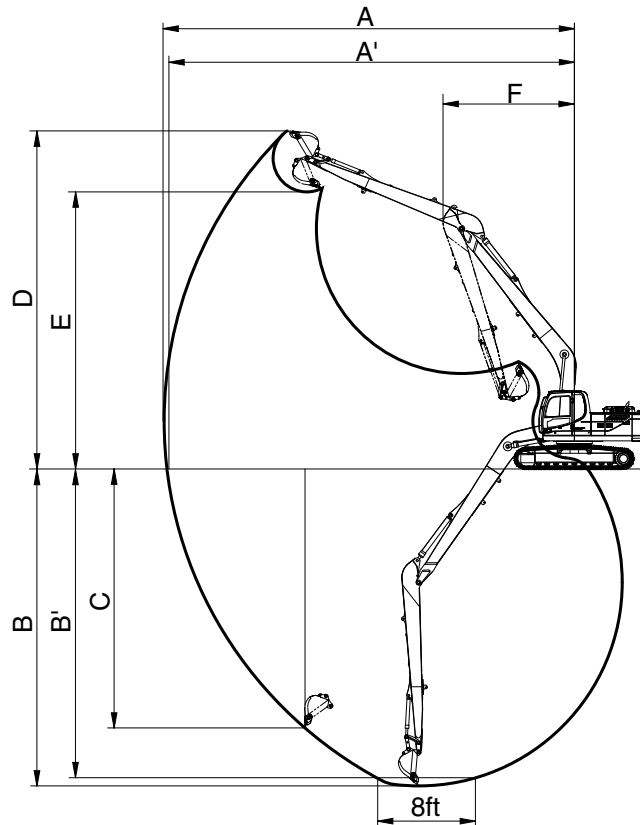

21092SP08

Description		6.3 m (20' 8") Arm	
Max digging reach	A	15220 (50' 0")	
Max digging reach on ground	A'	15120 (49' 7")	
Max digging depth	B	11760 (38' 7")	
Max digging depth (8 ft level)	B'	11650 (38' 3")	
Max vertical wall digging depth	C	9610 (31' 6")	
Max digging height	D	12550 (41' 2")	
Max dumping height	E	10280 (33' 8")	
Min swing radius	F	4870 (16' 0")	
Bucket digging force	SAE	72.6 kN	
		7400 kgf	
		16310 lbf	
	ISO	83.4 kN	
		8500 kgf	
		18740 lbf	
Arm crowd force	SAE	49.0 kN	
		5000 kgf	
		11020 lbf	
	ISO	50.0 kN	
		5100 kgf	
		11240 lbf	

3) R220LC-9S HIGH WALKER

· 5.68 m (18' 8") BOOM

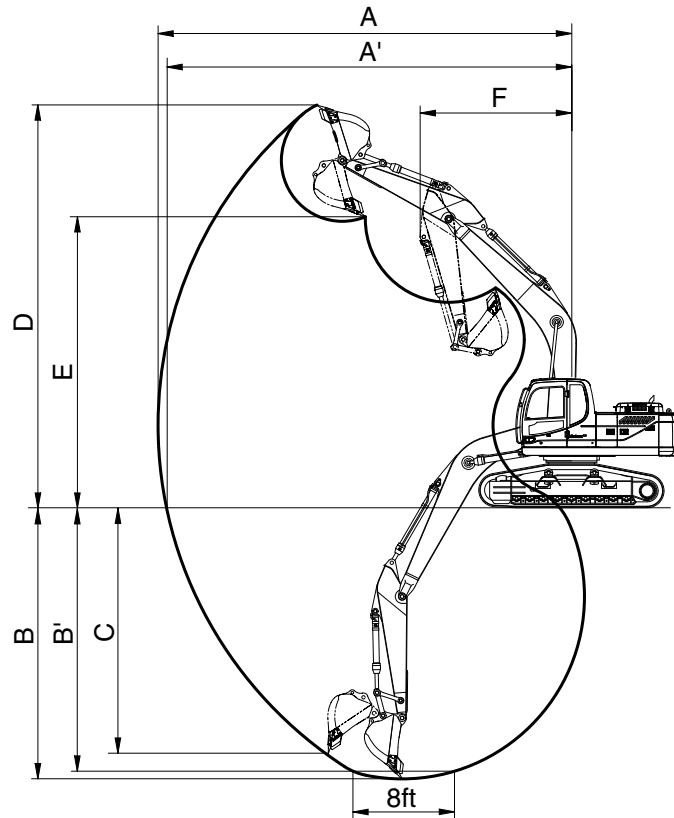

21092SP09

Description		2.0 m (6' 7") Arm	2.40 m (7' 10") Arm	2.92 m (9' 7") Arm	3.90 m (12'10") Arm
Max digging reach	A	9140 mm (30' 0")	9500 mm (31' 2")	9980 mm (32' 9")	10910 mm (35'10")
Max digging reach on ground	A'	8920 mm (29' 3")	9290 mm (30' 6")	9820 mm (32' 3")	10730 mm (35' 2")
Max digging depth	B	5630 mm (18' 6")	6010 mm (19' 9")	6550 mm (21' 6")	7530 mm (24' 8")
Max digging depth (8 ft level)	B'	5390 mm (17' 8")	5820 mm (19' 1")	6380 mm (20'11")	7390 mm (24' 3")
Max vertical wall digging depth	C	5090 mm (16' 8")	5630 mm (18' 6")	6100 mm (20' 0")	7050 mm (23' 1")
Max digging height	D	9330 mm (30' 7")	9530 mm (31' 3")	9780 mm (32' 1")	10300 mm (33' 9")
Max dumping height	E	6520 mm (21' 5")	6710 mm (22' 0")	6960 mm (22'10")	7480 mm (24' 6")
Min swing radius	F	3750 mm (12' 4")	3740 mm (12' 3")	3740 mm (12' 3")	3650 mm (12' 0")
Bucket digging force	SAE	133.4 [144.8] kN	133.4 [144.8] kN	133.4 [144.8] kN	133.4 [144.8] kN
		13600 [14770] kgf	13600 [14770] kgf	13600 [14770] kgf	13600 [14770] kgf
		29980 [32550] lbf	29980 [32550] lbf	29980 [32550] lbf	29980 [32550] lbf
	ISO	152.0 [165.0] kN	152.0 [165.0] kN	152.0 [165.0] kN	152.0 [165.0] kN
		15500 [16830] kgf	15500 [16830] kgf	15500 [16830] kgf	15500 [16830] kgf
		34170 [37100] lbf	34170 [37100] lbf	34170 [37100] lbf	34170 [37100] lbf
Arm crowd force	SAE	144.2 [156.5] kN	119.6 [129.9] kN	102.0 [110.7] kN	84.3 [91.6] kN
		14700 [15960] kgf	12200 [13250] kgf	10400 [11290] kgf	8600 [9340] kgf
		32410 [35190] lbf	26900 [29210] lbf	22930 [24900] lbf	18960 [20590] lbf
	ISO	151.0 [164.0] kN	125.5 [136.3] kN	106.9 [116.1] kN	87.3 [94.8] kN
		15400 [16720] kgf	12800 [13900] kgf	10900 [11830] kgf	8900 [9660] kgf
		33950 [36860] lbf	28220 [30640] lbf	24030 [26090] lbf	19620 [21300] lbf

[] : Power boost

4. WEIGHT

1) R220LC-9S

Item	R220LC-9S	
	kg	lb
Upperstructure assembly	9400	20720
Main frame weld assembly	1920	4230
Engine assembly	530	1170
Main pump assembly	140	310
Main control valve assembly	220	485
Swing motor assembly	240	530
Hydraulic oil tank assembly	240	530
Fuel tank assembly	195	430
Counterweight	3800	8380
Cab assembly	440	970
Lower chassis assembly	8700	19180
Track frame weld assembly	2720	6000
Swing bearing	290	640
Travel motor assembly	300	660
Turning joint	55	120
Track recoil spring	140	310
Idler	170	370
Carrier roller	20	45
Track roller	40	90
Track-chain assembly (600 mm standard triple grouser shoe)	1350	2980
Front attachment assembly (5.68 m boom, 2.92 m arm, 0.92 m ³ SAE heaped bucket)	4030	8880
5.68 m boom assembly	1520	3350
2.92 m arm assembly	750	1650
0.92 m ³ SAE heaped bucket	765	1690
Boom cylinder assembly	180	400
Arm cylinder assembly	290	640
Bucket cylinder assembly	175	390
Bucket control link assembly	170	370

2) R220LC-9S LONG REACH

Item	R220LC-9S LONG REACH	
	kg	lb
Upperstructure assembly	9400	20720
Main frame weld assembly	1920	4230
Engine assembly	530	1170
Main pump assembly	140	310
Main control valve assembly	220	485
Swing motor assembly	240	530
Hydraulic oil tank assembly	240	530
Fuel tank assembly	195	430
Counterweight	5300	11680
Cab assembly	440	970
Lower chassis assembly	8700	19180
Track frame weld assembly	2720	6000
Swing bearing	290	640
Travel motor assembly	300	660
Turning joint	55	120
Track recoil spring	140	310
Idler	170	370
Carrier roller	20	45
Track roller	40	90
Track-chain assembly (800 mm standard triple grouser shoe)	1660	3660
Front attachment assembly (8.2 m boom, 6.3 m arm, 0.52 m ³ SAE heaped bucket)	4600	10140
8.2 m boom assembly	2105	4640
6.3 m arm assembly	1100	2430
0.52 m ³ SAE heaped bucket	465	1030
Boom cylinder assembly	180	400
Arm cylinder assembly	270	600
Bucket cylinder assembly	130	290
Bucket control rod assembly	170	370













3) R220LC-9S HIGH WALKER

Item	R220LC-9S HIGH WALKER	
	kg	lb
Upperstructure assembly	9430	20790
Main frame weld assembly	1950	4300
Engine assembly	530	1170
Main pump assembly	140	310
Main control valve assembly	220	485
Swing motor assembly	240	530
Hydraulic oil tank assembly	240	530
Fuel tank assembly	195	430
Counterweight	3800	8380
Cab assembly	440	970
Lower chassis assembly	9015	19870
Track frame weld assembly	3730	8220
Swing bearing	290	640
Travel motor assembly	300	660
Turning joint	55	120
Track recoil spring	140	310
Idler	170	370
Carrier roller	20	45
Track roller	40	90
Track-chain assembly (600 mm standard triple grouser shoe)	1350	2980
Front attachment assembly (5.68 m boom, 2.92 m arm, 0.92 m ³ SAE heaped bucket)	4030	8880
5.68 m boom assembly	1520	3350
2.92 m arm assembly	750	1650
0.92 m ³ SAE heaped bucket	765	1690
Boom cylinder assembly	180	400
Arm cylinder assembly	290	640
Bucket cylinder assembly	175	390
Bucket control rod assembly	170	370

5. LIFTING CAPACITIES













1) ROBEX 220LC-9S

(1) 5.68 m (18' 8") boom, 2.92 m (9' 7") arm equipped with 0.92 m³ (SAE heaped) bucket, 600 mm (24") triple grouser shoe.

Load point height		Load radius										At max. reach		
		1.5 m (5 ft)		3.0 m (10 ft)		4.5 m (15 ft)		6.0 m (20 ft)		7.5 m (25 ft)		Capacity		Reach
														m (ft)
7.5 m (25 ft)	kg lb											*3360 *7410	3150 6940	7.78 (25.5)
6.0 m (20 ft)	kg lb									*2340 *5160	*2340 *5160	*3450 *7610	2460 5420	8.74 (28.7)
4.5 m (15 ft)	kg lb							*4010 *8840	*4010 *8840	*3830 *8440	3180 7010	*3580 *7890	2100 4630	9.32 (30.6)
3.0 m (10 ft)	kg lb			*9780 *21560	*9780 *21560	*6150 *13560	*6150 *13560	*4840 *10670	4460 9830	*4230 *9330	3040 6700	3440 7580	1930 4250	9.59 (31.5)
1.5 m (5 ft)	kg lb			*8810 *19420	*8810 *19420	*7960 *17550	6490 14310	*5750 *12680	4160 9170	*4710 *10380	2880 6350	3390 7470	1880 4140	9.59 (31.5)
Ground Line	kg lb			*9550 *21050	*9550 *21050	*9160 *20190	6090 13430	*6490 *14310	3920 8640	4930 10870	2750 6060	3520 7760	1950 4300	9.31 (30.5)
-1.5 m (-5 ft)	kg lb	*8810 *19420	*8810 *19420	*12610 *27800	11870 26170	*9600 *21160	5940 13100	*6870 *15150	3800 8380	4860 10710	2690 5930	3920 8640	2190 4830	8.72 (28.6)
-3.0 m (-10 ft)	kg lb	*12190 *26870	*12190 *26870	*13980 *30820	12040 26540	*9320 *20550	5960 13140	*6740 *14860	3800 8380			*4460 *9830	2710 5970	7.75 (25.4)
-4.5 m (-15 ft)	kg lb			*11860 *26150	*11860 *26150	*8120 *17900	6140 13540					*4330 *9550	4080 8990	6.16 (20.2)

- Note
1. Lifting capacity are based on SAE J1097 and ISO 10567.
 2. Lifting capacity of the ROBEX series does not exceed 75% of tipping load with the machine on firm, level ground or 87% of full hydraulic capacity.
 3. The load point is a hook located on the back of the bucket.
 4. *indicates load limited by hydraulic capacity.

(2) 5.68 m (18' 8") boom, 2.40 m (7' 10") arm equipped with 0.92 m³ (SAE heaped) bucket, 600 mm (24") triple grouser shoe.

















Load point height		Load radius										At max. reach		
		1.5 m (5 ft)		3.0 m (10 ft)		4.5 m (15 ft)		6.0 m (20 ft)		7.5 m (25 ft)		Capacity		Reach
														m (ft)
7.5 m (25 ft)	kg lb											*3700 *8160	3640 8020	7.15 (23.5)
6.0 m (20 ft)	kg lb							*4010 *8840	*4010 *8840			*3780 *8330	2760 6080	8.20 (26.9)
4.5 m (15 ft)	kg lb							*4490 *9900	*4490 *9900	*4230 *9330	3130 6900	*3900 *8600	2340 5160	8.82 (28.9)
3.0 m (10 ft)	kg lb					*6900 *15210	*6900 *15210	*5280 *11640	4400 9700	*4560 *10050	3010 6640	3760 8290	2130 4700	9.11 (29.9)
1.5 m (5 ft)	kg lb					*8560 *18870	6380 14070	*6120 *13490	4130 9110	*4970 *10960	2880 6350	3710 8180	2080 4590	9.10 (29.9)
Ground Line	kg lb			*8790 *19380	*8790 *19380	*9490 *20920	6080 13400	*6740 *14860	3930 8660	4950 10910	2780 6130	3890 8580	2180 4810	8.81 (28.9)
-1.5 m (-5 ft)	kg lb	*9760 *21520	*9760 *21520	*13510 *29780	12060 26590	*9650 *21270	6000 13230	*6960 *15340	3850 8490			4390 9680	2480 5470	8.18 (26.8)
-3.0 m (-10 ft)	kg lb	*14150 *31200	*14150 *31200	*13240 *29190	12280 27070	*9090 *20040	6080 13400	*6590 *14530	3900 8600			*4700 *10360	3190 7030	7.12 (23.4)
-4.5 m (-15 ft)	kg lb			*10630 *23440	*10630 *23440	*7400 *16310	6330 13960							

2) R220LC-9S LONG REACH

(1) 8.2 m (26' 11") boom, 6.3 m (20' 8") arm equipped with 0.52 m³ (0.68yd³)(SAE heaped) bucket, 800 mm (32") triple grouser shoe.

•  : Rating over-front













•  : Rating over-side or 360 degree

Load point height		Load radius														At max. reach			
		4.5 m (15.0 ft)		6.0 m (20.0ft)		7.5 m (25.0 ft)		9.0 m (30.0 ft)		10.5 m (35.0 ft)		12.0 m (40.0 ft)		13.5 m (45.0 ft)		Capacity		Reach	
																		m (ft)	
10.5 m	kg																*1480	*1480	12.11
35.0 ft	lb																*3260	*3260	(39.7)
9.0 m	kg											*930	*930				*1510	*1510	13.11
30.0 ft	lb											*2050	*2050				*3330	*3330	(43.0)
7.5 m	kg											*1550	*1550				*1550	1320	13.84
25.0 ft	lb											*3420	*3420				*3420	2910	(45.4)
6.0 m	kg									*1600	*1600	*1610	*1610				*1600	1160	14.37
20.0 ft	lb									*3530	*3530	*3550	*3550				*3530	2560	(47.1)
4.5 m	kg									*1790	*1790	*1730	1720	*1260	*1260		*1660	1050	14.72
15.0 ft	lb									*3950	*3950	*3810	3790	*2780	*2780		*3660	2310	(48.3)
3.0 m	kg					*2520	*2520	*2220	*2220	*2020	*2020	*1880	1630	*1590	1220		*1720	980	14.89
10.0 ft	lb					*5560	*5560	*4890	*4890	*4450	*4450	*4140	3590	*3510	2690		*3790	2160	(48.9)
1.5 m	kg	*5620	*5620	*3940	*3940	*3090	*3090	*2590	*2590	*2270	2000	*2050	1530	*1790	1170		*1800	940	14.90
5.0 ft	lb	*12390	*12390	*8690	*8690	*6810	*6810	*5710	*5710	*5000	4410	*4520	3370	*3950	2580		*3970	2070	(48.9)
Ground /line	kg	*6990	6720	*4770	4490	*3620	3240	*2950	2430	*2510	1860	*2220	1440	*1820	1110		1880	930	14.75
	lb	*15410	14820	*10520	9900	*7980	7140	*6500	5360	*5530	4100	*4890	3170	*4010	2450		4140	2050	(48.4)
-1.5 m	kg	*7830	6210	*5390	4120	*4060	2990	*3260	2260	*2740	1740	*2380	1360	*1570	1070		1930	960	14.42
-5.0 ft	lb	*17260	13690	*11880	9080	*8950	6590	*7190	4980	*6040	3840	*5250	3000	*3460	2360		4250	2120	(47.3)
-3.0 m	kg	*8230	5990	*5780	3920	*4370	2830	*3490	2140	*2900	1660	*2490	1310				2030	1020	13.92
-10.0 ft	lb	*18140	13210	*12740	8640	*9630	6240	*7690	4720	*6390	3660	*5490	2890				4480	2250	(45.7)
-4.5 m	kg	*8310	5940	*5950	3830	*4540	2740	*3630	2070	*3000	1620	2510	1290				*2210	1140	13.20
-15.0 ft	lb	*18320	13100	*13120	8440	*10010	6040	*8000	4560	*6610	3570	5530	2840				*4870	2510	(43.3)
-6.0 m	kg	*8100	6010	*5900	3840	*4550	2730	*3640	2060	*2970	1620						*2340	1330	12.25
-20.0 ft	lb	*17860	13250	*13010	8470	*10030	6020	*8020	4540	*6550	3570						*5160	2930	(40.2)
-7.5 m	kg	*7580	6180	*5610	3930	*4350	2790	*3460	2120	*2740	1690						*2460	1670	10.97
-25.0 ft	lb	*16710	13620	*12370	8660	*9590	6150	*7630	4670	*6040	3730						*5420	3680	(36.0)
-9.0 m	kg	*6650	6460	*4980	4110	*3840	2940	*2930	2260										
-30.0 ft	lb	*14660	14240	*10980	9060	*8470	6480	*6460	4980										
-10.5 m	kg	*5040	*5040	*3730	*3730														
-35.0 ft	lb	*11110	*11110	*8220	*8220														

- Note
1. Lifting capacity are based on SAE J1097 and ISO 10567.
 2. Lifting capacity of the ROBEX series does not exceed 75% of tipping load with the machine on firm, level ground or 87% of full hydraulic capacity.
 3. The load point is a hook located on the back of the bucket.
 4. *indicates load limited by hydraulic capacity.













3) R220LC-9S HIGH WALKER

(1) 5.68 m (18' 8") boom, 2.92 m (9' 7") arm equipped with 0.92 m³ (SAE heaped) bucket, 600 mm (24") triple grouser shoe.

Load point height		Load radius										At max. reach		
		1.5 m (5 ft)		3.0 m (10 ft)		4.5 m (15 ft)		6.0 m (20 ft)		7.5 m (25 ft)		Capacity		Reach
														m (ft)
7.5 m (25 ft)	kg lb											*3370 *7430	*3370 *7430	7.93 (26.0)
6.0 m (20 ft)	kg lb								*2700 *5950	*2700 *5950		*3460 *7630	3130 6900	8.83 (29.0)
4.5 m (15 ft)	kg lb							*4110 *9060	*4110 *9060	*3870 *8530	*3870 *8530	*3600 *7940	2740 6040	9.37 (30.7)
3.0 m (10 ft)	kg lb			*10440 *23020	*10440 *23020	*6400 *14110	*6400 *14110	*4960 *10930	*4960 *10930	*4290 *9460	3930 8660	3680 8110	2560 5640	9.60 (31.5)
1.5 m (5 ft)	kg lb			*8610 *18980	*8610 *18980	*8150 *17970	*8150 *17970	*5860 *12920	5380 11860	*4760 *10490	3770 8310	3650 8050	2530 5580	9.57 (31.4)
Ground Line	kg lb			*9870 *21760	*9870 *21760	*9260 *20410	8080 17810	*6560 *14460	5150 11350	*5150 *11350	3640 8020	3820 8420	2650 5840	9.25 (30.3)
-1.5 m (-5 ft)	kg lb	*9210 *20300	*9210 *20300	*13090 *28860	*13090 *28860	*9600 *21160	7940 17500	*6880 *15170	5040 11110	5200 11460	3590 7910	4280 9440	2980 6570	8.62 (28.3)
-3.0 m (-10 ft)	kg lb	*12660 *27910	*12660 *27910	*13780 *30380	*13780 *30380	*9230 *20350	7990 17610	*6670 *14700	5060 11160			*4470 *9850	3710 8180	7.59 (24.9)
-4.5 m (-15 ft)	kg lb			*11470 *25290	*11470 *25290	*7860 *17330	*7860 *17330					*4250 *9370	*4250 *9370	5.89 (19.3)

- Note
1. Lifting capacity are based on SAE J1097 and ISO 10567.
 2. Lifting capacity of the ROBEX series does not exceed 75% of tipping load with the machine on firm, level ground or 87% of full hydraulic capacity.
 3. The load point is a hook located on the back of the bucket.
 4. *indicates load limited by hydraulic capacity.

(2) 5.68 m (18' 8") boom, 2.4 m (7' 10") arm equipped with 0.92 m³ (SAE heaped) bucket, 600 mm (24") triple grouser shoe.

Load point height		Load radius										At max. reach		
		1.5 m (5 ft)		3.0 m (10 ft)		4.5 m (15 ft)		6.0 m (20 ft)		7.5 m (25 ft)		Capacity		Reach
														m (ft)
7.5 m (25 ft)	kg lb											*3700 *8160	*3700 *8160	7.31 (24.0)
6.0 m (20 ft)	kg lb							*4050 *8930	*4050 *8930			*3790 *8360	3480 7670	8.30 (27.2)
4.5 m (15 ft)	kg lb					*5360 *11820	*5360 *11820	*4580 *10100	*4580 *10100	*4260 *9390	4030 8880	*3920 *8640	3020 6660	8.87 (29.1)
3.0 m (10 ft)	kg lb					*7130 *15720	*7130 *15720	*5390 *11880	*5390 *11880	*4610 *10160	3900 8600	4010 8840	2810 6190	9.12 (29.9)
1.5 m (5 ft)	kg lb					*8720 *19220	8370 18450	*6220 *13710	5360 11820	*5020 *11070	3770 8310	3990 8800	2780 6130	9.08 (29.8)
Ground Line	kg lb			*9350 *20610	*9350 *20610	*9550 *21050	8080 17810	*6790 *14970	5170 11400	5290 11660	3670 8090	4210 9280	2940 6480	8.75 (28.7)
-1.5 m (-5 ft)	kg lb	*10290 *22690	*10290 *22690	*14180 *31260	*14180 *31260	*9620 *21210	8020 17680	*6950 *15320	5100 11240			*4650 *10250	3360 7410	8.07 (26.5)
-3.0 m (-10 ft)	kg lb	*14760 *32540	*14760 *32540	*12990 *28640	*12990 *28640	*8950 *19730	8120 17900	*6470 *14260	5170 11400			*4690 *10340	4350 9590	6.94 (22.8)
-4.5 m (-15 ft)	kg lb			*10150 *22380	*10150 *22380	*7020 *15480	*7020 *15480							

6. BUCKET SELECTION GUIDE

1) GENERAL BUCKET

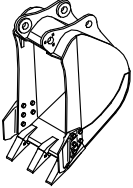
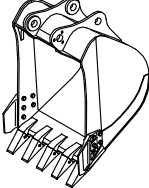
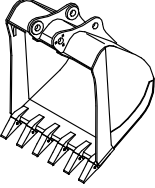
		
0.51 m ³ SAE heaped bucket	※0.92, ★0.52, 0.80, 0.87, 1.10, 1.20 m ³ SAE heaped bucket	1.34 m ³ SAE heaped bucket

Capacity		Width		Weight	Recommendation				
					5.68 m (18' 8") boom				8.2m (26' 11") boom
SAE heaped	CECE heaped	Without side cutter	With side cutter		2.0 m arm (6' 7")	2.4 m arm (7' 10")	2.92 m arm (9' 7")	3.90 m arm (12' 10")	6.3 m arm (20' 8")
0.51 m ³ (0.67 yd ³)	0.45 m ³ (0.59 yd ³)	700 mm (27.6")	820 mm (32.3")	570 kg (1260 lb)					
★0.52 m ³ (0.68 yd ³)	0.45 m ³ (0.59 yd ³)	935 mm (36.8")	1035 mm (40.7")	460 kg (1010 lb)					
0.80 m ³ (1.05 yd ³)	0.70 m ³ (0.92 yd ³)	1000 mm (39.4")	1120 mm (44.1")	770 kg (1700 lb)					
0.87 m ³ (1.14 yd ³)	0.75 m ³ (0.98 yd ³)	1090 mm (42.9")	1210 mm (47.6")	740 kg (1630 lb)					
※0.92 m ³ (1.20 yd ³)	0.80 m ³ (1.05 yd ³)	1150 mm (45.3")	1270 mm (50.0")	770 kg (1700 lb)					
1.10 m ³ (1.44 yd ³)	0.96 m ³ (1.26 yd ³)	1320 mm (52.0")	1440 mm (56.7")	830 kg (1830 lb)					
1.20 m ³ (1.57 yd ³)	1.00 m ³ (1.31 yd ³)	1400 mm (55.1")	1520 mm (59.8")	850 kg (1870 lb)					
1.34 m ³ (1.75 yd ³)	1.15 m ³ (1.50 yd ³)	1550 mm (61.0")	1670 mm (65.7")	920 kg (2030 lb)					

※ : Standard bucket

★ : Long reach bucket

Applicable for materials with density of 2000 kgf/m³ (3370 lbf/yd³) or less

Applicable for materials with density of 1600 kgf/m³ (2700 lbf/yd³) or less

Applicable for materials with density of 1100 kgf/m³ (1850 lbf/yd³) or less

2) HEAVY DUTY, ROCK-HEAVY DUTY AND SLOPE FINISHING BUCKET

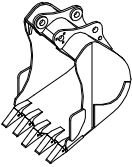
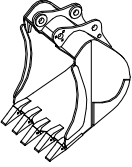
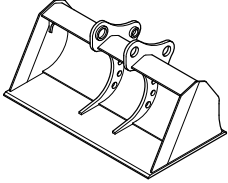
Heavy duty bucket	Rock-heavy duty bucket	Slope finishing bucket
		
◆ 0.74, 0.90, 1.05 m ³ SAE heaped bucket	◎ 0.87, 1.20 m ³ SAE heaped bucket	■ 0.75 m ³ SAE heaped bucket

Capacity		Width		Weight	Recommendation			
SAE heaped	CECE heaped	Without side cutter	With side cutter		5.68 m (18' 8") boom			
					2.0 m arm (6' 7")	2.4 m arm (7' 10")	2.92 m arm (9' 7")	3.90 m arm (12' 10")
◆0.74 m ³ (0.97 yd ³)	0.65 m ³ (0.85 yd ³)	985 mm (38.8")	-	770 kg (1700 lb)				
◆0.90 m ³ (1.18 yd ³)	0.80 m ³ (1.05 yd ³)	1070 mm (42.0")	-	810 kg (1790 lb)				
◆1.05 m ³ (1.37 yd ³)	0.92 m ³ (1.20 yd ³)	1290 mm (50.8")	-	890 kg (1960 lb)				
◎0.87 m ³ (1.14 yd ³)	0.75 m ³ (0.98 yd ³)	1140 mm (44.9")	-	900 kg (1980 lb)				
◎1.20 m ³ (1.57 yd ³)	1.00 m ³ (1.31 yd ³)	1410 mm (55.5")	-	1030 kg (2270 lb)				
■0.75 m ³ (0.98 yd ³)	0.65 m ³ (0.85 yd ³)	1790 mm (70.5")	-	880 kg (1940 lb)				

◆ : Heavy duty bucket ◎ : Rock-heavy duty bucket ■ : Slope finishing bucket

 Applicable for materials with density of 2000 kgf/m³ (3370 lbf/yd³) or less

 Applicable for materials with density of 1600 kgf/m³ (2700 lbf/yd³) or less

 Applicable for materials with density of 1100 kgf/m³ (1850 lbf/yd³) or less

7. UNDERCARRIAGE

1) TRACKS

X-leg type center frame is integrally welded with reinforced box-section track frames. The design includes dry tracks, lubricated rollers, idlers, sprockets, hydraulic track adjusters with shock absorbing springs and assembled track-type tractor shoes with triple grousers.

2) TYPES OF SHOES

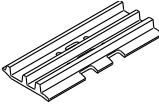
Model	Shapes		Triple grouser			
						
R220LC-9S	Shoe width	mm (in)	600 (24)	700 (28)	800 (32)	900 (36)
	Operating weight	kg (lb)	21900 (48280)	22250 (49050)	22515 (49640)	22760 (50180)
	Ground pressure	kgf/cm ² (psi)	0.46 (6.54)	0.40 (5.69)	0.36 (5.12)	0.32 (4.55)
	Overall width	mm (ft-in)	2990 (9' 10")	3090 (10' 2")	3190 (10' 6")	3290 (10' 10")
R220LC-9S LONG REACH	Shoe width	mm (in)	-	-	800 (32)	-
	Operating weight	kg (lb)	-	-	24605 (54240)	-
	Ground pressure	kgf/cm ² (psi)	-	-	0.39 (5.55)	-
	Overall width	mm (ft-in)	-	-	3190 (10' 6")	-
R220LC-9S HIGH WALKER	Shoe width	mm (in)	600 (24)	700 (28)	800 (32)	710 (28)*
	Operating weight	kg (lb)	23360 (51500)	23710 (52270)	23975 (52860)	24220 (53400)
	Ground pressure	kgf/cm ² (psi)	0.50 (7.11)	0.43 (6.11)	0.38 (5.40)	0.43 (6.11)
	Overall width	mm (ft-in)	3395 (11' 2")	3495 (11' 6")	3595 (11' 10")	3505 (11' 6")

* : Double grouser

3) NUMBER OF ROLLERS AND SHOES ON EACH SIDE

Item	Quantity
Carrier rollers	2 EA
Track rollers	9 EA
Track shoes	49 EA

4) SELECTION OF TRACK SHOE

Suitable track shoes should be selected according to operating conditions.

Method of selecting shoes

Confirm the category from the list of applications in **table 2**, then use **table 1** to select the shoe. Wide shoes (categories B and C) have limitations on applications. Before using wide shoes, check the precautions, then investigate and study the operating conditions to confirm if these shoes are suitable.

Select the narrowest shoe possible to meet the required flotation and ground pressure. Application of wider shoes than recommendations will cause unexpected problem such as bending of shoes, crack of link, breakage of pin, loosening of shoe bolts and the other various problems.

※ **Table 1**

Track shoe	Specification	Category
600 mm triple grouser	Standard	A
700 mm triple grouser	Option	B
800 mm triple grouser	Option	C
800 mm triple grouser (long reach)	Standard	C
900 mm triple grouser	Option	C

※ **Table 2**

Category	Applications	Precautions
A	Rocky ground, river beds, normal soil	<ul style="list-style-type: none"> • Travel at low speed on rough ground with large obstacles such as boulders or fallen trees
B	Normal soil, soft ground	<ul style="list-style-type: none"> • These shoes cannot be used on rough ground with large obstacles such as boulders or fallen trees • Travel at high speed only on flat ground • Travel slowly at low speed if it is impossible to avoid going over obstacles
C	Extremely soft ground (swampy ground)	<ul style="list-style-type: none"> • Use the shoes only in the conditions that the machine sinks and it is impossible to use the shoes of category A or B • These shoes cannot be used on rough ground with large obstacles such as boulders or fallen trees • Travel at high speed only on flat ground • Travel slowly at low speed if it is impossible to avoid going over obstacles

8. SPECIFICATIONS FOR MAJOR COMPONENTS

1) ENGINE

Item	Specification
Model	Cummins 6BTAA / HYUNDAI HM5.9
Type	4-cycle turbocharged diesel engine, low emission
Cooling method	Water cooling
Number of cylinders and arrangement	6 cylinders, in-line
Firing order	1-5-3-6-2-4
Combustion chamber type	Direct injection type
Cylinder bore × stroke	102 × 120 mm (4.02" × 4.72")
Piston displacement	5900 cc (360 cu in)
Compression ratio	17.3 : 1
Rated gross horse power (SAE J1995)	150 Hp at 1950 rpm (112 kW at 1950 rpm)
Maximum torque at 1500 rpm	62.6 kgf · m (453 lbf · ft)
Engine oil quantity	24 l (6.3 U.S. gal)
Dry weight	496 kg (1094 lb)
High idling speed	2150 ± 50 rpm
Low idling speed	1050 ± 100 rpm
Rated fuel consumption	164.8 g/Hp · hr at 1950 rpm
Starting motor	Nippon denso (24 V-4.5 kW)
Alternator	Delco Remy (24 V-90 A)
Battery	2 × 12 V × 100 Ah

2) MAIN PUMP

Item	Specification
Type	Variable displacement tandem axis piston pumps
Capacity	2 × 117cc/rev
Maximum pressure	350kgf/cm ² (4980psi) [380 kgf/cm ² (5400 psi)]
Rated oil flow	2 × 222 l /min (58.6U.S. gpm/ 48.8U.K. gpm)
Rated speed	1950 rpm

[] : Power boost

3) GEAR PUMP

Item	Specification
Type	Fixed displacement gear pump single stage
Capacity	15 cc/rev
Maximum pressure	40 kgf/cm ² (570 psi)
Rated oil flow	28.5 l /min (7.5 U.S. gpm/6.3 U.K. gpm)

4) MAIN CONTROL VALVE

Item	Specification	
	R220LC-9S	R220LC-9S Long reach & Amphibious
Type	9 spools two-block	
Operating method	Hydraulic pilot system	
Main relief valve pressure	350 kgf/cm ² (4980 psi) [380 kgf/cm ² (5400 psi)]	350 kgf/cm ² (4980 psi)
Port relief valve pressure	Boom	400 kgf/cm ² (5690 psi)
	Arm	400 kgf/cm ² (5690 psi) 300 kgf/cm ² (4270 psi)
	Bucket	400 kgf/cm ² (5690 psi) 280 kgf/cm ² (3980 psi)

[]: Power boost

5) SWING MOTOR

Item	Specification
Type	Two fixed displacement axial piston motor
Capacity	151 cc/rev
Relief pressure	265 kgf/cm ² (3770 psi)
Braking system	Automatic, spring applied hydraulic released
Braking torque	59 kgf · m (427 lbf · ft)
Brake release pressure	33~50 kgf/cm ² (470~711 psi)
Reduction gear type	2 - stage planetary

6) TRAVEL MOTOR

Item	Specification
Type	Variable displacement axial piston motor
Relief pressure	350 kgf/cm ² (4980 psi)
Reduction gear type	2-stage planetary
Braking system	Automatic, spring applied hydraulic released
Brake release pressure	11 kgf/cm ² (156 psi)
Braking torque	49.3 kgf · m (357 lbf · ft)

7) REMOTE CONTROL VALVE

Item		Specification
Type		Pressure reducing type
Operating pressure	Minimum	6.5 kgf/cm ² (92 psi)
	Maximum	25 kgf/cm ² (356 psi)
Single operation stroke	Lever	90 mm (3.5 in)
	Pedal	130 mm (4.4 in)

8) CYLINDER

Item		Specification
Boom cylinder	Bore dia × Rod dia × Stroke	∅ 120 × ∅ 85 × 1290 mm
	Cushion	Extend only
Arm cylinder	Bore dia × Rod dia × Stroke	∅ 140 × ∅ 100 × 1510 mm # ∅ 140 × ∅ 100 × 1460 mm
	Cushion	Extend and retract
Bucket cylinder	Bore dia × Rod dia × Stroke	∅ 120 × ∅ 85 × 1055 mm # ∅ 100 × ∅ 70 × 870 mm
	Cushion	Extend only

※ Discoloration of cylinder rod can occur when the friction reduction additive of lubrication oil spreads on the rod surface.

※ Discoloration does not cause any harmful effect on the cylinder performance.

: LONG REACH

9) SHOE

Item		Width	Ground pressure	Link quantity	Overall width
R220LC-9S	Standard	600 mm (24")	0.46 kgf/cm ² (6.54 psi)	49	2990 mm (9' 10")
	Option	700 mm (28")	0.40 kgf/cm ² (5.69 psi)	49	3090 mm (10' 2")
		800 mm (32")	0.36 kgf/cm ² (5.12 psi)	49	3190 mm (10' 6")
		900 mm (36")	0.32 kgf/cm ² (4.55 psi)	49	3290 mm (10' 10")
R220LC-9S LONG REACH	Standard	800 mm (32")	0.39 kgf/cm ² (5.55 psi)	49	3190 mm (10' 6")
R220LC-9S HIGH WALKER	Standard	600 mm (24")	0.50 kgf/cm ² (7.11 psi)	49	3395 mm (11' 2")
	Option	700 mm (28")	0.43 kgf/cm ² (6.11 psi)	49	3495 mm (11' 6")
		800 mm (32")	0.38 kgf/cm ² (5.40 psi)	49	3595 mm (11' 10")
		※ 710 mm (28")	0.43 kgf/cm ² (6.11 psi)	49	3505 mm (11' 6")

※ : Double grouser

10) BUCKET

Item	Capacity		Tooth quantity	Width	
	SAE heaped	CECE heaped		Without side cutter	With side cutter
R220LC-9S	0.51 m ³ (0.67 yd ³)	0.45 m ³ (0.59 yd ³)	3	700 mm (27.6")	820 mm (32.3")
	0.80 m ³ (1.05 yd ³)	0.70 m ³ (0.92 yd ³)	5	1000 mm (39.4")	1120 mm (44.1")
	0.87 m ³ (1.14 yd ³)	0.75 m ³ (0.98 yd ³)	5	1090 mm (42.9")	1210 mm (47.6")
	0.92 m ³ (1.20 yd ³)	0.80 m ³ (1.05 yd ³)	5	1150 mm (45.3")	1270 mm (50.0")
	1.10 m ³ (1.44 yd ³)	0.96 m ³ (1.26 yd ³)	5	1320 mm (52.0")	1440 mm (56.7")
	1.20 m ³ (1.57 yd ³)	1.00 m ³ (1.31 yd ³)	5	1400 mm (55.1")	1520 mm (59.8")
	1.34 m ³ (1.75 yd ³)	1.15 m ³ (1.50 yd ³)	6	1550 mm (61.0")	1670 mm (65.7")
	★0.52 m ³ (0.68 yd ³)	0.45 m ³ (0.59 yd ³)	5	935 mm (36.8")	1035 mm (40.7")
	◆0.74 m ³ (0.97 yd ³)	0.65 m ³ (0.85 yd ³)	5	985 mm (38.8")	-
	◆0.90 m ³ (1.18 yd ³)	0.80 m ³ (1.05 yd ³)	5	1070 mm (42.0")	-
	◆1.05 m ³ (1.37 yd ³)	0.92 m ³ (1.20 yd ³)	5	1290 mm (50.8")	-
	◎0.87 m ³ (1.14 yd ³)	0.75 m ³ (0.98 yd ³)	5	1140 mm (44.9")	-
	◎1.20 m ³ (1.57 yd ³)	1.00 m ³ (1.31 yd ³)	5	1410 mm (55.5")	-
	■0.75 m ³ (0.98 yd ³)	0.65 m ³ (0.85 yd ³)	-	1790 mm (70.5")	-

★ : Long reach bucket

◆ : Heavy duty bucket

◎ : Rock-heavy duty bucket

■ : Slope finishing bucket

9. RECOMMENDED OILS

Use only oils listed below. Do not mix different brand oil.

Please use HYUNDAI genuine oil and grease.

Service point	Kind of fluid	Capacity l (U.S. gal)	Ambient temperature °C (°F)						
			-40 (-40)	-30 (-22)	-20 (-4)	-10 (14)	0 (32)	10 (50)	20 (68)
Engine oil pan	Engine oil	24 (6.3)	★SAE 0W-30						
			SAE 30						
			SAE 10W						
			SAE 10W-30						
			SAE 15W-40						
Swing drive	Gear oil	5.0 (1.3)	★SAE 75W-90						
Final drive		5.8×2 (1.5×2)	SAE 80W-90						
Hydraulic tank	Hydraulic oil	Tank; 160 (42)	★ISO VG 15						
			ISO VG 32						
		System; 275 (73)	ISO VG 46						
			ISO VG 68						
Fuel tank	Diesel fuel	400 (106)	★ASTM D975 NO.1						
			ASTM D975 NO.2						
Fitting (grease nipple)	Grease	As required	★NLGI NO.1						
			NLGI NO.2						
Radiator (reservoir tank)	Mixture of antifreeze and water	35 (9.2)	Ethylene glycol base permanent type (50 : 50)						
			★Ethylene glycol base permanent type (60 : 40)						

SAE : Society of Automotive Engineers

★ : Arctic machine

API : American Petroleum Institute

ISO : International Organization for Standardization

NLGI : National Lubricating Grease Institute

ASTM : American Society of Testing and Material