

GROUP 8 TURNING JOINT

1. REMOVAL AND INSTALL

1) REMOVAL

- (1) Lower the work equipment to the ground and stop the engine.
- (2) Operate the control levers and pedals several times to release the remaining pressure in the hydraulic piping.
- (3) Loosen the breather slowly to release the pressure inside the hydraulic tank.

▲ **Escaping fluid under pressure can penetrate the skin causing serious injury.**

※ When pipes and hoses are disconnected, the oil inside the piping will flow out, so catch it in oil pan.

- (4) Disconnect all hoses.
- (5) Sling the turning joint assembly (1) and remove the mounting bolt (2).
 - Weight : 55 kg (120 lb)
 - Tightening torque : $12.3 \pm 1.3 \text{ kgf} \cdot \text{m}$
($88.9 \pm 9.4 \text{ lbf} \cdot \text{ft}$)
- (6) Remove the turning joint assembly.

※ When removing the turning joint, check that all the hoses have been disconnected.

2) INSTALL

- (1) Carry out installation in the reverse order to removal.
 - ※ Take care of turning joint direction.
 - ※ Assemble hoses to their original positions.
 - ※ Confirm the hydraulic oil level and check the hydraulic oil leak or not.

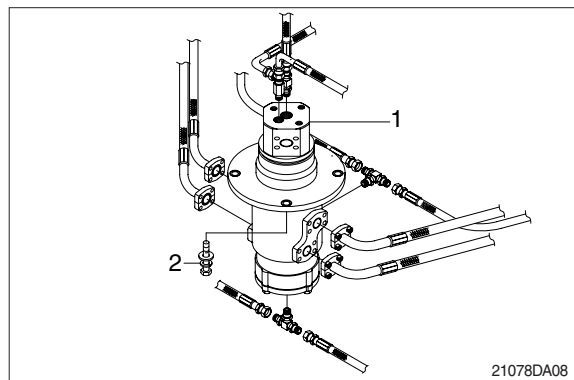
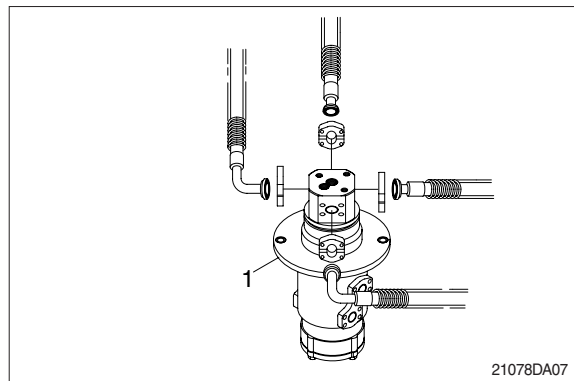

2. DISASSEMBLY AND ASSEMBLY

1) STRUCTURE

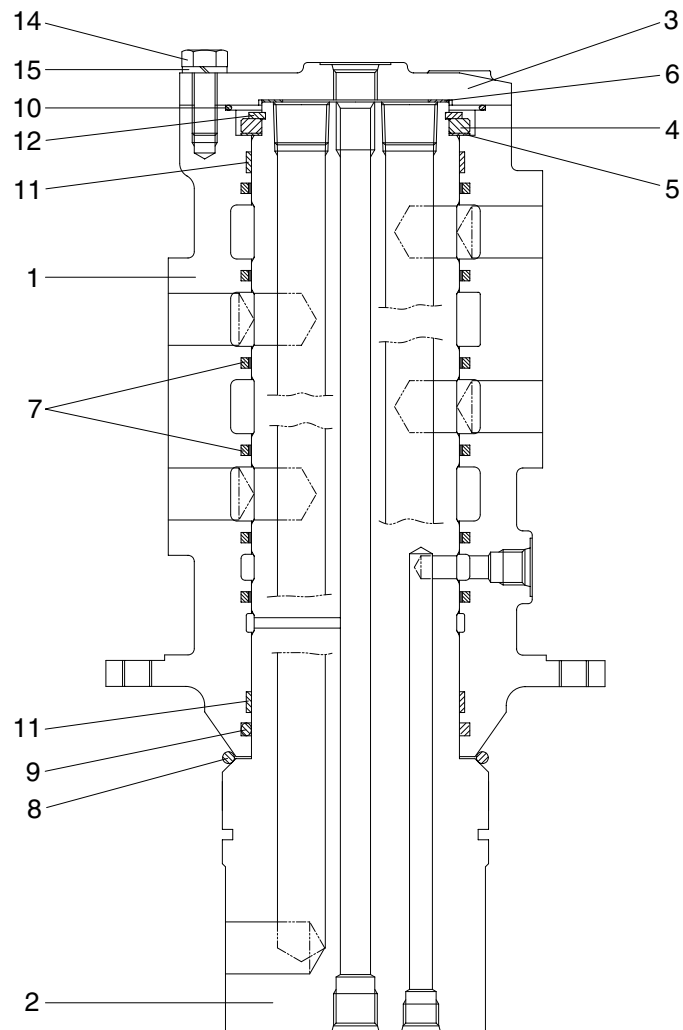

21098TJ01

- | | | | | | |
|---|--------|----|--------------|----|---------------|
| 1 | Hub | 6 | Shim | 11 | Wear ring |
| 2 | Shaft | 7 | Slipper seal | 12 | Retainer ring |
| 3 | Cover | 8 | O-ring | 13 | Plug |
| 4 | Spacer | 9 | O-ring | 14 | Hexagon bolt |
| 5 | Shim | 10 | O-ring | 15 | Spring washer |

2) DISASSEMBLY

※ Before the disassembly, clean the turning joint.

- (1) Remove bolts (14), washer (15) and cover (3).

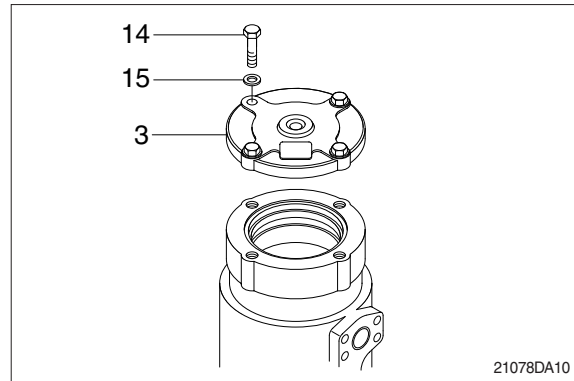

- (2) Remove shim (6) and O-ring (10).

- (3) Remove retainer ring (12), spacer (4) and shim (5).

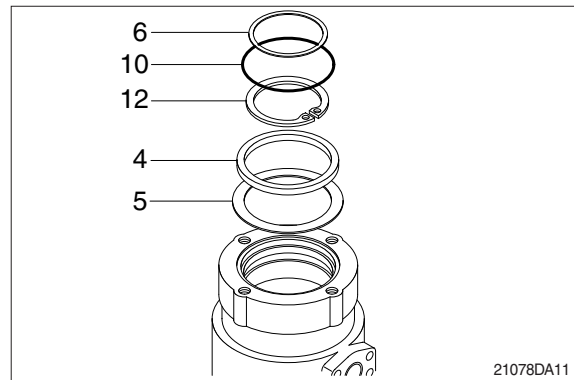

- (4) Place hub (1) on a V-block and by using a wood buffer at the shaft end, hit out shaft (2) to about 1/2 from the body with a hammer.

※ Take care not to damage the shaft (2) when remove hub (1) or rest it sideways.
 ※ Put a fitting mark on hub (1) and shaft (2).

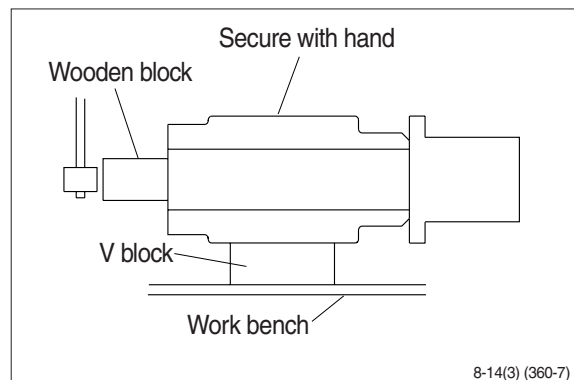

- (5) Remove six slipper seals (7) and O-ring (9), two wear ring (11) from hub (1).

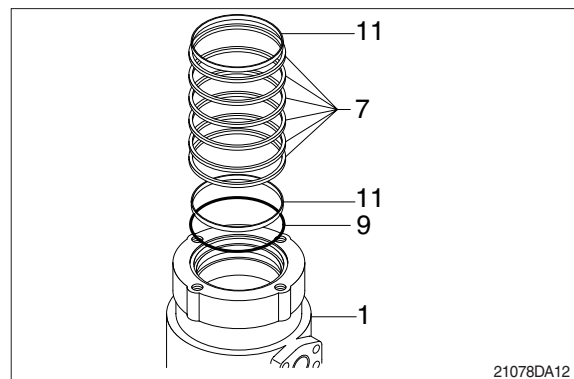

3) ASSEMBLY

- ※ Clean all parts.
- ※ As a general rule, replace oil seals and O-ring.
- ※ Coat the sliding surfaces of all parts with engine oil or grease before installing.

(1) Fix seven slipper seal (7) and O-ring (9), two wear ring (11) to hub (1).

(2) Fit O-ring (8) to shaft (2).

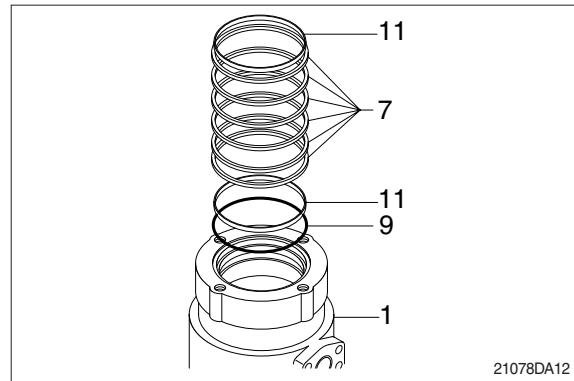

(3) Set shaft (2) on block, tap hub (1) with a plastic hammer to install.

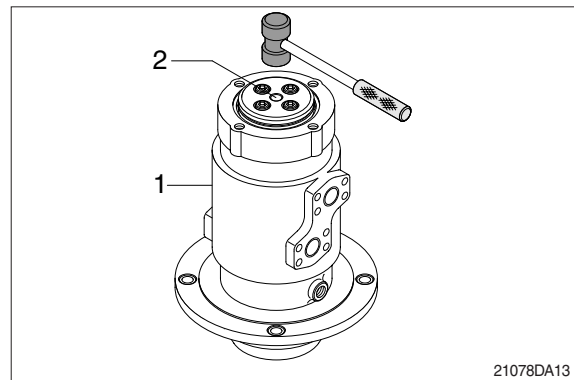

(4) Fit shim (5), spacer (4) and retainer ring (12) to shaft (2).

(5) Fit O-ring (10) to hub (1).

(6) Fit shim (6) to shaft (2).

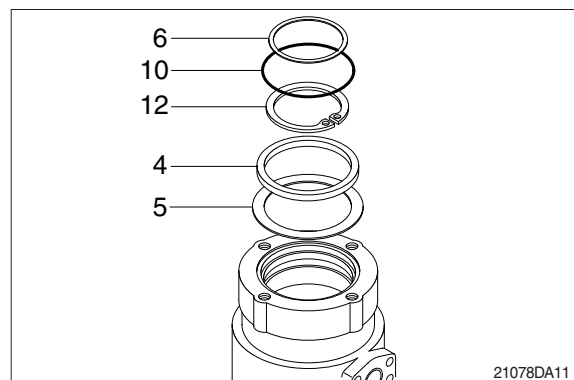

- (7) Install cover (3) to body (1) and tighten bolts (14).
- Torque : 10~12.5 kgf · m
(72.3~90.4 lbf · ft)

