

# SECTION 1 GENERAL



Group 1 Safety Hints .....	1-1
Group 2 Specifications .....	1-10

# SECTION 1 GENERAL

## GROUP 1 SAFETY

### FOLLOW SAFE PROCEDURE

Unsafe work practices are dangerous. Understand service procedure before doing work; Do not attempt shortcuts.

### WEAR PROTECTIVE CLOTHING

Wear close fitting clothing and safety equipment appropriate to the job.

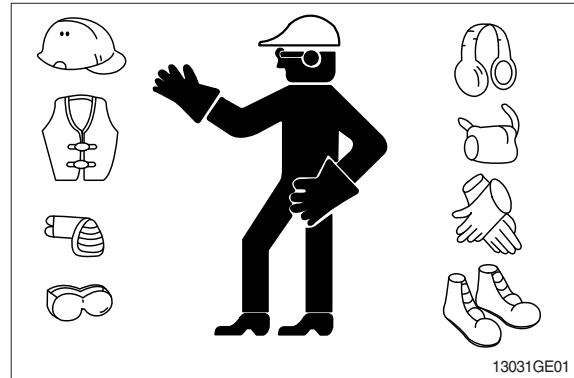

### WARN OTHERS OF SERVICE WORK

Unexpected machine movement can cause serious injury.

Before performing any work on the excavator, attach a 「Do Not Operate」 tag on the right side control lever.

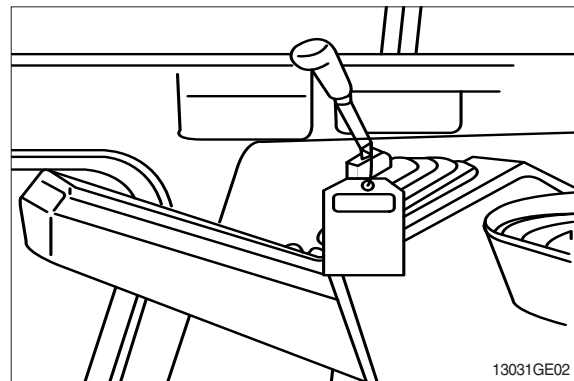

### USE HANDHOLDS AND STEPS

Falling is one of the major causes of personal injury.

When you get on and off the machine, always maintain a three point contact with the steps and handrails and face the machine. Do not use any controls as handholds.

Never jump on or off the machine. Never mount or dismount a moving machine.

Be careful of slippery conditions on platforms, steps, and handrails when leaving the machine.

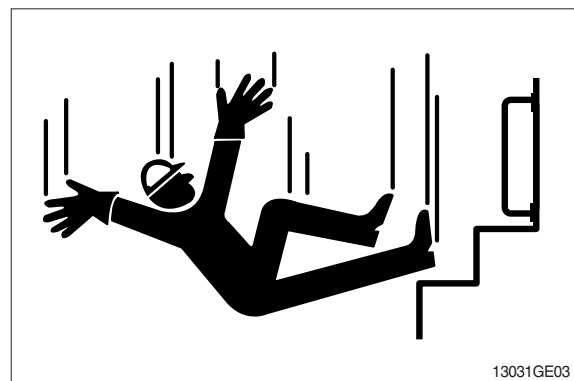

## PREPARE FOR EMERGENCIES

Be prepared if a fire starts.

Keep a first aid kit and fire extinguisher handy.

Keep emergency numbers for doctors, ambulance service, hospital, and fire department near your telephone.

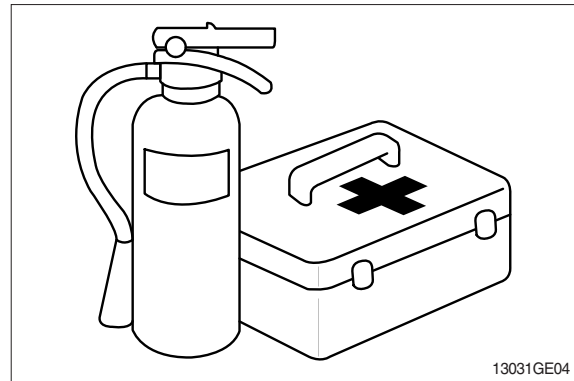

## PROTECT AGAINST FLYING DEBRIS

Guard against injury from flying pieces of metal or debris; Wear goggles or safety glasses.

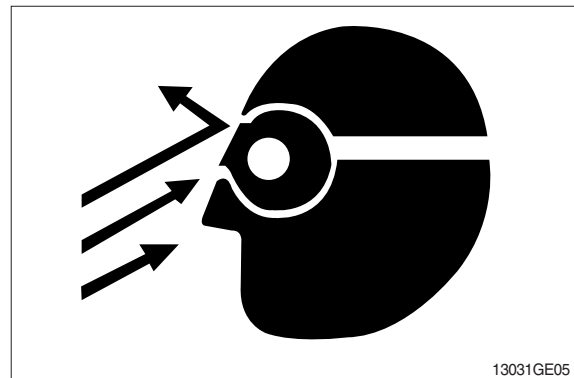

## PROTECT AGAINST NOISE

Prolonged exposure to loud noise can cause impairment or loss of hearing.

Wear a suitable hearing protective device such as earmuffs or earplugs to protect against objectionable or uncomfortable loud noises.

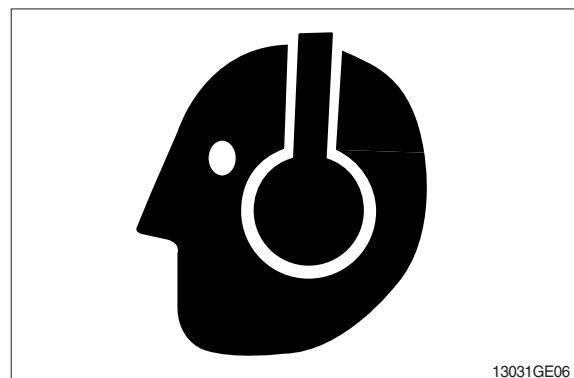

## AVOID POWER LINES

Serious injury or death can result from contact with electric lines.

Never move any part of the machine or load closer to electric line than 3m(10ft) plus twice the line insulator length.

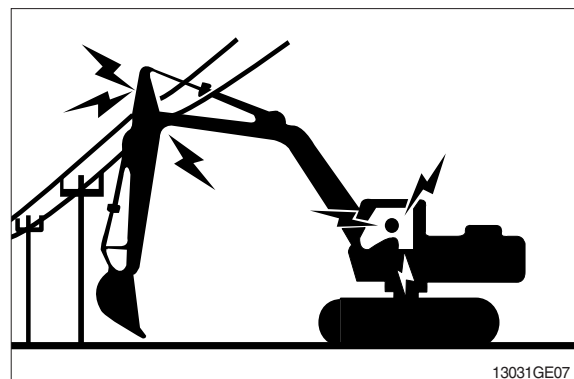

## KEEP RIDERS OFF EXCAVATOR

Only allow the operator on the excavator. Keep riders off.

Riders on excavator are subject to injury such as being struck by foreign objects and being thrown off the excavator. Riders also obstruct the operator's view resulting in the excavator being operated in an unsafe manner.

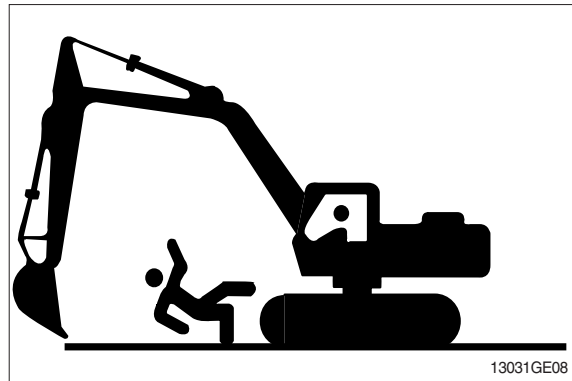

## MOVE AND OPERATE MACHINE SAFELY

Bystanders can be run over. Know the location of bystanders before moving, swinging, or operating the machine.

Always keep the travel alarm in working condition. It warns people when the excavator starts to move.

Use a signal person when moving, swinging, or operating the machine in congested areas. Coordinate hand signals before starting the excavator.

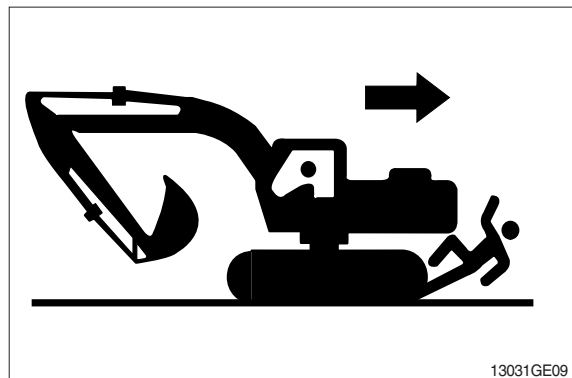

## OPERATE ONLY FROM OPERATOR'S SEAT

Avoid possible injury machine damage. Do not start engine by shorting across starter terminals.

NEVER start engine while standing on ground. Start engine only from operator's seat.



## PARK MACHINE SAFELY

Before working on the machine:

- Park machine on a level surface.
- Lower bucket to the ground.
- Turn auto idle switch off.
- Run engine at 1/2 speed without load for 2 minutes.
- Turn key switch to OFF to stop engine. Remove key from switch.
- Move pilot control shutoff lever to locked position.
- Allow engine to cool.

## SUPPORT MACHINE PROPERLY

Always lower the attachment or implement to the ground before you work on the machine. If you must work on a lifted machine or attachment, securely support the machine or attachment.

Do not support the machine on cinder blocks, hollow tiles, or props that may crumble under continuous load.

Do not work under a machine that is supported solely by a jack. Follow recommended procedures in this manual.

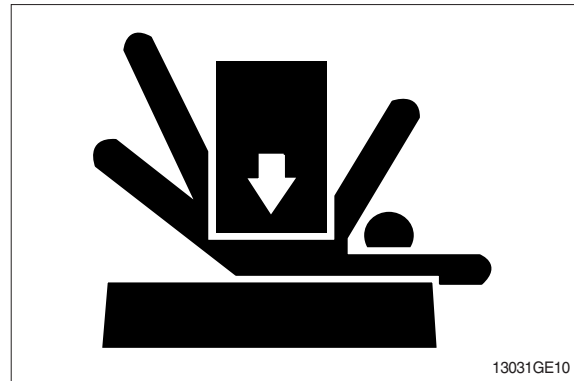

## SERVICE COOLING SYSTEM SAFELY

Explosive release of fluids from pressurized cooling system can cause serious burns.

Shut off engine. Only remove filler cap when cool enough to touch with bare hands.

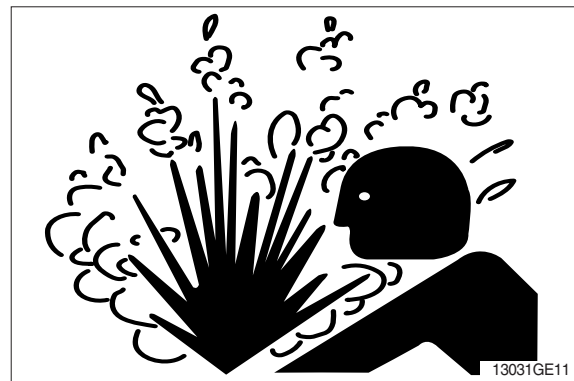

## HANDLE FLUIDS SAFELY-AVOID FIRES

Handle fuel with care; It is highly flammable. Do not refuel the machine while smoking or when near open flame or sparks. Always stop engine before refueling machine. Fill fuel tank outdoors.

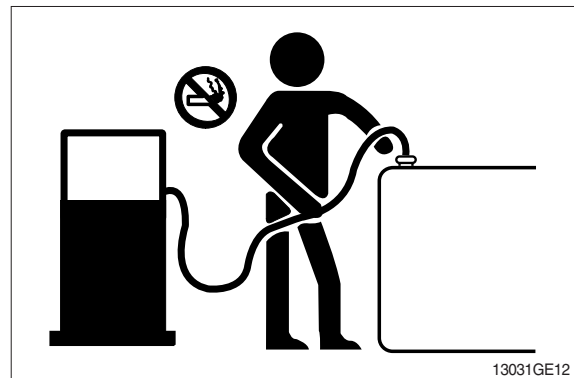

Store flammable fluids away from fire hazards. Do not incinerate or puncture pressurized containers.

Make sure machine is clean of trash, grease, and debris.

Do not store oily rags; They can ignite and burn spontaneously.

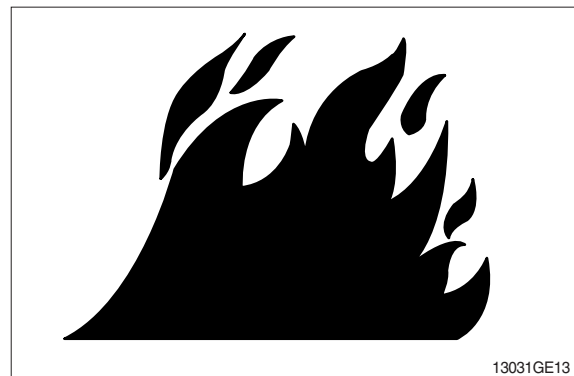

## BEWARE OF EXHAUST FUMES

Prevent asphyxiation. Engine exhaust fumes can cause sickness or death.

If you must operate in a building, be positive there is adequate ventilation. Either use an exhaust pipe extension to remove the exhaust fumes or open doors and windows to bring enough outside air into the area.

## REMOVE PAINT BEFORE WELDING OR HEATING

Avoid potentially toxic fumes and dust.

Hazardous fumes can be generated when paint is heated by welding, soldering, or using a torch.

Do all work outside or in a well ventilated area. Dispose of paint and solvent properly.

Remove paint before welding or heating:

- If you sand or grind paint, avoid breathing the dust.  
Wear an approved respirator.
- If you use solvent or paint stripper, remove stripper with soap and water before welding. Remove solvent or paint stripper containers and other flammable material from area. Allow fumes to disperse at least 15 minutes before welding or heating.

## ILLUMINATE WORK AREA SAFELY

Illuminate your work area adequately but safely. Use a portable safety light for working inside or under the machine. Make sure the bulb is enclosed by a wire cage. The hot filament of an accidentally broken bulb can ignite spilled fuel or oil.

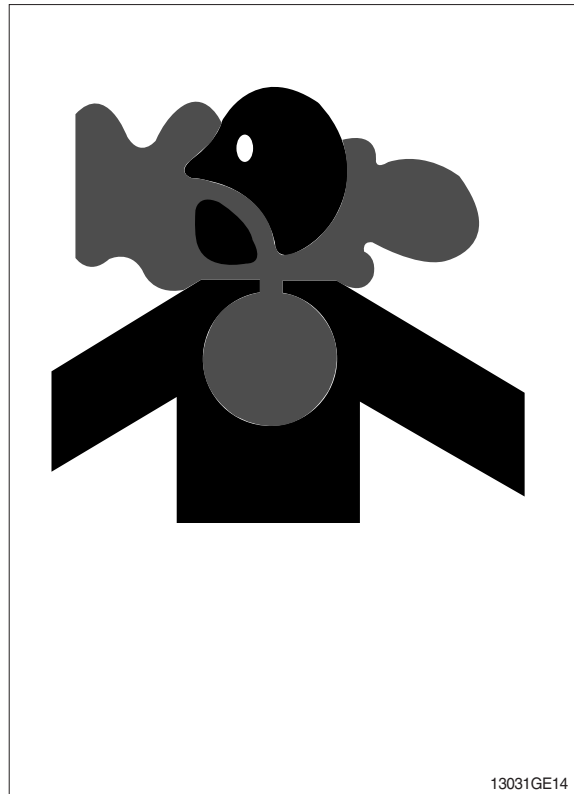

## SERVICE MACHINE SAFELY

Tie long hair behind your head. Do not wear a necktie, scarf, loose clothing or necklace when you work near machine tools or moving parts. If these items were to get caught, severe injury could result.

Remove rings and other jewelry to prevent electrical shorts and entanglement in moving parts.

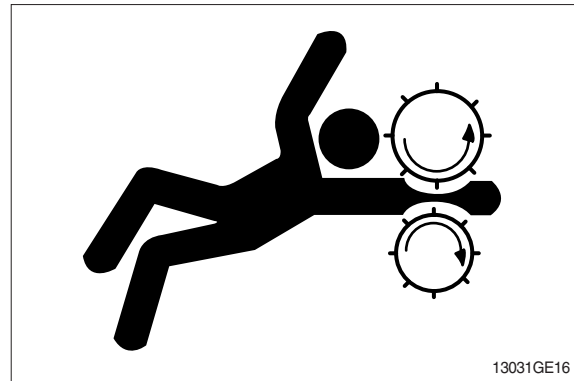

## STAY CLEAR OF MOVING PARTS

Entanglements in moving parts can cause serious injury.

To prevent accidents, use care when working around rotating parts.

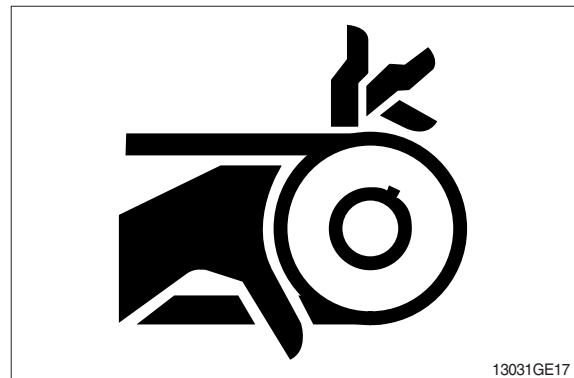

## AVOID HIGH PRESSURE FLUIDS

Escaping fluid under pressure can penetrate the skin causing serious injury.

Avoid the hazard by relieving pressure before disconnecting hydraulic or other lines. Tighten all connections before applying pressure.

Search for leaks with a piece of cardboard. Protect hands and body from high pressure fluids.

If an accident occurs, see a doctor immediately. Any fluid injected into the skin must be surgically removed within a few hours or gangrene may result.

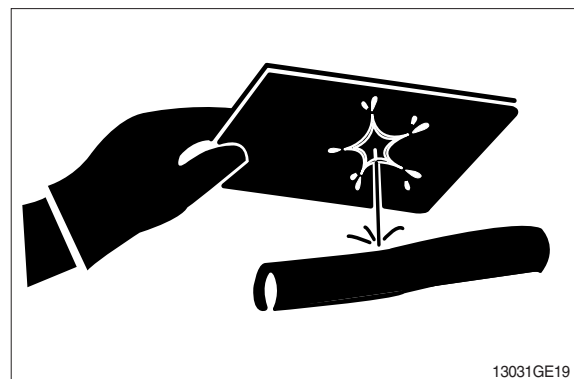

## **AVOID HEATING NEAR PRESSURIZED FLUID LINES**

Flammable spray can be generated by heating near pressurized fluid lines, resulting in severe burns to yourself and bystanders. Do not heat by welding, soldering, or using a torch near pressurized fluid lines or other flammable materials.

Pressurized lines can be accidentally cut when heat goes beyond the immediate flame area. Install fire resisting guards to protect hoses or other materials.



## **PREVENT BATTERY EXPLOSIONS**

Keep sparks, lighted matches, and flame away from the top of battery. Battery gas can explode.

Never check battery charge by placing a metal object across the posts. Use a volt-meter or hydrometer.

Do not charge a frozen battery; It may explode. Warm battery to 16°C (60°F).





## PREVENT ACID BURNS

Sulfuric acid in battery electrolyte is poisonous. It is strong enough to burn skin, eat holes in clothing, and cause blindness if splashed into eyes.

Avoid the hazard by:

1. Filling batteries in a well-ventilated area.
2. Wearing eye protection and rubber gloves.
3. Avoiding breathing fumes when electrolyte is added.
4. Avoiding spilling or dripping electrolyte.
5. Use proper jump start procedure.

If you spill acid on yourself:

1. Flush your skin with water.
2. Apply baking soda or lime to help neutralize the acid.
3. Flush your eyes with water for 10-15 minutes. Get medical attention immediately.

If acid is swallowed:

1. Drink large amounts of water or milk.
2. Then drink milk of magnesia, beaten eggs, or vegetable oil.
3. Get medical attention immediately.

## USE TOOLS PROPERLY

Use tools appropriate to the work. Makeshift tools, parts, and procedures can create safety hazards.

Use power tools only to loosen threaded tools and fasteners.

For loosening and tightening hardware, use the correct size tools. **DO NOT** use U.S. measurement tools on metric fasteners. Avoid bodily injury caused by slipping wrenches.

Use only recommended replacement parts. (See Parts catalogue.)

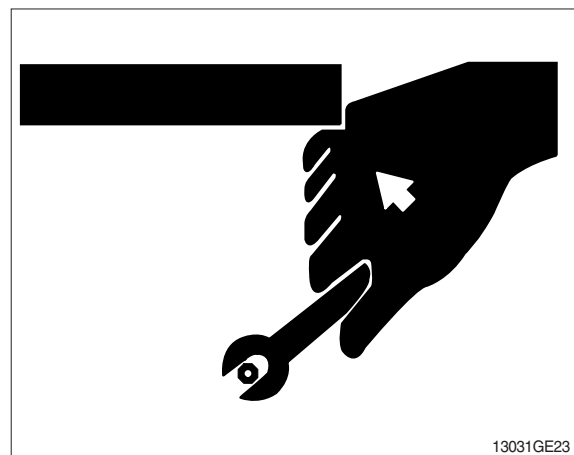
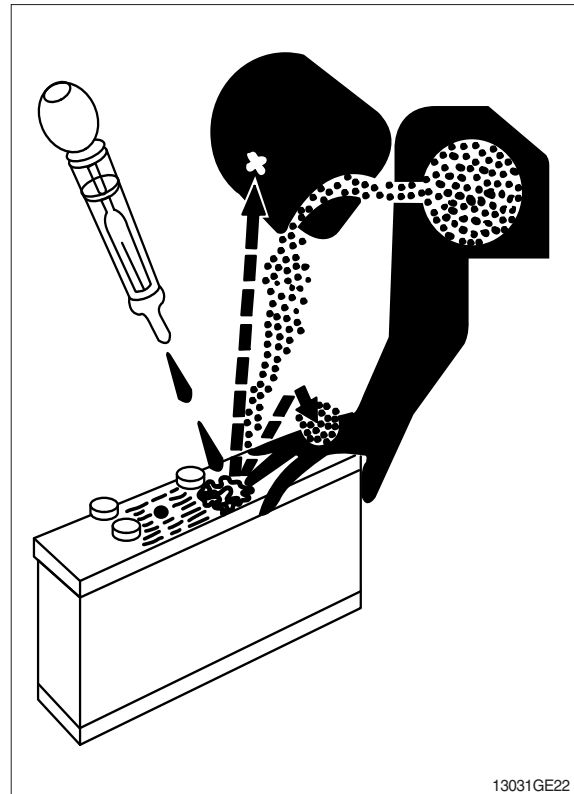

## DISPOSE OF FLUIDS PROPERLY

Improperly disposing of fluids can harm the environment and ecology. Before draining any fluids, find out the proper way to dispose of waste from your local environmental agency.

Use proper containers when draining fluids. Do not use food or beverage containers that may mislead someone into drinking from them.

DO NOT pour oil into the ground, down a drain, or into a stream, pond, or lake. Observe relevant environmental protection regulations when disposing of oil, fuel, coolant, brake fluid, filters, batteries, and other harmful waste.

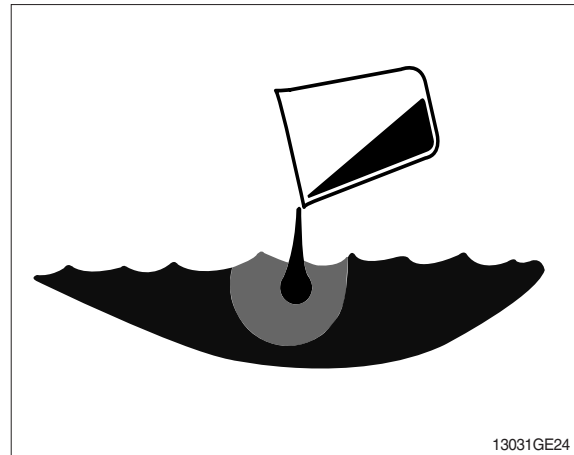

## REPLACE SAFETY SIGNS

Replace missing or damaged safety signs. See the machine operator's manual for correct safety sign placement.

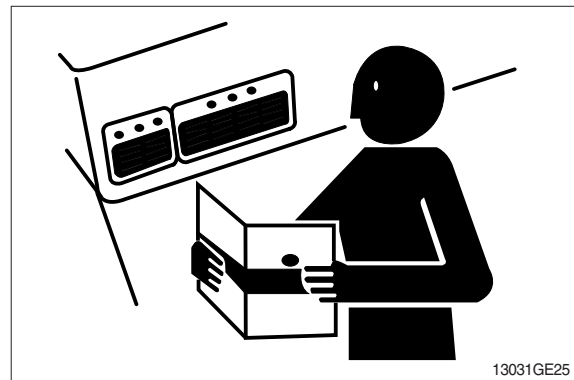

## LIVE WITH SAFETY

Before returning machine to customer, make sure machine is functioning properly, especially the safety systems. Install all guards and shields.

# GROUP 2 SPECIFICATIONS

## 1. MAJOR COMPONENT

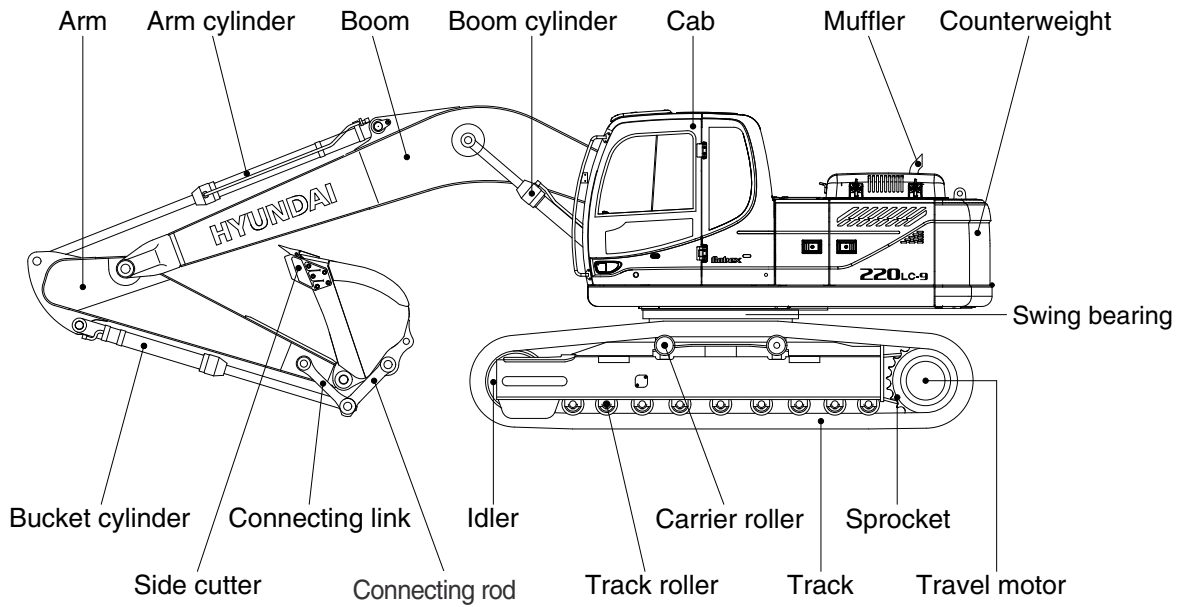
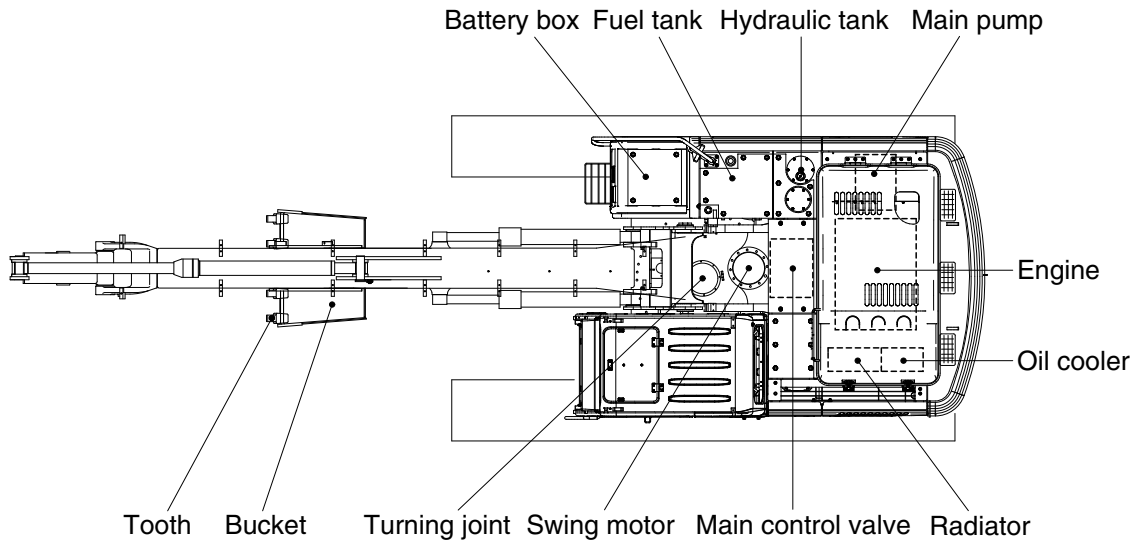

RD22092SP01

## 2. SPECIFICATIONS

### 1) ROBEX 220LC-9

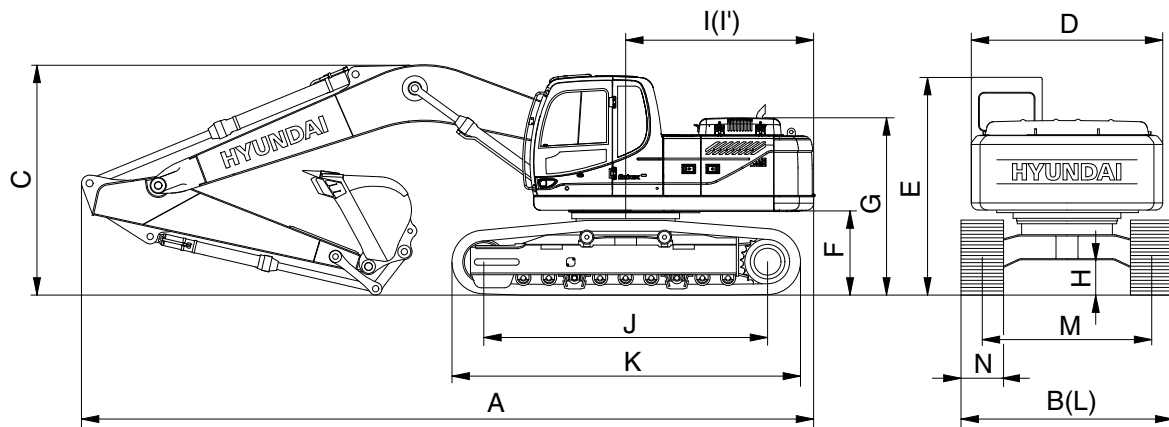

21092SP02

Description		Unit	Specification
Operating weight		kg (lb)	21900(48280)
Bucket capacity (SAE heaped), standard		m <sup>3</sup> (yd <sup>3</sup> )	1.05(1.37)
Overall length	A	mm (ft-in)	9570(31' 5")
Overall width, with 600mm shoe	B		2990( 9' 10")
Overall height	C		3110( 10' 2")
Superstructure width	D		2740( 9' 0")
Overall height of cab	E		2920( 9' 7")
Ground clearance of counterweight	F		1060( 3' 6")
Engine cover height	G		2320( 7' 7")
Minimum ground clearance	H		480( 1' 7")
Rear-end distance	I		2770( 9' 1")
Rear-end swing radius	I'		2840( 9' 4")
Distance between tumblers	J		3650(12' 0")
Undercarriage length	K		4440(14' 7")
Undercarriage width	L		2990( 9' 10")
Track gauge	M		2390( 7' 10")
Track shoe width, standard	N		600(24")
Travel speed (low/high)		km/hr (mph)	3.8/5.5(2.4/3.4)
Swing speed		rpm	11.1
Gradeability		Degree (%)	35(70)
Ground pressure (600 mm shoe)		kgf/cm <sup>2</sup> (psi)	0.45(6.40)

## 2) R220LC-9 LONG REACH

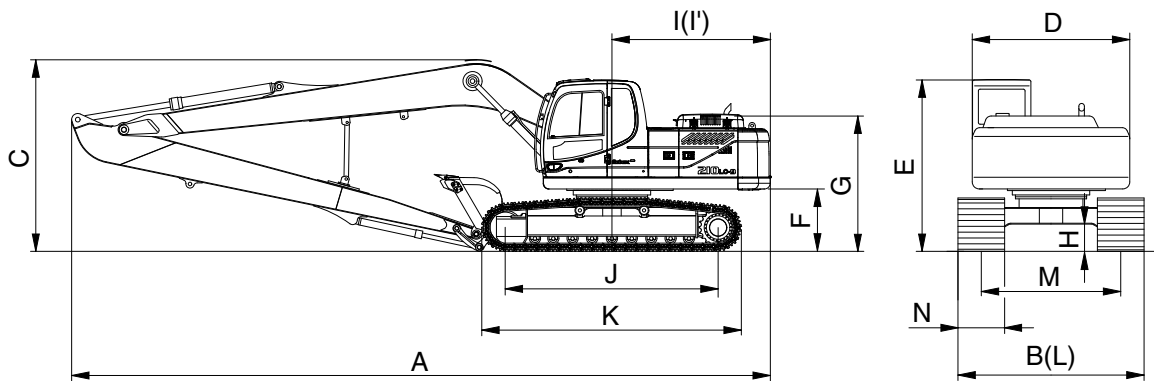

21092SP06

Description		Unit	Specification
Operating weight		kg (lb)	24605(54240)
Bucket capacity (SAE heaped), standard		m <sup>3</sup> (yd <sup>3</sup> )	0.52(0.68)
Overall length	A	mm (ft-in)	12030(39' 6")
Overall width, with 800mm shoe	B		3190(10' 6")
Overall height	C		3280(10' 9")
Superstructure width	D		2740( 9' 0")
Overall height of cab	E		2920( 9' 7")
Ground clearance of counterweight	F		1060( 3' 6")
Engine cover height	G		2320( 7' 7")
Minimum ground clearance	H		480( 1' 7")
Rear-end distance	I		2770( 9' 1")
Rear-end swing radius	I'		2840( 9' 4")
Distance between tumblers	J		3650(12' 0")
Undercarriage length	K		4440(14' 7")
Undercarriage width	L		3190(10' 6")
Track gauge	M		2390( 7' 10")
Track shoe width, standard	N		800(31' 5")
Travel speed (low/high)			km/hr (mph)
Swing speed		rpm	11.1
Gradeability		Degree (%)	35(70)
Ground pressure (800 mm shoe)		kgf/cm <sup>2</sup> (psi)	0.39(5.55)

### 3. WORKING RANGE

#### 1) R220LC-9 [5.68 m (18' 8") BOOM]

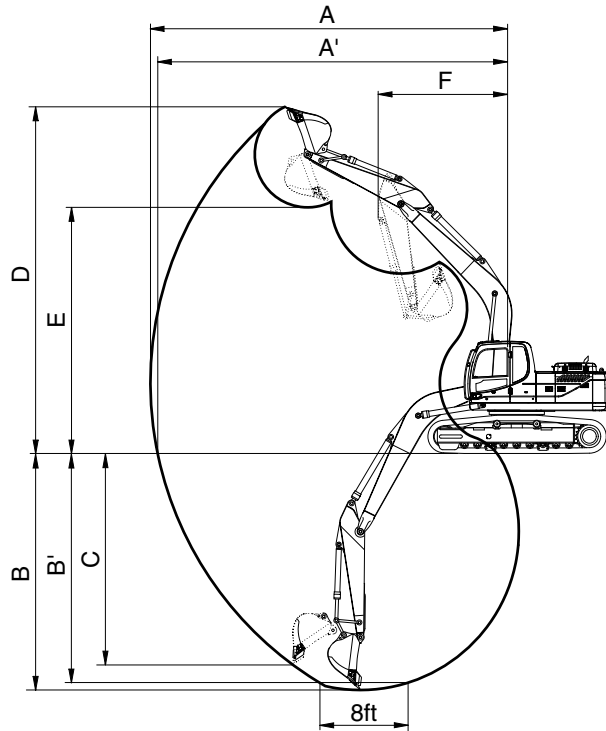

21092SP03

Description		2.0 m (6' 7") Arm	*2.40 m (7' 10") Arm	2.92 m (9' 7") Arm	3.90 m (12' 10") Arm
Max digging reach	A	9140 mm (30' 0")	9500 mm (31' 2")	9940 mm (32' 7")	10910 mm (35' 10")
Max digging reach on ground	A'	8960 mm (29' 5")	9330 mm (30' 7")	9780 mm (32' 1")	10770 mm (35' 4")
Max digging depth	B	5820 mm (19' 1")	6220 mm (20' 5")	6740 mm (22' 1")	7720 mm (25' 4")
Max digging depth (8 ft level)	B'	5580 mm (18' 4")	6010 mm (19' 9")	6550 mm (21' 6")	7580 mm (24' 10")
Max vertical wall digging depth	C	5280 mm (17' 4")	5720 mm (18' 9")	6120 mm (20' 1")	7240 mm (23' 9")
Max digging height	D	9140 mm (30' 0")	9340 mm (30' 8")	9470 mm (31' 1")	10110 mm (33' 2")
Max dumping height	E	6330 mm (20' 9")	6520 mm (21' 5")	6670 mm (21' 11")	7290 mm (23' 11")
Min swing radius	F	3750 mm (12' 4")	3740 mm (12' 3")	3640 mm (11' 11")	3650 mm (12' 0")
Bucket digging force	SAE	133.4 [144.8] kN	133.4 [144.8] kN	133.4 [144.8] kN	133.4 [144.8] kN
		13600 [14770] kgf	13600 [14770] kgf	13600 [14770] kgf	13600 [14770] kgf
		29980 [32550] lbf	29980 [32550] lbf	29980 [32550] lbf	29980 [32550] lbf
	ISO	152.0 [165.0] kN	152.0 [165.0] kN	152.0 [165.0] kN	152.0 [165.0] kN
		15500 [16830] kgf	15500 [16830] kgf	15500 [16830] kgf	15500 [16830] kgf
		34170 [37100] lbf	34170 [37100] lbf	34170 [37100] lbf	34170 [37100] lbf
Arm digging force	SAE	144.2 [156.5] kN	119.6 [129.9] kN	102.0 [110.7] kN	84.3 [91.6] kN
		14700 [15960] kgf	12200 [13250] kgf	10400 [11290] kgf	8600 [9340] kgf
		32410 [35190] lbf	26900 [29210] lbf	22930 [24900] lbf	18960 [20590] lbf
	ISO	151.0 [164.0] kN	125.5 [136.3] kN	106.9 [116.1] kN	87.3 [94.8] kN
		15400 [16720] kgf	12800 [13900] kgf	10900 [11830] kgf	8900 [9660] kgf
		33950 [36860] lbf	28220 [30640] lbf	24030 [26090] lbf	19620 [21300] lbf

[ ] : Power boost \* : Standard

2) R220LC-9 LONG REACH [8.2m (26' 11") BOOM]

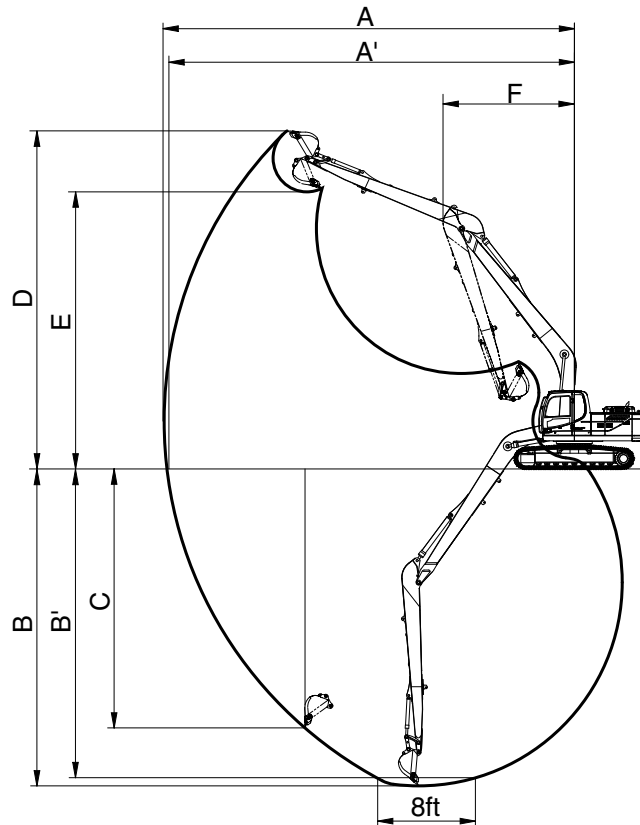

21092SP08

Description		6.3 m (20' 8") Arm	
Max digging reach	A	15220(50' 0")	
Max digging reach on ground	A'	15120(49' 7")	
Max digging depth	B	11760(38' 7")	
Max digging depth (8 ft level)	B'	11650(38' 3")	
Max vertical wall digging depth	C	9610(31' 6")	
Max digging height	D	12550(41' 2")	
Max dumping height	E	10280(33' 8")	
Min swing radius	F	4870(16' 0")	
Bucket digging force	SAE	72.6 kN	
		7400 kgf	
		16310 lbf	
	ISO	83.4 kN	
		8500 kgf	
		18740 lbf	
Arm crowd force	SAE	49.0 kN	
		5000 kgf	
		11020 lbf	
	ISO	50.0 kN	
		5100 kgf	
		11240 lbf	

## 4. WEIGHT

### 1) R220LC-9

Item	R220LC-9	
	kg	lb
Upperstructure assembly	8950	19730
Main frame weld assembly	1720	3790
Engine assembly	530	1170
Main pump assembly	120	265
Main control valve assembly	200	440
Swing motor assembly	190	420
Hydraulic oil tank assembly	240	530
Fuel tank assembly	195	430
Counterweight	3800	8380
Cab assembly	440	970
Lower chassis assembly	8700	19180
Track frame weld assembly	2720	6000
Swing bearing	260	570
Travel motor assembly	305	670
Turning joint	55	120
Track recoil spring	140	310
Idler	170	370
Carrier roller	20	45
Track roller	50	110
Track-chain assembly (600 mm standard triple grouser shoe)	1400	3090
Front attachment assembly (5.68 m boom, 2.92 m arm, 0.92 m <sup>3</sup> SAE heaped bucket)	4005	8830
5.68 m boom assembly	1530	3370
2.92 m arm assembly	670	1480
0.92 m <sup>3</sup> SAE heaped bucket	810	1790
Boom cylinder assembly	180	400
Arm cylinder assembly	290	640
Bucket cylinder assembly	175	390
Bucket control link assembly	170	370



## 2) R220LC-9 LONG REACH

Item	R220LC-9 LONG REACH	
	kg	lb
Upperstructure assembly	8950	19730
Main frame weld assembly	1720	3790
Engine assembly	530	1170
Main pump assembly	120	265
Main control valve assembly	200	440
Swing motor assembly	190	420
Hydraulic oil tank assembly	240	530
Fuel tank assembly	195	430
Counterweight	5300	11680
Cab assembly	440	970
Lower chassis assembly	8700	19180
Track frame weld assembly	2720	6000
Swing bearing	260	570
Travel motor assembly	305	670
Turning joint	55	120
Track recoil spring	140	310
Idler	170	370
Carrier roller	20	45
Track roller	50	110
Track-chain assembly (800 mm standard triple grouser shoe)	1660	3660
Front attachment assembly (8.2 m boom, 6.3 m arm, 0.52 m <sup>3</sup> SAE heaped bucket)	4595	10130
8.2 m boom assembly	2105	4640
6.3 m arm assembly	1100	2430
0.52 m <sup>3</sup> SAE heaped bucket	465	1030
Boom cylinder assembly	180	400
Arm cylinder assembly	270	600
Bucket cylinder assembly	130	290
Bucket control rod assembly	170	370











## 5. LIFTING CAPACITIES

### 1) ROBEX 220LC-9

(1) 5.68m(18' 8") boom, 2.00m(6' 7") arm equipped with 1.05m<sup>3</sup>(SAE heaped) bucket, 600mm (24") triple grouser shoe and 3800kg counterweight.













•  : Rating over-front

•  : Rating over-side or 360 degree













Load point height		Load radius								At max. reach		
		3.0 m (10 ft)		4.5 m (15 ft)		6.0 m (20 ft)		7.5 m (25 ft)		Capacity		Reach
												m (ft)
7.5m (25ft)	kg lb									*3660 *8070	*3660 *8070	6.64 (21.8)
6.0m (20ft)	kg lb					*4060 *8950	*4060 *8950			*3700 *8160	2980 6570	7.78 (25.5)
4.5m (15ft)	kg lb			*5270 *11620	*5270 *11620	*4450 *9810	*4450 *9810			*3810 *8400	2480 5470	8.43 (27.7)
3.0m (10ft)	kg lb			*6870 *15150	6750 14880	*5140 *11330	4300 9480	*4410 *9720	2940 6480	*3960 *8730	2250 4960	8.74 (28.7)
1.5m (5ft)	kg lb			*8270 *18230	6220 13710	*5860 *12920	4040 8910	*4730 *10430	2820 6220	3920 8640	2200 4850	8.73 (28.6)
Ground Line	kg lb			*8910 *19640	5990 13210	*6330 *13960	3870 8530	4900 10800	2750 6060	4130 9110	2320 5110	8.42 (27.6)
-1.5m (-5ft)	kg lb	*12900 *28440	12070 26610	*8850 *19510	5960 13140	*6410 *14130	3820 8420			*4450 *9810	2690 5930	7.76 (25.5)
-3.0m (-10ft)	kg lb	*11510 *25380	*11510 *25380	*8100 *17860	6070 13380	*5810 *12810	3910 8620			*4410 *9720	3580 7890	6.61 (21.7)
-4.5m (-15ft)	kg lb	*8660 *19090	*8660 *19090									

- Note
1. Lifting capacity are based on SAE J1097 and ISO 10567.
  2. Lifting capacity of the ROBEX series does not exceed 75% of tipping load with the machine on firm, level ground or 87% of full hydraulic capacity.
  3. The load point is a hook located on the back of the bucket.
  4. \*indicates load limited by hydraulic capacity.















(2) 5.68m(18' 8") boom, 2.40m(7' 10") arm equipped with 1.05m<sup>3</sup>(SAE heaped) bucket, 600mm (24") triple grouser shoe and 3800kg counterweight.

Load point height		Load radius										At max. reach				
		1.5 m (5 ft)		3.0 m (10 ft)		4.5 m (15 ft)		6.0 m (20ft)		7.5 m (25ft)		Capacity		Reach		
														m (ft)		
7.5m (25ft)	kg lb													*3360 *7410	*3360 *7410	7.15 (23.5)
6.0m (20ft)	kg lb							*3660 *8070	*3660 *8070					*3420 *7540	2700 5950	8.20 (26.9)
4.5m (15ft)	kg lb							*4100 *9040	*4100 *9040	*3840 *8470	3060 6750			*3530 *7780	2270 5000	8.82 (28.9)
3.0m (10ft)	kg lb					*6330 *13960	*6330 *13960	*4820 *10630	4320 9520	*4150 *9150	2940 6480			3680 8110	2070 4560	9.11 (29.9)
1.5m (5ft)	kg lb					*7850 *17310	6270 13820	*5590 *12320	4040 8910	*4530 *9990	2810 6190			3640 8020	2020 4450	9.10 (29.9)
Ground Line	kg lb			*8380 *18470	*8380 *18470	*8710 *19200	5960 13140	*6160 *13580	3840 8470	*4820 *10630	2710 5970			3810 8400	2110 4650	8.81 (28.9)
-1.5m (-5ft)	kg lb	*9290 *20480	*9290 *20480	*12830 *28290	11840 26100	*8860 *19530	5870 12940	*6360 *14020	3760 8290					*4210 *9280	2410 5310	8.18 (26.8)
-3.0m (-10ft)	kg lb	*13420 *29590	*13420 *29590	*12170 *26830	12070 26610	*8330 *18360	5950 13120	*6010 *13250	3810 8400					*4270 *9410	3110 6860	7.12 (23.4)
-4.5m (-15ft)	kg lb			*9730 *21450	*9730 *21450	*6750 *14880	6210 13690									

(3) 5.68m(18' 8") boom, 2.92m(9' 7") arm equipped with 1.05m<sup>3</sup>(SAE heaped) bucket, 600mm (24") triple grouser shoe and 3800kg counterweight.



Load point height		Load radius										At max. reach				
		1.5 m (5 ft)		3.0 m (10 ft)		4.5 m (15 ft)		6.0 m (20 ft)		7.5 m (25 ft)		Capacity		Reach		
														m (ft)		
7.5m (25ft)	kg lb													*3030 *6680	*3030 *6680	7.72 (25.3)
6.0m (20ft)	kg lb													*3120 *6880	2450 5400	8.69 (28.5)
4.5m (15ft)	kg lb							*3670 *8090	*3670 *8090	*3490 *7690	3130 6900			*3240 *7140	2080 4590	9.27 (30.4)
3.0m (10ft)	kg lb			*9050 *19950	*9050 *19950	*5670 *12500	*5670 *12500	*4440 *9790	4410 9720	*3860 *8510	2990 6590			*3390 *7470	1900 4190	9.55 (31.3)
1.5m (5ft)	kg lb			*8750 *19290	*8750 *19290	*7330 *16160	6410 14130	*5280 *11640	4100 9040	*4300 *9480	2830 6240			3360 7410	1850 4080	9.54 (31.3)
Ground Line	kg lb			*9390 *20700	*9390 *20700	*8440 *18610	6010 13250	*5960 *13140	3860 8510	*4680 *10320	2700 5950			3490 7690	1920 4230	9.26 (30.4)
-1.5m (-5ft)	kg lb	*8630 *19030	*8630 *19030	*12250 *27010	11720 25840	*8840 *19490	5850 12900	*6300 *13890	3740 8250	4790 10560	2640 5820			3890 8580	2150 4740	8.67 (28.4)
-3.0m (-10ft)	kg lb	*11780 *25970	*11780 *25970	*12900 *28440	11880 26190	*8580 *18920	5870 12940	*6180 *13620	3730 8220					*4130 *9110	2680 5910	7.69 (25.2)
-4.5m (-15ft)	kg lb			*10920 24070	*10920 *24070	*7450 *16420	6050 13340							*4050 *8930	*4050 *8930	6.09 (20.0)











(4) 5.68m(18' 8") boom, 3.90m(12' 10") arm equipped with 1.05m<sup>3</sup>(SAE heaped) bucket, 600mm (24") triple grouser shoe and 3800kg counterweight.

Load point height		Load radius												At max. reach			
		1.5 m (5 ft)		3.0 m (10 ft)		4.5 m (15 ft)		6.0 m (20 ft)		7.5 m (25 ft)		9.0 m (30 ft)		Capacity		Reach	
																m (ft)	
9.0m (30ft)	kg lb														*2490 *5490	*2490 *5490	7.66 (25.1)
7.5m (25ft)	kg lb									*1790 *3950	*1790 *3950			*2540 *5600	2390 5270	8.94 (29.3)	
6.0m (20ft)	kg lb									*2580 *5690	*2580 *5690			*2620 *5780	1930 4250	9.77 (32.1)	
4.5m (15ft)	kg lb									*2820 *6220	*2820 *6220	*1840 *4060	*1840 *4060	*2730 *6020	1670 3680	10.28 (33.7)	
3.0m (10ft)	kg lb							*3610 *7960	*3610 *7960	*3250 *7170	3050 6720	*2660 *5860	2110 4650	2860 6310	1530 3370	10.52 (34.5)	
1.5m (5ft)	kg lb			*10320 *22750	*10320 *22750	*6130 *13510	*6130 *13510	*4550 *10030	4190 9240	*3770 *8310	2850 6280	*3180 *7010	2010 4430	2810 6190	1480 3260	10.52 (34.5)	
Ground Line	kg lb	*5040 *11110	*5040 *11110	*10080 *22220	*10080 *22220	*7620 *16800	6080 13400	*5390 *11880	3870 8530	*4260 *9390	2680 *7170	*3250 4230	1920 6370	2890 3350	1520 (33.7)	10.27	
-1.5m (-5ft)	kg lb	*7150 *15760	*7150 *15760	*11070 *24410	*11070 *24410	*8460 *18650	5760 12700	*5970 *13160	3670 8090	*4610 *10160	2550 5620	*2160 *4760	1870 4120	3140 6920	1670 3680	9.75 (32.0)	
-3.0m (-10ft)	kg lb	*9500 *20940	*9500 *20940	*13560 *29890	11450 25240	*8650 *19070	5670 12500	*6170 *13600	3590 7910	4660 10270	2510 5530			*3550 *7830	1990 4390	8.91 (29.2)	
-4.5m (-15ft)	kg lb	*12290 *27090	*12290 *27090	*12370 *27270	11680 25750	*8140 *17950	5740 12650	*5820 *12830	3630 8000					*3670 *8090	2690 5930	7.62 (25.0)	
-6.0m (-20ft)	kg lb			*9790 *21580	*9790 *21580	*6520 *14370	6020 13270										

## 2) R220LC-9 LONG REACH

(1) 8.2m(26' 11") boom, 6.3m(20' 8") arm equipped with 0.52m<sup>3</sup>(SAE heaped) bucket, 800mm (32") triple grouser shoe and 5300kg counterweight.

-  : Rating over-front
-  : Rating over-side or 360 degree

Load point height		Load radius								At max. reach		
		3.0 m (10 ft)		6.0 m (20 ft)		9.0 m (30 ft)		12.0 m (40 ft)		Capacity		Reach
												m (ft)
9.0 m (30 ft)	kg							*830	*830	*1330	*1330	13.11
	lb							*1830	*1830	*2930	*2930	(43.0)
6.0 m (20 ft)	kg							*1430	*1430	*1410	1160	14.37
	lb							*3150	*3150	*3110	2560	(47.1)
3.0 m (10 ft)	kg					*1990	*1990	*1670	1630	*1520	980	14.89
	lb					*4390	*4390	*3680	3590	*3350	2160	(48.9)
Ground Line	kg	*4560	*4560	*4330	*4330	*2650	2430	*1980	1440	*1670	930	14.75
	lb	*10050	*10050	*9550	*9550	*5840	5360	*4370	3170	*3680	2050	(48.4)
-3.0 m (-10 ft)	kg	*5710	*5710	*5250	3920	*3150	2140	*2220	1310	*1860	1020	13.92
	lb	*12590	*12590	*11570	8640	*6940	4720	*4890	2890	*4100	2250	(45.7)
-6.0 m (-20 ft)	kg	*7790	*7790	*5370	3840	*3280	2060			*2090	1330	12.25
	lb	*17170	*17170	*11840	8470	*7230	4540			*4610	2930	(40.2)
-9.0 m (-30 ft)	kg	*8780	*8780	*4510	4110	*2620	2260					
	lb	*19360	*19360	*9940	9060	*5780	4980					

- Note
1. Lifting capacity are based on SAE J1097 and ISO 10567.
  2. Lifting capacity of the ROBEX series does not exceed 75% of tipping load with the machine on firm, level ground or 87% of full hydraulic capacity.
  3. The load point is a hook located on the back of the bucket.
  4. \*indicates load limited by hydraulic capacity.

## 6. BUCKET SELECTION GUIDE

### 1) GENERAL BUCKET

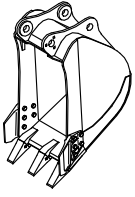
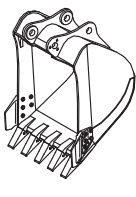
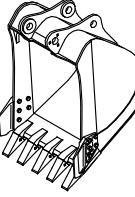
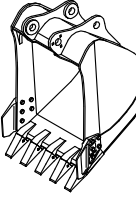
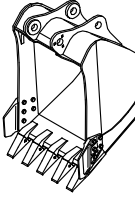
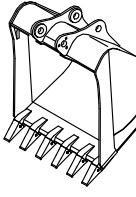
					
0.51 m <sup>3</sup> SAE heaped bucket	0.80 m <sup>3</sup> SAE heaped bucket	0.92 m <sup>3</sup> SAE heaped bucket	※ 1.05 m <sup>3</sup> SAE heaped bucket	1.20 m <sup>3</sup> SAE heaped bucket	1.34 m <sup>3</sup> SAE heaped bucket

Capacity		Width		Weight	Recommendation				
					5.68 m (18' 8") boom				8.2 m (26' 11") boom
SAE heaped	CECE heaped	Without side cutter	With side cutter		2.0 m arm (6' 7")	2.4 m arm (7' 10")	2.92 m arm (9' 7")	3.90 m arm (12' 10")	6.3 m arm (20' 8")
0.51 m <sup>3</sup> (0.67 yd <sup>3</sup> )	0.45 m <sup>3</sup> (0.59 yd <sup>3</sup> )	700 mm (27.6")	820 mm (32.3")	570 kg (1260 lb)					
0.80 m <sup>3</sup> (1.05 yd <sup>3</sup> )	0.70 m <sup>3</sup> (0.92 yd <sup>3</sup> )	1000 mm (39.4")	1120 mm (44.1")	770 kg (1700 lb)					
0.92 m <sup>3</sup> (1.20 yd <sup>3</sup> )	0.80 m <sup>3</sup> (1.05 yd <sup>3</sup> )	1150 mm (45.3")	1270 mm (50.0")	770 kg (1700 lb)					
※ 1.05 m <sup>3</sup> (1.37 yd <sup>3</sup> )	0.90 m <sup>3</sup> (1.18 yd <sup>3</sup> )	1250 mm (49.2")	1370 mm (53.9")	810 kg (1790 lb)					
1.20 m <sup>3</sup> (1.57 yd <sup>3</sup> )	1.00 m <sup>3</sup> (1.31 yd <sup>3</sup> )	1400 mm (55.1")	1520 mm (59.8")	850 kg (1870 lb)					
1.34 m <sup>3</sup> (1.75 yd <sup>3</sup> )	1.15 m <sup>3</sup> (1.50 yd <sup>3</sup> )	1550 mm (61.0")	1670 mm (65.7")	920 kg (2030 lb)					
★ 0.52 m <sup>3</sup> (0.68 yd <sup>3</sup> )	0.45 m <sup>3</sup> (0.59 yd <sup>3</sup> )	935 mm (36.8")	1035 mm (40.7")	460 kg (1010 lb)					

※ : Standard bucket

★ : Long reach bucket

 Applicable for materials with density of 2000 kgf/m<sup>3</sup> (3370 lbf/yd<sup>3</sup>) or less

 Applicable for materials with density of 1600 kgf/m<sup>3</sup> (2700 lbf/yd<sup>3</sup>) or less

 Applicable for materials with density of 1100 kgf/m<sup>3</sup> (1850 lbf/yd<sup>3</sup>) or less

## 2) HEAVY DUTY, ROCK-HEAVY DUTY AND SLOPE FINISHING BUCKET

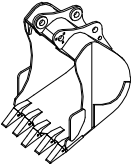
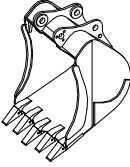
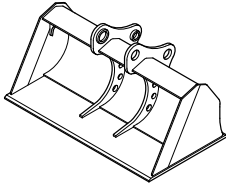
Heavy duty bucket	Rock-heavy duty bucket	Slope finishing bucket
		
◆ 0.74, 0.90, 1.05 m <sup>3</sup> SAE heaped bucket	◎ 0.87, 1.20 m <sup>3</sup> SAE heaped bucket	■ 0.75 m <sup>3</sup> SAE heaped bucket

Capacity		Width		Weight	Recommendation			
SAE heaped	CECE heaped	Without side cutter	With side cutter		5.68 m (18' 8") boom			
					2.0 m arm (6' 7")	2.4 m arm (7' 10")	2.92 m arm (9' 7")	3.90 m arm (12' 10")
◆0.74 m <sup>3</sup> (0.97 yd <sup>3</sup> )	0.65 m <sup>3</sup> (0.85 yd <sup>3</sup> )	985 mm (38.8")	-	770 kg (1700 lb)				
◆0.90 m <sup>3</sup> (1.18 yd <sup>3</sup> )	0.80 m <sup>3</sup> (1.05 yd <sup>3</sup> )	1095 mm (43.1")	-	810 kg (1790 lb)				
◆1.05 m <sup>3</sup> (1.37 yd <sup>3</sup> )	0.92 m <sup>3</sup> (1.20 yd <sup>3</sup> )	1290 mm (50.8")	-	890 kg (1960 lb)				
◎0.87 m <sup>3</sup> (1.14 yd <sup>3</sup> )	0.75 m <sup>3</sup> (0.98 yd <sup>3</sup> )	1140 mm (44.9")	-	900 kg (1980 lb)				
◎1.20 m <sup>3</sup> (1.57 yd <sup>3</sup> )	1.00 m <sup>3</sup> (1.31 yd <sup>3</sup> )	1410 mm (55.5")	-	1030 kg (2270 lb)				
■0.75 m <sup>3</sup> (0.98 yd <sup>3</sup> )	0.65 m <sup>3</sup> (0.85 yd <sup>3</sup> )	1790 mm (70.5")	-	880 kg (1940 lb)				

◆ : Heavy duty bucket    ◎ : Rock-heavy duty bucket    ■ : Slope finishing bucket

 Applicable for materials with density of 2000 kgf/m<sup>3</sup> (3370 lbf/yd<sup>3</sup>) or less

 Applicable for materials with density of 1600 kgf/m<sup>3</sup> (2700 lbf/yd<sup>3</sup>) or less

 Applicable for materials with density of 1100 kgf/m<sup>3</sup> (1850 lbf/yd<sup>3</sup>) or less

## 7. UNDERCARRIAGE

### 1) TRACKS

X-leg type center frame is integrally welded with reinforced box-section track frames. The design includes dry tracks, lubricated rollers, idlers, sprockets, hydraulic track adjusters with shock absorbing springs and assembled track-type tractor shoes with triple grousers.

### 2) TYPES OF SHOES

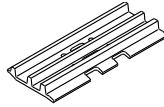
Model	Shapes		Triple grouser			
						
R220LC-9	Shoe width	mm (in)	600 (24)	700 (28)	800 (32)	900 (36)
	Operating weight	kg (lb)	21900 (48280)	22250 (49050)	22515 (49640)	22760 (50180)
	Ground pressure	kgf/cm <sup>2</sup> (psi)	0.45 (6.40)	0.40 (5.69)	0.36 (5.12)	0.32 (4.55)
	Overall width	mm (ft-in)	2990 (9' 10")	3090 (10' 2")	3190 (10' 6")	3290 (10' 10")
R220LC-9 LONG REACH	Shoe width	mm (in)	-	-	800 (32)	-
	Operating weight	kg (lb)	-	-	24605 (54240)	-
	Ground pressure	kgf/cm <sup>2</sup> (psi)	-	-	0.39 (5.55)	-
	Overall width	mm (ft-in)	-	-	3190 (10' 6")	-

### 3) NUMBER OF ROLLERS AND SHOES ON EACH SIDE

Item	Quantity
Carrier rollers	2 EA
Track rollers	9 EA
Track shoes	49 EA



#### 4) SELECTION OF TRACK SHOE

Suitable track shoes should be selected according to operating conditions.

##### Method of selecting shoes

Confirm the category from the list of applications in **table 2**, then use **table 1** to select the shoe. Wide shoes (categories B and C) have limitations on applications. Before using wide shoes, check the precautions, then investigate and study the operating conditions to confirm if these shoes are suitable.

Select the narrowest shoe possible to meet the required flotation and ground pressure. Application of wider shoes than recommendations will cause unexpected problem such as bending of shoes, crack of link, breakage of pin, loosening of shoe bolts and the other various problems.

※ **Table 1**

Track shoe	Specification	Category
600 mm triple grouser	Standard	A
700 mm triple grouser	Option	B
800 mm triple grouser	Option	C
800 mm triple grouser (long reach)	Standard	C
900 mm triple grouser	Option	C

※ **Table 2**

Category	Applications	Precautions
A	Rocky ground, river beds, normal soil	<ul style="list-style-type: none"> <li>Travel at low speed on rough ground with large obstacles such as boulders or fallen trees</li> </ul>
B	Normal soil, soft ground	<ul style="list-style-type: none"> <li>These shoes cannot be used on rough ground with large obstacles such as boulders or fallen trees</li> <li>Travel at high speed only on flat ground</li> <li>Travel slowly at low speed if it is impossible to avoid going over obstacles</li> </ul>
C	Extremely soft ground (swampy ground)	<ul style="list-style-type: none"> <li>Use the shoes only in the conditions that the machine sinks and it is impossible to use the shoes of category A or B</li> <li>These shoes cannot be used on rough ground with large obstacles such as boulders or fallen trees</li> <li>Travel at high speed only on flat ground</li> <li>Travel slowly at low speed if it is impossible to avoid going over obstacles</li> </ul>

## 8. SPECIFICATIONS FOR MAJOR COMPONENTS

### 1) ENGINE

Item	Specification
Model	Kirloskar 6BTAA
Type	4-cycle turbocharged diesel engine, low emission
Cooling method	Water cooling
Number of cylinders and arrangement	6 cylinders, in-line
Firing order	1-5-3-6-2-4
Combustion chamber type	Direct injection type
Cylinder bore × stroke	102 × 120 mm (4.02" × 4.72")
Piston displacement	5880 cc (359 cu in)
Compression ratio	17.3 : 1
Rated gross horse power (SAE J1995)	150 Hp at 1950 rpm (112 kW at 1950 rpm)
Maximum torque at 1500 rpm	62.6 kgf · m (453 lbf · ft)
Engine oil quantity	24 l (6.3 U.S. gal)
Dry weight	530 kg (1168 lb)
High idling speed	2180 ± 50 rpm
Low idling speed	1050 ± 100 rpm
Rated fuel consumption	164.8 g/Hp·hr at 1950 rpm
Starting motor	(24 V-4.5 kW)
Alternator	Delco Remy (24V-50 A)
Battery	2 × 12 V × 100 Ah

### 2) MAIN PUMP

Item	Specification
Type	Variable displacement tandem axis piston pumps
Capacity	2 × 117cc/rev
Maximum pressure	350kgf/cm <sup>2</sup> (4980psi) [380 kgf/cm <sup>2</sup> (5400 psi)]
Rated oil flow	2 × 222 l /min (58.6U.S. gpm/ 48.8U.K. gpm)
Rated speed	1900 rpm

[ ] : Power boost

### 3) GEAR PUMP

Item	Specification	
	Type	Fixed displacement gear pump single stage
Capacity	15 cc/rev	
Maximum pressure	40 kgf/cm <sup>2</sup> (570 psi)	
Rated oil flow	28.5 l/min (7.5 U.S. gpm/6.3 U.K. gpm)	

### 4) MAIN CONTROL VALVE

Item	Specification		
		R220LC-9	R220LC-9 Long reach
Type	10 spools two-block		
Operating method	Hydraulic pilot system		
Main relief valve pressure	350 kgf/cm <sup>2</sup> (4980 psi) [380 kgf/cm <sup>2</sup> (5400 psi)]		
Port relief valve pressure	Boom	400 kgf/cm <sup>2</sup> (5690 psi)	400 kgf/cm <sup>2</sup> (5690 psi)
	Arm	400 kgf/cm <sup>2</sup> (5690 psi)	300 kgf/cm <sup>2</sup> (4270 psi)
	Bucket	400 kgf/cm <sup>2</sup> (5690 psi)	280 kgf/cm <sup>2</sup> (3980 psi)

[ ]: Power boost

### 5) SWING MOTOR

Item	Specification	
	Type 1	Type 2
Type	Fixed displacement axial piston motor	
Capacity	151 cc/rev	142.8 cc/rev
Relief pressure	265 kgf/cm <sup>2</sup> (3770 psi)	
Braking system	Automatic, spring applied hydraulic released	
Braking torque	59 kgf · m (427 lbf · ft)	58 kgf · m (420 lbf · ft)
Brake release pressure	33~50 kgf/cm <sup>2</sup> (470~711 psi)	21.3~35.6 kgf/cm <sup>2</sup> (154~257 psi)
Reduction gear type	2 - stage planetary	

### 6) TRAVEL MOTOR

Item	Specification	
	Type 1	Type 2, 3
Type	Variable displacement axial piston motor	
Relief pressure	350 kgf/cm <sup>2</sup> (4980 psi)	
Reduction gear type	2-stage planetary	
Braking system	Automatic, spring applied hydraulic released	
Brake release pressure	11 kgf/cm <sup>2</sup> (156 psi)	15.2 kgf/cm <sup>2</sup> (216 psi)
Braking torque	49.3 kgf · m (357 lbf · ft)	65.4 kgf · m (473 lbf · ft)

## 7) REMOTE CONTROL VALVE

Item		Specification
Type		Pressure reducing type
Operating pressure	Minimum	6.5 kgf/cm <sup>2</sup> (92 psi)
	Maximum	25 kgf/cm <sup>2</sup> (356 psi)
Single operation stroke	Lever	90 mm (3.5 in)
	Pedal	130 mm (4.4 in)

## 8) CYLINDER

Item		Specification
Boom cylinder	Bore dia × Rod dia × Stroke	∅ 120 × ∅ 85 × 1290 mm
	Cushion	Extend only
Arm cylinder	Bore dia × Rod dia × Stroke	∅ 140 × ∅ 100 × 1510 mm # ∅ 140 × ∅ 100 × 1460 mm
	Cushion	Extend and retract
Bucket cylinder	Bore dia × Rod dia × Stroke	∅ 120 × ∅ 85 × 1055 mm # ∅ 100 × ∅ 70 × 870 mm
	Cushion	Extend only

※ Discoloration of cylinder rod can occur when the friction reduction additive of lubrication oil spreads on the rod surface.

※ Discoloration does not cause any harmful effect on the cylinder performance.

# : LONG REACH

## 9) SHOE

Item		Width	Ground pressure	Link quantity	Overall width
R220LC-9	Standard	600 mm (24")	0.45 kgf/cm <sup>2</sup> (6.40 psi)	49	2990 mm (9' 10")
	Option	700 mm (28")	0.40 kgf/cm <sup>2</sup> (5.69 psi)	49	3090 mm (10' 2")
		800 mm (32")	0.35 kgf/cm <sup>2</sup> (4.98 psi)	49	3190 mm (10' 6")
		900 mm (36")	0.32 kgf/cm <sup>2</sup> (4.55 psi)	49	3290 mm (10' 10")
R220LC-9 LONG REACH	Standard	800 mm (32")	0.39 kgf/cm <sup>2</sup> (5.55 psi)	49	3190 mm (10' 6")

## 10) BUCKET

Item		Capacity		Tooth quantity	Width		
		SAE heaped	CECE heaped		Without side cutter	With side cutter	
R220LC-9	STD	1.05 m <sup>3</sup> (1.37 yd <sup>3</sup> )	0.90 m <sup>3</sup> (1.18 yd <sup>3</sup> )	5	1250 mm (49.2")	1370 mm (53.9")	
	OPT		0.51 m <sup>3</sup> (0.67 yd <sup>3</sup> )	0.45 m <sup>3</sup> (0.59 yd <sup>3</sup> )	3	700 mm (27.6")	820 mm (32.3")
			0.80 m <sup>3</sup> (1.05 yd <sup>3</sup> )	0.70 m <sup>3</sup> (0.92 yd <sup>3</sup> )	5	1000 mm (39.4")	1120 mm (44.1")
			0.92 m <sup>3</sup> (1.20 yd <sup>3</sup> )	0.80 m <sup>3</sup> (1.05 yd <sup>3</sup> )	5	1150 mm (45.3")	1270 mm (50.0")
			1.20 m <sup>3</sup> (1.57 yd <sup>3</sup> )	1.00 m <sup>3</sup> (1.31 yd <sup>3</sup> )	5	1400 mm (55.1")	1520 mm (59.8")
			1.34 m <sup>3</sup> (1.75 yd <sup>3</sup> )	1.15 m <sup>3</sup> (1.50 yd <sup>3</sup> )	6	1550 mm (61.0")	1670 mm (65.7")
		★	0.52 m <sup>3</sup> (0.68 yd <sup>3</sup> )	0.45 m <sup>3</sup> (0.59 yd <sup>3</sup> )	5	935 mm (36.8")	1035 mm (40.7")
		◆	0.74 m <sup>3</sup> (0.97 yd <sup>3</sup> )	0.65 m <sup>3</sup> (0.85 yd <sup>3</sup> )	5	985 mm (38.8")	-
		◆	0.90 m <sup>3</sup> (1.18 yd <sup>3</sup> )	0.80 m <sup>3</sup> (1.05 yd <sup>3</sup> )	5	1070 mm (42.0")	-
		◆	1.05 m <sup>3</sup> (1.37 yd <sup>3</sup> )	0.92 m <sup>3</sup> (1.20 yd <sup>3</sup> )	5	1290 mm (50.8")	-
		⊙	0.87 m <sup>3</sup> (1.14 yd <sup>3</sup> )	0.75 m <sup>3</sup> (0.98 yd <sup>3</sup> )	5	1140 mm (44.9")	-
		⊙	1.20 m <sup>3</sup> (1.57 yd <sup>3</sup> )	1.00 m <sup>3</sup> (1.31 yd <sup>3</sup> )	5	1410 mm (55.5")	-
		■	0.75 m <sup>3</sup> (0.98 yd <sup>3</sup> )	0.65 m <sup>3</sup> (0.85 yd <sup>3</sup> )	-	1790 mm (70.5")	-

★ : Long reach bucket

◆ : Heavy duty bucket

⊙ : Rock-heavy duty bucket

■ : Slope finishing bucket

## 9. RECOMMENDED OILS

Use only oils listed below or equivalent.

Do not mix different brand oil.

Service point	Kind of fluid	Capacity l (U.S. gal)	Ambient temperature °C ( °F)						
			-50 (-58)	-30 (-22)	-20 (-4)	-10 (14)	0 (32)	10 (50)	20 (68)
Engine oil pan	Engine oil	24 (6.3)	★SAE 5W-40						
			SAE 30						
			SAE 10W						
			SAE 10W-30						
			SAE 15W-40						
Swing drive	Gear oil	5.0 (1.3)	★SAE 75W-90						
Final drive		5.8×2 (1.5×2)	SAE 85W-140						
Hydraulic tank	Hydraulic oil	Tank; 160 (42)	★ISO VG 15						
		System; 275 (73)	ISO VG 46						
			ISO VG 68						
Fuel tank	Diesel fuel	400 (106)	★ASTM D975 NO.1						
			ASTM D975 NO.2						
Fitting (grease nipple)	Grease	As required	★NLGI NO.1						
			NLGI NO.2						
Radiator (reservoir tank)	Mixture of antifreeze and soft water★1	35 (9.2)	Ethylene glycol base permanent type (50 : 50)						
			★Ethylene glycol base permanent type (60 : 40)						

**SAE** : Society of Automotive Engineers

**API** : American Petroleum Institute

**ISO** : International Organization for Standardization

**NLGI** : National Lubricating Grease Institute

**ASTM** : American Society of Testing and Material

★1 : Soft water

City water or distilled water

★ : Cold region