

SECTION 3 HYDRAULIC SYSTEM

Group 1 Hydraulic Circuit	3-1
Group 2 Main Circuit	3-2
Group 3 Pilot Circuit	3-5
Group 4 Single Operation	3-13
Group 5 Combined Operation	3-23

SECTION 3 HYDRAULIC SYSTEM

GROUP 1 HYDRAULIC CIRCUIT

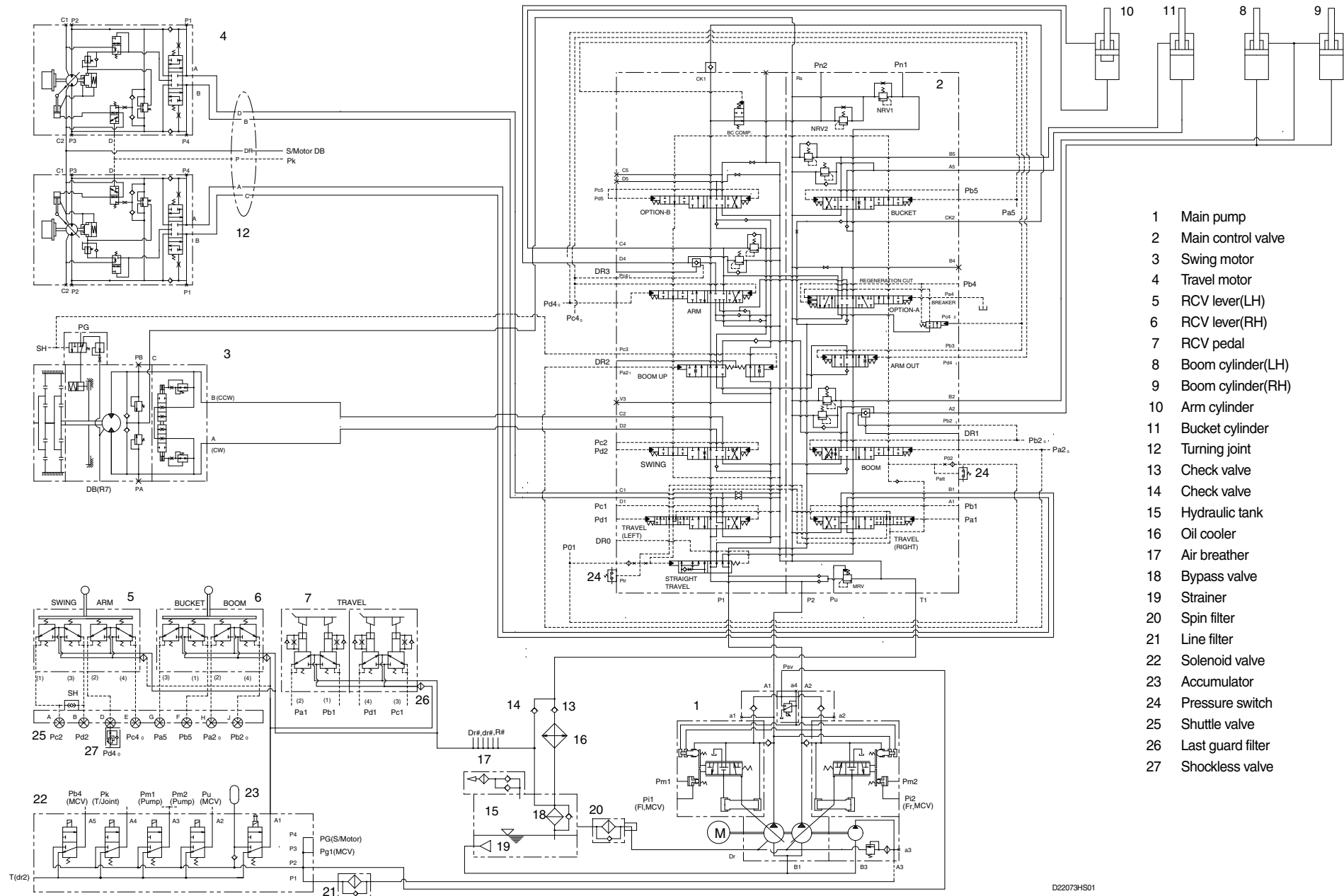

D22073HS01

GROUP 2 MAIN CIRCUIT

The main hydraulic circuit consists of suction circuit, delivery circuit, return circuit and drain circuit.

The hydraulic system consists of one main pump, one control valve, one swing motor, four cylinders and two travel motors.

The swash plate type variable displacement axial piston pump is used as the main pump and is driven by the engine at ratio 1.0 of engine speed.

1. SUCTION AND DELIVERY CIRCUIT

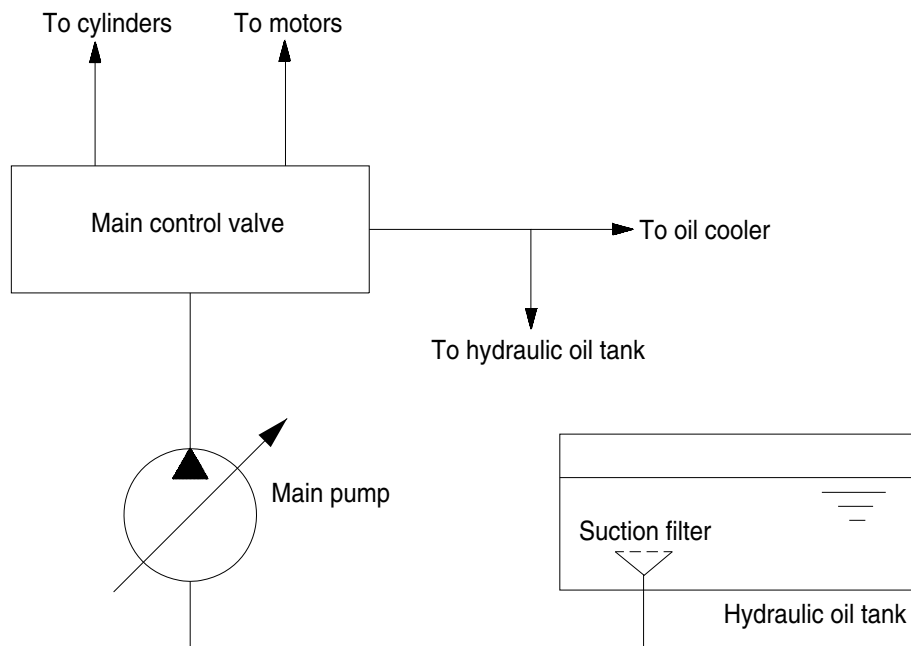

(210-7) 3-03

The pumps receive oil from the hydraulic tank through a suction filter. The discharged oil from the pump flows into the control valve and goes out the tank ports.

The oil discharged from the main pump flows to the actuators through the control valve.

The control valve controls the hydraulic functions.

The return oil from the actuators flows to the hydraulic tank through the control valve and the oil cooler.

2. RETURN CIRCUIT

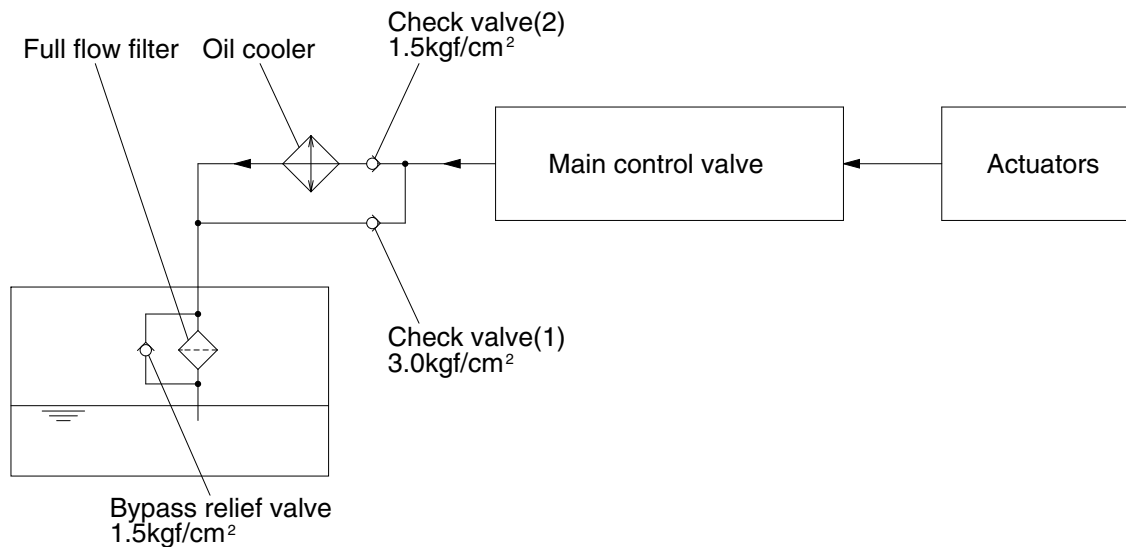

21073CI01

All oil returned from each actuator returns to the hydraulic tank through the control valve.

The bypass check valves are provided in the return circuit.

The setting pressure of bypass check valves are 1.5kgf/cm^2 (21psi) and 3.0kgf/cm^2 (43psi). Usually, oil returns to the hydraulic tank from the left side of control valve through oil cooler.

When oil temperature is low, viscosity becomes higher and flow resistance increases when passing through the oil cooler. When the oil pressure exceeds 3.0kgf/cm^2 (43psi), the oil returns directly to the hydraulic tank, resulting in the oil temperature being raised quickly at an appropriate level.

When the oil cooler is clogged, the oil returns directly to the hydraulic tank through bypass check valve(1).

The full-flow filter and bypass relief valve are provided in the hydraulic tank.

The oil returned from right and left side of control valve is combined and filtered by the full-flow filter. A bypass relief valve is provided in the full-flow filter.

When the filter element is clogged, the bypass relief valve opens at 1.5kgf/cm^2 (21psi) differential pressure.

3. DRAIN CIRCUIT

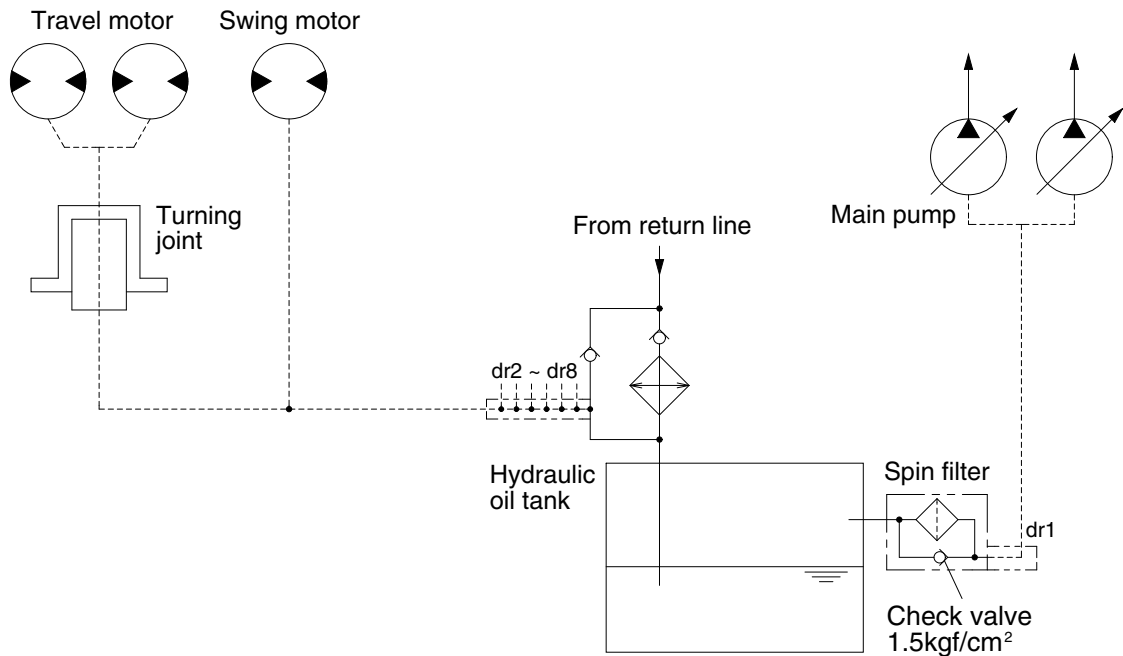

21073CI02

Besides internal leaks from the motors and main pump, the oil for lubrication circulates. These oil have to be fed to the hydraulic tank passing through spin filter.

When the drain oil pressure exceed 1.5kgf/cm^2 (21psi), the oil returns to the hydraulic tank directly.

1) TRAVEL MOTOR DRAIN CIRCUIT

Oil leaked from the right and left travel motors comes out of the drain ports provided in the respective motor casing and join with each other. These oils pass through the turning joint and return to the hydraulic tank after being filtered by spin filter.

2) SWING MOTOR DRAIN CIRCUIT

Oil leaked from the swing motor returns to the hydraulic tank passing through a spin filter with oil drained from the travel circuit .

3) MAIN PUMP DRAIN CIRCUIT

Oil leaked from main pump returns to the hydraulic tank passing through spin filter.

GROUP 3 PILOT CIRCUIT

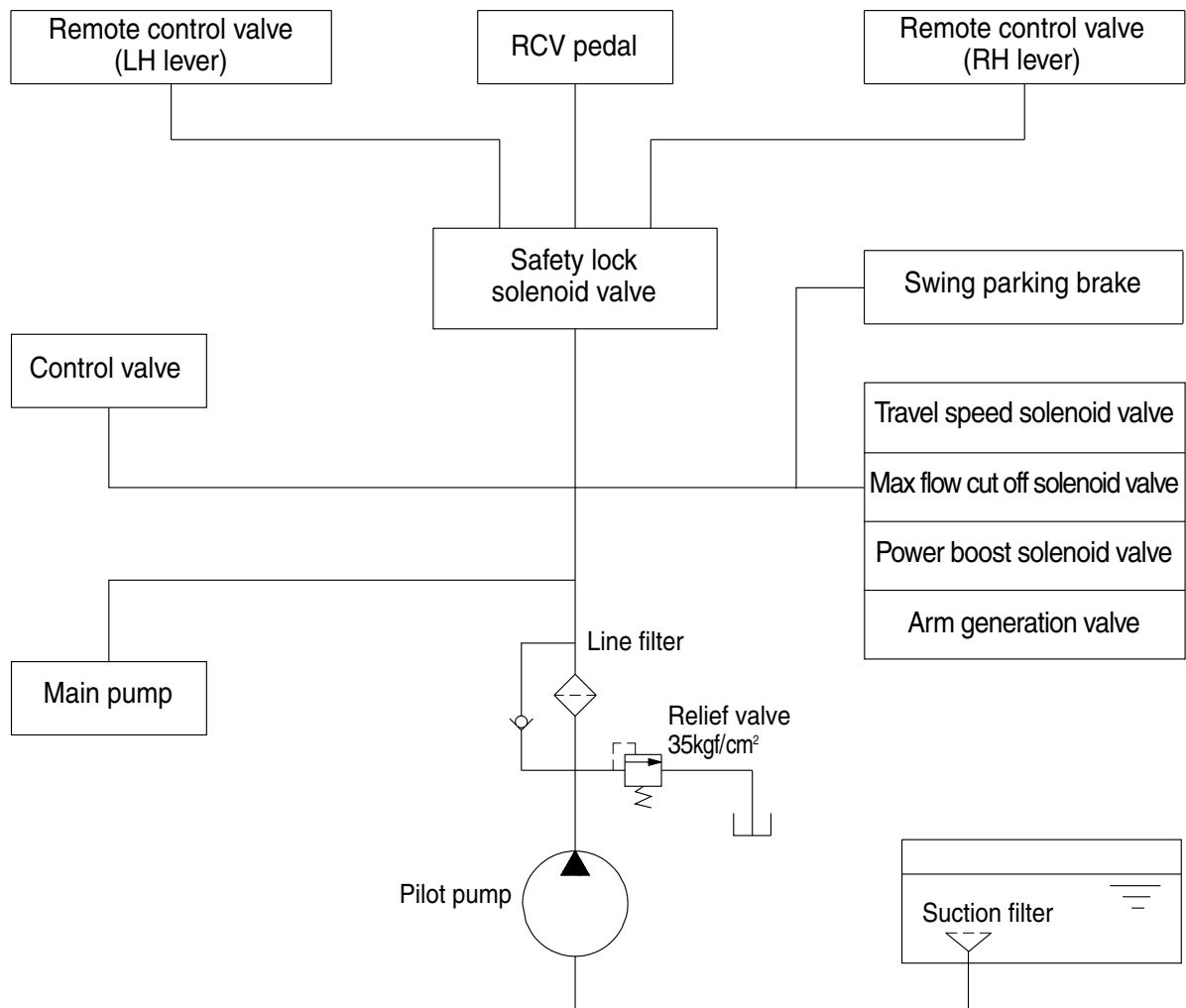

(210-7) 3-05

The pilot circuit consists of suction circuit, delivery circuit and return circuit.

The pilot pump is provided with relief valve, receives the oil from the hydraulic tank through the suction filter.

The discharged oil from the pilot pump flows to the remote control valve through line filter, EPPR valve, solenoid valve assemblies, swing parking brake, main control valve and safety lock solenoid valve.

1. SUCTION, DELIVERY AND RETURN CIRCUIT

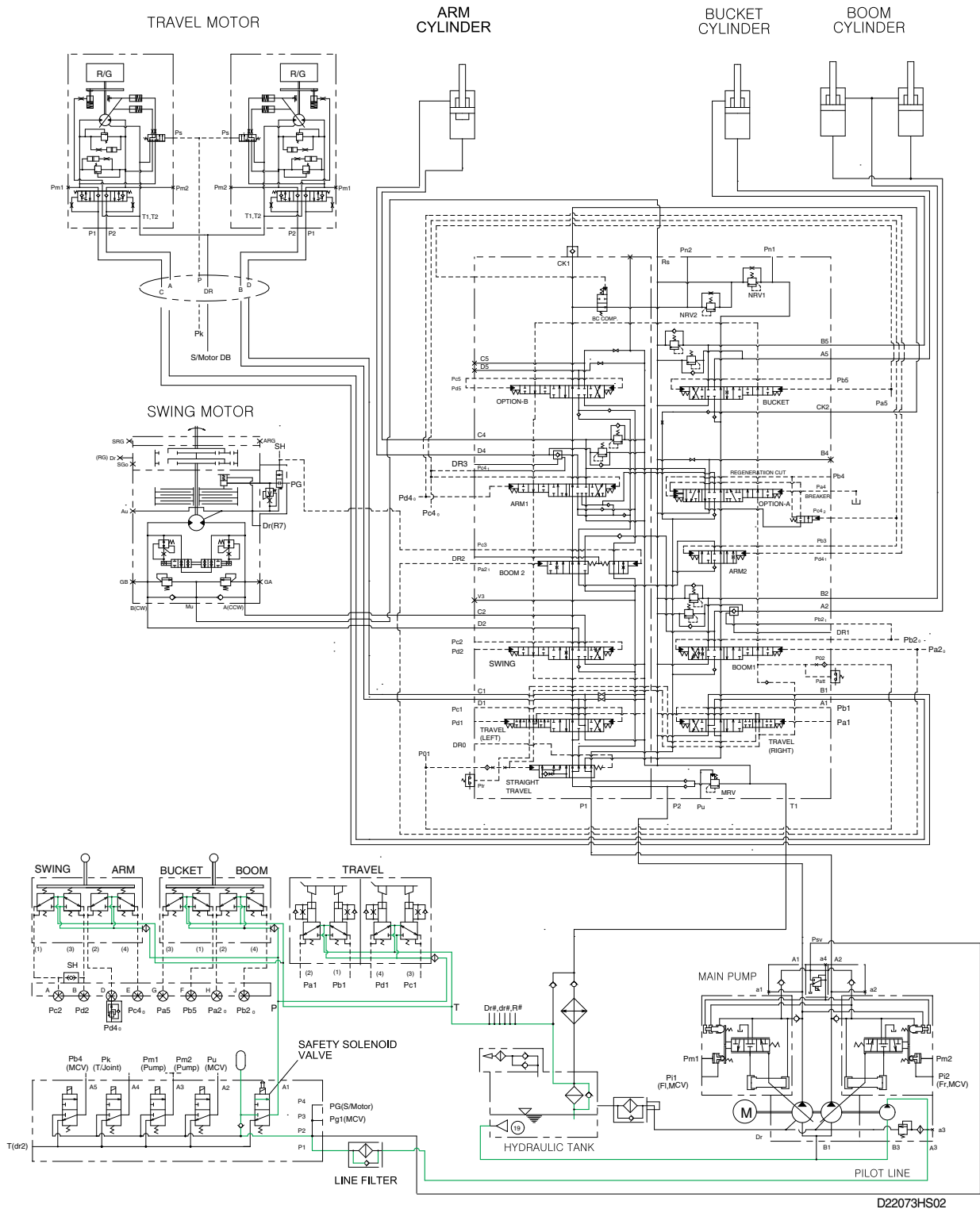

The pilot pump receive oil from the hydraulic tank. The discharged oil from the pilot pump flows to the safety solenoid valve through the line filter. The oil is filtered by the line filter. The pilot relief valve is provided in the pilot pump for limiting the pilot circuit pressure. The oil filtered by line filter flows remote control valve through safety solenoid valve. The return oil flow into the hydraulic tank.

2. SAFETY VALVE(SAFETY LEVER)

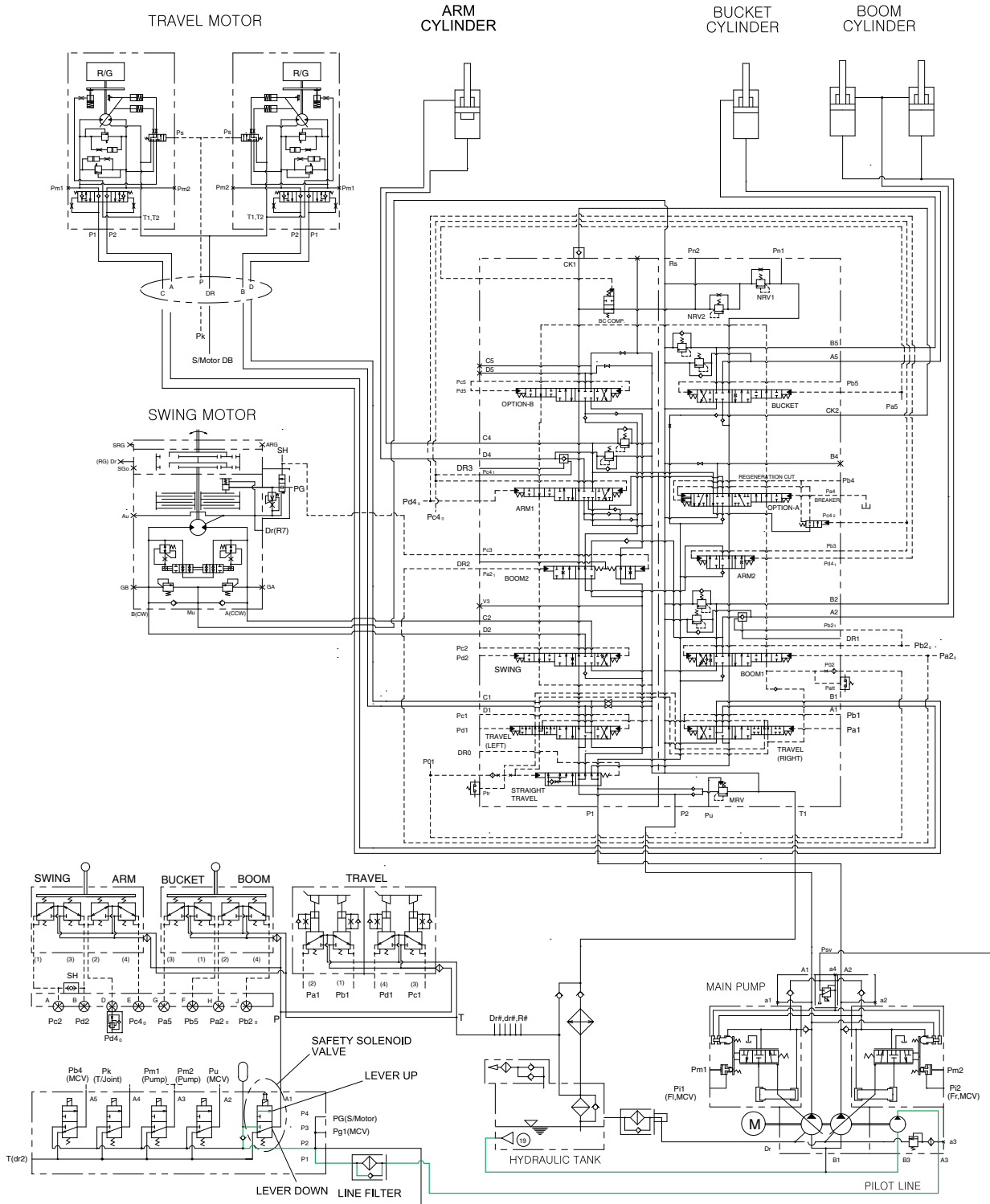

D22073HS03

When the lever of the safety solenoid valve is moved downward, oil flows into the remote control valve through solenoid valve and line filter.

When the lever of the safety solenoid valve is moved upward, oil does not flow into the remote control valve, because of the blocked port.

3. SWING PRIORITY SYSTEM

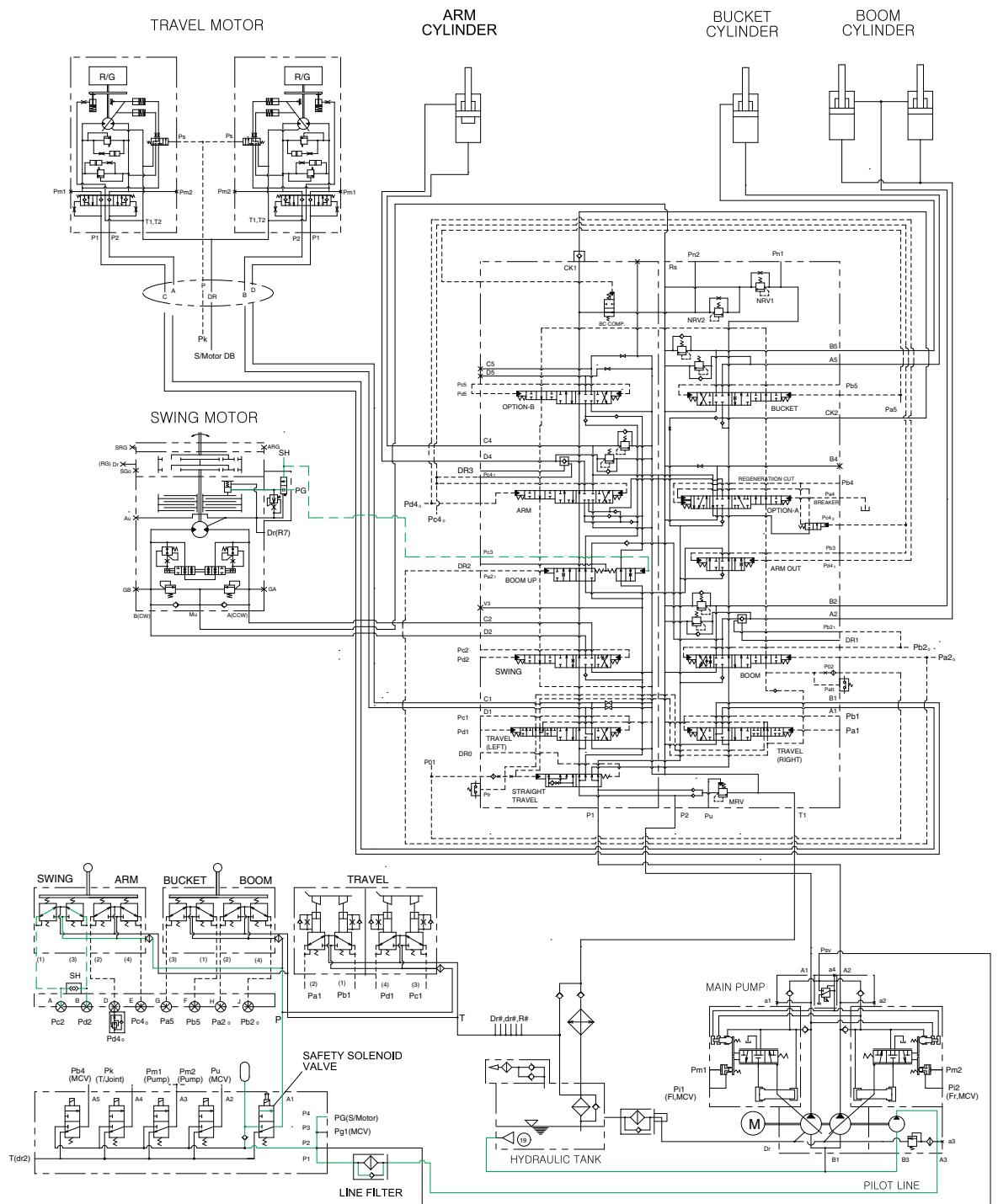

D22073HS04

When carrying out the combined operation of swing and arm of the leftcontrol valve, the swing speed can be lowered than operating speed of arm. Pc3 pressure from the swing shuttle block change the swing priority spool and decreases the oil flow rate to the next section to make the swing operation most preferential. This is called the swing priority system. For details, refer to page 2-44.

4. TRAVEL SPEED CONTROL SYSTEM

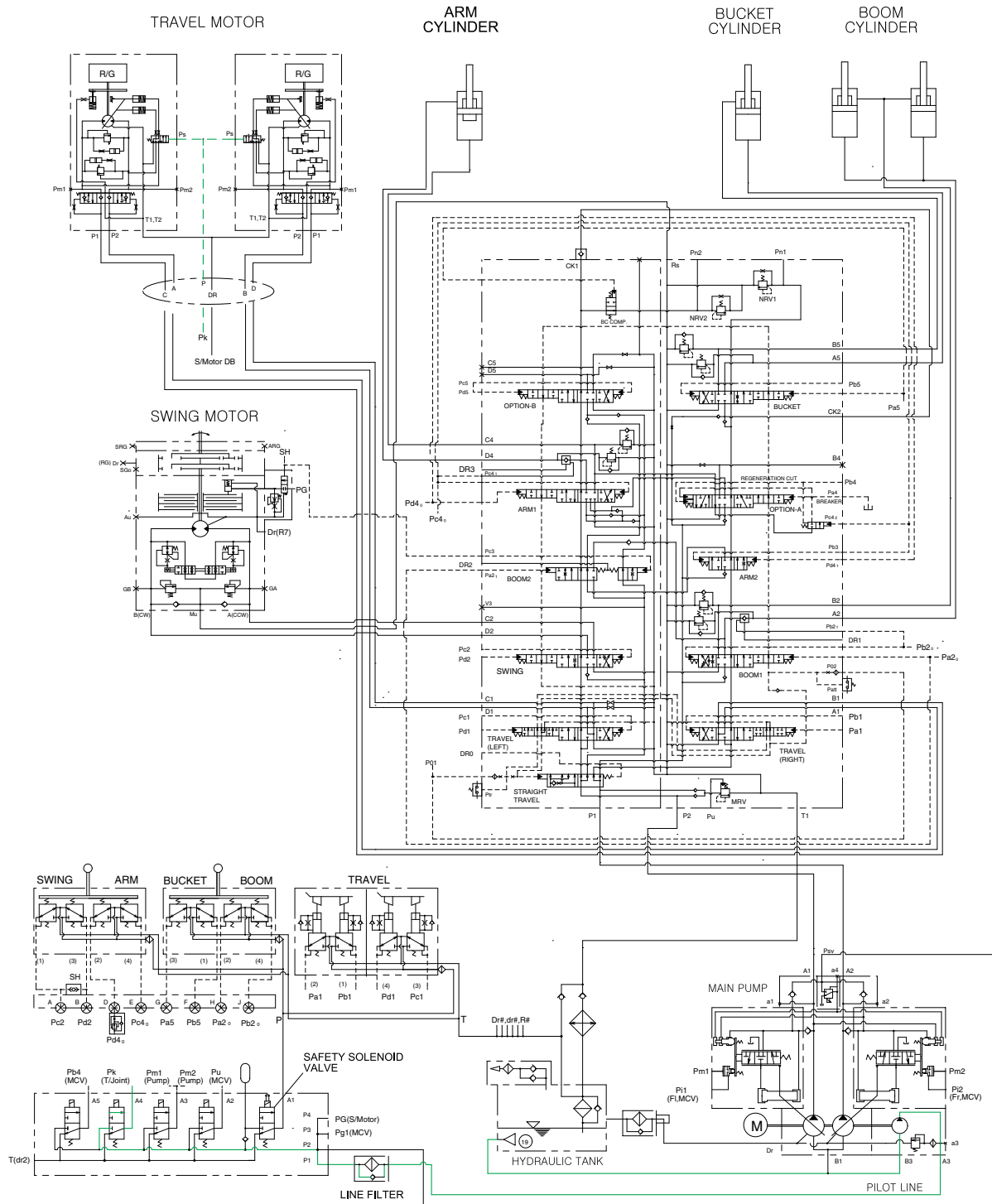

D22073HS05

When the travel speed switch is pushed, the travel speed solenoid valve is actuated and the discharged oil from the pilot pump flows to the Pk port of pilot valve in the travel motors. As a result, the control piston is pushed by the main oil flow, thus the displacement is minimized. When the travel speed switch is pushed once more, the travel speed solenoid valve is return to original position by the force of spring, the hydraulic oil of Pk port returns to the hydraulic tank. As a result, the control piston is returned by the main oil flow, thus the displacement is maximized.

5. MAIN RELIEF PRESSURE CHANGE SYSTEM

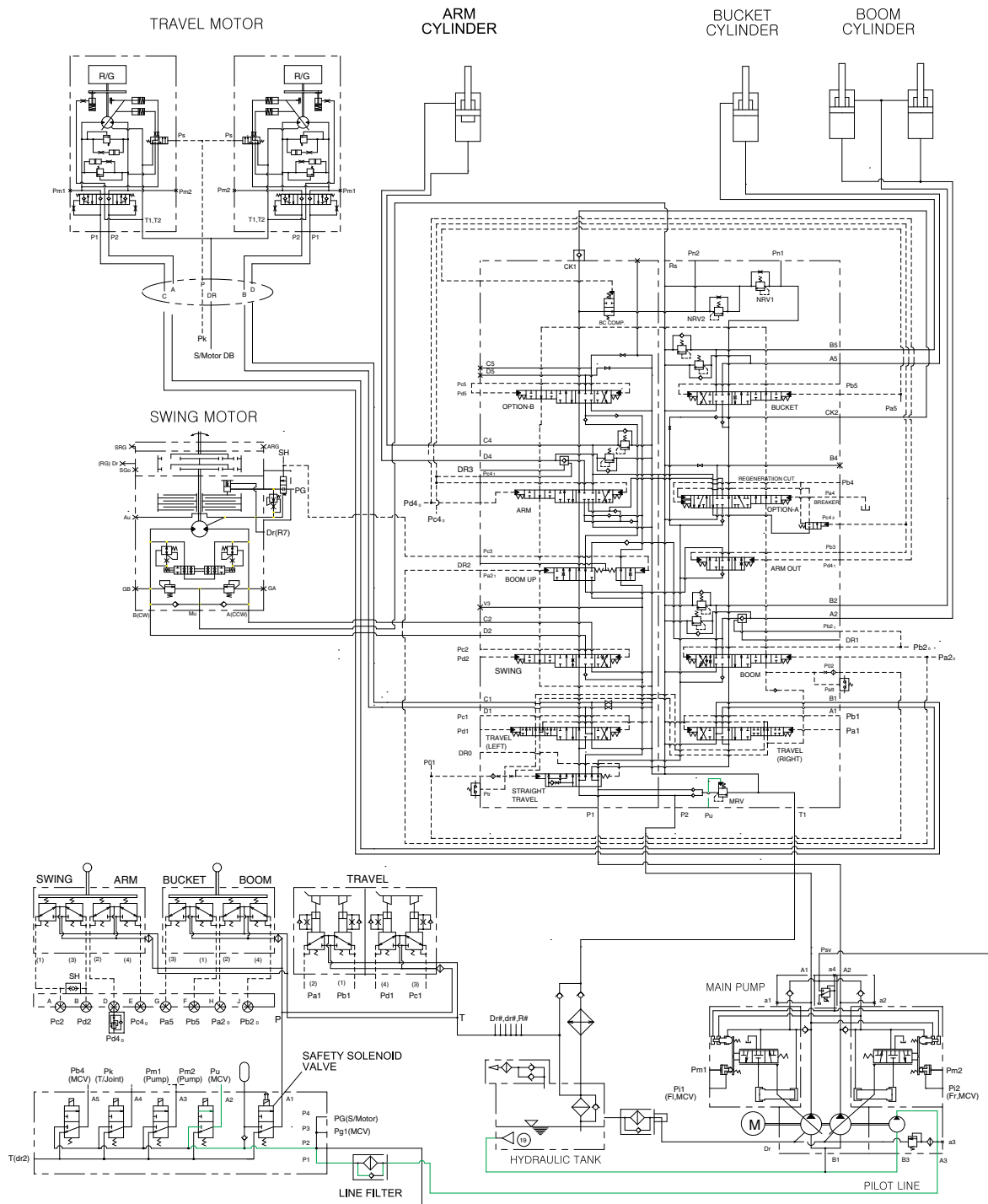

D22073HS06-1

When the power boost switch on the left control lever is pushed ON, the power boost solenoid valve is actuated, the discharged oil from the pilot pump flows into Pu port of the main relief valve of main control valve; then the setting pressure of the main relief valve is raised from 330kgf/cm² to 360kgf/cm² for increasing the digging power. And even when pressed continuously, it is canceled after 8 seconds.

6. MAX FLOW CUT OFF SYSTEM

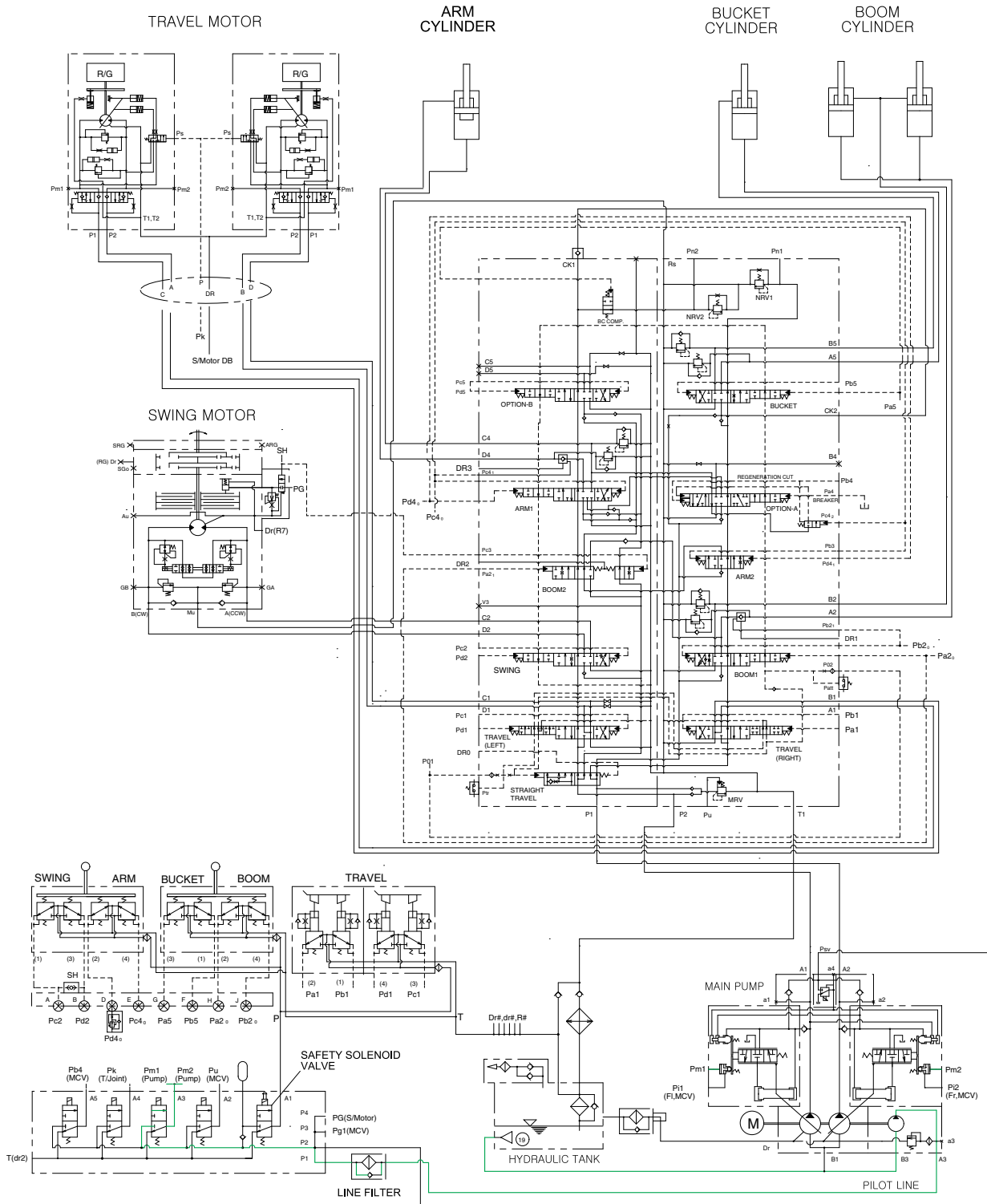

D22073HS07-1

When the breaker operation mode is selected on the cluster, max flow cut off solenoid valve actuates automatically.

Thus pilot pressure(Pm1,2) is sent to the regulator and pump discharge volume is decreased.

7. SWING PARKING BRAKE RELEASE

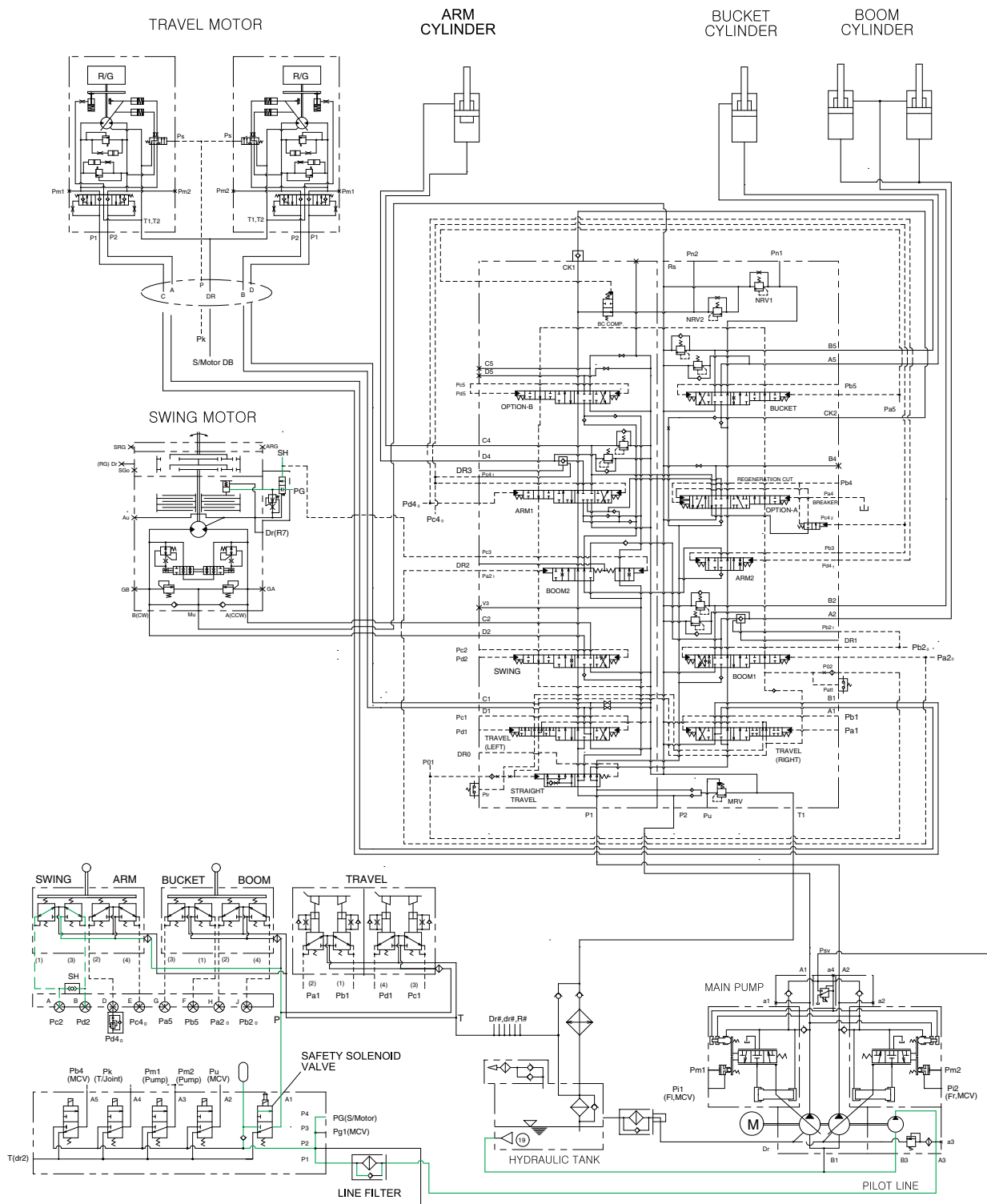

D22073HS08

When the swing control lever is tilted, the pilot oil flow into SH port of shuttle valve, this pressure move spool so, discharged oil from pilot valve flow into PG port.

This pressure is applied to swing motor disc, thus the brake is released.

When the swing control lever is set in the neutral position, oil in the swing motor disc cylinder is drained, thus the brake is applied.

GROUP 4 SINGLE OPERATION

1. BOOM UP OPERATION

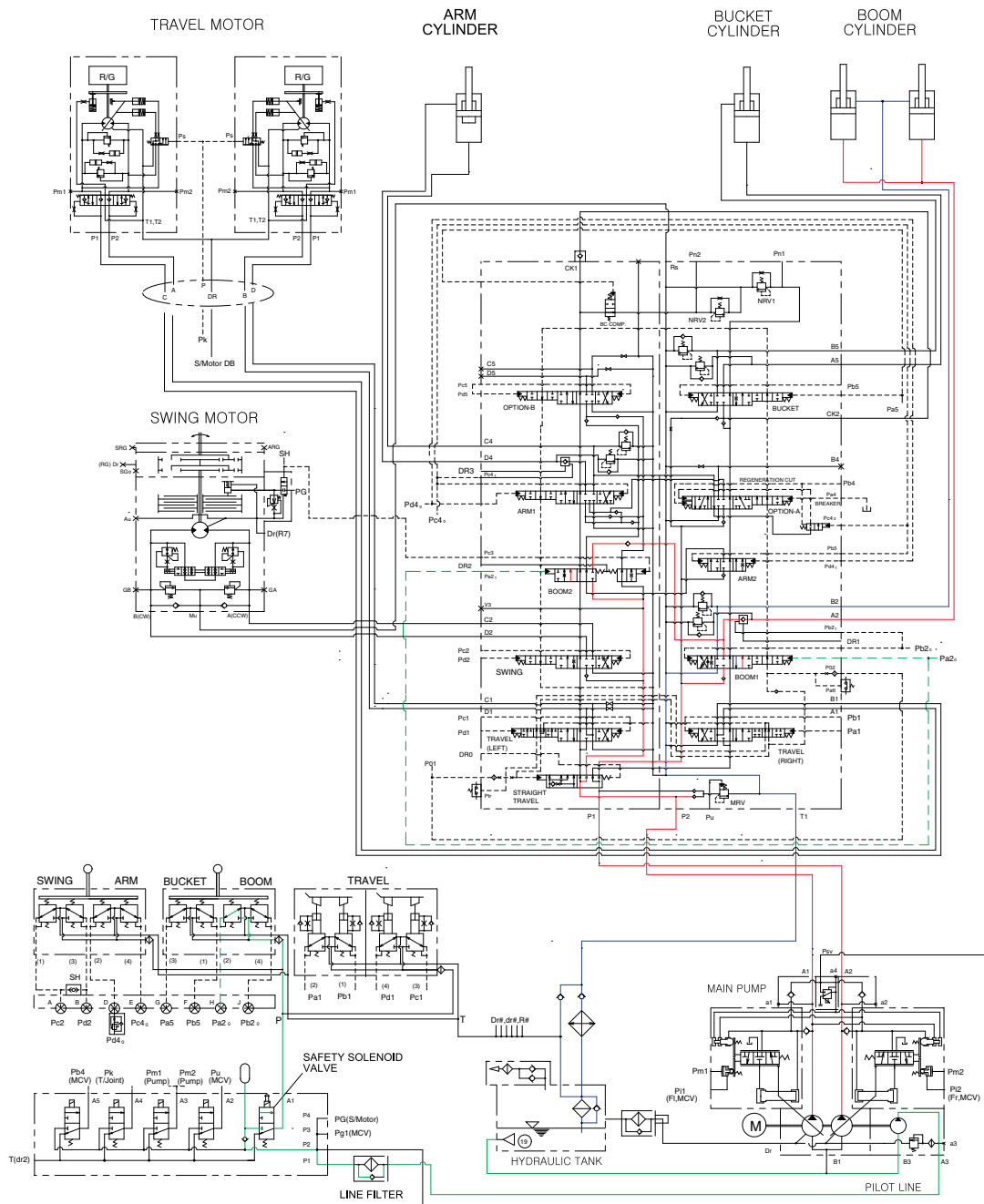

D22073HS09

When the right control lever is pulled back, the boom spools in the main control valve are moved to the up position by the pilot oil pressure from the remote control valve. The oil from the front and rear pump flows into the main control valve and then goes to the large chamber of boom cylinders. At the same time, the oil from the small chamber of boom cylinders returns to the hydraulic oil tank through the boom spool in the main control valve. When this happens, the boom goes up. The excessive pressure in the boom cylinder bottom end circuit is prevented by relief valve. When the boom is up and the control lever is returned to neutral position, the circuit for the holding pressure at the bottom end of the boom cylinder is closed by the boom holding valve. This prevents the hydraulic drift of boom cylinder.

2. BOOM DOWN OPERATION

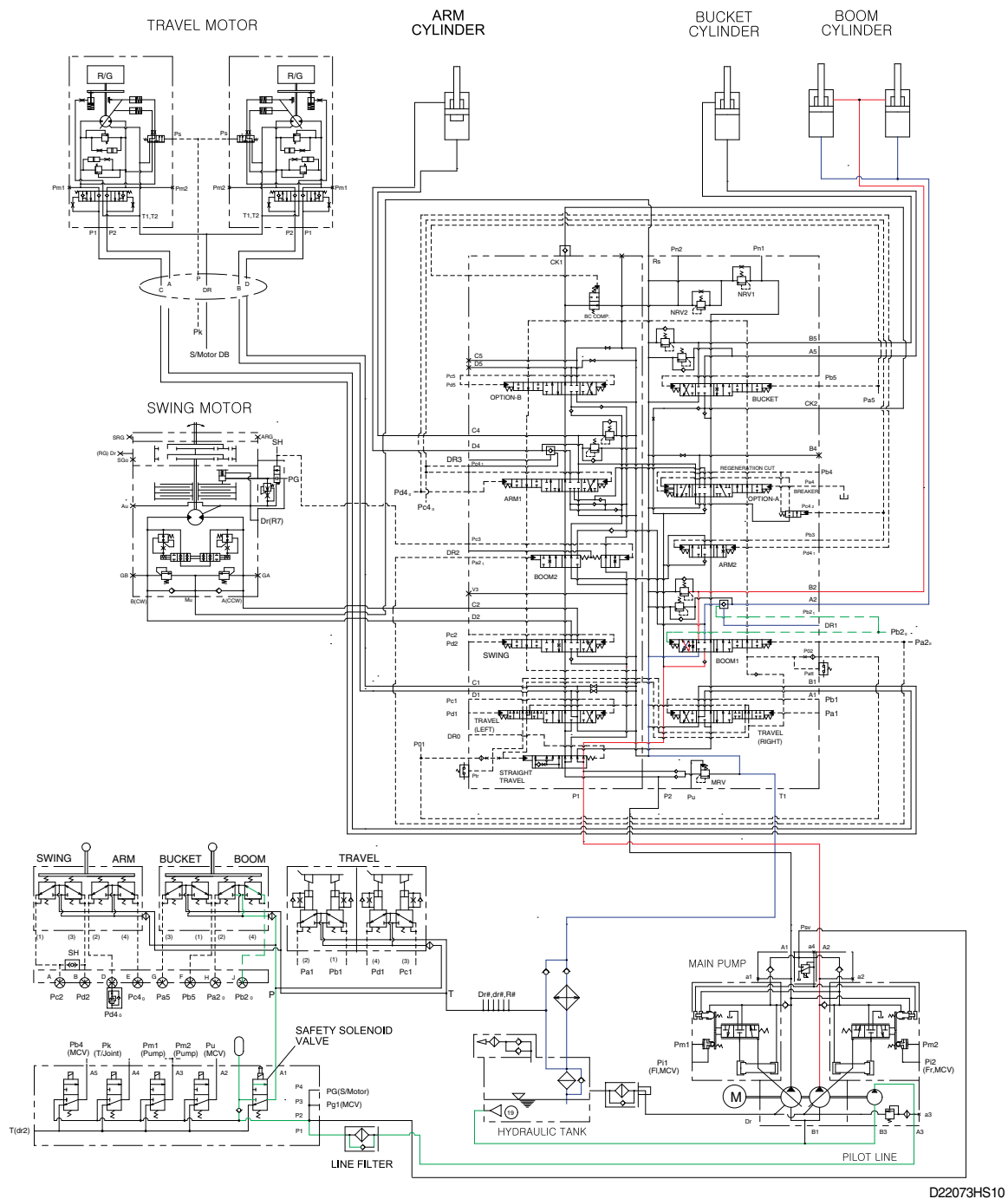

When the right control lever is pushed forward, the boom spools in the main control valve are moved to the down position by the pilot oil pressure from the remote control valve.

The oil from the rear pump flows into the main control valve and then goes to the small chamber of boom cylinders. At the same time, the oil from the large chamber of boom cylinders returns to the hydraulic tank through the boom spool in the main control valve.

When the down speed of boom is faster, the oil returned from the large chamber of boom cylinder combines with the oil from the rear pump, and flows into the small chamber of the cylinder.

This prevents cylinder cavitation by the negative pressure when the rear pump flow can not match the boom down speed. And the excessive pressure in the boom cylinder rod end circuit is prevented by the relief valve.

3. ARM ROLL IN OPERATION

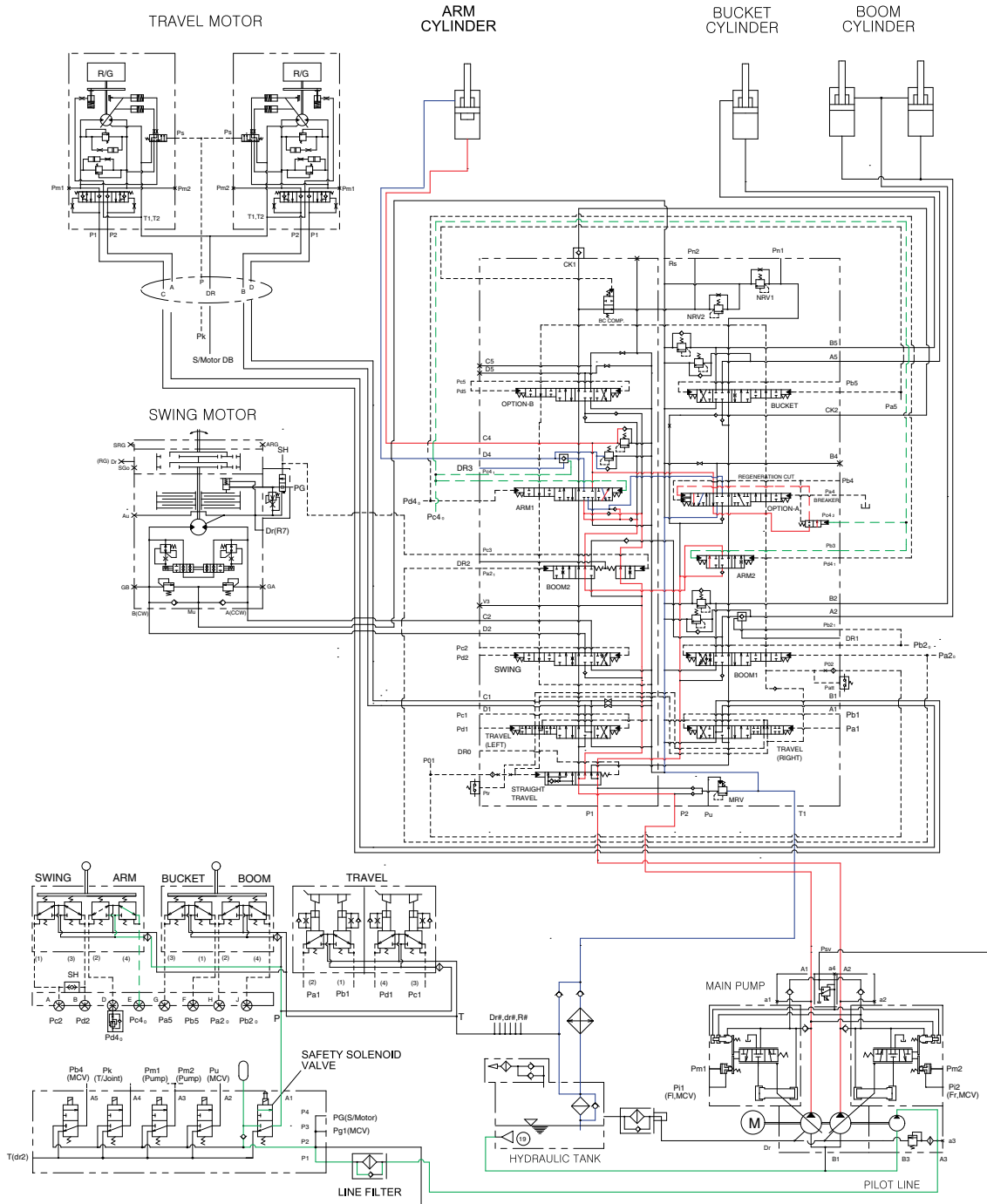

D22073HS11

When the left control lever is pulled back, the arm spools in the main control valve are moved to the roll in position by the pilot oil pressure from the remote control valve. The oil from the front and rear pump flows into the main control valve and then goes to the large chamber of arm cylinder. At the same time, the oil from small chamber of arm cylinder returns to the hydraulic oil tank through the arm spool in the main control valve. When this happens, the arm rolls in. The cavitation which will happen to the bottom of the arm cylinder is also prevented by the make-up valve in the main control valve.

4. ARM ROLL OUT OPERATION

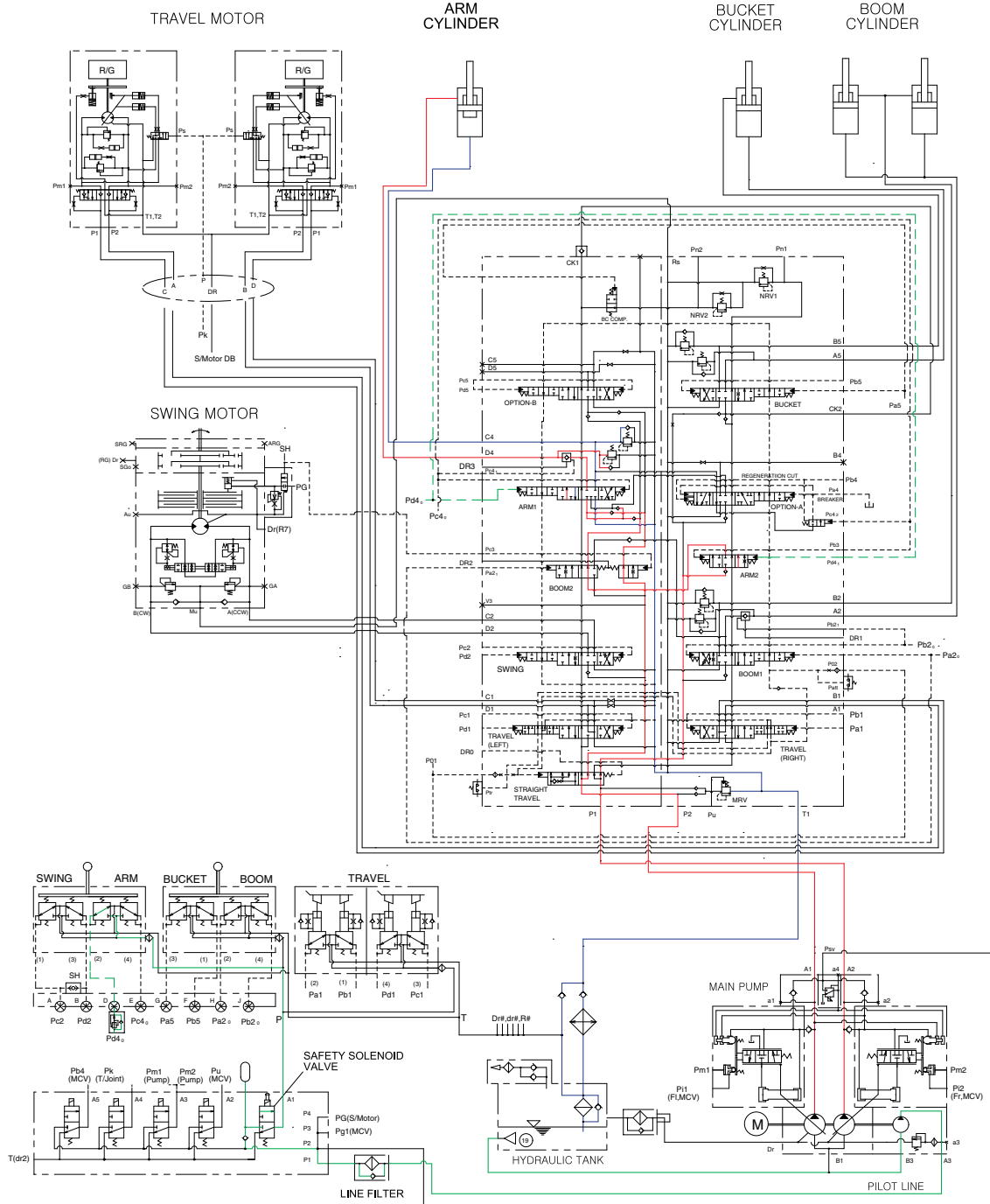

D22073HS12

When the left control lever is pushed forward, the arm spool in the main control valve are moved to the roll out position by the pilot oil pressure from the remote control valve.

The oil from the front and rear pump flows into the main control valve and then goes to the small chamber of arm cylinder.

At the same time, the oil from the large chamber of arm cylinder returns to the hydraulic oil tank through the arm spool in the main control valve. When this happens, the arm rolls out.

The cavitation which will happen to the rod of the arm cylinder is also prevented by the make-up valve in the main control valve.

5. BUCKET ROLL IN OPERATION

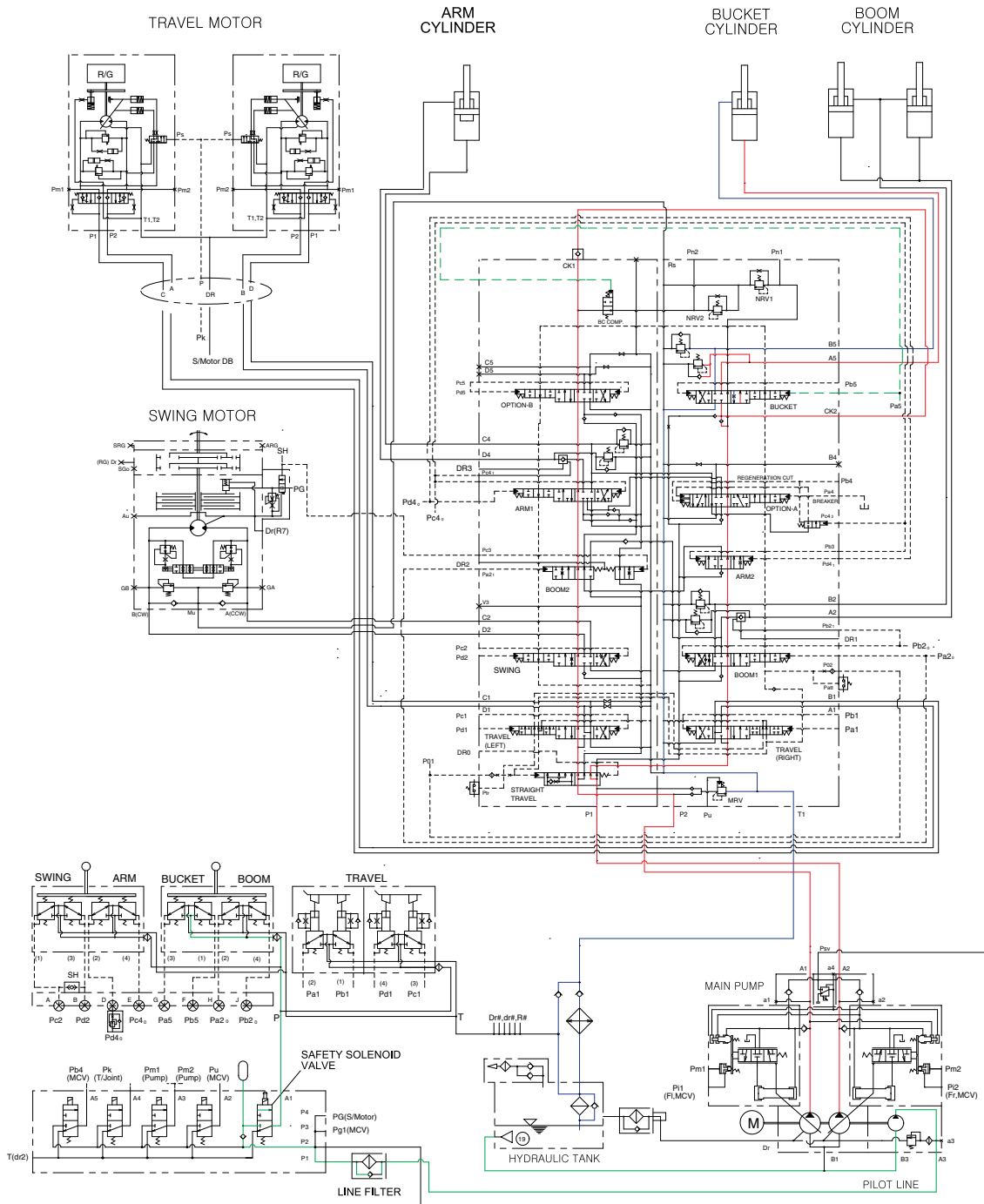

D22073HS13

When the right control lever is pulled left, the bucket spool in the main control valve is moved to the roll in position by the pilot oil pressure from the remote control valve.

The oil from the rear pump flows into the main control valve and then goes to the large chamber of bucket cylinder.

At the same time, the oil from the small chamber of bucket cylinder returns to the hydraulic oil tank through the boom spool in the main control valve. When this happens, the bucket rolls in.

The cavitation which will happen to the bottom of the bucket cylinder is also prevented by the make-up valve in the main control valve.

6. BUCKET ROLL OUT OPERATION

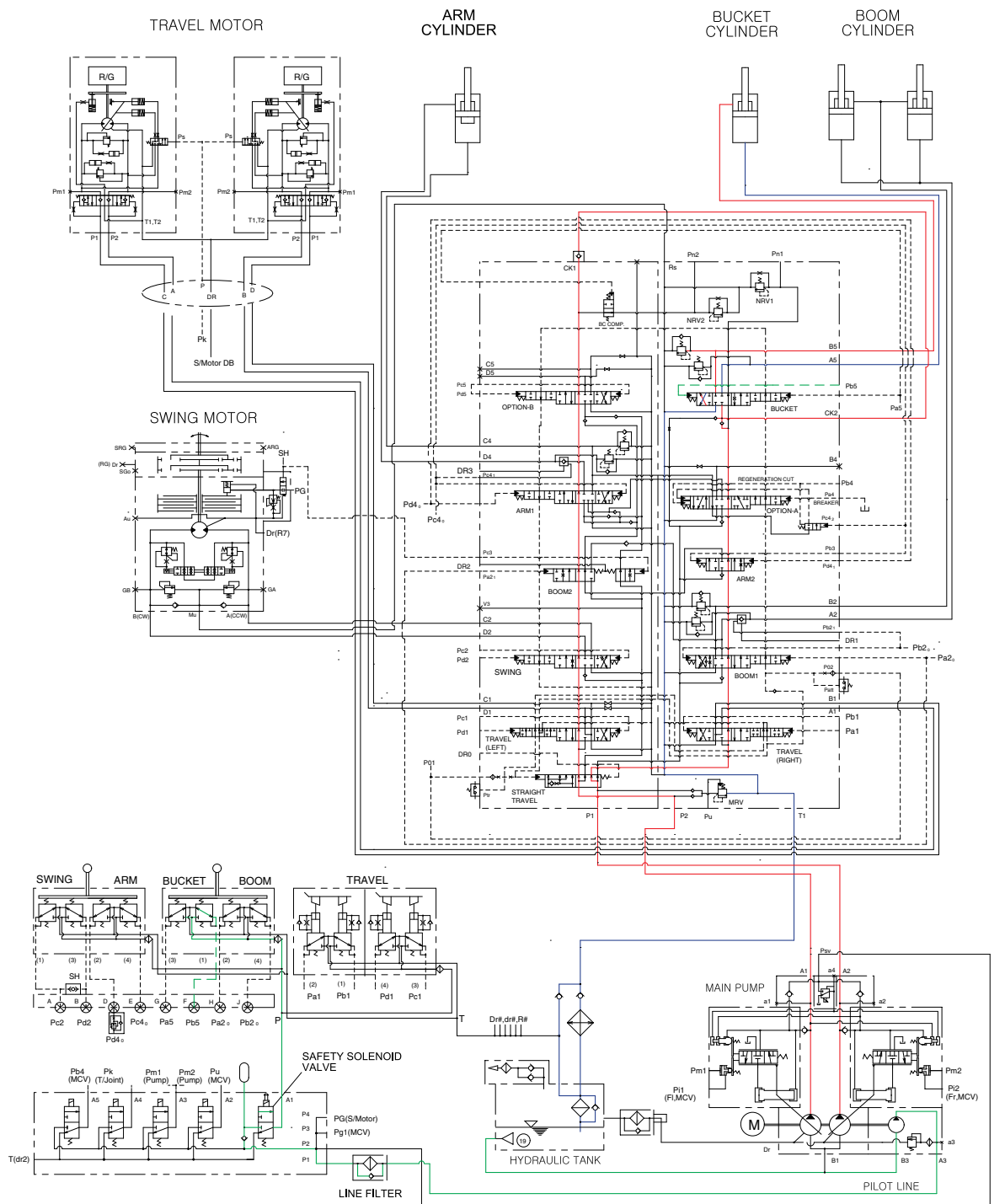

D22073HS14

When the right control lever is pushed right, the bucket spool in the main control valve is moved to the roll out position by the pilot oil pressure from the remote control valve.

The oil from the front pump flows into the main control valve and then goes to the small chamber of bucket cylinder.

At the same time, the oil from the large chamber of bucket cylinder returns to the hydraulic oil tank through the bucket spool in the main control valve. When this happens, the bucket rolls out.

The cavitation which will happen to the rod of the bucket cylinder is also prevented by the make-up valve in the main control valve.

7. SWING OPERATION

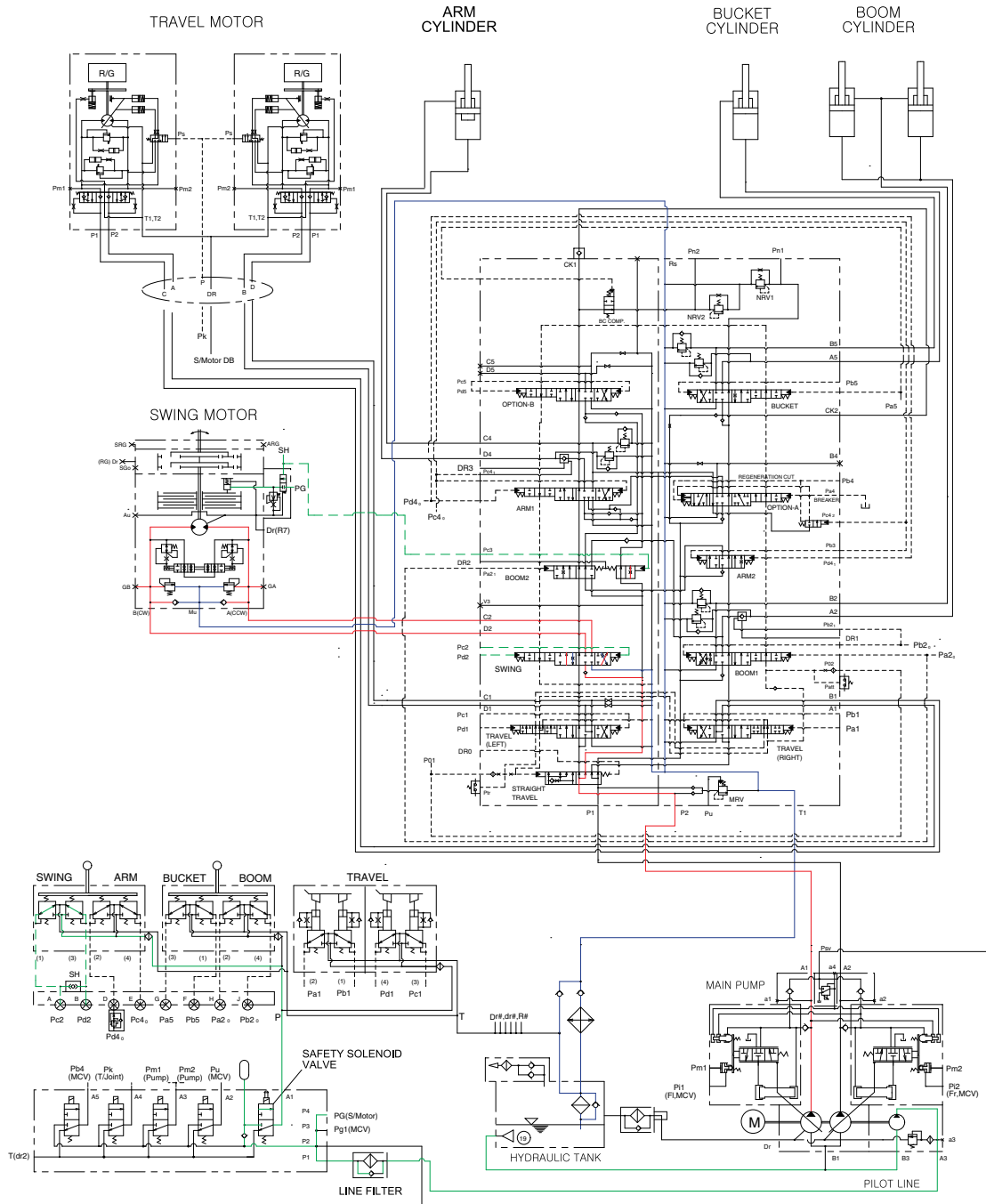

D22073HS15

When the left control lever is pushed left or right, the swing spool in the main control valve is moved to the left or right swing position by the pilot oil pressure from the remote control valve.

The oil from the rear pump flows into the main control valve and then goes to the swing motor.

At the same time, the return oil from the swing motor returns to the hydraulic oil tank through the swing spool in the main control valve.

When this happens, the superstructure swings to the left or right.

The swing parking brake, make up valve and the overload relief valve are provided in the swing motors. The cavitation which will happen to the swing motor is also prevented by the make up valve in the swing motor itself.

SWING CIRCUIT OPERATION

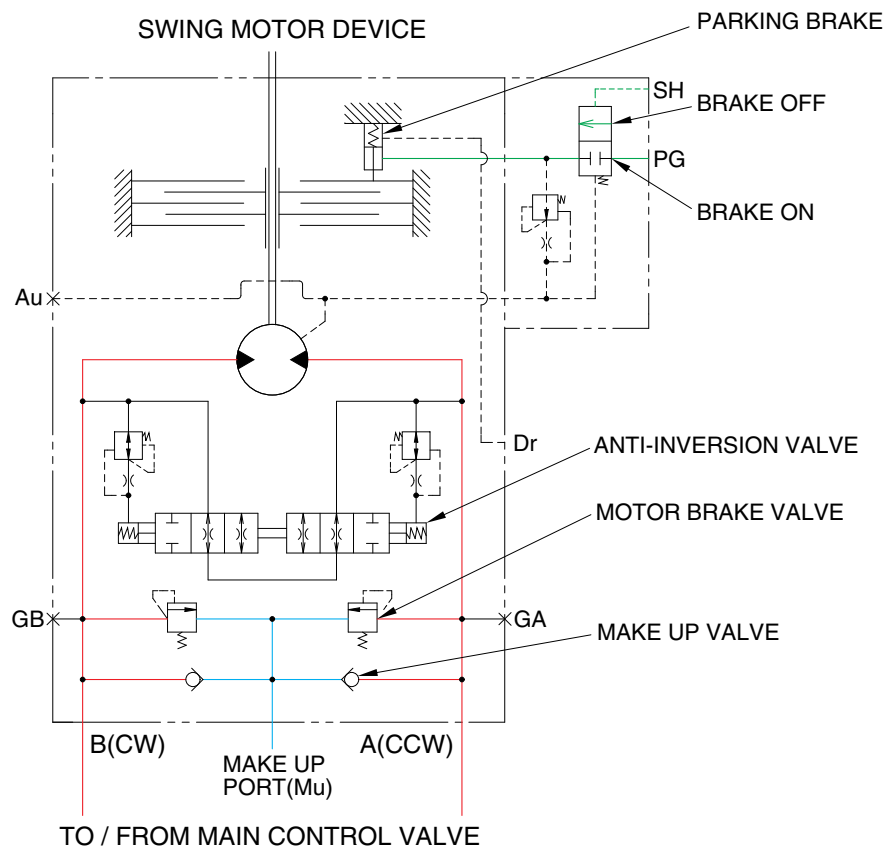

21073HS15A

1) MOTOR BRAKE VALVE

Motor brake valve for the swing motor limits to cushion the starting and stopping pressure of swing operation.

2) MAKE UP VALVE

The make up valves prevent cavitation by supplying return oil to the vacuum side of the motor.

3) PARKING BRAKE

In case that the parking, of the machine at slope is required during operation, there is the danger of involuntary swing caused by the self weight of the machine. The brake is connected to prevent this involuntary swing.

PARKING BRAKE "OFF" OPERATION

The parking brake is released by the pilot pressure oil from the pilot pump.

When the left control lever placed in the swing position, the pilot pressure at the shuttle valve is transferred to the brake release valve and the brake release valve is change over. Then the pilot pressure lift the brake piston and release the parking brake.

PARKING BRAKE "ON" OPERATION

When the control lever placed in the neutral position, the pressure of the pilot oil passage down.

Then the brake release valve returned to the neutral position and the oil is returned from the brake piston to the tank. And the brake is set to 'ON'.

BYPASS VALVE

This bypass valve absorbs shocks produced as swing motion stops and reduced oscillation cause by swing motion.

8. TRAVEL FORWARD AND REVERSE OPERATION

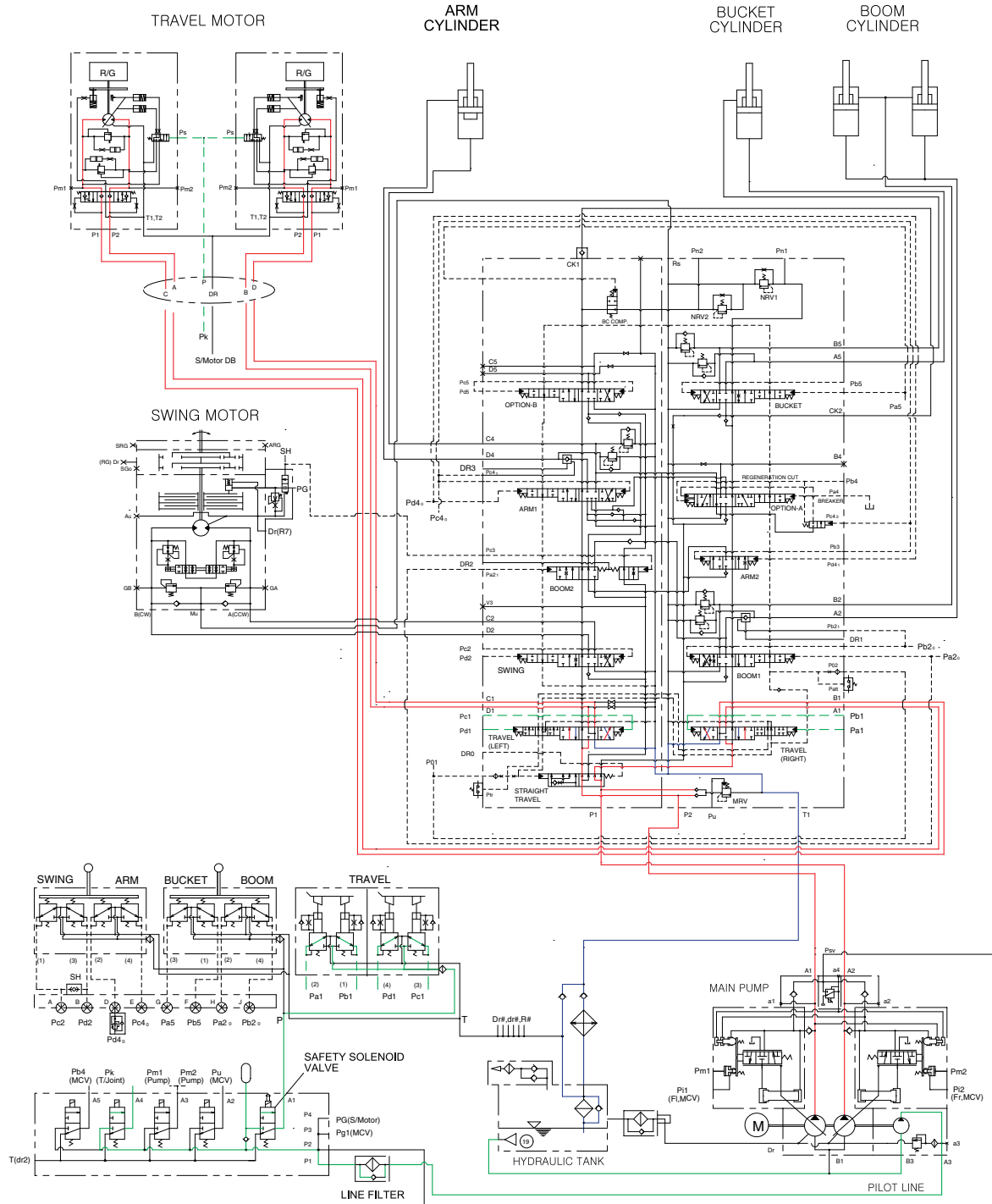

D22073HS16

When the travel levers are pushed forward or reverse position, the travel spools in the main control valve are moved to the forward or reverse travel position by the pilot oil pressure from the remote control valve.

The oil from the both pumps flows into the main control valve and then goes to the both travel motors through the turning joint.

The return oil from both travel motors returns to the hydraulic oil tank through the turning joint and the travel spools in the main control valve.

When this happens, the machine moves to the forward or reverse.

TRAVEL CIRCUIT OPERATION

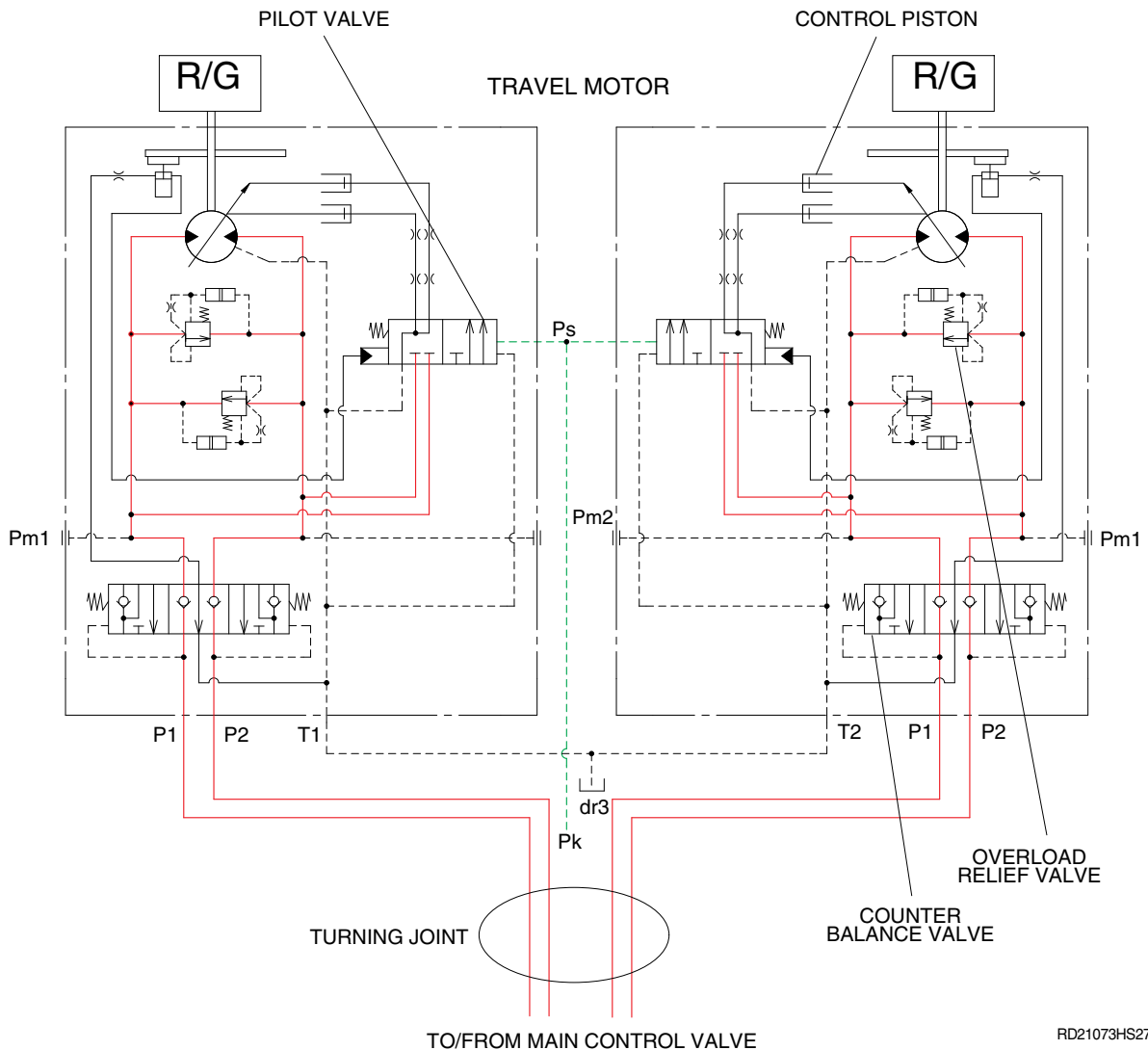

RD21073HS27

Valves are provided on travel motors to offer the following functions.

1) COUNTER BALANCE VALVE

When stopping the motor of slope descending, this valve to prevent the motor over run.

2) OVERLOAD RELIEF VALVE

Relief valve limit the circuit pressure below 365kgf/cm² to prevent high pressure generated at at time of stopping the machine. Stopping the motor, this valve sucks the oil from lower pressure passage for preventing the negative pressure and the cavitation of the motor.

GROUP 5 COMBINED OPERATION

1. OUTLINE

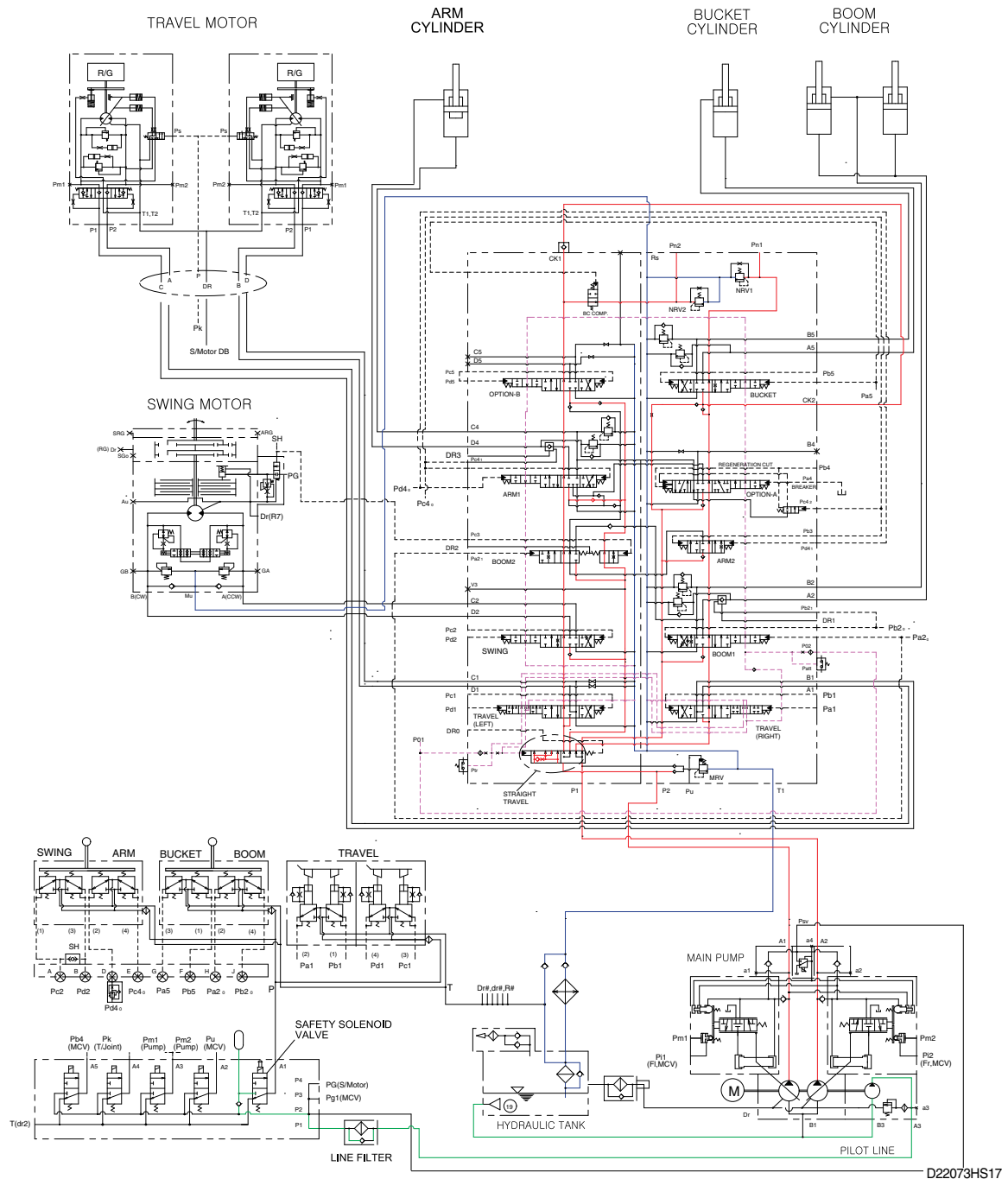

The oil from the front and rear pump flows through the neutral oil passage, bypass oil passage and confluence oil passage in the main control valve. Then the oil goes to each actuator and operates them. Check valves and orifices are located on these oil passage in the main control valve. These control the oil from the main pumps so as to correspond to the operation of each actuator and smooth the combined operation.

STRAIGHT TRAVEL SPOOL

This straight travel spool for straight travel is provided in the main control valve.

If any actuator is operated when traveling, the straight travel spool is pushed to the left by the pilot oil pressure.

Consequently, the left and right travel oil supply passage are connected, and equivalent amount of oil flows into the left and right travel motors. This keeps the straight travel.

2. COMBINED SWING AND BOOM OPERATION

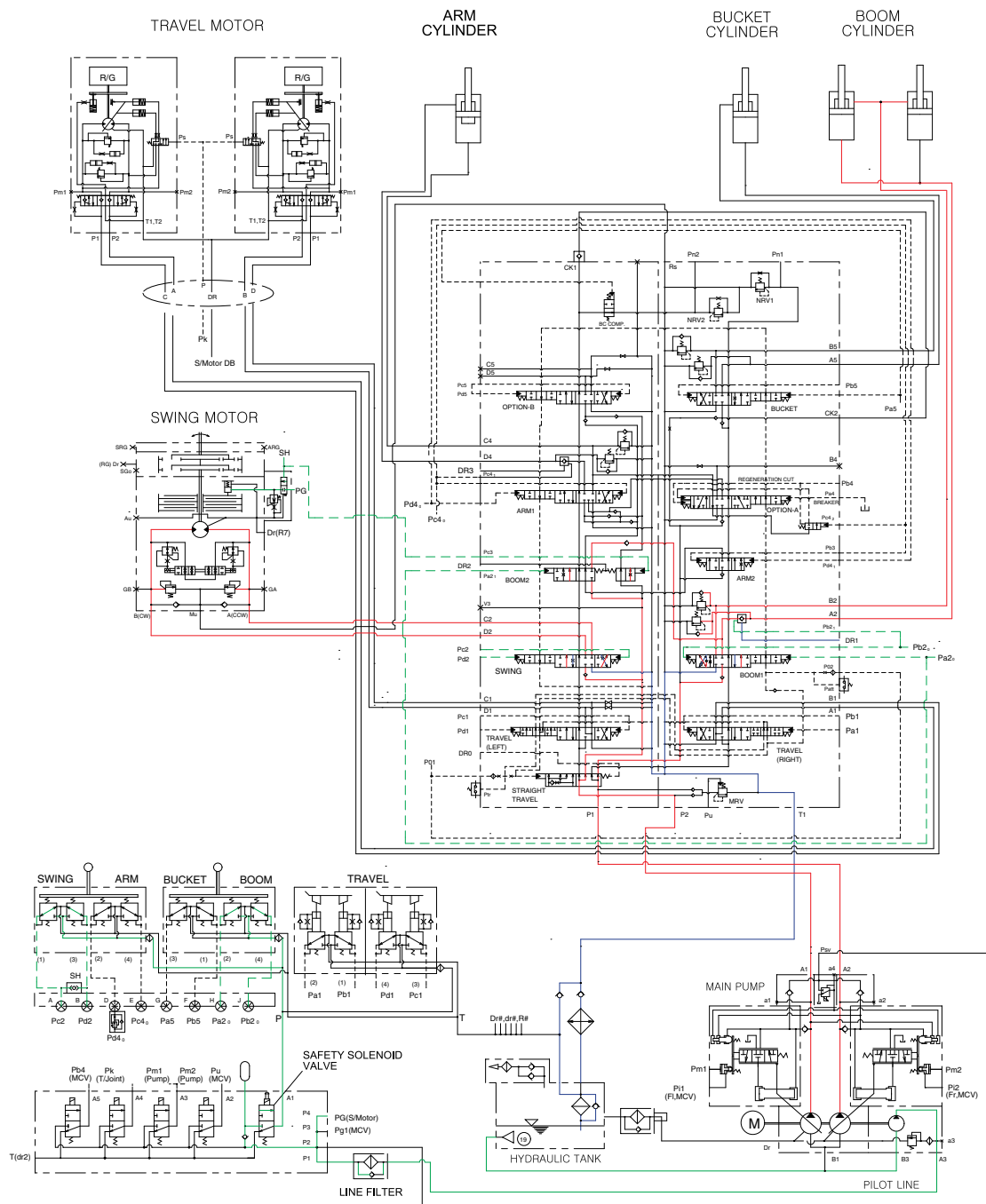

D22073HS18

When the swing and boom functions are operated, simultaneously the swing spool and boom spools in the main control valve are moved to the functional position by the pilot oil pressure from the remote control valve.

The oil from the front pump flows into the swing motor through swing spool and the boom cylinder through boom 2 spool.

The oil from the rear pump flows into the boom cylinders through the boom 1 spool in the right control valve.

The superstructure swings and the boom is operated.

3. COMBINED SWING AND ARM OPERATION

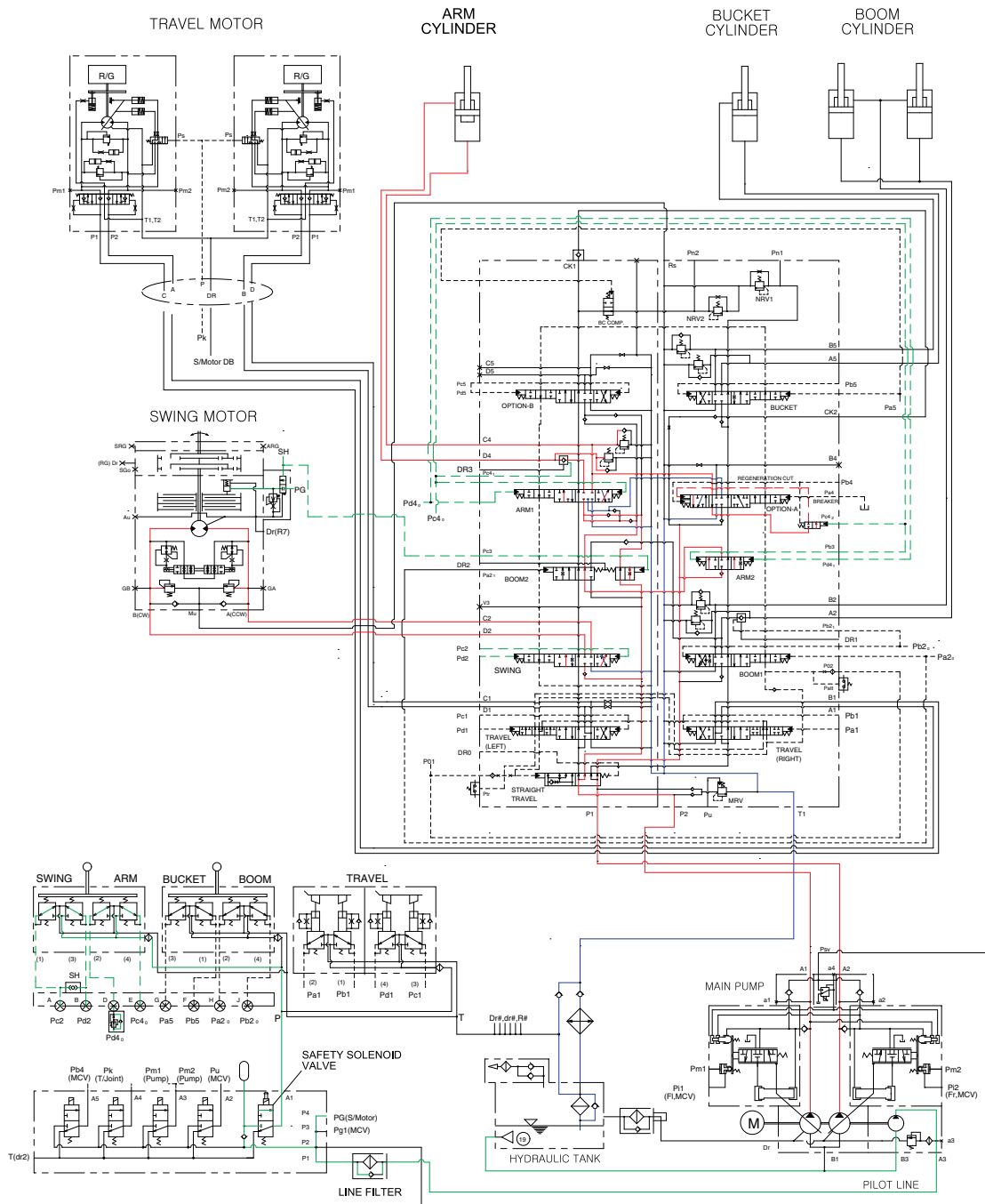

D22073HS19

When the swing and arm functions are operated, simultaneously the swing spool and arm spools in the main control valve are moved to the functional position by the pilot oil pressure from the remote control valve.

The oil from the front pump flows into the swing motor through swing spool and the arm cylinder through arm 1 spool.

The oil from the rear pump flows into the arm cylinder through the arm 2 spool of the right control valve.

The superstructure swings and the arm is operated.

4. COMBINED SWING AND BUCKET OPERATION

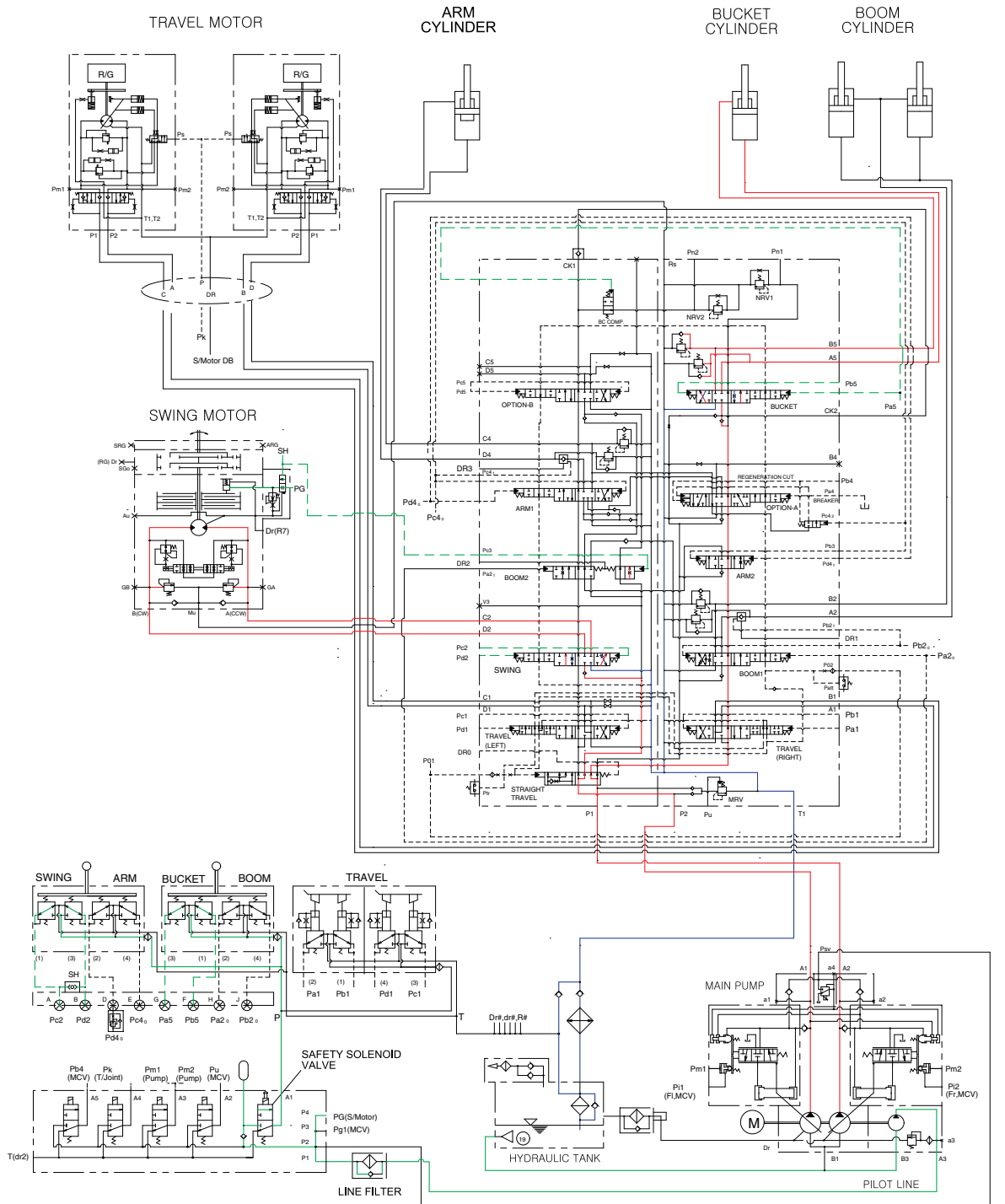

D22073HS20

When the swing and bucket functions are operated, simultaneously the swing spool and bucket spool in the main control valve are moved to the functional position by the pilot oil pressure from the remote control valve.

The oil from the front pump flows into the swing motor through the swing spool in the left control valve.

The oil from the rear pump flows into the bucket cylinder through the bucket spool in the right control valve.

5. COMBINED SWING, BOOM, ARM AND BUCKET OPERATION

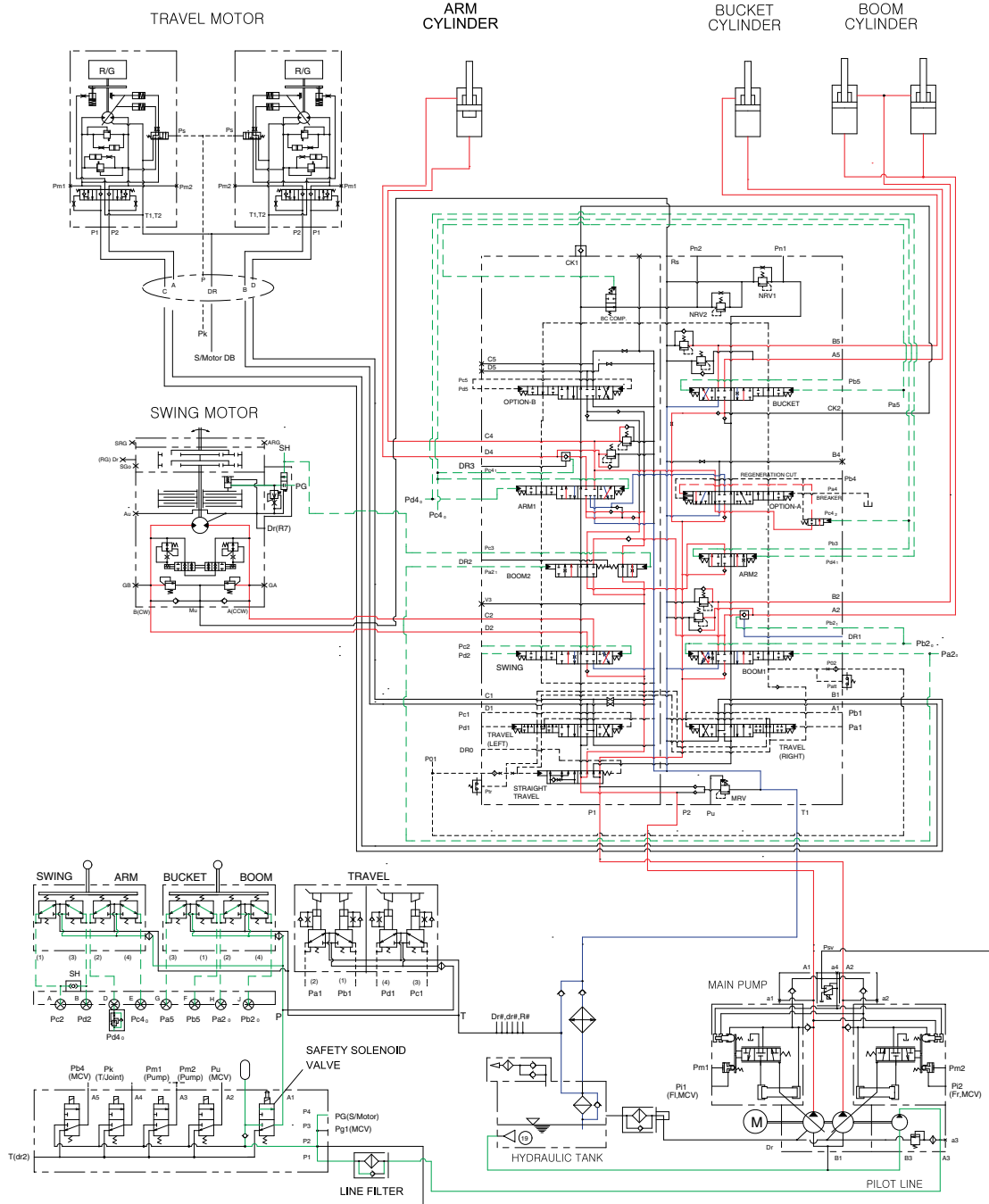

D22073HS21

When the swing, boom, arm and bucket functions are operated, simultaneously each spool in the main control valve is moved to the functional position by the pilot oil pressure from the remote control valve.

The oil from the front pump flows into the swing motor, boom cylinders and arm cylinder through the swing spool, boom 2 spool, arm 1 spool, and the parallel and confluence oil passage in the left control valve. The oil from the rear pump flows into the boom cylinders, arm cylinder and bucket cylinder through the boom 1 spool, arm 2 spool, bucket spool and the parallel and confluence oil passage in the right control valve.

The superstructure swings and the boom, arm and bucket are operated.

6. COMBINED SWING AND TRAVEL OPERATION

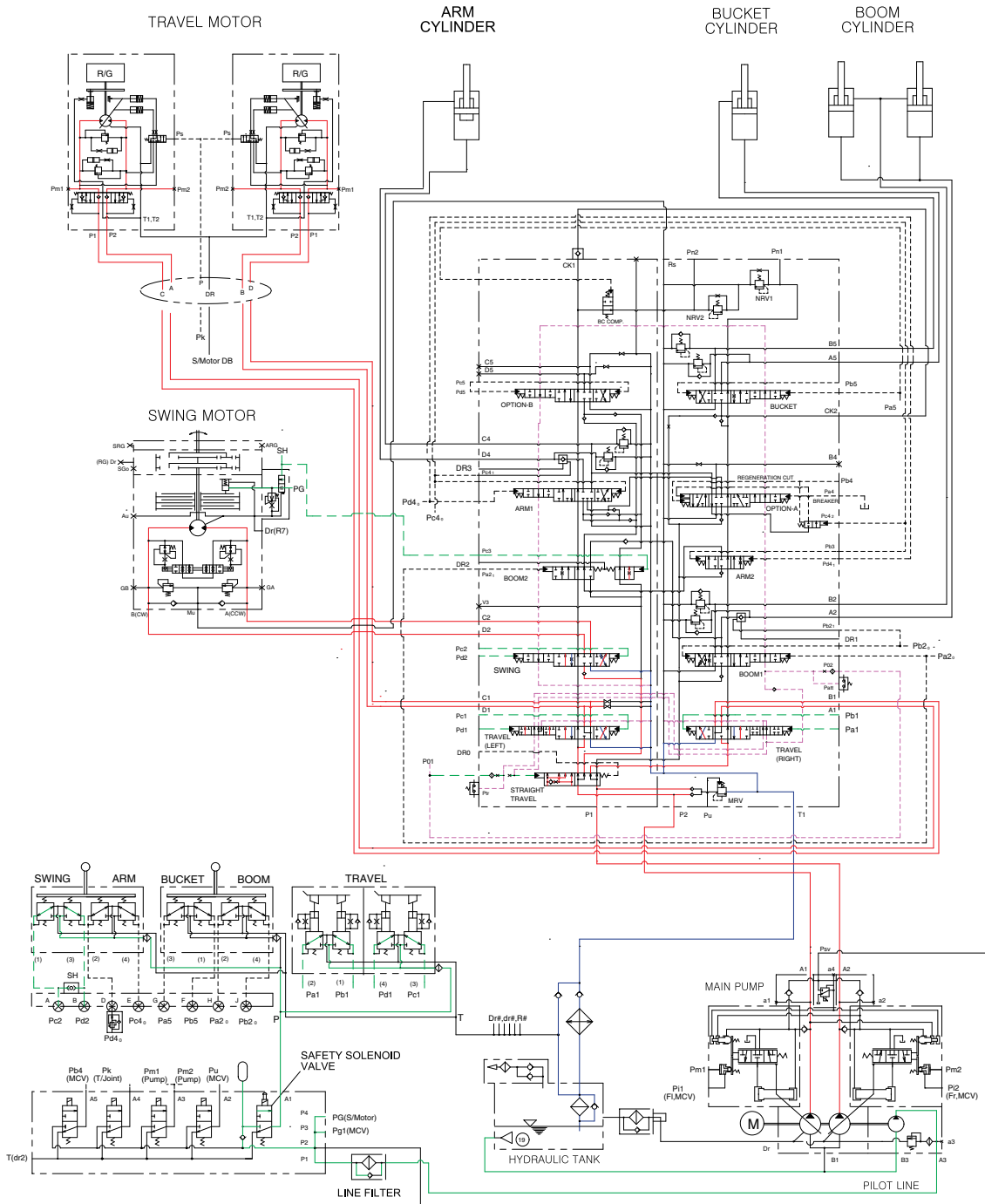

D22073HS22

When the swing and travel functions are operated, simultaneously the swing spool and travel spools in the main control valve are moved to the functional position by the pilot oil pressure from the remote control valve and straight travel spool is pushed to the left by the pilot oil pressure from the pilot pump.

The oil from the front pump flows into the swing motor through the swing spool. The oil from the rear pump flows into the travel motor through the RH travel spool of the right control valve and the LH travel spool of the left control valve via the straight travel spool.

The superstructure swings and the machine travels straight.

7. COMBINED BOOM AND TRAVEL OPERATION

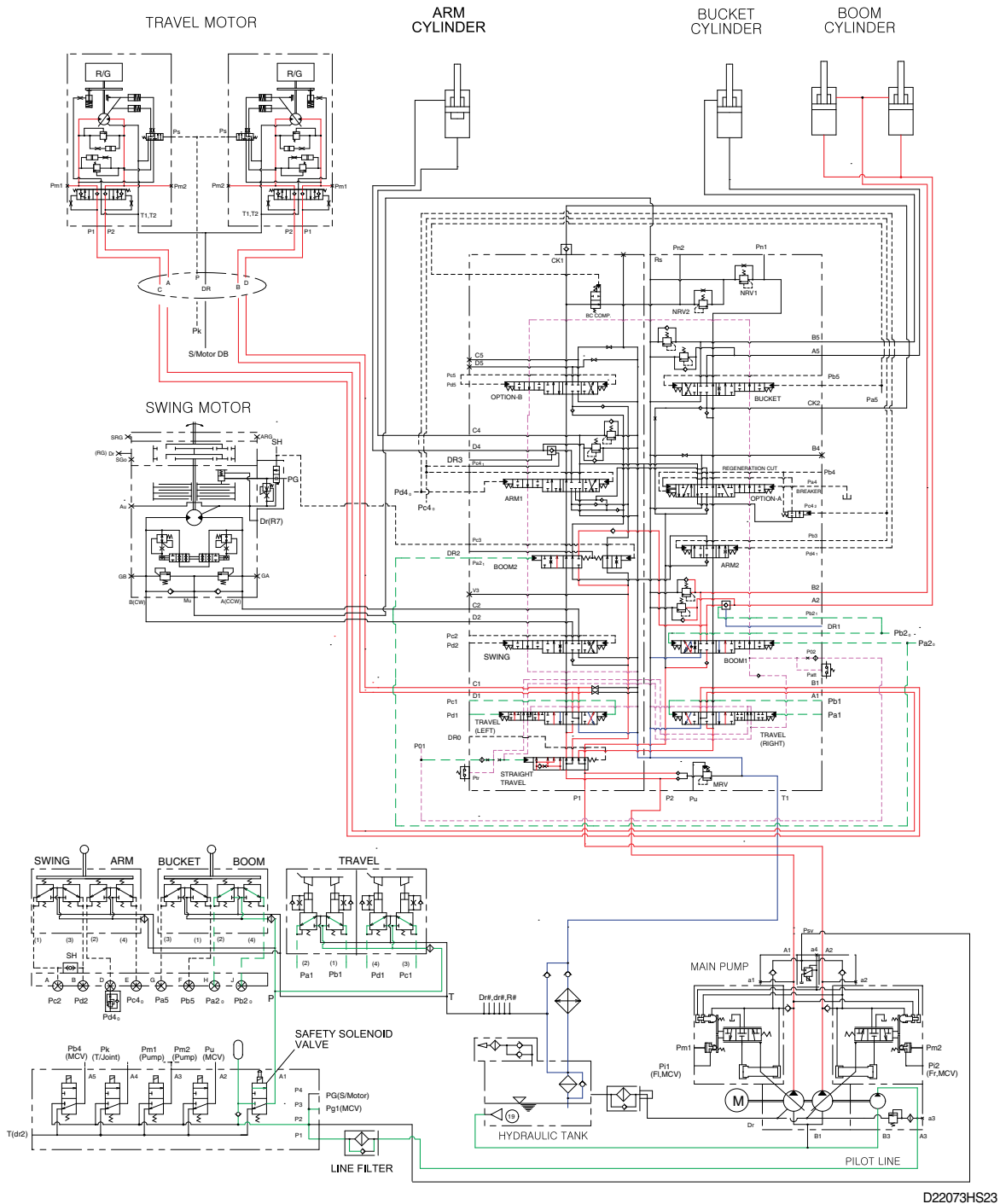

D22073HS23

When the boom and travel functions are operated, simultaneously the boom spools and travel spools in the main control valve are moved to the functional position by the pilot oil pressure from the remote control valve and the straight travel spool is pushed to the left by the oil pressure from pilot pump. The oil from the front pump flows into the boom cylinders through the boom 2 spool and boom 1 spool via the parallel and confluence oil passage in case boom up operation. The oil from the rear pump flows into the travel motors through the RH travel spool of the right control valve and the LH travel spool of the left control valve via the straight travel spool.

8. COMBINED ARM AND TRAVEL OPERATION

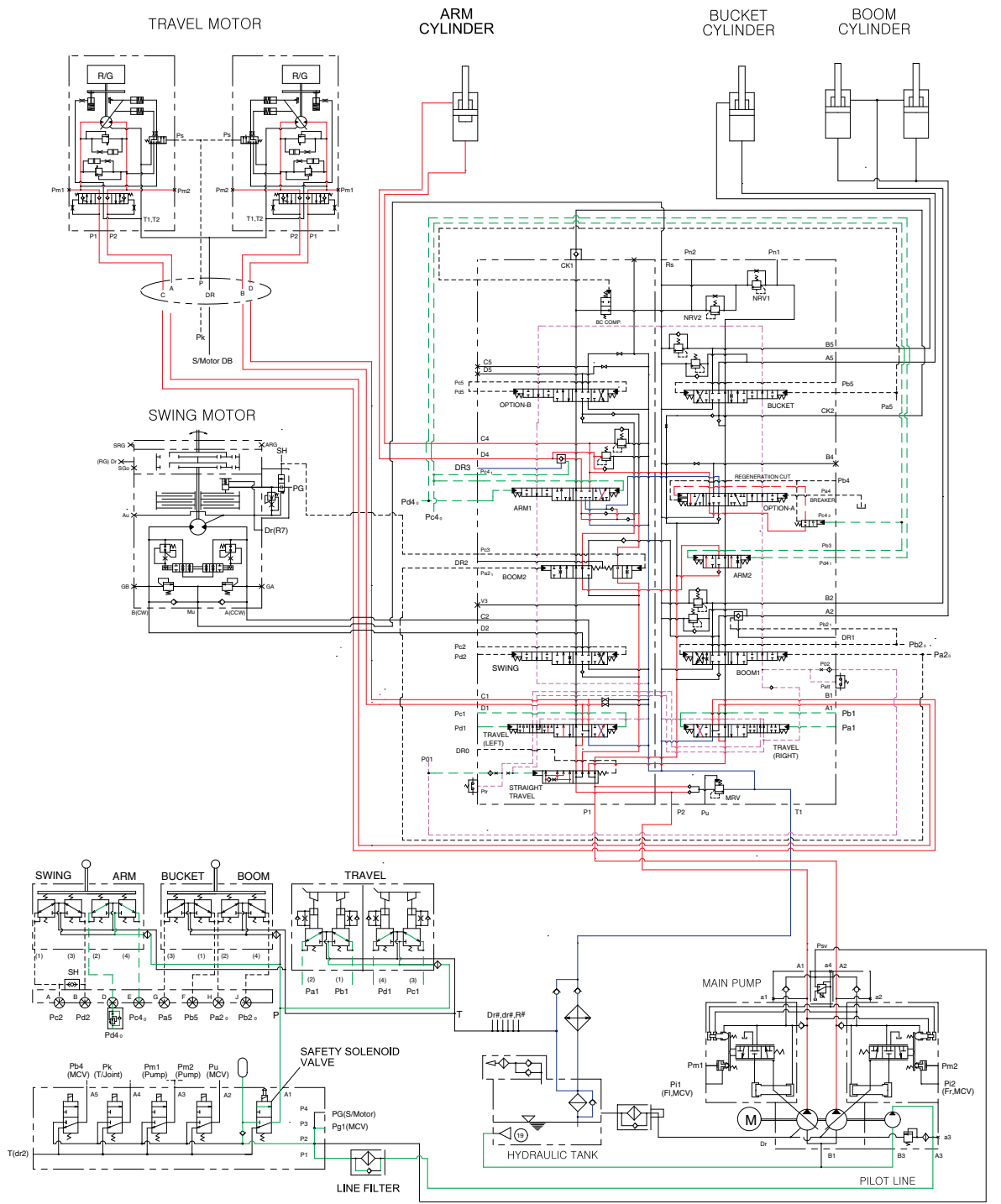

D22073HS24

When the arm and travel functions are operated, simultaneously the arm spools and travel spools in the main control valve are moved to the functional position by the pilot oil pressure from the remote control valve and the straight travel spool is pushed to the left by the oil pressure from pilot pump.

The oil from the front pump flows into the arm cylinders through the arm 1 spool and arm 2 spool via the parallel and confluence oil passage. The oil from the rear pump flows into the travel motors through the RH travel spool of the right control valve and the LH travel spool of the left control valve via the straight travel spool.

The arm is operated and the machine travels straight.

9. COMBINED BUCKET AND TRAVEL OPERATION

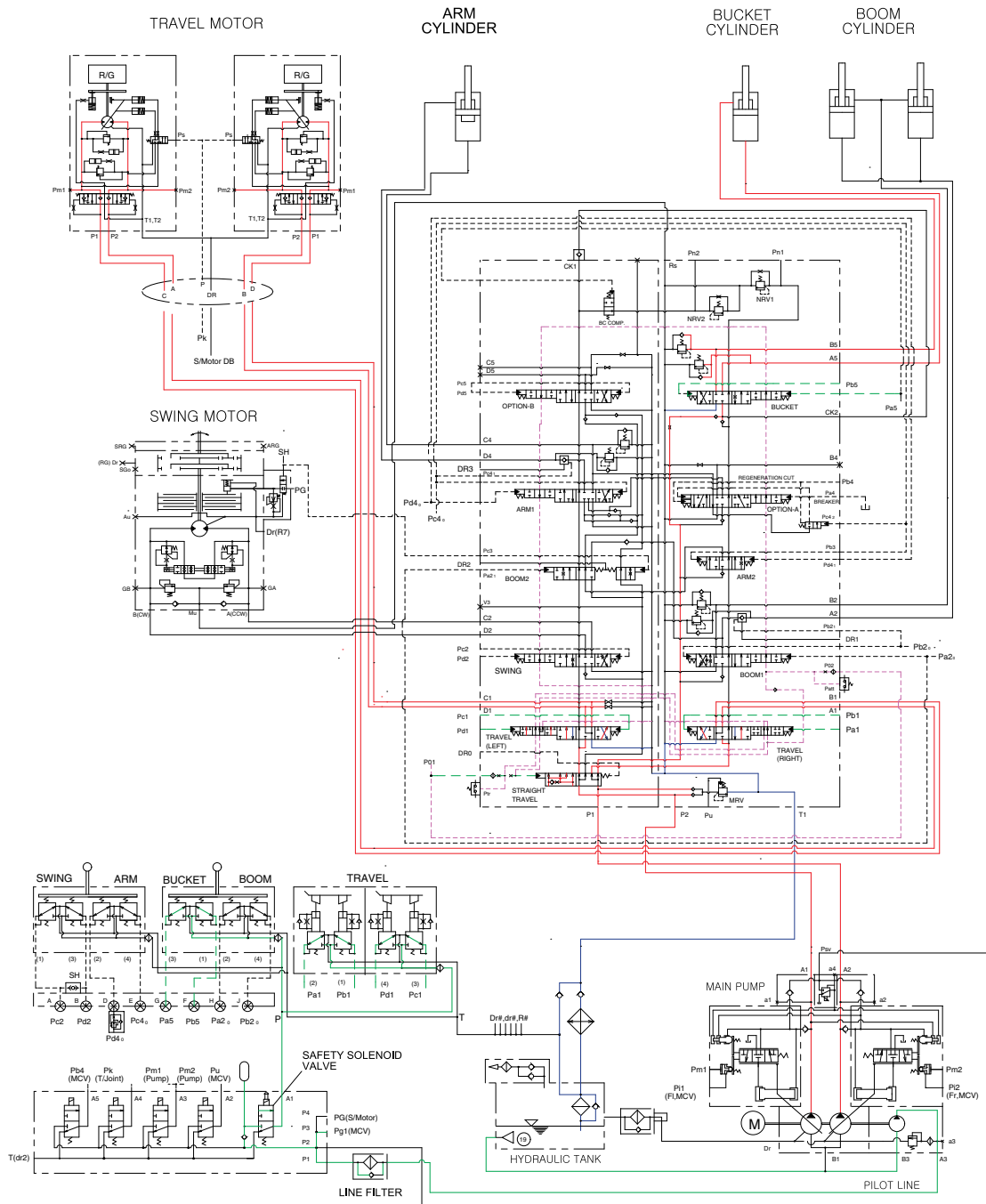

D22073HS25

When the bucket and travel functions are operated, simultaneously the bucket spool and travel spools in the main control valve are moved to the functional position by the pilot oil pressure from the remote control valve, and the straight travel spool is pushed to the left by the oil pressure from pilot pump. The oil from the front pump flows into the bucket cylinder through the bucket spool via the confluence oil passage. The oil from the rear pump flows into the travel motors through the RH travel spool of the right control valve and the LH travel spool of the left control valve via the straight travel spool of the control valve.

The bucket is operated and the machine travels straight.