

GROUP 4 POWER BOOST SYSTEM

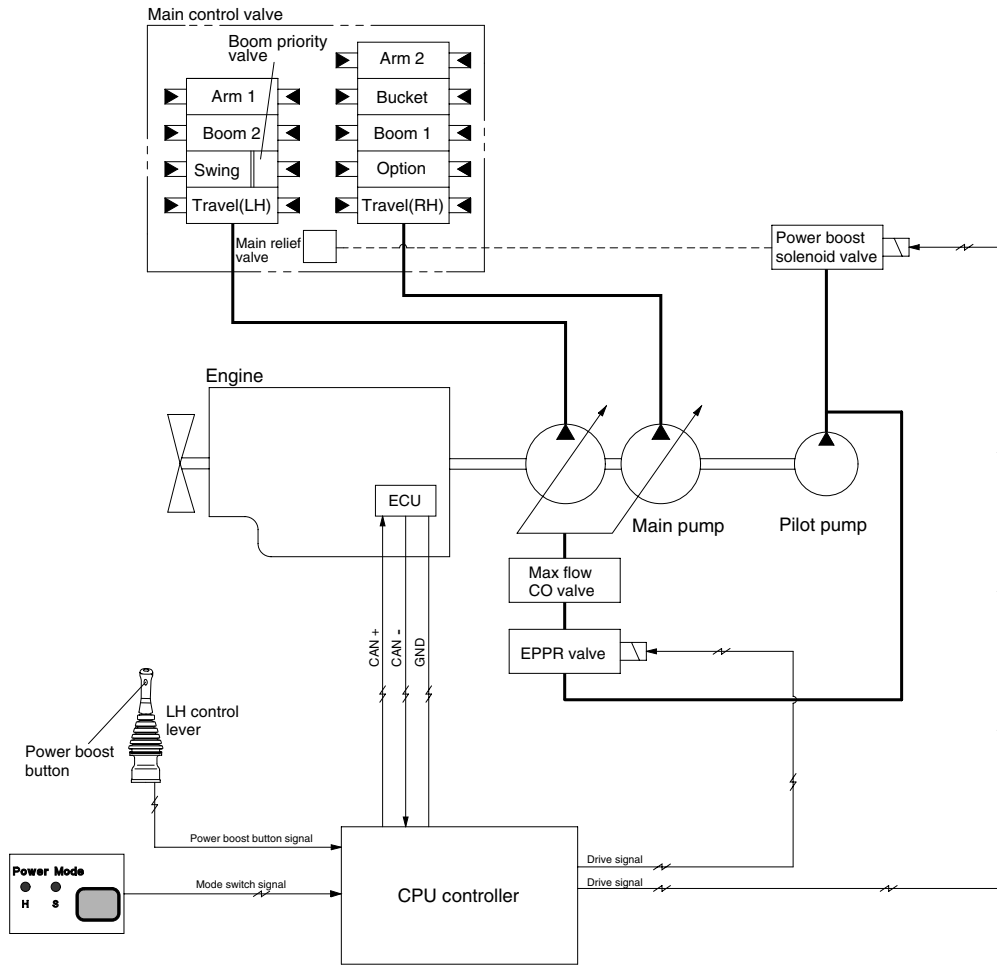

2107A5MS06

- When the power boost switch on the left control lever knob is pushed ON, the maximum digging power is increased by 10%.
- When the power set is at M, H or S and the power boost function is activated, the power boost solenoid valve pilot pressure raises the set pressure of the main relief valve to increase the digging power.

Description	Power boost switch	
	OFF	ON
Power set	H or S	H
	M	M
Main relief valve set pressure	330kgf/cm ²	360kgf/cm ²
Time of operation	-	Even when pressed continuously, it is canceled after 8 sec.

※ Default - Power boost solenoid valve : OFF