

GROUP 3 ELECTRIC SYSTEM

ELECTRIC COMPONENTS MOUNTING 1

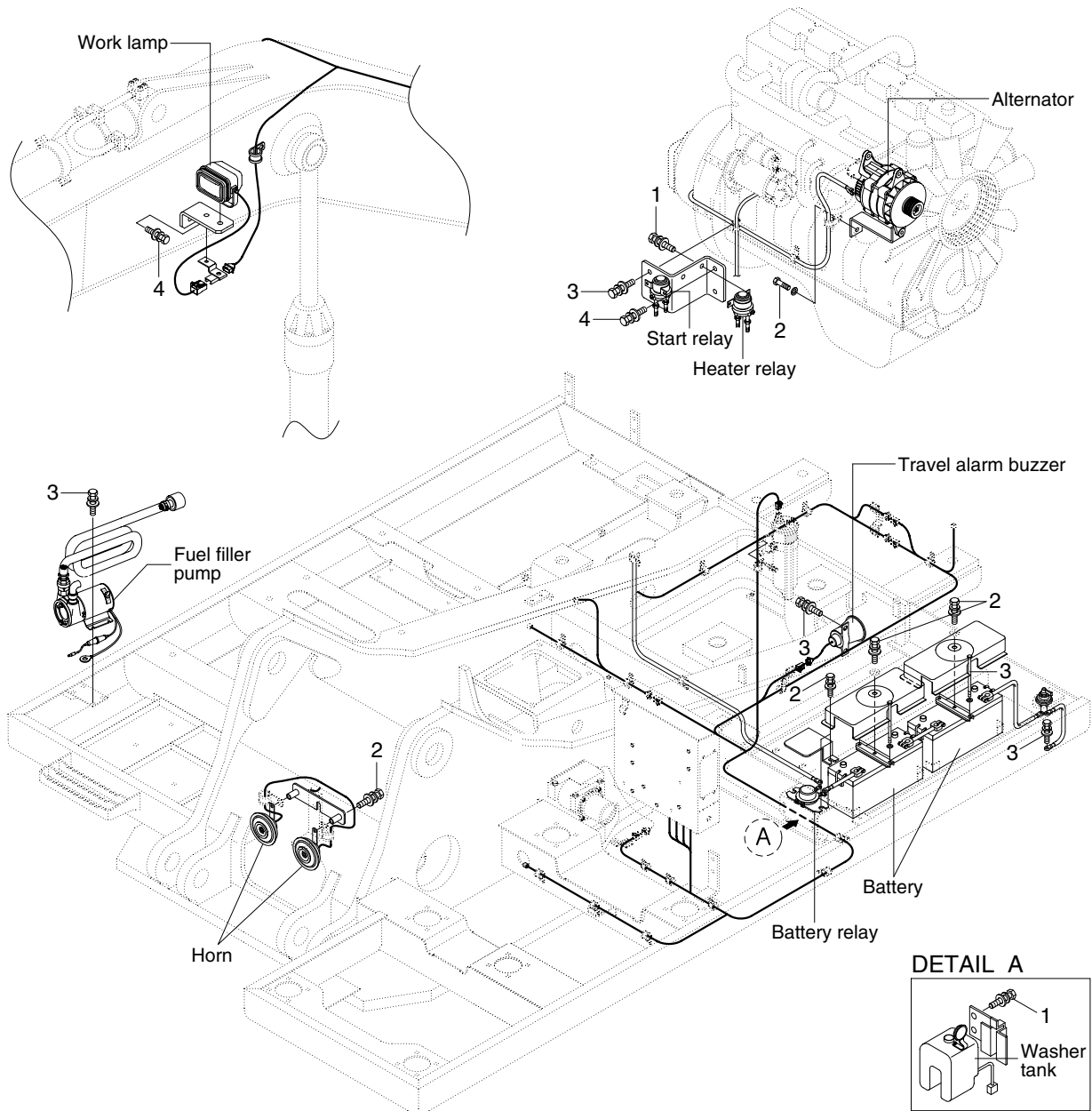

29079CM03

· Tightening torque

Item	Size	kgf · m	lbf · ft
1	M 6×1.0	1.05±0.2	7.6±1.45
2	M 8×1.25	2.5±0.5	18.1±3.6

Item	Size	kgf · m	lbf · ft
3	M10×1.5	6.9±1.4	49.9±10.1
4	M12×1.75	12.8±3.0	92.6±21.7

ELECTRIC COMPONENTS MOUNTING 2

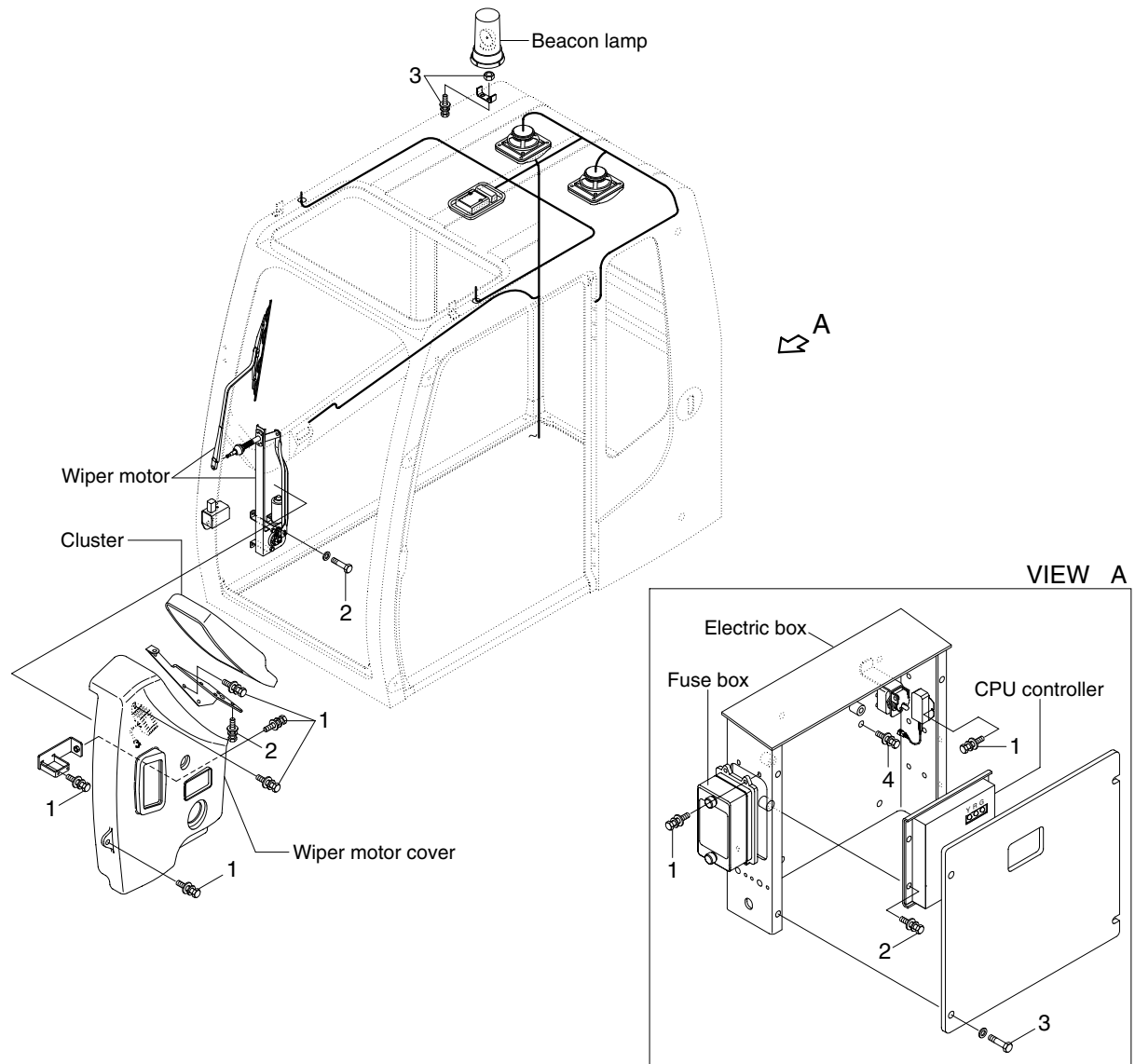

29079CM04

· Tightening torque

Item	Size	kgf · m	lbf · ft
1	M 6×1.0	1.05±0.2	7.6±1.45
2	M 8×1.25	2.5±0.5	18.1±3.6

Item	Size	kgf · m	lbf · ft
3	M10×1.5	6.9±1.4	49.9±10.1
-	-	-	-