

GROUP 5 COMBINED OPERATION

1. OUTLINE

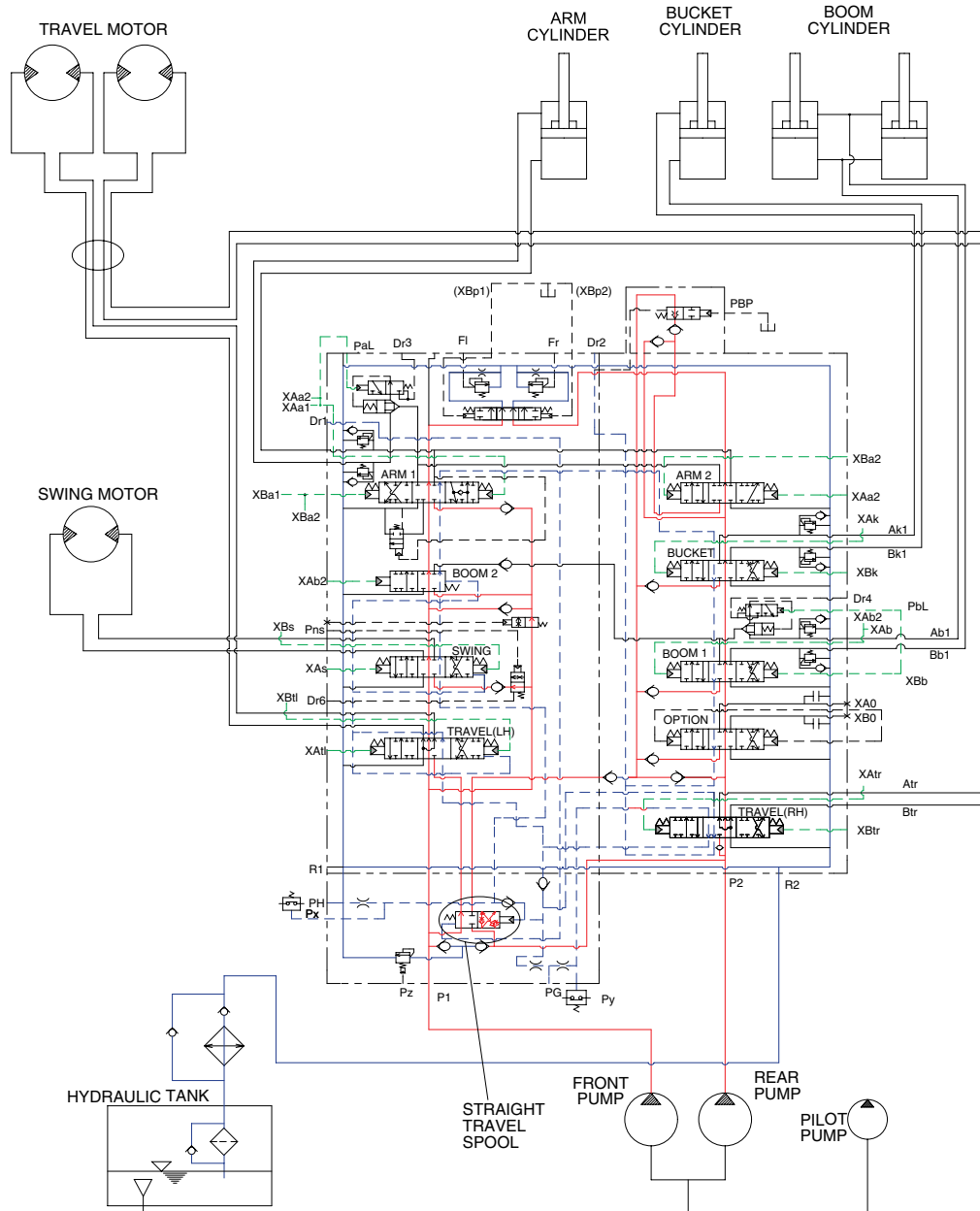

21073HS17

The oil from the front and rear pump flows through the neutral oil passage, bypass oil passage and confluence oil passage in the main control valve. Then the oil goes to each actuator and operates them. Check valves and orifices are located on these oil passage in the main control valve. These control the oil from the main pumps so as to correspond to the operation of each actuator and smooth the combined operation.

STRAIGHT TRAVEL SPOOL

This straight travel spool for straight travel is provided in the main control valve.

If any actuator is operated when traveling, the straight travel spool is pushed to the left by the pilot oil pressure.

Consequently, the left and right travel oil supply passage are connected, and equivalent amount of oil flows into the left and right travel motors. This keeps the straight travel.

2. COMBINED SWING AND BOOM OPERATION

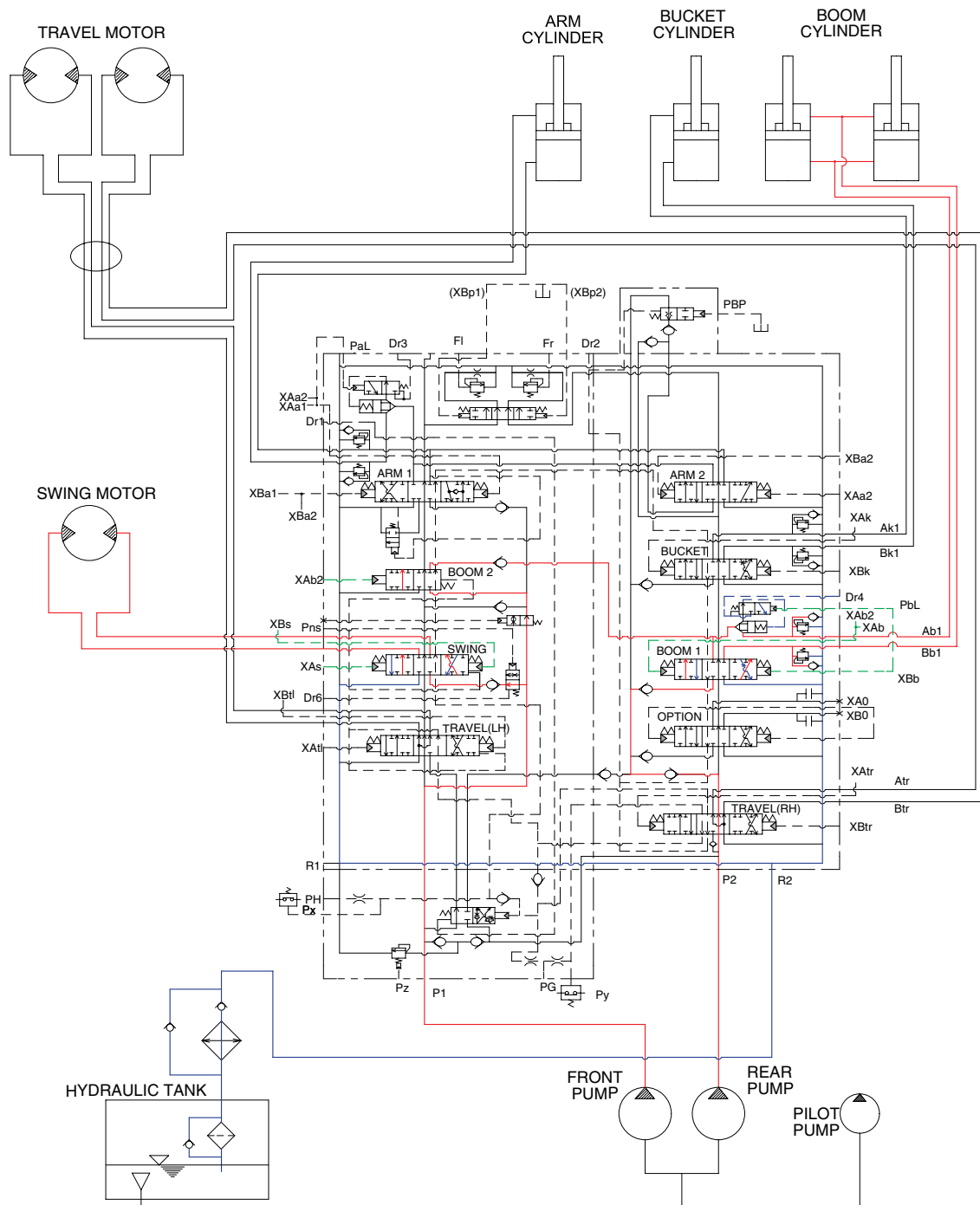

21073HS18

When the swing and boom functions are operated, simultaneously the swing spool and boom spools in the main control valve are moved to the functional position by the pilot oil pressure from the remote control valve.

The oil from the front pump flows into the swing motor through swing spool and the boom cylinder through boom 2 spool.

The oil from the rear pump flows into the boom cylinders through the boom 1 spool in the right control valve.

The superstructure swings and the boom is operated.

3. COMBINED SWING AND ARM OPERATION

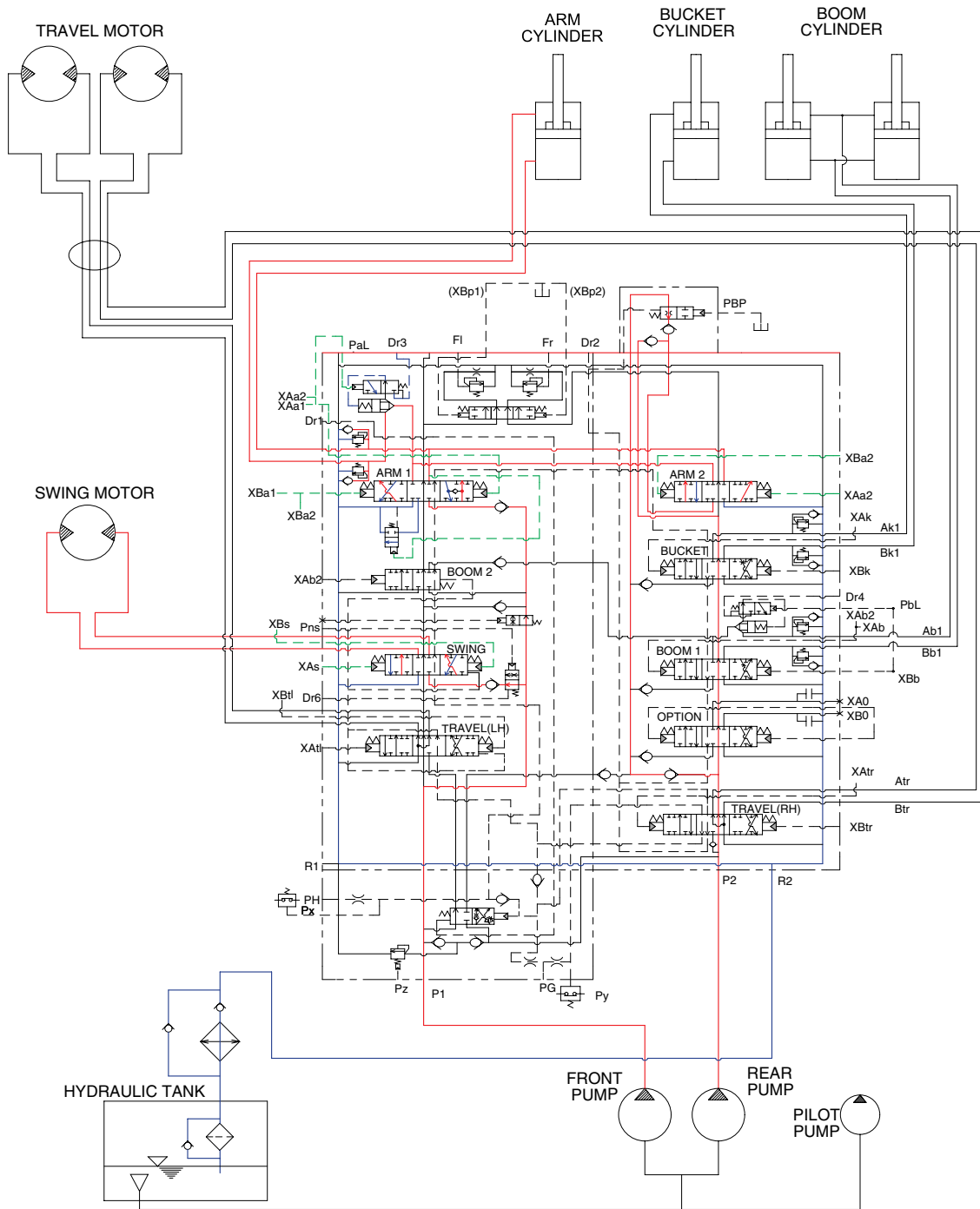

21073HS19

When the swing and arm functions are operated, simultaneously the swing spool and arm spools in the main control valve are moved to the functional position by the pilot oil pressure from the remote control valve.

The oil from the front pump flows into the swing motor through swing spool and the arm cylinder through arm 1 spool.

The oil from the rear pump flows into the arm cylinder through the arm 2 spool of the right control valve.

The superstructure swings and the arm is operated.

4. COMBINED SWING AND BUCKET OPERATION

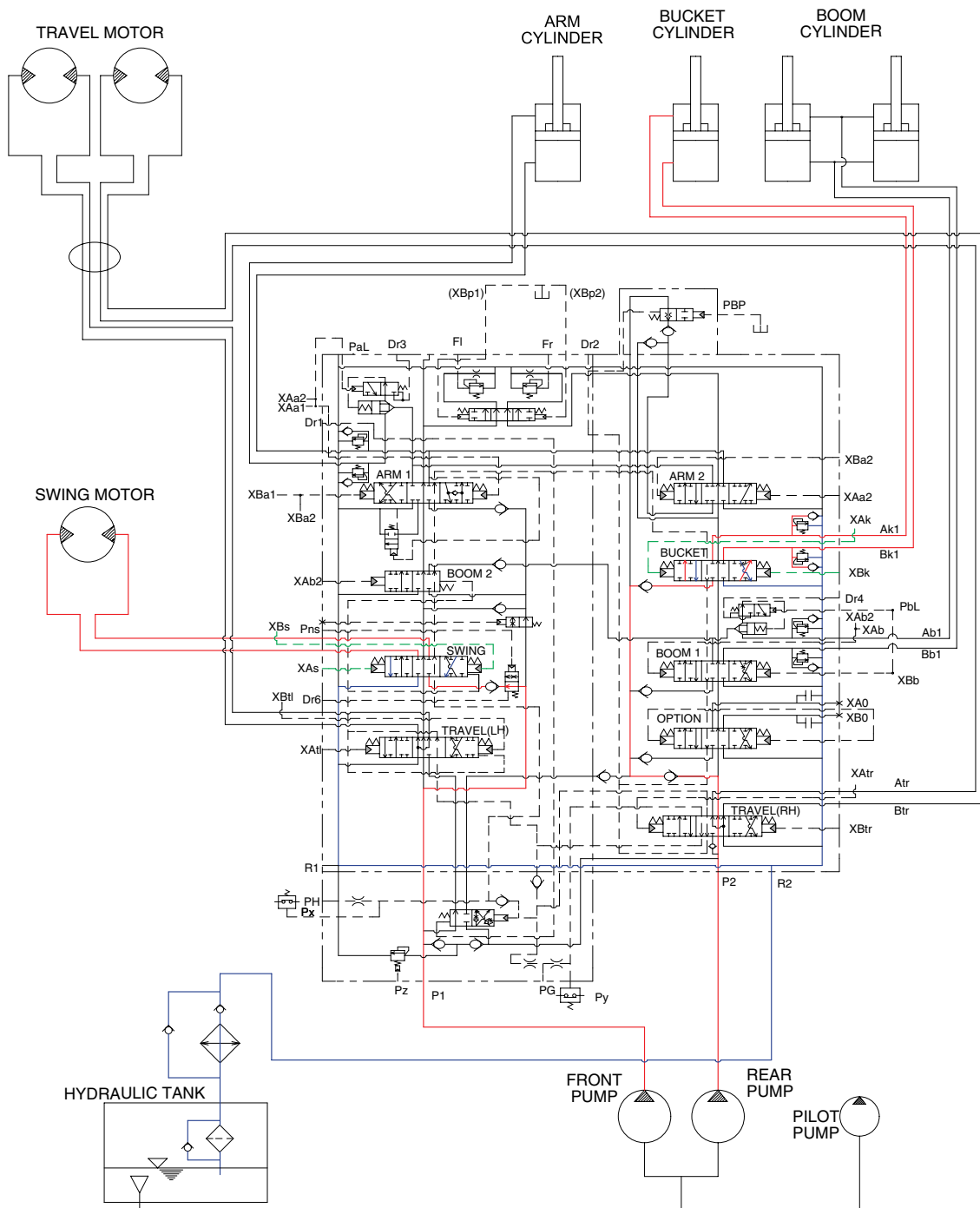

21073HS20

When the swing and bucket functions are operated, simultaneously the swing spool and bucket spool in the main control valve are moved to the functional position by the pilot oil pressure from the remote control valve.

The oil from the front pump flows into the swing motor through the swing spool in the left control valve.

The oil from the rear pump flows into the bucket cylinder through the bucket spool in the right control valve.

5. COMBINED SWING, BOOM, ARM AND BUCKET OPERATION

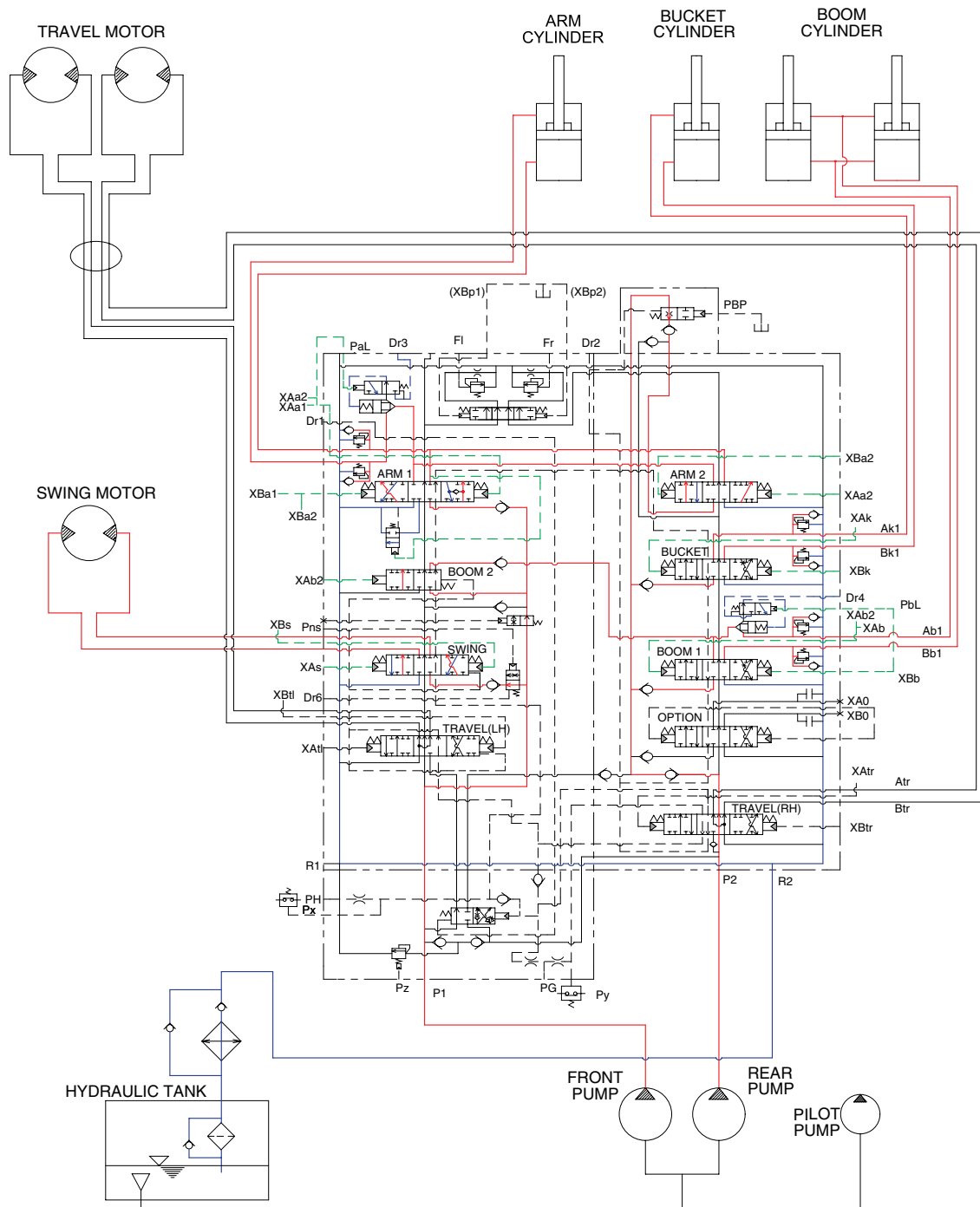

21073HS21

When the swing, boom, arm and bucket functions are operated, simultaneously each spool in the main control valve is moved to the functional position by the pilot oil pressure from the remote control valve.

The oil from the front pump flows into the swing motor, boom cylinders and arm cylinder through the swing spool, boom 2 spool, arm 1 spool, and the parallel and confluence oil passage in the left control valve. The oil from the rear pump flows into the boom cylinders, arm cylinder and bucket cylinder through the boom 1 spool, arm 2 spool, bucket spool and the parallel and confluence oil passage in the right control valve.

The superstructure swings and the boom, arm and bucket are operated.

6. COMBINED SWING AND TRAVEL OPERATION

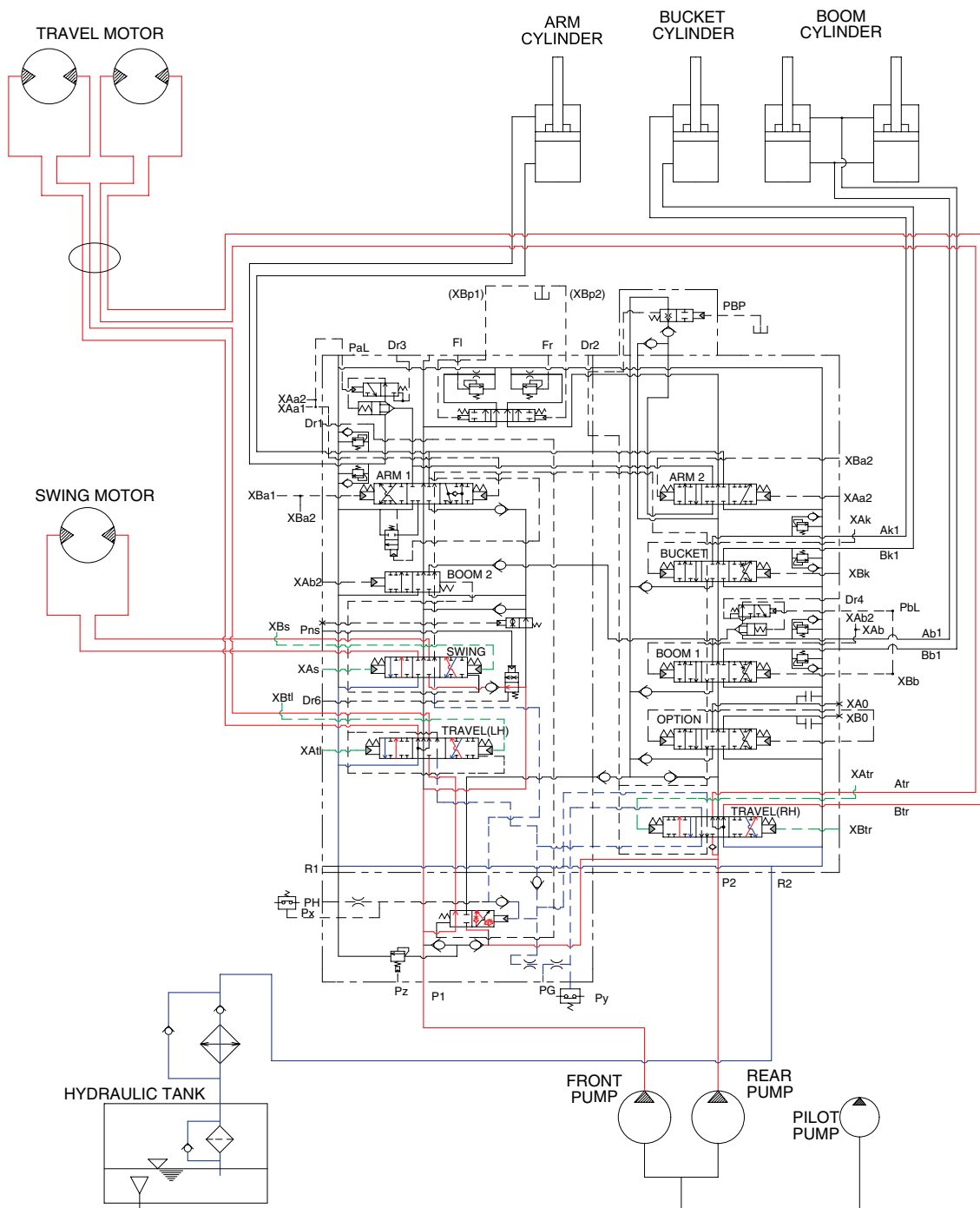

21073HS22

When the swing and travel functions are operated, simultaneously the swing spool and travel spools in the main control valve are moved to the functional position by the pilot oil pressure from the remote control valve and straight travel spool is pushed to the left by the pilot oil pressure from the pilot pump.

The oil from the front pump flows into the swing motor through the swing spool. The oil from the rear pump flows into the travel motor through the RH travel spool of the right control valve and the LH travel spool of the left control valve via the straight travel spool.

The superstructure swings and the machine travels straight.

7. COMBINED BOOM AND TRAVEL OPERATION

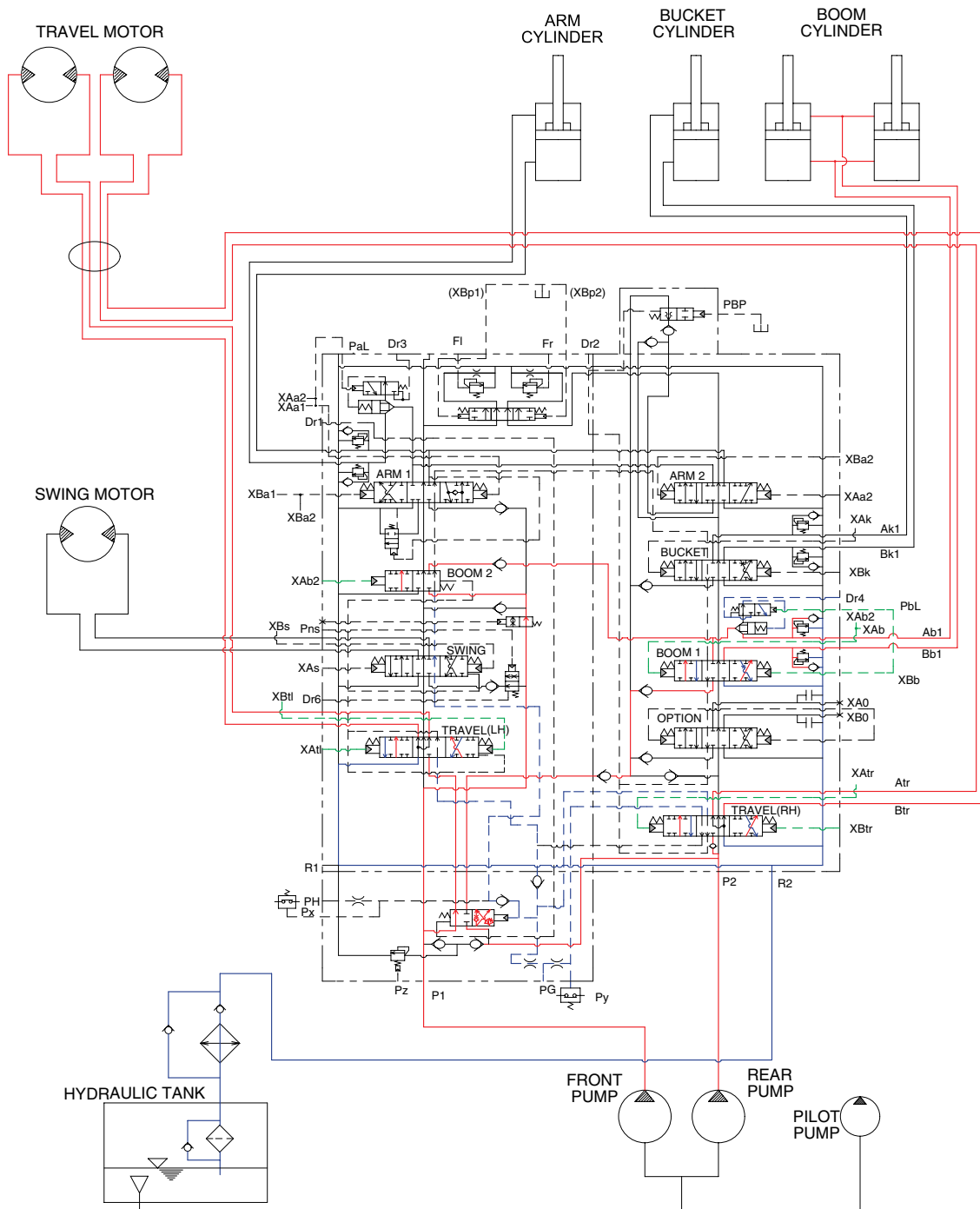

21073HS23

When the boom and travel functions are operated, simultaneously the boom spools and travel spools in the main control valve are moved to the functional position by the pilot oil pressure from the remote control valve and the straight travel spool is pushed to the left by the oil pressure from pilot pump. The oil from the front pump flows into the boom cylinders through the boom 2 spool and boom 1 spool via the parallel and confluence oil passage in case boom up operation. The oil from the rear pump flows into the travel motors through the RH travel spool of the right control valve and the LH travel spool of the left control valve via the straight travel spool.

8. COMBINED ARM AND TRAVEL OPERATION

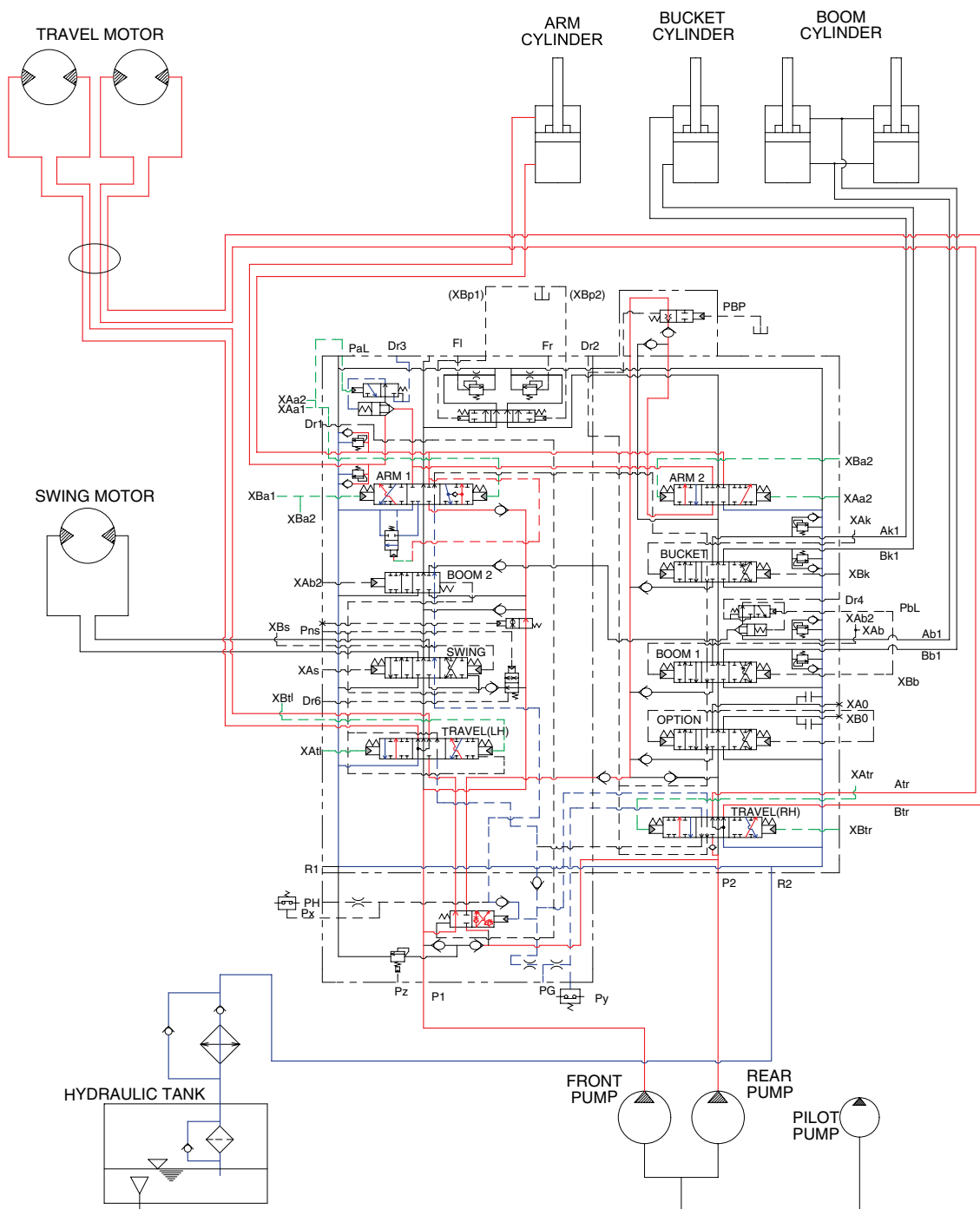

21073HS24

When the arm and travel functions are operated, simultaneously the arm spools and travel spools in the main control valve are moved to the functional position by the pilot oil pressure from the remote control valve and the straight travel spool is pushed to the left by the oil pressure from pilot pump. The oil from the front pump flows into the arm cylinders through the arm 1 spool and arm 2 spool via the parallel and confluence oil passage. The oil from the rear pump flows into the travel motors through the RH travel spool of the right control valve and the LH travel spool of the left control valve via the straight travel spool. The arm is operated and the machine travels straight.

9. COMBINED BUCKET AND TRAVEL OPERATION

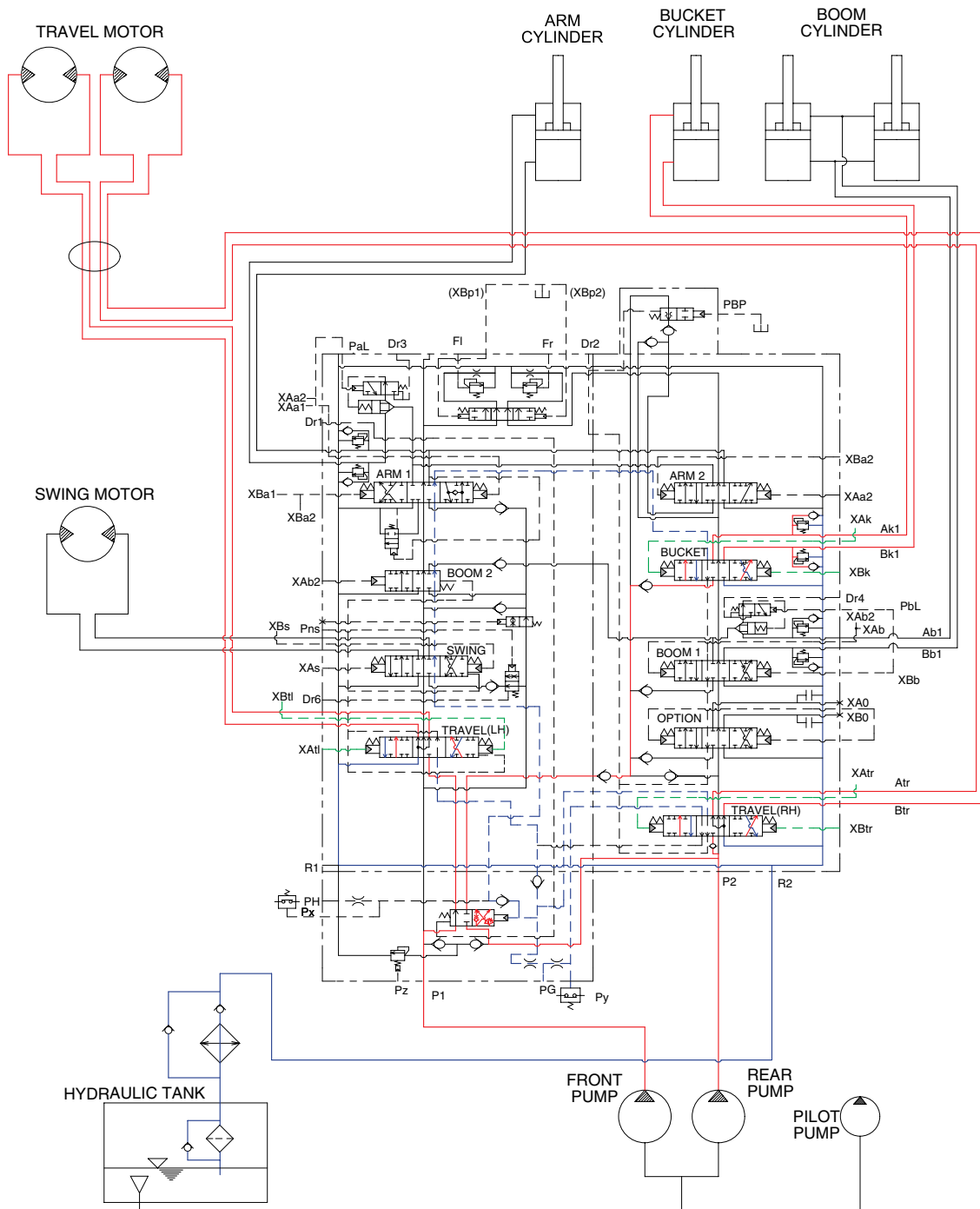

21073HS02

When the bucket and travel functions are operated, simultaneously the bucket spool and travel spools in the main control valve are moved to the functional position by the pilot oil pressure from the remote control valve, and the straight travel spool is pushed to the left by the oil pressure from pilot pump. The oil from the front pump flows into the bucket cylinder through the bucket spool via the confluence oil passage. The oil from the rear pump flows into the travel motors through the RH travel spool of the right control valve and the LH travel spool of the left control valve via the straight travel spool of the control valve.

The bucket is operated and the machine travels straight.