

GROUP 11 EPPR VALVE

1. COMPOSITION OF EPPR VALVE

EPPR(Electro Proportional Pressure Reducing) valve consists of electro magnet and spool valve installed at main hydraulic pump.

1) ELECTRO MAGNET VALVE

Receive electric current from CPU controller and move the spool proportionally according to the specific amount of electric current value.

2) SPOOL VALVE

Is the two way direction control valve for pilot pressure to reduce hydraulic pump flow.

When the electro magnet valve is activated, pilot pressure enters into flow regulator of hydraulic pump. So, pump flow decreases to prevent engine stall.

3) PRESSURE AND ELECTRIC CURRENT VALUE FOR EACH MODE

Mode			Pressure		Electric current (mA)	Engine rpm (At accel dial 10)
			kgf/cm ²	psi		
Tier-I	Standard (Ver : 1.x)	H	0 ± 3	0 ± 40	160 ± 30	2250 ± 50
		S	13 ± 3	190 ± 40	370 ± 30	2150 ± 50
	Option (Ver : 2.x)	H	18 ± 3	260 ± 40	430 ± 30	2250 ± 50
		S	22 ± 3	320 ± 40	480 ± 30	2150 ± 50
Tier-II	Standard (Ver : 5.x)	H	2.5 ± 3	40 ± 40	190 ± 30	2150 ± 50
		S	8 ± 3	120 ± 40	290 ± 30	2050 ± 50
	Option (Ver : 6.x)	H	4 ± 3	60 ± 40	220 ± 30	2050 ± 50
		S	6 ± 3	90 ± 40	260 ± 30	1950 ± 50
			19 ± 3	275 ± 40	440 ± 30	-



Manually operated condition when prolix switch is selected emergency position.

2. HOW TO SWITCH THE VERSION(1.x 2.x, or 5.x 6.x) ON THE CLUSTER

You can switch the EPPR valve pressure set by selecting the version(1.x 2.x, or 5.x 6.x).

Step 1. Turn the key switch **ON**.

Step 2. Press the **SELECT** switch 3 times.

Step 3. While 7 segment on the cluster shows the version of the CPU controller program, for example **21C1.4** press the buzzer stop switch() + travel speed control switch() at the same time for 2 seconds.

The display changes to **21C2.4**, and it indicates that version 2.4(Option) is selected.

If you want to get back to ver:1.x, go to step 1~3.

2. OPERATING PRINCIPLE

1) STRUCTURE

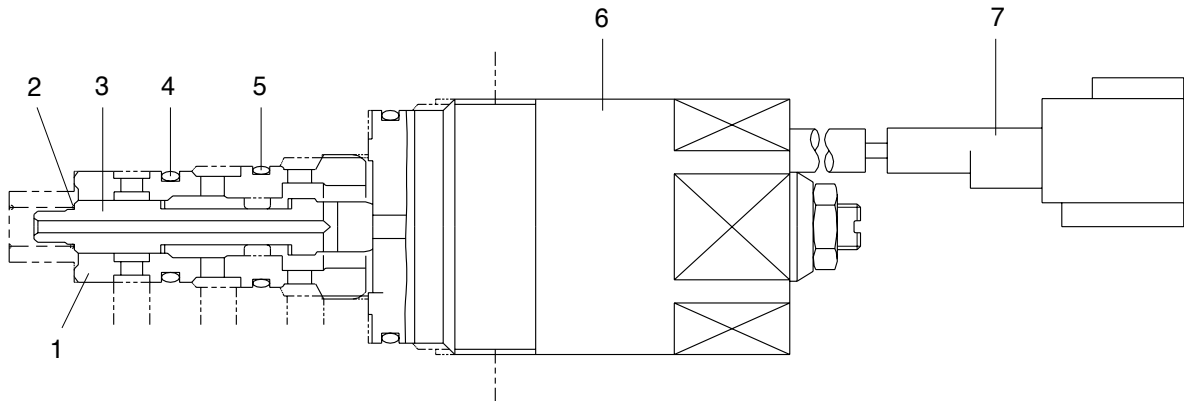

5-22(1) (290-7)

- 1 Sleeve
- 2 Spring
- 3 Spool

- 4 O-ring
- 5 O-ring

- 6 Solenoid valve
- 7 Connector

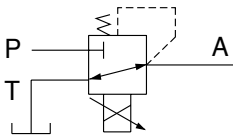

5-22A (290-7)

- P Pilot oil supply line(Pilot pressure)
- T Return to tank
- A Secondary pressure to flow regulator at hydraulic pump

2) AT H MODE

Pressure line is blocked and A oil returns to tank.

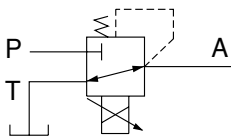

5-22B (290-7)

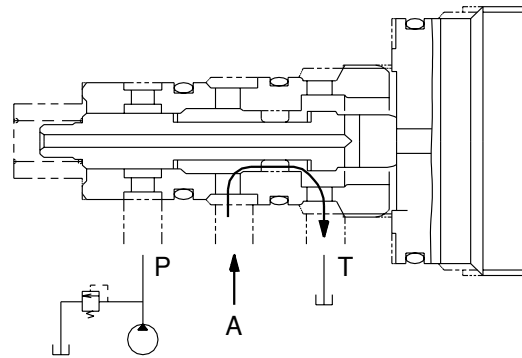

3) AT S MODE

Secondary pressure enters into A.

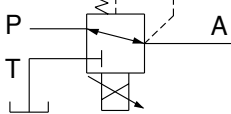

5-22C (290-7)

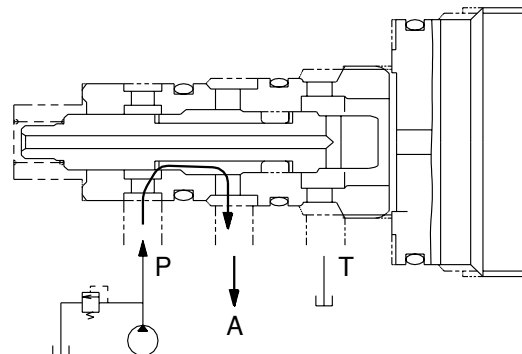

5-22(2) (290-7)

3. EPPR VALVE CHECK PROCEDURE

1) CHECK ELECTRIC VALUE AT EPPR VALVE

- (1) Start engine.
- (2) Set S-mode and cancel auto decel mode.
- (3) Position the accel dial at 10.
- (4) If tachometer show approx 2150 ± 50 rpm, 2050 ± 50 rpm(TIER II) disconnect one wire harness from EPPR valve.
- (5) Install multimeter as figure.
- (6) Check electric current at bucket circuit relief position.

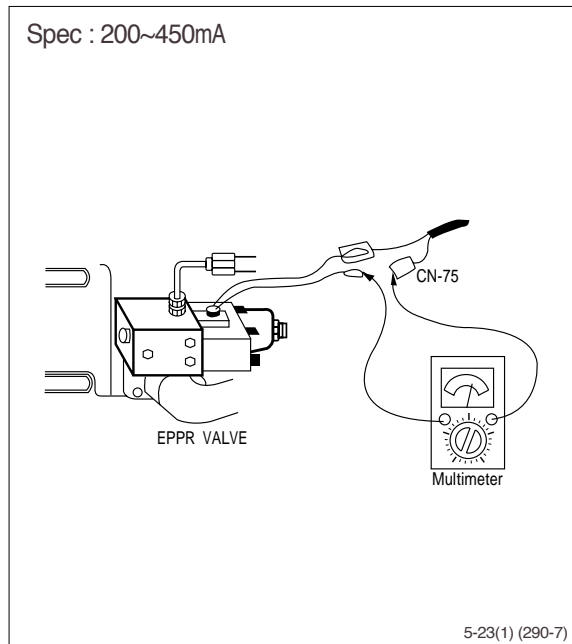

2) CHECK PRESSURE AT EPPR VALVE

- (1) Remove plug and connect pressure gauge as figure.
 - Gauge capacity : 0 to 40-50kgf/cm²
(0 to 580-725psi)
- (2) Start engine.
- (3) Set S-mode and cancel auto decel mode.
- (4) Position the accel dial at 10.
- (5) If tachometer show approx 2150 ± 50 rpm, 2050 ± 50 rpm(TIER II) check pressure at relief position of bucket circuit by operating bucket control lever.
- (6) If pressure is not correct, adjust it.
- (7) After adjust, test the machine.

