

GROUP 4 MAIN CONTROL VALVE

1. REMOVAL AND INSTALL OF MOTOR

1) REMOVAL

- (1) Lower the work equipment to the ground and stop the engine.
- (2) Operate the control levers and pedals several times to release the remaining pressure in the hydraulic piping.
- (3) Loosen the breather slowly to release the pressure inside the hydraulic tank.
- ▲ Escaping fluid under pressure can penetrate the skin causing serious injury.
- ※ When pipes and hoses are disconnected, the oil inside the piping will flow out, so catch it in oil pan.
- (4) Remove bolts and disconnect pipe.
- (5) Disconnect pilot line hoses.
- (6) Disconnect pilot piping.
- (7) Sling the control valve assembly and remove the control valve mounting bolt.
 - Weight : 200kg(441lb)
- (8) Remove the control valve assembly.
When removing the control valve assembly, check that all the piping have been disconnected.

2) INSTALL

- (1) Carry out installation in the reverse order to removal.
- (2) Bleed the air from below items.
 - ① Cylinder(Boom, arm, bucket)
 - ② Swing motor
 - ③ Travel motor
- ※ See each item removal and install.
- (3) Confirm the hydraulic oil level and recheck the hydraulic oil leak or not.

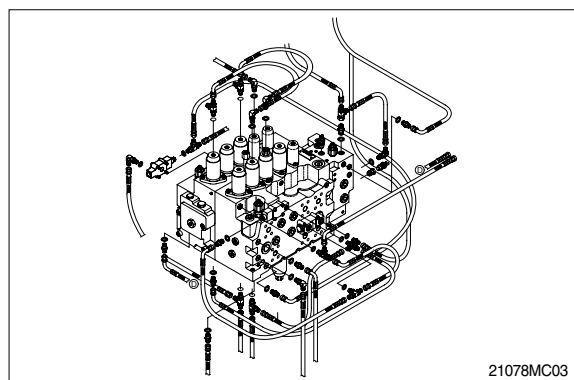
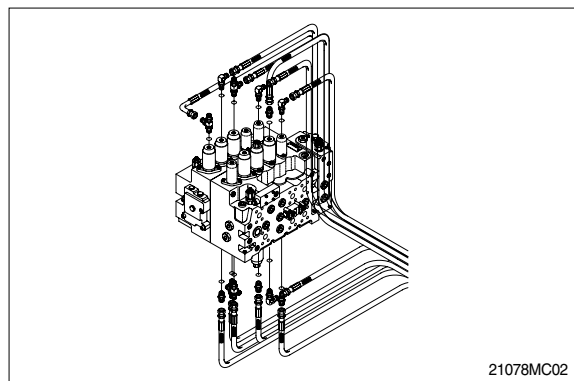
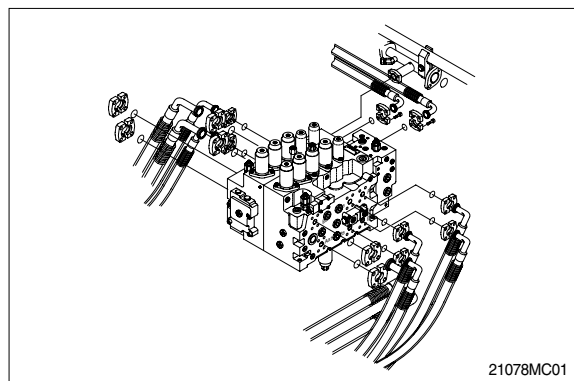

STRUCTURE(2/5)

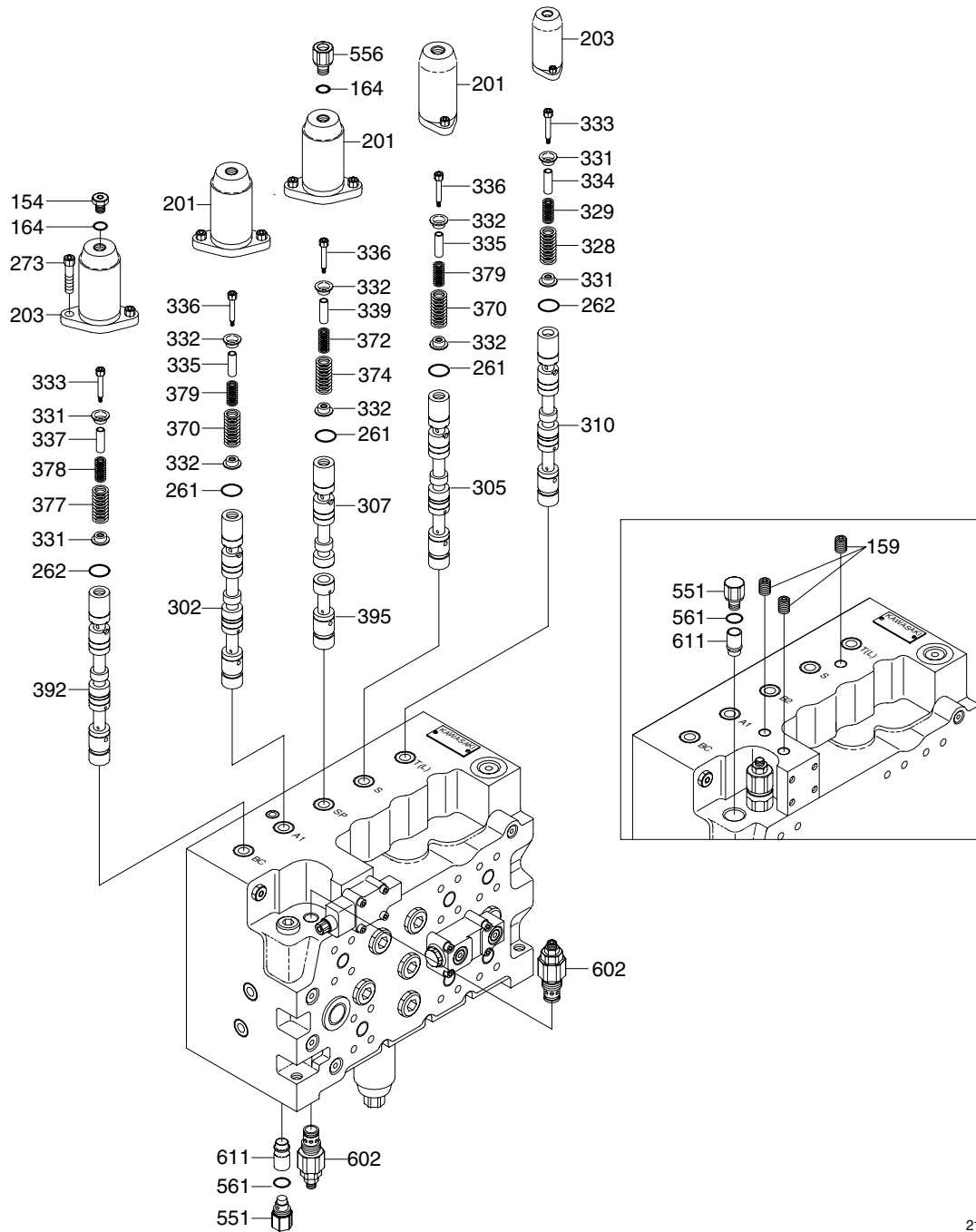

- | | | |
|------------------|------------------|---------------------------|
| 154 Plug | 310 Travel spool | 374 Spring |
| 159 Plug | 331 Seat | 377 Spring |
| 164 O-ring | 332 Seat | 378 Spring |
| 201 Cover | 333 Bolt | 379 Spring |
| 203 Cover | 334 Stopper | 392 By pass cut spool |
| 261 O-ring | 335 Stopper | 395 Spool |
| 262 O-ring | 336 Bolt | 551 Plug |
| 273 Socket screw | 337 Stopper | 556 Plug |
| 302 Arm1 spool | 339 Stopper | 561 O-ring |
| 305 Swing spool | 370 Spring | 602 Port relief valve |
| 307 Boom2 spool | 372 Spring | 611 Nega con relief valve |

21078MC05

STRUCTURE(3/5)

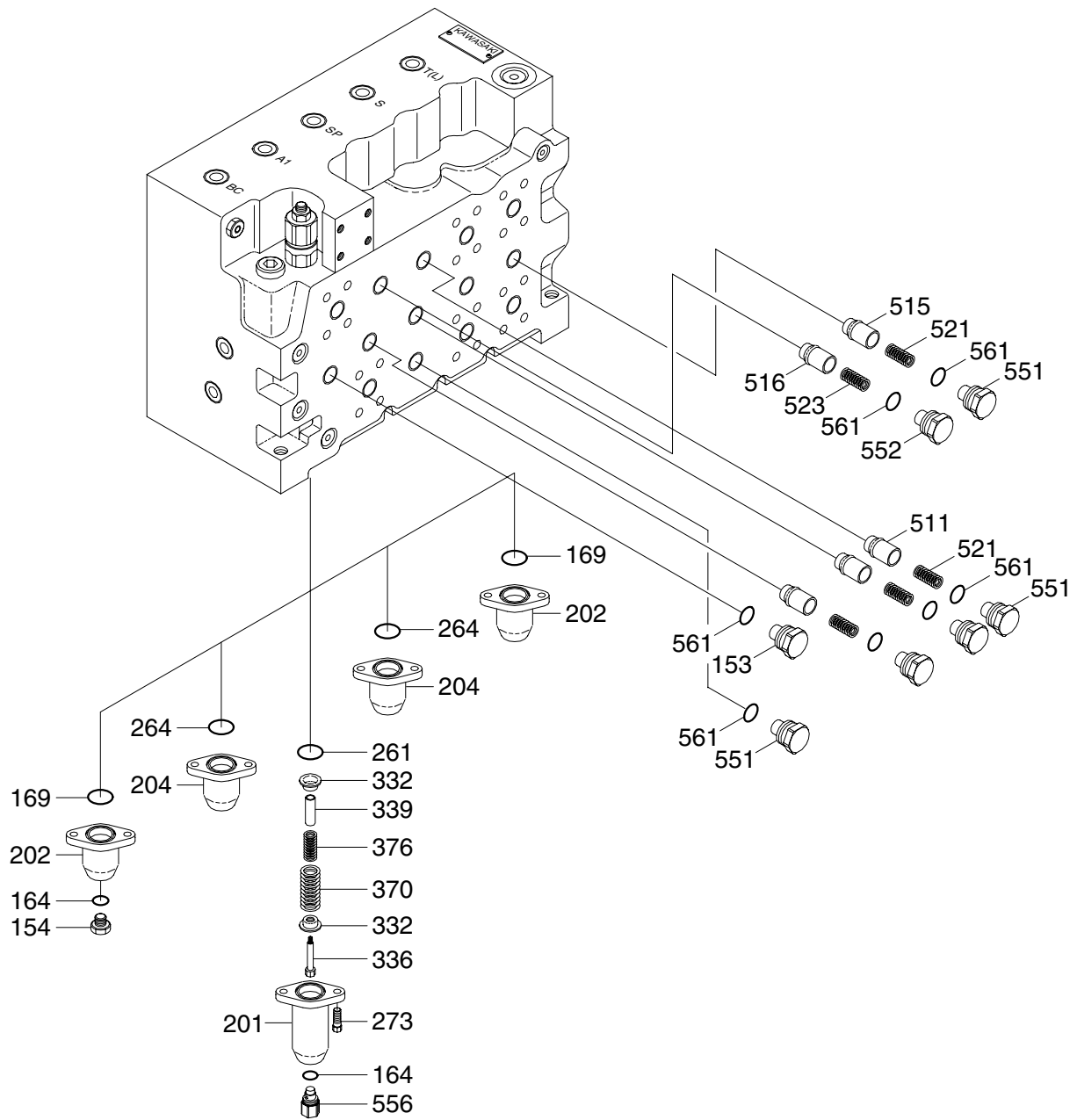

- 153 Plug
- 154 Plug
- 164 O-ring
- 169 O-ring
- 201 Cover
- 202 Cover
- 204 Cover
- 261 O-ring

- 264 O-ring
- 273 Socket screw
- 332 Seat
- 336 Bolt
- 339 Stopper
- 370 Spring
- 376 Spring
- 511 Poppet

- 515 Poppet
- 516 Poppet
- 521 Spring
- 523 Spring
- 551 Plug
- 552 Plug
- 556 Plug
- 561 O-ring

21078MC06

STRUCTURE(4/5)

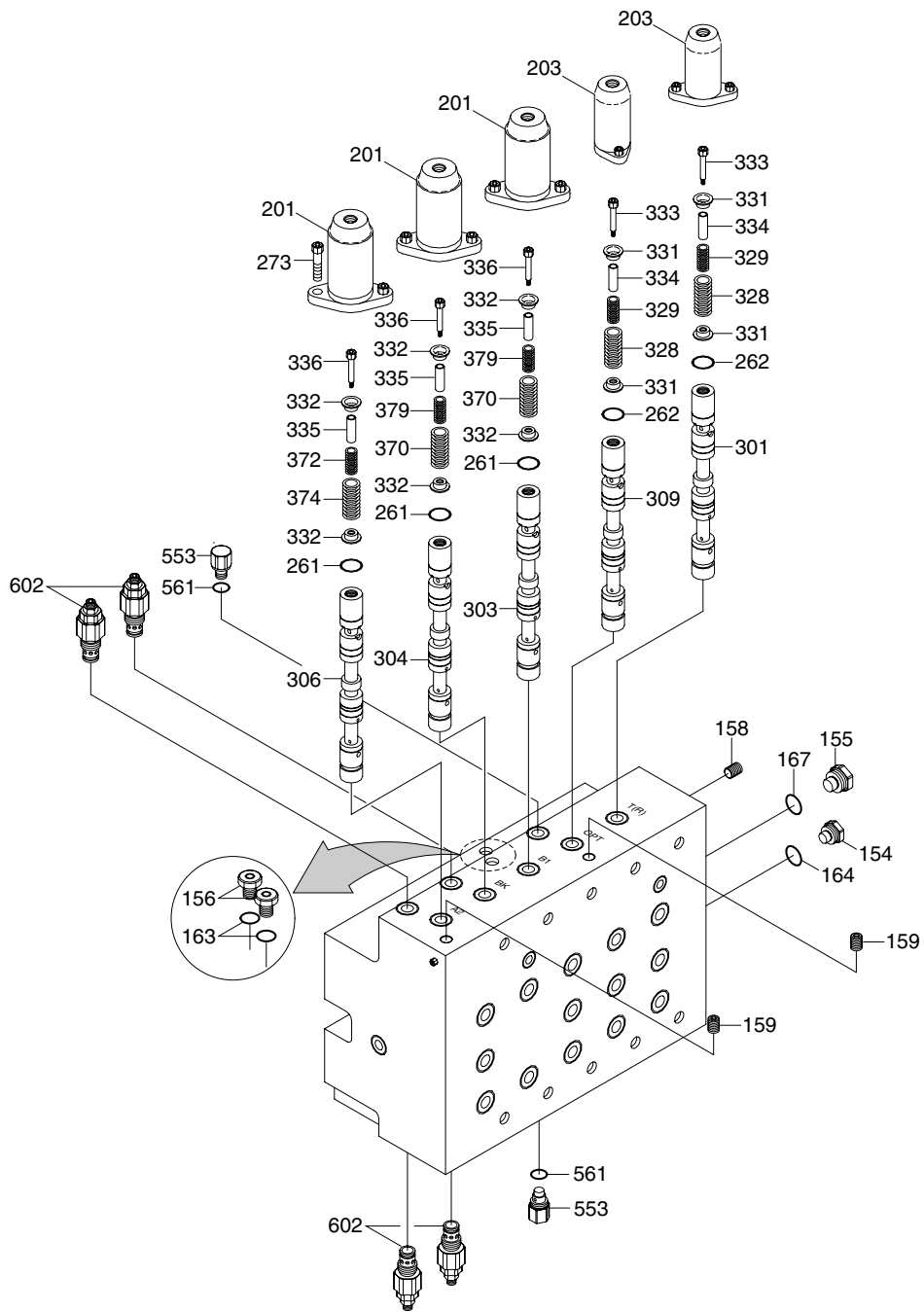

21078MC07

- | | | |
|------------|------------------|-----------------------|
| 154 Plug | 273 Socket screw | 334 Stopper |
| 155 Plug | 301 Travel spool | 335 Stopper |
| 156 Plug | 303 Boom1 spool | 336 Bolt |
| 158 Plug | 304 Bucket spool | 370 Spring |
| 159 Plug | 306 Arm2 spool | 372 Spring |
| 163 O-ring | 309 Option spool | 374 Spring |
| 164 O-ring | 328 Spring | 377 Spring |
| 167 O-ring | 329 Spring | 379 Spring |
| 201 Cover | 331 Seat | 553 Plug |
| 203 Cover | 332 Seat | 561 O-ring |
| 261 O-ring | 333 Bolt | 602 Port relief valve |
| 262 O-ring | | |

STRUCTURE(5/5)

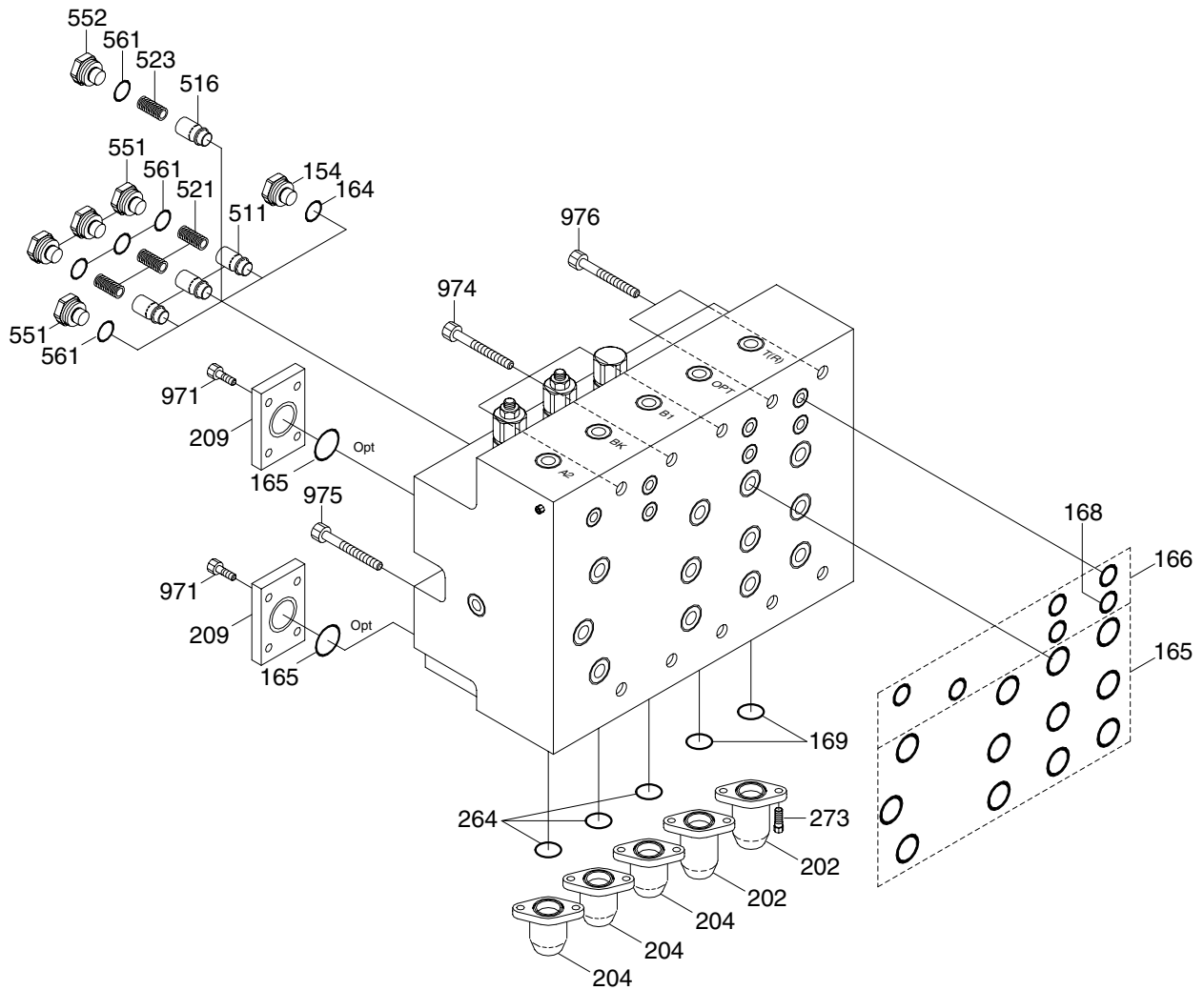

21078MC08

- | | | |
|------------|------------------|------------|
| 154 Plug | 209 Flange | 551 Plug |
| 164 O-ring | 264 O-ring | 552 Plug |
| 165 O-ring | 273 Socket screw | 561 O-ring |
| 166 O-ring | 511 Poppet | 971 Screw |
| 168 O-ring | 516 Poppet | 974 Screw |
| 169 O-ring | 521 Spring | 975 Screw |
| 202 Cover | 523 Spring | 976 Screw |
| 204 Cover | | |

3. DISASSEMBLY AND ASSEMBLY

1) GENERAL PRECAUTIONS

- (1) All hydraulic components are manufactured to a high precision. Consequently, before disassembling and assembling them, it is essential to select an especially clean place.
- (2) In handling a control valve, pay full attention to prevent dust, sand, etc. from entering into it.
- (3) When a control valve is to be removed from the machine, apply caps and masking seals to all ports. Before disassembling the valve, recheck that these caps and masking seals are fitted completely, and then clean the outside of the assembly. Use a proper bench for working. Spread paper or a rubber mat on the bench, and disassemble the valve on it.
- (4) Support the body section carefully when carrying or transferring the control valve. Do not lift by the exposed spool, end cover section etc.
- (5) After disassembling and assembling of the component it is desired to carry out various tests (For the relief characteristics, leakage, flow resistance, etc.), but hydraulic test equipment is necessary for these tests. Therefore, even when its disassembling can be carried out technically, do not disassemble such components that cannot be tested, adjusted, and so on. Additionally one should always prepare clean cleaning oil, hydraulic oil, grease, etc. beforehand.

2) TOOLS

Before disassembling the control valve, prepare the following tools beforehand.

| Name of tool | Quantity | Size(mm) |
|----------------------------------|--------------|-----------------------|
| Vice mounted on bench(Soft jaws) | 1 unit | |
| Hexagon wrench | Each 1 piece | 5, 6, 10, 12 and 14 |
| Socket wrench | Each 1 piece | 27 and 32 |
| Spanner | Each 1 piece | 32(Main relief valve) |

3) DISASSEMBLY

The figure in () shown after the part name in explanation sentence shows its number in the construction figures.

(1) Place control valve on working bench

- ※ Disassemble the valve in a clean and dry environment and pay careful attention not to damage the sealing flange faces.

(2) Travel straight valve block

Loosen hexagon socket head bolts to and remove straight travel valve block(103) in its assembled state.

- Hexagon wrench : 14mm

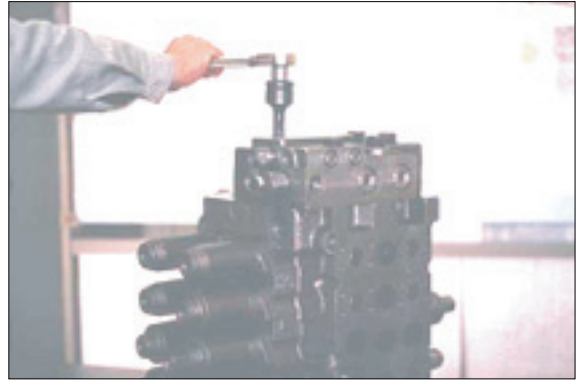

21078MC09

(3) Main spool

- ① Loosen hexagon socket head bolts(273) and remove spring cover(201, 203).

- Hexagon wrench : 6mm



21078MC10

- ② Remove spool, springs, stopper, spring seats and spacer bolt in spool assembly condition from casing.

- ※ When extracting each spool assembly from its casing, pay attention not to damage the casing.



21078MC11

(4) Covers

Loosen hexagon socket head bolts(273) and then remove the spool cover(202, 204).

- Hexagon wrench : 6mm



21078MC12

(5) Removal of port relief

Remove port relief valves(602) from casing.

- Socket wrench : 32mm



21078MC13

(6) Removal of plug(Option section)

Remove plugs(553) from casing.

- Socket wrench : 27mm

(7) Lock valve

Loosen hexagon socket head bolts and remove lock valve(252).

- Hexagon wrench : 5mm



21078MC14

(8) Negative control relief valve

- ① Remove plug(551).
 - Hexagon wrench : 12mm



21078MC15

- ② Remove poppet(611), spring(621) and damping rod(631).



21078MC16

(9) Swing logic valve and check valve

- ① Loosen hexagon socket head bolts(251) and remove logic valve(251) and take check valve(254).
- ② Remove plug(551) or (552) and take out poppet(511) or (515, 516) and spring (521) or (523).
 - Hexagon wrench : 6, 12mm

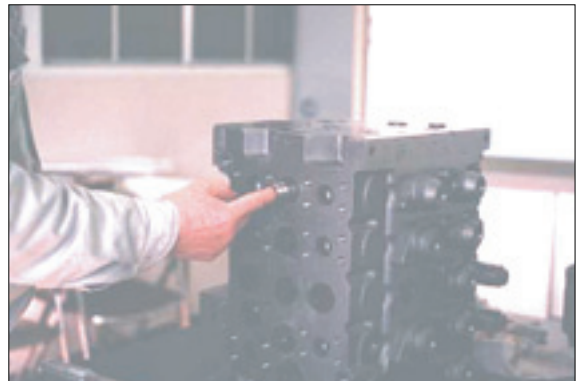

21078MC17

(10) Boom priority valve

- Loosen hexagon socket head bolts(104) and remove boom priority valve(104).
 - Hexagon wrench : 10mm

(11) Inspection after disassembly

Clean all disassembled parts with clean mineral oil fully, and dry them with compressed air. Then, place them on clean papers or cloths for inspection.

① Control valve

- a. Check whole surfaces of all parts for burrs, scratches, notches and other defects.
- b. Confirm that seal groove faces of casing and block are smooth and free of dust, dent, rust etc.
- c. Correct dents and damages and check seat faces within the casing, if any, by lapping.
※ Pay careful attention not to leave any lapping agent within the casing.
- d. Confirm that all sliding and fitting parts can be moved manually and that all grooves and paths are free foreign matter.
- e. If any spring is broken or deformed, replace it with new one.
- f. When a relief valve does not function properly, repair it, following it's the prescribed disassembly and assembly procedures.
- g. Replace all seals and O-rings with new ones.

② Relief valve

- a. Confirm that all seat faces at ends of all poppets and seats are free of defects and show uniform and consistent contact faces.
- b. Confirm manually that main poppet and seat can slide lightly and smoothly.
- c. Confirm that outside face of main poppet and inside face of seat are free from scratches and so on.
- d. Confirm that springs are free from breakage, deformation, and wear.
- e. Confirm that orifices of main poppet and seat section are not clogged with foreign matter.
- f. Replace all O-rings with new ones.
- g. When any light damage is found in above inspections, correct it by lapping.
- h. When any abnormal part is found, replace it with a completely new relief valve assembly.

4) ASSEMBLY

(1) General comments

- ① In this assembly section, explanation only is shown.
For further understanding, please refer to the figures and photographs shown in the previous structure & disassembly section.
- ② Figure in () shown after the part name in the explanation refers to the reference identity number shown on the structure section.
- ③ **Cautions in assembling seals**
 - a. Pay close attention to keeping all seals free from handling damage and inspect carefully for damage before using them.
 - b. Apply clean grease or hydraulic oil to the seal so as to ensure it is fully lubricated before assembly.
 - c. Do not stretch seals so much as to deform them permanently.
 - d. In fitting O-rings, pay close attention not to roll them into their final position in addition, a twisted O-ring cannot easily untwist itself naturally and could thereby cause inadequate sealing and thereby both internal and external oil leakage.
 - e. Tighten fitting bolts for all sections with a torque wrench adjusted to the respective tightening torque.

(2) Check valve

- ① Assemble poppet(511, 515, 516) and spring(521, 523).
- ② Put O-rings(561) on to plug(551, 552).
- ③ Tighten plug(551, 552) to the specified torque.
 - Hexagon wrench : 12mm
 - Tightening torque : 23~27kgf · m(166~195lbf · ft)

(3) Negative control relief valve

- ① Assemble the poppets, springs and damping rods(2×611) together into casing A(101).
- ② Put O-ring(561) on to plug(551) and tighten the latter to its specified torque.
 - Hexagon wrench : 12mm
 - Tightening torque : 23~27kgf · m(166~195lbf · ft)

(4) Lock valve

- ① Put O-rings onto the casing.
- ② Tighten hexagon socket head bolts to their specified torques.
 - Hexagon wrench : 5mm
 - Tightening torque : 1~1.4kgf · m(7.23~10.12lbf · ft)

(5) Main relief, port relief valves

Install main relief valve(601), port relief valve(602) into the casing and tighten to the specified torque.

| Component | Tools | Tightening torque | |
|-------------------|--------------------|-------------------|-----------|
| | | kgf · m | lbf · ft |
| Main relief valve | Spanner 32mm | 7~8 | 50.6~57.8 |
| Port relief valve | Socket wrench 32mm | 7~8 | 50.6~57.8 |

(6) Main spools

- ① Carefully insert the previously assembled spool assemblies into their respective bores within of casing A(101) and casing B(102).
- ※ Fit spool assemblies into casing A(101) and casing B(102) carefully and slowly. Do not under any circumstances push them forcibly in.

(7) Covers

- ① Fit spool covers(202, 204) to the non-spring assembly end of the spool, and tighten the hexagonal socket head bolts(273) to the specified torque.
 - Hexagon wrench : 6mm
 - Tightening torque : 2.5~3.5kgf · m(18~25.3lbf · ft)
- ※ Confirm that O-rings(169, 264) have been fitted.
- ② Fit spring covers(201, 203) to the spring end for the spools, and tighten hexagon socket head bolts(273) to the specified torque.
 - Hexagon wrench : 6mm
 - Tightening torque : 2.5~3.5kgf · m(18~25.3lbf · ft)
- ※ Confirm that O-rings(261, 262) have been fitted.

(8) Travel straight valve, swing logic valve and boom priority valve

- ① Put O-rings onto the casing.
- ② Tighten hexagon socket head bolts to their specified torques.

| Component | Tools | Tightening torque | |
|-----------------------|---------------------|-------------------|-----------|
| | | kgf · m | lbf · ft |
| Travel straight valve | Hexagon wrench 14mm | 28.0~32.0 | 202~231 |
| Swing logic valve | Hexagon wrench 6mm | 2.5~3.5 | 18.0~25.3 |
| Boom priority valve | Hexagon wrench 10mm | 8.5~11.5 | 61.5~83.1 |