

GROUP 12 PUMP PROLIX

Its the conversion connector to manual control temporarily when the electronic control system is out of order, until repair work be done.

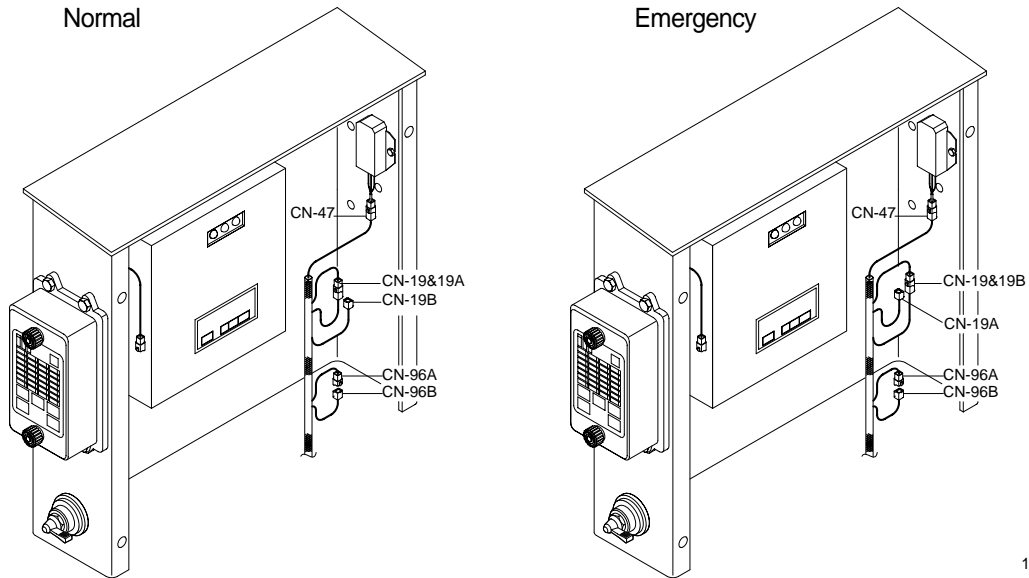

16075MS12

1. OPERATING PRINCIPLE WIRING DIAGRAM

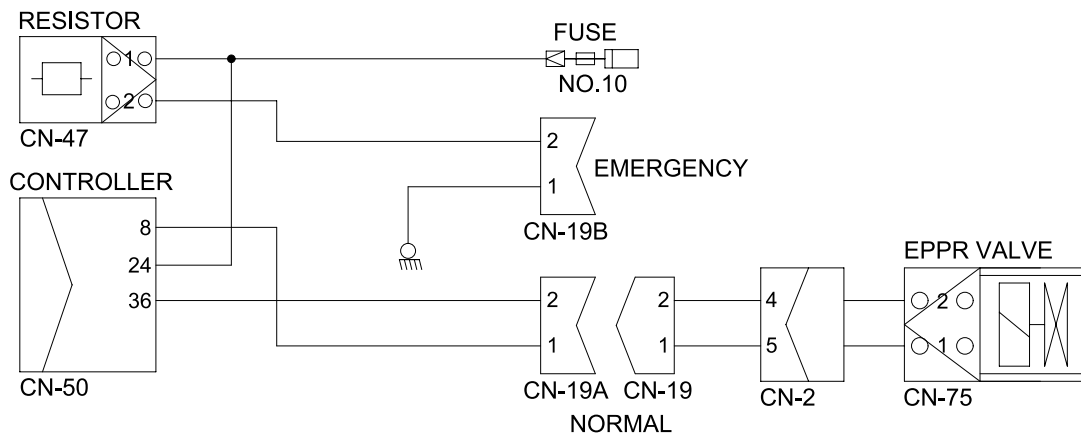

16075MS30

1) NORMAL

- EPPR valve supply specified amount of pilot pressure to the flow regulator of hydraulic pump and regulate hydraulic pump delivery amount depending upon the signal of CPU controller by selected mode.

2) EMERGENCY

- If prolux resistor(CN-19) is connected with CN-19B when any abnormality occurs in NEW CAPO system, constant electric current from battery flows to EPPR valve so that EPPR valve can be fixed at the predetermined position.
- In this case excavator can be operated at an equivalent performance to S mode.